

INDUSTRIAL FANS CATÁLOGO GENERAL





Ventiladores diseñados para satisfacer todo tipo demandas de aplicación industrial.

Se instalan principalmente en los sistemas de acondicionamiento civil e industrial, en las plantas de secado, en cabinas de pintura, calderas, hornos, quemadores industriales, depuración de gases, transportes de material, cementeras, atmósferas explosivas ATEX, Oil&Gas y otros.

CONTROL

El control integral de todo el proceso de fabricación nos permite ofrecer la más alta calidad exigida para este tipo de producto.

Las turbinas se equilibran estática y dinámicamente utilizando equipos electrónicos según las normas de ISO 1940 grado G=6.3. Los parámetros de prestación de los ventiladores se han medido con tubos de salida según las normas UNI 7179-73 y las normas AMCA 210-85. Las prestaciones de nuestros ventiladores son de clase tolerancia 2 según las normas DIN 24 166, y Clase AN3, según normas ISO/CD 13348.2.





Durante años se ha invertido de forma constante, en el desarrollo de procesos y aplicaciones internas, para conseguir la fabricación y el suministro de ventiladores industriales especiales, con un tiempo de diseño y fabricación extremadamente reducido.

El trabajo en equipo de nuestro departamento de ingeniería, junto con universidades y centros tecnológicos, así como la estrecha colaboración entre los departamentos de diseño de nuestros colaboradores externos, hace posible conseguir innovadoras soluciones de ventilación industrial en un corto plazo de tiempo.

A lo largo de nuestra historia hemos desarrollado todo tipo de tecnología en ventiladores para aplicaciones industriales que actualmente están repartidos por todo el mundo, nuestro objetivo es seguir invirtiendo en este sector para seguir siendo uno de los fabricantes de ventiladores industriales más reconocidos en el mundo.

ROBUSTEZ

Su robusta construcción es una de sus características principales.

Los cojinetes se han dimensionado para una vida útil mínima de 40.000 horas; correas y poleas dimensionadas para trabajos continuados, protección de las transmisiones cerradas, bancadas soporte, los espesores de las chapas y la posición de los soportes y de los refuerzos han sido especialmente analizados para garantizar la ausencia de vibraciones.

TEMPERATURAS DE TRABAJO

Ventiladores de accionamiento directo con turbina directamente acoplada a eje motor, sin rodete de refrigeración, capaz de trasegar aire hasta +120°C. Construcciones especiales hasta +250°C. Ventiladores a transmisión con rodete de refrigeración capaz de trasegar aire hasta +300°C y hasta +450°C con construcción especial bajo demanda.

BAJO DEMANDA

Podemos ofrecer ventiladores especiales para acerías, cementeras, aplicaciones especiales, materiales especiales, alta temperatura, antidesgaste, etc.

Válvulas de regulación de caudal en impulsión/ aspiración de accionamiento manual, neumático o eléctrico. Formas constructivas 7 y 8 según AMCA Standard 99-2404-03 están igualmente disponibles.



APLICACIONES



Industriales

Calderas industriales, plantas de secado, hornos, quemadores industriales, depuración de gases, transportes de material, cementeras, atmósferas explosivas ATEX, Oil&Gas, son algunas de las aplicaciones de este tipo de ventiladores.

Navales / Off-shore

Nuestros extractores son reconocidos por su calidad y buen funcionamiento por la mayoría de constructores de barcos y empresas de defensa civil del mundo.



Los extractores bajo demanda pueden cumplir con los diferentes requerimientos de las sociedades de clasificación y certificación. Posibilidad de ofrecer Design Approval Certificate de diferentes entidades navales bajo demanda.

Los motores marinos utilizados están certificados por la mayoría de entidades internacionales de clasificación naval.



Atmósferas explosivas ATEX

Todos nuestros extractores y ventiladores para atmósferas explosivas cumplen con las exigencias de la directiva europea 2014/34/UE.

Además, se han diseñado de acuerdo a la norma EN-14986 “Diseño de ventiladores para trabajar en atmósferas potencialmente explosivas”.

De esta forma se garantiza la calidad de los productos y se asegura al máximo la seguridad de las personas e instalaciones.

Mineras / Obras públicas

La amplia gama de productos nos permite ofrecer soluciones para la ventilación de túneles durante y después de su proceso de construcción.

Extractores helicoidales tubulares de alta presión y gran robustez, especialmente diseñados para instalaciones de minería, navales o aplicaciones con grandes pérdidas de carga. Ventiladores tubulares bifurcados para trasegar aire hasta 150°C en continuo.

Son algunas de nuestras variantes perfectamente adaptadas para trabajos a realizar donde las condiciones ambientales, movimientos de tierras o la difícil extracción de gases son claves para mantener la seguridad en el lugar de trabajo de los profesionales.

Standards compliance for railway and rolling equipment



Related standards:

GOST 30630.0.0-99

Environment stability test methods for machines, instruments and other industrial products.

GOST 28231-89

(IEC 68-2-47-82) Basic methods of testing for exposure to external factors. Part 2. Testing. Fastening of elements, tools and other products in the course of dynamic testing. Including shock (Ea), multiple shock (Eb), vibration (Fc and Fd), linear acceleration (Ga) and Guidance.

GOST 30630.1.1-99

Methods of testing for resistance of machinery, instruments and other technical products to externally acting mechanical factors. Determining dynamic characteristics of a structure.

GOST 30630.1.2-99

Methods of testing for resistance of machinery, instruments and other technical products to externally acting mechanical factors. Vibration testing. Testing for stability under exposure to sinusoidal or accidental wide-band

vibration. Long-run testing for durability under exposure to sinusoidal or accidental wide-band vibration (long-run chatter testing). Testing for durability under exposure to multiple mechanical shocks (shock strength testing).

GOST 30631-99

General requirements to machinery, instruments and other technical products with regard to resistance to externally acting mechanical factors during operation.

GOST 17516.1

1990-MAY-23

Electrotechnical articles general requirements for stability to effect of environmental mechanical factors – Incorporates Amendment 1: 11/21/1997

UNE-EN 61373

Aplicaciones Ferroviarias, Material rodante, Ensayos de choque y vibración.

Railway applications. Rolling equipment. Shock and vibration tests

Vibrations

The table presented below shows the vibration requirements for mounted equipment in A-Class vehicle. Sodeca fans complies with GOST vibration requirements, which are the most restrictive.

EN STANDARD					
Standard number	Vibration type	Vibration RMS X Axis [m/s ²]	Vibration RMS Y Axis [m/s ²]	Vibration RMS Z Axis [m/s ²]	Vibration frequency [Hz]
EN 61373-2011	Increased random vibrations	2,83	2,09	4,25	-
	Standard random vibrations	0,50	0,37	0,75	-

GOST STANDARD					
Standard number	Vibration type	Vibration amplitude X Axis [m/s ²]	Vibration amplitude Y Axis [m/s ²]	Vibration amplitude Z Axis [m/s ²]	Vibration frequency [Hz]
GOST 17516.1-1990 + GOST 16692.2 & GOST 30631-1999 + GOST 30630.0.0	Long term sinusoidal vibrations	15	15	15	10-100
	Short term sinusoidal vibrations	10	10	10	10-100

The next two figures show displacement and stress maps for a Sodeca fan under the vibration required by GOST standard in the Y axis. The test method consists in 687 repetitions 7 minutes long. The vibration is simulated with a sinusoidal acceleration of 15 m/s² amplitude and frequency 100 Hz. At the end of the test the fan has to endure 28.8 million cycles.

Fan's displacement map after the test. The displacement that is shown in the image has been increased to make it visible. The maximum displacement is 1.06 mm.



Fan's stress map after the test. The maximum stress is 69.7 MPa for steel parts and 65 MPa for aluminium parts. It is the maximum for all axes.



The next two figures shows displacement and stress maps for a Sodeca fan under the impact requirement of UNE-EN-61373 standard. The fan receives an impact with 30 m/s² acceleration and 30 ms duration in the Y axis.

Fan's displacement map after impact. The displacement that is shown in the image has been increased to make it visible. The maximum displacement is 0.12 mm.

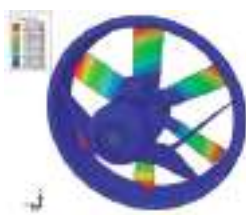

Fan's stress map after the impact. The maximum stress is 23.5 MPa for all axes; it is situated in the steel frame.



The cast aluminium's fatigue limit for 28.8 million cycles is about 80 MPa. All Aluminium parts have a stress below 65 MPa, so all this parts meet the requirements. The steel's fatigue limit is much higher than aluminium, so all steel parts meets too the requirements.

The test result confirms that the fan can resist the impact required by the standard, because 23.5 MPa is a stress value too low for steels.



ASCAMM technology centre studies Sodeca fans to assure the compliance with GOST and EN standards for products mounted in railway and rolling equipment. ASCAMM uses numerical simulations to check the fan design under the vibration and shock conditions required by the standards.

Impacts

The table presented below shows the impact requirements for mounted equipment in A-Class vehicle. Sodeca fans complies UNE-EN-61373 impact requirements which are the most restrictive.

Impact requirements UNE-EN 61373	
Acceleration X Axis [m/s ²]	50
Acceleration Y Axis [m/s ²]	30
Acceleration Z Axis [m/s ²]	30
Duration [m/s]	30

GOST 17516.1-1990 + GOST 16692.2
& GOST 30631-1999 + GOST 30630.0.0
30 m/s² (only one axis) Duration: 2-20 ms



SMALL SERIES

16

MEDIA PRESIÓN		ALTA PRESIÓN		TRANSPORTE	
	18		26		47
CMP Ventiladores centrífugos de media presión equipados con turbina en chapa de acero		CMPE Ventiladores centrífugos de media presión y simple aspiración con motor de rotor exterior		CA Ventiladores centrífugos de alta presión y simple aspiración con envolvente y turbina en fundición de aluminio	
	28		31		51
CRL Ventiladores centrífugos de media presión y simple aspiración con turbina a reacción		CMR Ventiladores centrífugos de media presión y de gran robustez		CAS Ventiladores centrífugos de alta presión en chapa de acero	
	36		36		51
CBP Ventiladores centrífugos de media presión		CBPC Ventiladores centrífugos de media presión con turbina a reacción y salida vertical		CAS-S Ventiladores centrífugos de alta presión en chapa de acero con atenuador acústico	
	38		42		60
CMA Ventiladores centrífugos de media presión y simple aspiración con envolvente y turbina en fundición de aluminio		CPV Ventiladores centrífugos anticorrosivos de material plástico		CAM Ventiladores centrífugos de alta presión con turbina en fundición de aluminio	
					64
					66
					69
					72
				CMTS Ventiladores centrífugos de media presión, simple aspiración y turbina de pala recta para transporte de humo y sólidos	
				CMT Ventiladores centrífugos de simple aspiración y turbina de pala recta para transporte de humo y sólidos	
				CMAT Ventiladores centrífugos de media presión para transporte de sólidos	
				PORT Extractores de aire portátiles de gran potencia y robustez	



LARGE SERIES

74

MEDIA PRESIÓN	ALTA PRESIÓN	TRANSPORTE
 <p>CMRS 76 Ventiladores centrífugos de media presión y simple aspiración, de gran robustez, equipados con turbina a reacción</p>	 <p>CASB 190 Ventiladores centrífugos de alta presión y simple aspiración de gran robustez con envolvente y turbina en chapa de acero</p>	 <p>CAST 266 Ventiladores centrífugos de pala abierta y simple aspiración de gran robustez con envolvente y turbina en chapa de acero</p>
 <p>CAMA 110 Ventiladores centrífugos de media presión y simple aspiración de gran robustez con envolvente y turbina en chapa de acero</p>	 <p>CAAB 222 Ventiladores centrífugos de alta presión y simple aspiración de gran robustez con envolvente y turbina en chapa de acero</p>	 <p>CMTB 282 Ventiladores centrífugos de pala abierta y simple aspiración de gran robustez con envolvente y turbina en chapa de acero</p>
 <p>CAMC 144 Ventiladores centrífugos de media presión y simple aspiración de gran robustez con envolvente y turbina en chapa de acero</p>	 <p>CAAE 240 Ventiladores centrífugos de alta presión y simple aspiración de gran robustez con envolvente y turbina en chapa de acero</p>	 <p>CMTC 294 Ventiladores centrífugos de pala abierta y simple aspiración de gran robustez con envolvente y turbina en chapa de acero</p>
 <p>CAMD 160 Ventiladores centrífugos de media presión y simple aspiración de gran robustez con envolvente y turbina en chapa de acero</p>	 <p>CAAF 252 Ventiladores centrífugos de alta presión y simple aspiración de gran robustez con envolvente y turbina en chapa de acero</p>	



Ventiladores para hornos

308

VENTILADORES PARA HORNOS DE PANADERÍA Y PASTERERÍA



310

SDECB/M

Ventiladores centrífugos especialmente diseñados para la extracción de aire caliente máx. 80 °C y vapores de agua en campanas de extracción, con salida de aire vertical



312

SDECB/O

Ventiladores centrífugos construidos en INOX especialmente diseñados para la extracción de aire caliente máx. 80 °C y vapores de agua en campanas de extracción, con salida de aire horizontal



313

SDBP/F

Ventiladores centrífugos construidos en INOX especialmente diseñados para la extracción de aire caliente máx. 80 °C y vapores de agua en campanas de extracción, con salida de aire horizontal



314

SDBP/M INOX

Ventiladores centrífugos construidos en INOX especialmente diseñados para la extracción de aire caliente máx. 80 °C y vapores de agua en campanas de extracción, con salida de aire vertical y construcción inoxidable



315

SDECB/MGC

Ventiladores centrífugos especialmente diseñados para la recirculación de aire caliente en hornos máx. 300 °C



316

SDECB/Z

Ventiladores centrífugos especialmente diseñados para la extracción de aire caliente máx 300 °C en campanas de extracción, con salida de aire vertical



318

SDLM/F

Ventiladores centrífugos especialmente diseñados para la extracción de aire caliente en hornos máx. 300 °C y salida de aire horizontal



320

CMRH

Ventiladores accionados a transmisión, equipados con motor eléctrico, conjunto de poleas, correas y protectores normalizados según norma ISO-13857 y cajón calorifugado con fibra mineral de 150 mm, para trabajo horizontal



325

CMSH

Ventiladores centrífugos de media presión, equipados con turbina a reacción y cajón calorifugado con fibra mineral



329

CMPH

Ventiladores centrífugos de media presión, equipados con turbina a acción y cajón calorifugado con fibra mineral



332

HPX

Ventiladores helicoidales tubulares, con motor exterior



335

HBA

Ventiladores helicoidales tubulares bifurcados, con motor fuera del flujo de aire

Ventiladores y sus aplicaciones



Clasificación	Aplicación		
MEDIA PRESIÓN Para aire con polvo	<ul style="list-style-type: none"> · Cabinas de pintura · Secadores · Calderas · Conservación cereales en años · Refrigeración de motores · Ventilación de naves · Ventilación en aplicaciones de compostaje · Sistemas de calderas · Filtros de tambor 	<ul style="list-style-type: none"> · Instalaciones de aspiración · Industria química · Transporte neumático · Hornos de cocción de cerámica · Molinos · Templado de vidrio · Fabricante de vidrio · Hornos de pan · Ventilación en procesamiento de lácteos 	<ul style="list-style-type: none"> · Extractores de cocina industrial · Extracción de aire en vertederos · Empresas farmacéuticas · Conservación de cereales en silos · Ventilación de minas · Colectores de polvo · Incineradoras
ALTA PRESIÓN Para aire con polvo	<ul style="list-style-type: none"> · Instalaciones para fundiciones · Instalaciones cementeras · Industria del mármol · Hornos de cocción 	<ul style="list-style-type: none"> · de cerámica · Hornos · Tabacos · Biomasa · Sistemas de vacío 	<ul style="list-style-type: none"> · Transporte neumático · Recirculación de gases de combustión
TRANSPORTE Para aire muy polvoriento con pedazos y granulados	<ul style="list-style-type: none"> · Maquinaria textil 	<ul style="list-style-type: none"> · Carpinterías 	<ul style="list-style-type: none"> · Fábricas de papel
HORNOS DE PANADERÍA Y PASTELERÍA	<ul style="list-style-type: none"> · Hornos de pan · Hornos de pastelería 	<ul style="list-style-type: none"> · Hornos en general · Maquinaria con temperatura 	<ul style="list-style-type: none"> · Tratamiento de superficies
HORNOS INDUSTRIALES	<ul style="list-style-type: none"> · Hornos industriales · Secadores de hornos 	<ul style="list-style-type: none"> · Ventilación y extracción en laboratorios 	<ul style="list-style-type: none"> · Cabinas de pintura · Tratamiento de superficies

Información general



Variantes constructivas SMALL SERIES y HORNOS

Ventiladores centrifugos para aplicaciones industriales SMALL SERIES

VERSIÓN STANDARD

-25°C / +120° C

VERSIÓN ALTA TEMPERATURA

-25°C / +250°C

- . Con turbina de refrigeración en el eje del motor y el motor separado de la carcasa del ventilador, en el caso de motor directo.
- . Con turbina de refrigeración montada el eje soporte, entre el rodamiento y la carcasa del ventilador, en el caso de modelos a transmisión.
- . En algunas series, se aplicara pintura anti calórica en la turbina o ventilador, según aplicación.

Ventiladores para HORNOS

- . Las construcciones de ventiladores para hornos de panadería y pastelería están preparados para trabajo con alta temperatura hasta +300°C
- . Las construcciones de ventiladores para hornos industriales comprenden temperaturas de trabajo máximas entre +90°C hasta +300°C, según construcción y modelos.

Orientación SMALL SERIES y HORNOS

La orientación de un ventilador visto del lado opuesto a la boca de aspiración, esta designado con la sigla LG si el sentido del aire es antihorario y RD si es horario. El ángulo de rotación está expresado en grados y medido des de el eje de la boca de impulsión y la perpendicular a la base de apoyo.

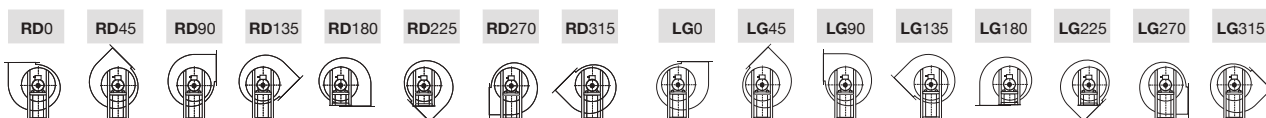

Variantes constructivas LARGE SERIES



Versión Atex

Si el ventilador transporta mezclas explosivas es necesaria la adopción de la versión ATEX. El cliente siempre debe indicar el área de uso, el gas (indicando que tipo) o polvo.

Versión alta temperatura

Ventiladores centrífugos para aplicaciones industriales LARGE SERIES

VERSIÓN STANDARD -25°C / +90°C	VERSIÓN ALTA TEMPERATURA -25°C / +150°C	VERSIÓN ALTA TEMPERATURA -25°C / +300°C
Sistema: 1, 4, 5, 8, 9, 12	Sistema 4, 5	Sistema 1, 8, 9, 12
	<ul style="list-style-type: none"> Con turbina de refrigeración en el eje del motor y el motor separado de la carcasa del ventilador. Pintura de aluminio resistente a la temperatura Bajo demanda ejecuciones especiales para temperaturas de +450°C 	<ul style="list-style-type: none"> Con turbina de refrigeración montada el eje soporte, entre el rodamiento y la carcasa del ventilador. Rodamiento cercano a la turbina, en tolerancia C-3 Pintura de aluminio resistente a la temperatura

Formas constructivas LARGE SERIES

<p>SISTEMA 1</p>  <p>SISTEMA 1 Accionamiento a transmisión, turbina montada en el eje soporte. Soporte montado sobre la silleta.</p>	<p>SISTEMA 4</p>  <p>SISTEMA 4 Accionamiento directo, turbina montada en el eje motor, montado sobre la silleta.</p>	<p>SISTEMA 5</p>  <p>SISTEMA 5 Accionamiento directo, turbina montada en el eje motor, motor de brida montado sobre la carcasa del ventilador.</p>
<p>SISTEMA 8</p>  <p>SISTEMA 8 Accionamiento por acoplamiento elástico, turbina montada en el eje soporte, montado al motor mediante acoplamiento elástico. Todo montado conjuntamente sobre la silleta ventilador. Para dimensiones consultar con nuestro departamento técnico.</p>	<p>SISTEMA 9</p>  <p>SISTEMA 9 Accionamiento a transmisión, igual a la SISTEMA 1, con el motor montado en el lateral de la silleta, en posición "W" o "Z".</p>	<p>SISTEMA 12</p>  <p>SISTEMA 12 Accionamiento a transmisión, igual a la SISTEMA 1, con el motor y ventilador montados en la bancada común. Posiciones de motor "W" o "Z" y excepcionalmente "X" o "Y".</p> <p><i>Posiciones del motor</i></p>

Orientación LARGE SERIES

La orientación de un ventilador visto del lado opuesto a la boca de aspiración, esta designado con la sigla LG si el sentido del aire es antihorario y RD si es horario. El ángulo de rotación está expresado en grados y medido des de el eje de la boca de impulsión y la perpendicular a la base de apoyo.



CUMPLIMIENTO DE NORMAS

Los ventiladores y extractores de SODECA, cumplen con las siguientes normativas:

CUMPLIMIENTO

ISO 9001:2015	Sistemas de gestión de la calidad. Requisitos. Quality management systems -- Requirements.
----------------------	---

ENSAYOS

UNE-EN ISO 5801	Ventiladores. Ensayos de comportamiento en circuitos normalizados. Fans -- Performance testing using standardized airways.
AMCA 210-16	Ventiladores industriales. Métodos de ensayos de ventiladores y su representación de ensayos. Laboratory Methods of Testing Fans for Aerodynamic Performance Rating.
UNE-EN ISO 13350	Ventiladores. Ensayos de comportamiento de ventiladores de chorro. Fans -- Performance testing of jet fans.
ISO 13348	Industrial fans -- Tolerances, methods of conversion and technical data presentation.

VENTILADORES PARA ALTA TEMPERATURA

UNE EN 12101-3	Sistemas de control de humos y calor. Parte 3: Especificaciones para aireadores extractores de humos y calor mecánicos. Smoke and heat control systems - Part 3: Specification for powered smoke and heat exhaust ventilators.
-----------------------	---

ACÚSTICA

UNE EN ISO 3744	Acústica - Determinación de los niveles de potencia acústica y de los niveles de energía acústica de fuentes de ruido utilizando presión acústica. Métodos de ingeniería para un campo esencialmente libre sobre un plano reflectante. Acoustics - Determination of sound power levels and sound energy levels of noise sources using sound pressure - Engineering methods for an essentially free field over a reflecting plane
------------------------	---

EQUILIBRADO Y VIBRACIONES

ISO 21940-11	Vibraciones mecánicas. Calidad de equilibrado. Mechanical vibration – rotor balancing - Part 11: Procedures and tolerances for rotors with rigid behaviour
ISO 20816-1	Vibraciones mecánicas. Evaluación de las vibraciones de máquinas. Mechanical vibration – measurement and evaluation of machine vibration – Part 1: General guidelines
ISO 14694	Ventiladores industriales. Especificaciones para equilibrado y niveles de vibración. Industrial fans -- Specifications for balance quality and vibration levels.

SEGURIDAD (Declaración de Conformidad CE)

UNE EN ISO 12100	Seguridad de las máquinas. Principios generales para el diseño. Evaluación del riesgo y reducción del riesgo. Safety of machinery - General principles for design - Risk assessment and risk reduction
UNE EN 60204-1	Seguridad de las máquinas. Equipo eléctrico de las máquinas. Parte 1: Requisitos generales. Safety of machinery - Electrical equipment of machines - Part 1: General requirements.
UNE EN ISO 13857	Seguridad de máquinas. Distancias de seguridad para impedir que se alcancen zonas peligrosas con los miembros superiores e inferiores. Safety of machinery -- Safety distances to prevent danger zones being reached by upper and lower limbs.
UNE-EN ISO 12499	Ventiladores industriales. Seguridad mecánica de los ventiladores. Protección. Industrial fans -- Mechanical safety of fans -- Guarding.

DIRECTIVAS Y REGLAMENTOS

Directiva 2006/42/CE	Directiva de máquinas. Machinery Directive.
Directiva 2014/35/UE	Directiva de baja tensión. Low Voltage Directive.
Directiva 2014/30/UE	Directiva compatibilidad electromagnética. EMC Directive

Reglamento 305/2011	Condiciones armonizadas para la comercialización de productos de construcción Harmonised conditions for the marketing of construction products
Directiva 2009/125/CE	Directiva de requisitos de diseño ecológico para productos que utilizan energía. Ecodesign Requirements for Energy-related Products Directive.

EJECUCIONES ATEX

Directiva ATEX 2014/34/UE	Aparatos y sistemas de protección para uso en atmósferas potencialmente explosivas. Equipment and protective systems intended for use in potentially explosive atmospheres.
UNE EN 14986	Diseño de ventiladores para trabajar en atmósferas potencialmente explosivas. Design of fans working in potentially explosive atmospheres.
UNE EN 1127-1	Atmósferas explosivas. Prevención y protección contra la explosión. Parte 1: Conceptos básicos y metodología. Explosive atmospheres - Explosion prevention and protection - Part 1: Basic concepts and methodology.

VENTILATION SOLUTIONS



SISTEMAS DE PRESURIZACIÓN PARA ESCALERAS



SISTEMAS DE VENTILACIÓN CON COMPUERTAS



EXTRACCIÓN DE HUMOS PARA PARKINGS



COCINAS PROFESIONALES



SISTEMAS DE VENTILACIÓN PARA VIVIENDAS



VMC RESIDENCIAL COLECTIVA



CORTINAS DE AIRE



EXTRACTORES DE TEJADO



EXTRACTORES ATEX



APLICACIONES INDUSTRIALES



SOLUCIONES HELICOIDALES



Ventiladores centrífugos para aplicaciones industriales **SMALL SERIES**

MEDIA PRESIÓN



18

CMP
Ventiladores centrífugos de media presión equipados con turbina en chapa de acero



26

CMPE
Ventiladores centrífugos de media presión y simple aspiración con motor de rotor exterior



28

CRL
Ventiladores centrífugos de media presión y simple aspiración con turbina a reacción



31

CMR
Ventiladores centrífugos de media presión y de gran robustez



36

CBP
Ventiladores centrífugos de media presión



36

CBPC
Ventiladores centrífugos de media presión con turbina a reacción y salida vertical



38

CMA
Ventiladores centrífugos de media presión y simple aspiración con envoltorio y turbina en fundición de aluminio



42

CPV
Ventiladores centrífugos anticorrosivos de material plástico



ALTA PRESIÓN

TRANSPORTE



47

CA
Ventiladores centrífugos de alta presión y simple aspiración con envolvente y turbina en fundición de aluminio



51

CAS
Ventiladores centrífugos de alta presión en chapa de acero



64

CMTS
Ventiladores centrífugos de media presión, simple aspiración y turbina de pala recta para transporte de humo y sólidos



66

CMT
Ventiladores centrífugos de simple aspiración y turbina de pala recta para transporte de humo y sólidos.



51

CAS-S
Ventiladores centrífugos de alta presión en chapa de acero con atenuador acústico



60

CAM
Ventiladores centrífugos de alta presión con turbina en fundición de aluminio



69

CMAT
Ventiladores centrífugos de media presión para transporte de sólidos



72

PORT
Extractores de aire portátiles de gran potencia y robustez

CMP



Ventiladores centrífugos de media presión y simple aspiración con envoltorio y turbina en chapa de acero



Ventilador:

- Envoltorio en chapa de acero.
- Turbina a acción en chapa de acero galvanizado.
- Modelo CMP 38-2M envoltorio en fundición de aluminio.
- Temperatura máxima del aire a transportar: -20 °C +120 °C, máximo +100 °C modelo CMP-38.

Motor:

- Motores con eficiencia IE3 para potencias iguales o superiores a 0,75 kW, excepto monofásicos, 2 velocidades y 8 polos.
- Motores clase F con rodamientos a bolas y protección IP55. Excepto modelos monofásicos con protección IP54. Modelo CMP-38 con protección IP21.
- Monofásico 230 V 50 Hz y trifásico 230/400 V 50 Hz (hasta 4 kW) y 400/690 V 50 Hz (potencias superiores a 4 kW).

Acabado:

- Anticorrosivo en resina de poliéster polimerizada a 190 °C, previo desengrase con tratamiento nanotecnológico libre de fosfatos.

Bajo demanda:

- Bobinados especiales para diferentes tensiones.
- Ventilador preparado para transportar aire hasta +250 °C.
- Ventilador en acero inoxidable.
- Certificación ATEX Categoría 2 (ver serie CMP/ATEX).



Podetes equilibrados dinámicamente con núcleos de gran robustez

Código de pedido



CMP: Ventiladores centrífugos de media presión y simple aspiración con envoltorio y turbina en chapa de acero

Tamaño turbina

Número de polos motor
2=2900 r/min 50 Hz
4=1400 r/min 50 Hz
6=900 r/min 50 Hz

T=Trifásico
M=Monofásico

Potencia motor (CV)

Características técnicas

Modelo	Velocidad (r/min)	Intensidad máxima admisible (A)			Potencia instalada (kW)	Caudal máximo (m3/h)	Nivel presión sonora (dB (A))	Peso aprox. (Kg)	According ErP
		230V	400V	690V					
CMP-38-2M/E	2650	0,50			0,01	135	50	2	Excluded
CMP-38-2M	2600	0,50			0,01	160	50	2	Excluded
CMP-512-2T	2670	0,64	0,37		0,09	380	62	4	Excluded
CMP-512-2M	2760	0,79			0,09	380	62	4	Excluded
CMP-512-4T	1320	0,65	0,38		0,09	255	55	4	Excluded
CMP-512-4M	1370	0,83			0,09	255	55	4	Excluded
CMP-514-2T	2750	1,21	0,70		0,18	700	65	5	2015
CMP-514-2M	2780	1,42			0,18	700	65	5	2015
CMP-514-4T	1320	0,65	0,38		0,09	565	58	5	Excluded
CMP-514-4M	1370	0,83			0,09	565	58	5	Excluded
CMP-616-2T	2760	2,57	1,49		0,55	1380	69	8	2015
CMP-616-2M	2810	3,49			0,55	1380	69	10	2015
CMP-616-4T	1320	0,65	0,38		0,09	850	61	8	Excluded
CMP-616-4M	1370	0,83			0,09	850	61	8	Excluded
CMP-620-2T	2710	1,92	1,11		0,37	765	68	10	2015
CMP-620-2M	2780	2,53			0,37	765	68	10	2015
CMP-620-4T	1320	0,96	0,56		0,12	810	61	8	Excluded

Características técnicas

Modelo	Velocidad (r/min)	Intensidad máxima admisible (A)			Potencia instalada (kW)	Caudal máximo m3/h	Nivel presión sonora dB (A)	Peso aprox. (Kg)	According ErP
		230V	400V	690V					
CMP-620-4M	1380	1,03			0,12	810	61	8	Excluded
CMP-718-2T IE3	2825	2,80	1,62		0,75	1485	70	18	2015
CMP-718-2M	2810	4,50			0,75	1485	70	13	2015
CMP-718-4T	1350	1,66	0,96		0,25	1280	63	10	2015
CMP-718-4M	1370	2,00			0,25	1280	63	10	2015
CMP-820-2T IE3	2830	4,03	2,34		1,10	1950	73	16	2015
CMP-820-2M	2820	6,51			1,10	1950	73	16	2015
CMP-820-4T	1350	1,66	0,96		0,25	1670	66	10	2015
CMP-820-4M	1370	2,00			0,25	1670	66	10	2015
CMP-922-2T-1.5 IE3	2830	4,03	2,34		1,10	1650	70	21	2015
CMP-922-2T-2 IE3	2875	5,34	3,07		1,50	2010	71	27	2015
CMP-922-2T-3 IE3	2910	7,32	4,21		2,20	2600	74	30	2015
CMP-922-4T	1380	2,92	1,69		0,55	2450	66	19	2015
CMP-1025-2T-3 IE3	2910	7,32	4,21		2,20	2100	73	33	2015
CMP-1025-2T-4 IE3	2910	10,00	5,77		3,00	2830	77	41	2015
CMP-1025-4T IE3	1455	4,07	2,34		1,10	3400	70	43	2015
CMP-1128-2T-4 IE3	2910	10,00	5,77		3,00	2220	77	45	2015
CMP-1128-2T-5.5 IE3	2900	13,00	7,50		4,00	3210	81	56	2015
CMP-1128-4T IE3	1435	7,93	4,56		2,20	5000	74	40	2015
CMP-1128-6T IE3	940	3,36	1,93		0,75	3300	60	32	2015
CMP-1231-4T-3 IE3	1435	7,93	4,56		2,20	4740	73	48	2015
CMP-1231-4T-4 IE3	1440	10,70	6,15		3,00	5910	75	54	2015
CMP-1231-4T-5.5 IE3	1450	13,90	8,00		4,00	6850	77	58	2015
CMP-1231-6T IE3	950	6,43	3,70		1,50	5115	64	53	2015
CMP-1435-4T-4 IE3	1440	10,70	6,15		3,00	5560	76	58	2015
CMP-1435-4T-5.5 IE3	1450	13,90	8,00		4,00	6260	78	64	2015
CMP-1435-4T-7.5 IE3	1465		10,30	5,97	5,50	7210	80	99	2015
CMP-1640-4T-5.5 IE3	1450	13,90	8,00		4,00	7000	77	81	2015
CMP-1640-4T-7.5 IE3	1465		10,30	5,97	5,50	8035	80	116	2015
CMP-1640-4T-10 IE3	1465		13,90	8,06	7,50	9710	82	120	2015
CMP-1640-6T IE3	950	9,08	5,22		2,20	8100	71	80	2015
CMP-1845-4T-7.5 IE3	1465		10,30	5,97	5,50	8000	82	117	2015
CMP-1845-4T-10 IE3	1465		13,90	8,06	7,50	10000	85	121	2015
CMP-1845-6T IE3	950	9,08	5,22		2,20	7500	77	88	2015
CMP-2050-4T-10 IE3	1465		13,90	8,06	7,50	9000	83	150	2015
CMP-2050-4T-15 IE3	1470		20,90	12,10	11,00	12525	87	178	2015
CMP-2050-4T-20 IE3	1465		27,90	16,20	15,00	16500	89	189	2015
CMP-2050-6T IE3	960	15,60	8,99		4,00	11000	79	144	2015



Erp. (Energy Related Products)

Información de la Directiva 2009/125/EC descargable desde la web de SODECA o programa de selección QuickFan

Características acústicas

Espectro de potencia sonora Lw(A) en dB(A) por banda de frecuencia en Hz

Modelo	63	125	250	500	1000	2000	4000	8000	Modelo	63	125	250	500	1000	2000	4000	8000
38	25	35	46	53	57	54	52	45	1128-2-5,5	56	66	77	84	88	85	83	76
512-2	37	47	58	65	69	66	64	57	1128-4	49	59	70	77	81	78	76	69
512-4	30	40	51	58	62	59	57	50	1128-6	35	45	56	63	67	64	62	55
514-2	40	50	61	68	72	69	67	60	1231-4-3	51	60	71	78	82	80	78	71
514-4	33	43	54	61	65	62	60	53	1231-4-4	53	62	73	80	84	82	80	73
616-2	44	54	65	72	76	73	71	64	1231-4-5,5	55	64	75	82	86	84	82	75
616-4	36	46	57	64	68	65	63	56	1231-6	42	51	62	69	73	71	69	62
620-2	43	53	64	71	75	72	70	63	1435-4-4	54	63	74	81	85	83	81	74
620-4	36	46	57	64	68	65	63	56	1435-4-5,5	56	65	76	83	87	85	83	76
718-2	45	55	66	73	77	74	72	65	1435-4-7,5	58	67	78	85	89	87	85	78
718-4	38	48	59	66	70	67	65	58	1640-4-5,5	55	64	75	82	86	84	82	75
820-2	48	58	69	76	80	77	75	68	1640-4-7,5	58	67	78	85	89	87	85	78
820-4	41	51	62	69	73	70	68	61	1640-4-10	60	69	80	87	91	89	87	80
922-2-1,5	45	55	66	73	77	74	72	65	1640-6	49	58	69	76	80	78	76	69
922-2-2	46	56	67	74	78	75	73	66	1845-4-7,5	61	71	82	89	93	91	89	81
922-2-3	49	59	70	77	81	78	76	69	1845-4-10	64	74	85	92	96	94	92	84
922-4	41	51	62	69	73	70	68	61	1845-6	56	66	77	84	88	86	84	76
1025-2-3	48	58	69	76	80	77	75	68	2050-4-10	62	72	83	90	94	92	90	82
1025-2-4	52	62	73	80	84	81	79	72	2050-4-15	66	76	87	94	98	96	94	86
1025-4	45	55	66	73	77	74	72	65	2050-4-20	68	78	89	96	100	98	96	88
1128-2-4	52	62	73	80	84	81	79	72	2050-6	58	68	79	86	90	88	86	78

Dimensiones mm

CMP-38

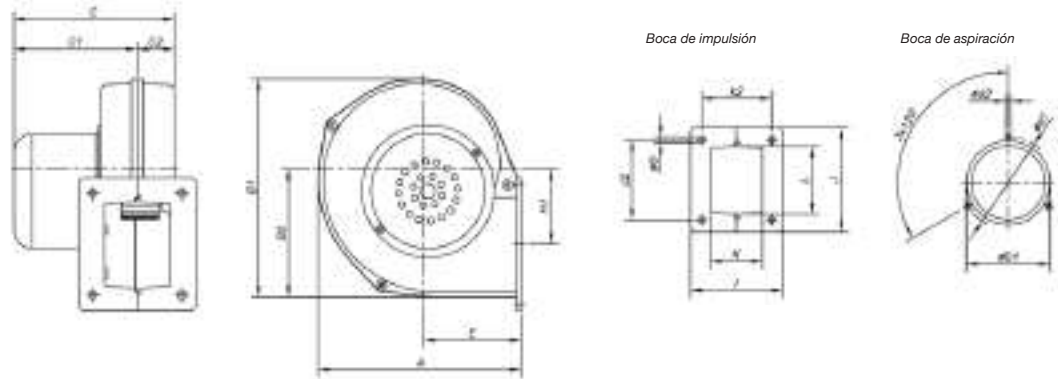

	A	B1	B2	C	C1	C2	øD1*	ød1	ød2	E	H1	I	J	J2	K	k2	L	øO
CMP-38-2M/E	141	165	97	122	96	26	80	85	2,4	60	60,5	100	80	46	50	77	52	8
CMP-38-2M	164,5	176,5	103,5	130	100	30	60	85	M4	79	61	95	107	82	53	72	69	6,5

* Diámetro nominal tubería recomendada

CMP-512...820

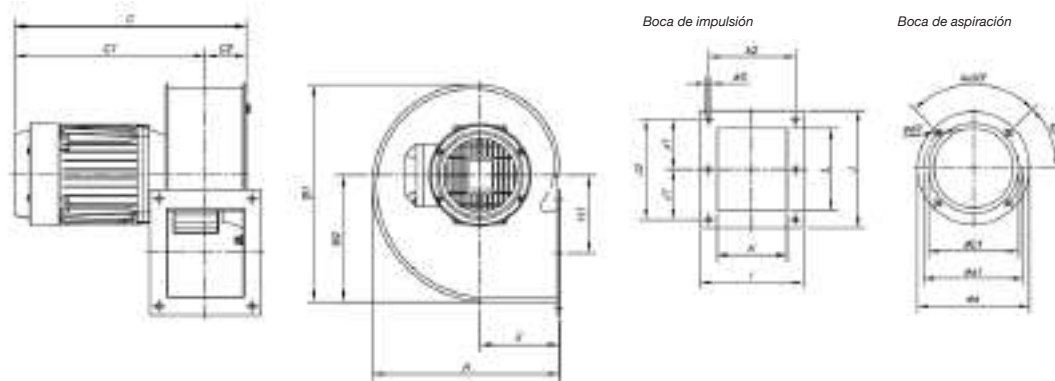

	A	B1	B2	C	C1	C2	øD1*	ød	ød1	ød2	E	H1	I	J	J1	J2	K	k2	L	øO
CMP-512-2T	185	206,5	118	251	212	39	112	140	132	M4	81	69	106	118	-	104,5	75	93	86	5,5
CMP-512-4T	185	206,5	118	249	210	39	112	140	132	M4	81	69	106	118	-	104,5	75	93	86	5,5
CMP-514-2T	225	254	150	281	236	45	140	169	151,5	M4	100	91	122	147	64	128	83	105	107	6,5
CMP-514-4T	225	254	150	261	216	45	140	169	151,5	M4	100	91	122	147	64	128	83	105	107	6,5
CMP-616-2T	258	297	173,5	320	264	56	160	204	180	M6	110	105,5	153	172	-	147	103	128	122	7
CMP-616-4T	258	297	173,5	283	227	56	160	204	180	M6	110	105,5	153	172	-	147	103	128	122	7
CMP-620-2T	298	347	202,5	321	265	56	200	247	230	M6	126	145,5	159	153	-	128	105	134	100	8
CMP-620-4T	298	347	202,5	283	227	56	200	247	230	M6	126	145,5	159	153	-	128	105	134	100	8
CMP-718-2T	303,5	348	201	355	294	61	180	238	210	M6	129,5	122	169	192	85	170	115	145	146	9
CMP-718-2M	303,5	348	201	355	245	61	180	238	210	M6	129,5	122	169	192	85	170	115	145	146	9
CMP-718-4T	303,5	348	201	331	270	61	180	238	210	M6	129,5	122	169	192	85	170	115	145	146	9
CMP-718-4M	303,5	348	201	331	270	61	180	238	210	M6	129,5	122	169	192	85	170	115	145	146	9
CMP-820-2T	322	377	223	369,5	301	68,5	200	247	230	M6	137,5	137	184	213	94,5	189	130	160	156	9
CMP-820-2M	322	377	223	369,5	301	68,5	200	247	230	M6	137,5	137	184	213	94,5	189	130	160	156	9
CMP-820-4T	322	377	223	345,5	277	68,5	200	247	230	M6	137,5	137	184	213	94,5	189	130	160	156	9
CMP-820-4M	322	377	223	345,5	277	68,5	200	247	230	M6	137,5	137	184	213	94,5	189	130	160	156	9

* Diámetro nominal tubería recomendada

SMALL SERIES

Dimensiones mm

CMP-922...1231

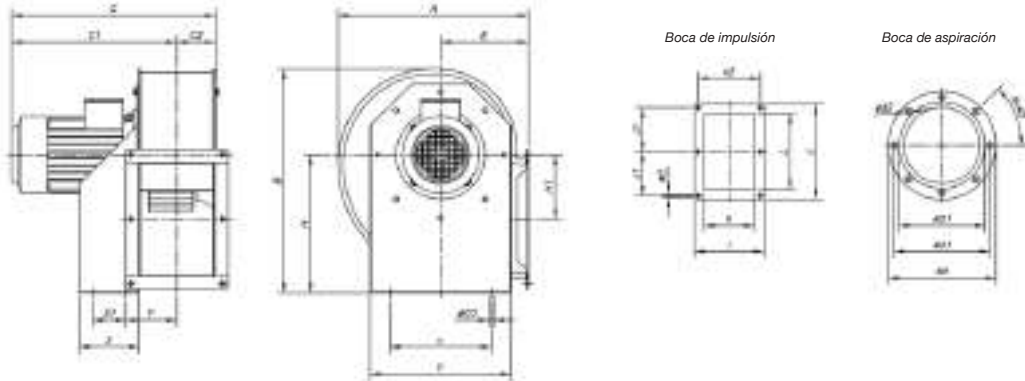

	A	B	C	C1	C2	øD1*	ød	ød1	ød2	E	H	H1	I	J	J1	K	k2	L	øO	øO1	V	v	X	X1	Y
CMP-922-2T-1'5	388,5	455	382,5	309	73,5	224	278	256	M8	180	280	134	204	282,5	128	140	180	215	9,5	10,5	290	220	114	50	105
CMP-922-2T-2	388,5	455	430,5	357	73,5	224	278	256	M8	180	280	134	204	282,5	128	140	180	215	9,5	10,5	290	220	114	50	105
CMP-922-2T-3	388,5	455	430,5	357	73,5	224	278	256	M8	180	280	134	204	282,5	128	140	180	215	9,5	10,5	290	220	114	50	105
CMP-922-4T	388,5	455	382,5	309	73,5	224	278	256	M8	180	280	134	204	282,5	128	140	180	215	9,5	10,5	290	220	114	50	105
CMP-1025-2T-3	427	503	456	370	86	250	305	282	M8	197	310	144	229	312,5	145	165	205	250	9,5	12,5	315	228	134	74	115,5
CMP-1025-2T-4	427	503	486	400	86	250	305	282	M8	197	310	144	229	312,5	145	165	205	250	9,5	12,5	315	228	134	74	115,5
CMP-1025-4T	427	503	456	370	86	250	305	282	M8	197	310	144	229	312,5	145	165	205	250	9,5	12,5	315	228	134	74	115,5
CMP-1128-2T-4	472	553	500,5	407	93,5	280	348	320	M8	216	340	152	244	364	170	180	220	296,5	9,5	12,5	348	245	144	95	122,5
CMP-1128-2T-5'5	472	553	523,5	430	93,5	280	348	320	M8	216	340	152	244	364	170	180	220	296,5	9,5	12,5	348	245	144	95	122,5
CMP-1128-4T	472	553	500,5	407	93,5	280	348	320	M8	216	340	152	244	364	170	180	220	296,5	9,5	12,5	348	245	144	95	122,5
CMP-1128-6T	472	553	470,5	377	93,5	280	348	320	M8	216	340	152	244	364	170	180	220	296,5	9,5	12,5	348	245	144	95	122,5
CMP-1231-4T-3	526	630	520,5	417	103,5	315	382	354	M8	238	390	179,5	264	382,5	180	200	240	320	11,5	13	382	322	183	140	126
CMP-1231-4T-4	526	630	520,5	417	103,5	315	382	354	M8	238	390	179,5	264	382,5	180	200	240	320	11,5	13	382	322	183	140	126
CMP-1231-4T-5'5	526	630	543,5	440	103,5	315	382	354	M8	238	390	179,5	264	382,5	180	200	240	320	11,5	13	382	322	183	140	126
CMP-1231-6T	526	630	520,5	417	103,5	315	382	354	M8	238	390	179,5	264	382,5	180	200	240	320	11,5	13	382	322	183	140	126

* Diámetro nominal tubería recomendada

CMP-1435...2563

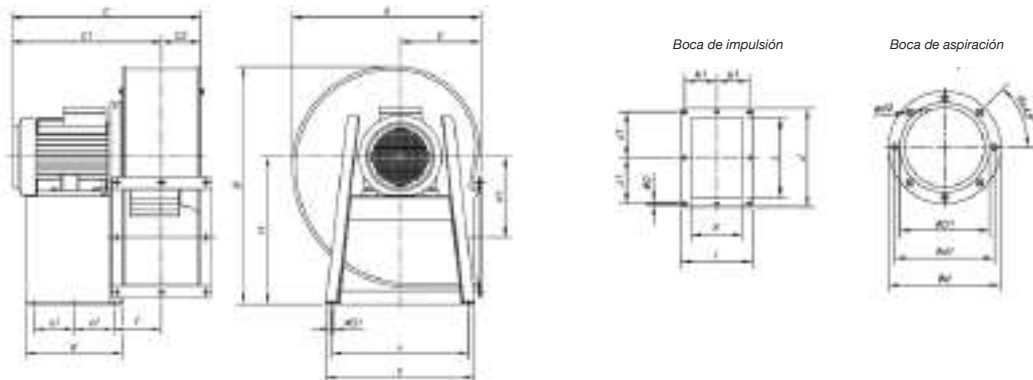

	A	B	C	C1	C2	øD1*	ød	ød1	ød2	E	H	H1	I	J	J1	K	k1	L	øO	øO1	V	v	X	X1	Y
CMP-1435-4T-4	573,5	715	549	431	118	355	422	394	M8	250	445	242,5	292	342,5	159	228	133	280	11,5	12	456	420	333	136,5	150
CMP-1435-4T-5'5	573,5	715	572	454	118	355	422	394	M8	250	445	242,5	292	342,5	159	228	133	280	11,5	12	456	420	333	136,5	150
CMP-1435-4T-7'5	573,5	715	610	492	118	355	422	394	M8	250	445	242,5	292	342,5	159	228	133	280	11,5	12	456	420	333	136,5	150
CMP-1640-4T-5'5	634	799	596	465	130	400	464	438	M8	270	495	271	336	404	185	250	150	321	11,5	12	500	460	327	133,5	162,5
CMP-1640-4T-7'5	634	799	634	504	130	400	464	438	M8	270	495	271	336	404	185	250	150	321	11,5	12	500	460	327	133,5	162,5
CMP-1640-4T-10	634	799	634	504	130	400	464	438	M8	270	495	271	336	404	185	250	150	321	11,5	12	500	460	327	133,5	162,5
CMP-1640-6T	634	799	596	466	130	400	464	438	M8	270	495	271	336	404	185	250	150	321	11,5	12	500	460	327	133,5	162,5
CMP-1845-4T-7'5	711	901	668	521	147	450	515	485	M8	302	560	305	370	444	202	284	164	361	11,5	12	538	502	340	140	179,5
CMP-1845-4T-10	711	901	668	521	147	450	515	485	M8	302	560	305	370	444	202	284	164	361	11,5	12	538	502	340	140	179,5
CMP-1845-6T	711	901	630	483	147	450	515	485	M8	302	560	305	370	444	202	284	164	361	11,5	12	538	502	340	140	179,5
CMP-2050-4T-10	797	987	700,5	538	162,5	500	565	535	M10	345	610	313	411	544	250	315	182,5	451	11,5	12	653	615	435	188	196
CMP-2050-4T-15	797	987	805,5	643	162,5	500	565	535	M10	345	610	313	411	544	250	315	182,5	451	11,5	12	653	615	435	188	196
CMP-2050-4T-20	797	987	805,5	643	162,5	500	565	535	M10	345	610	313	411	544	250	315	182,5	451	11,5	12	653	615	435	188	196
CMP-2050-6T	797	987	700,5	538	162,5	500	565	535	M10	345	610	313	411	544	250	315	182,5	451	11,5	12	653	615	435	188	196

* Diámetro nominal tubería recomendada

Curvas características

Q= Caudal en m³/h, m³/s y cfm

Pe= Presión estática en mmH₂O, Pa e inwg

2T/2M=3000 r/min

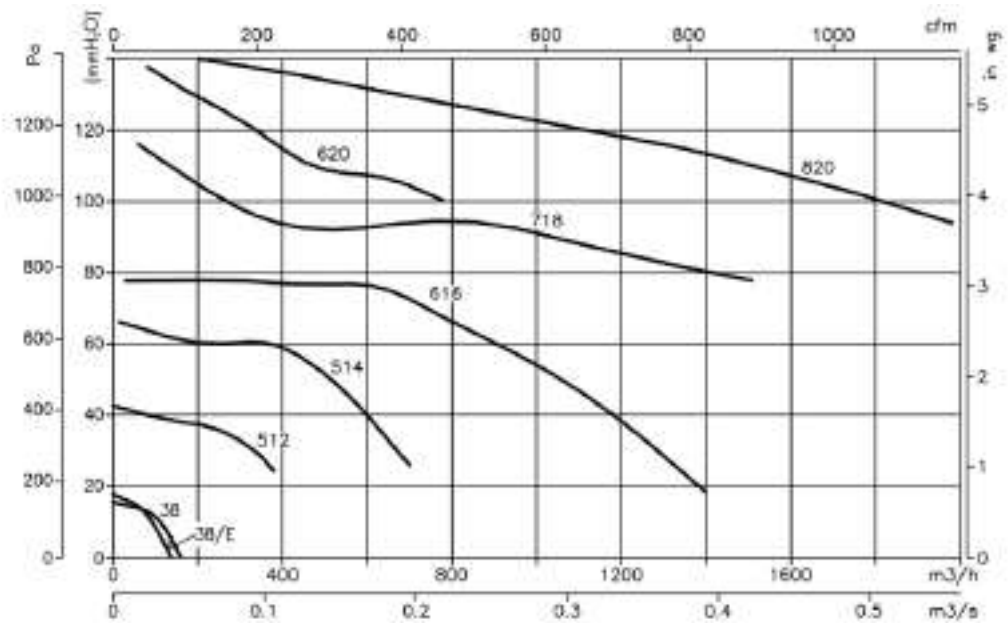

4T/4M=1500 r/min

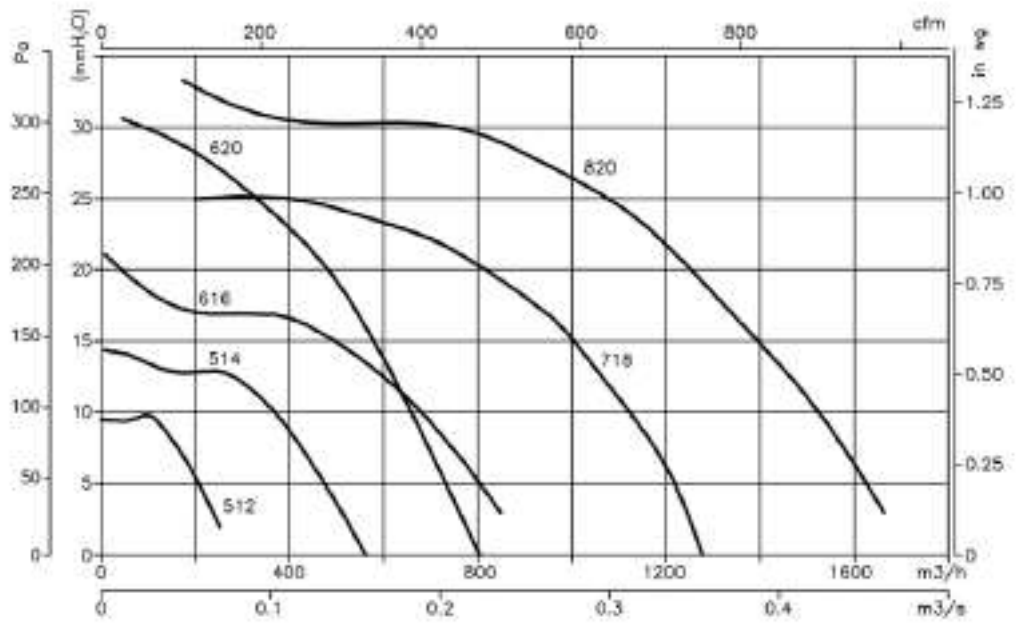

SMALL SERIES

Curvas características

Q= Caudal en m³/h, m³/s y cfm

Pe= Presión estática en mmH₂O, Pa e inwg

2T=3000 r/min

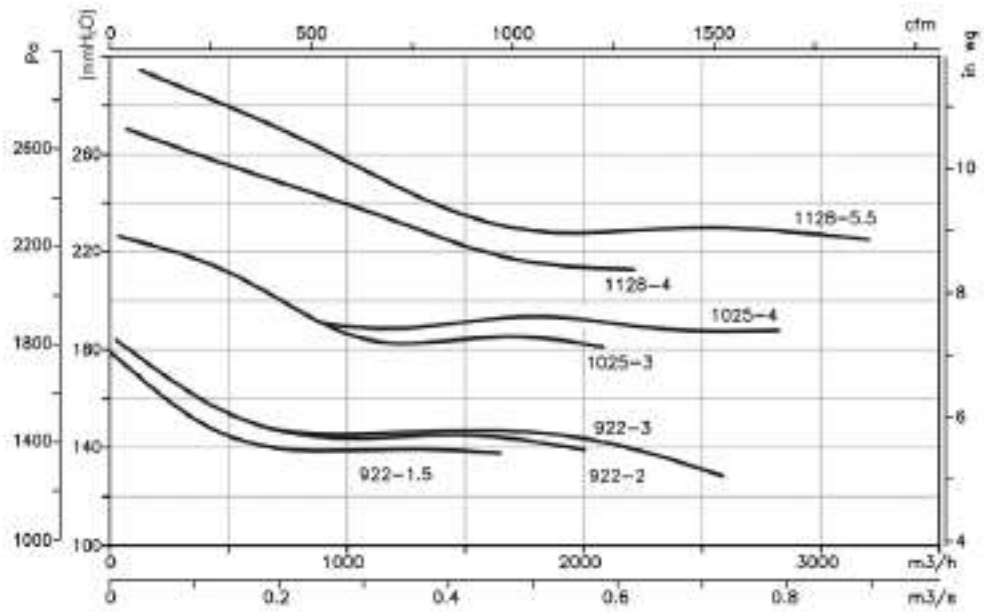

4T=1500 r/min
6T=1000 r/min

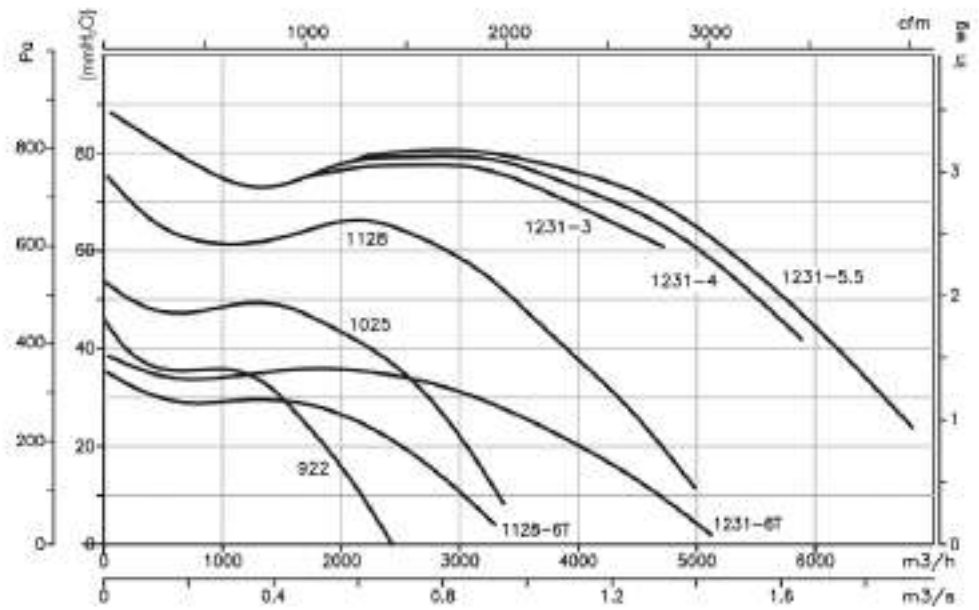

Curvas características

Q= Caudal en m³/h, m³/s y cfm

Pe= Presión estática en mmH₂O, Pa e inwg

4T=1500 r/min

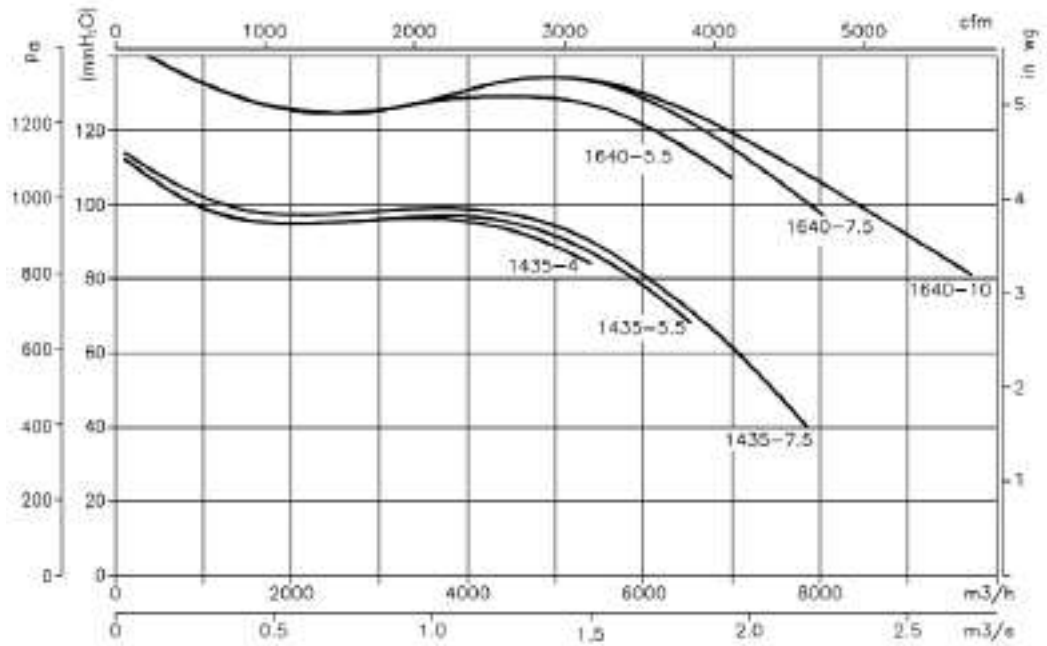

4T=1500 r/min

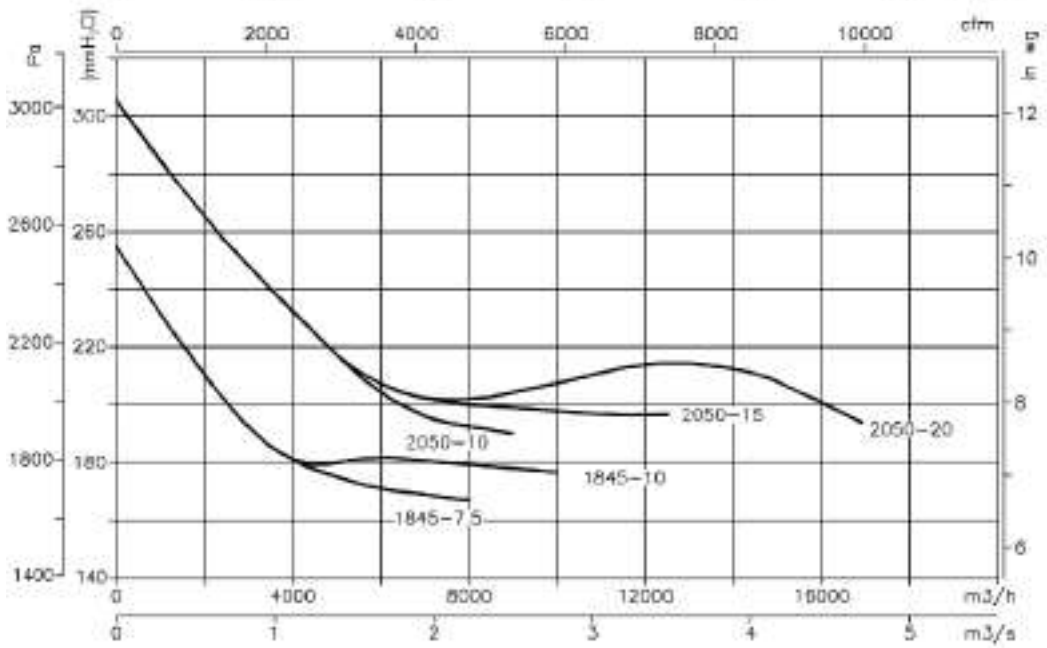

SMALL SERIES

Curvas características

Q= Caudal en m³/h, m³/s y cfm

Pe= Presión estática en mmH₂O, Pa e inwg

6T=1000 r/min

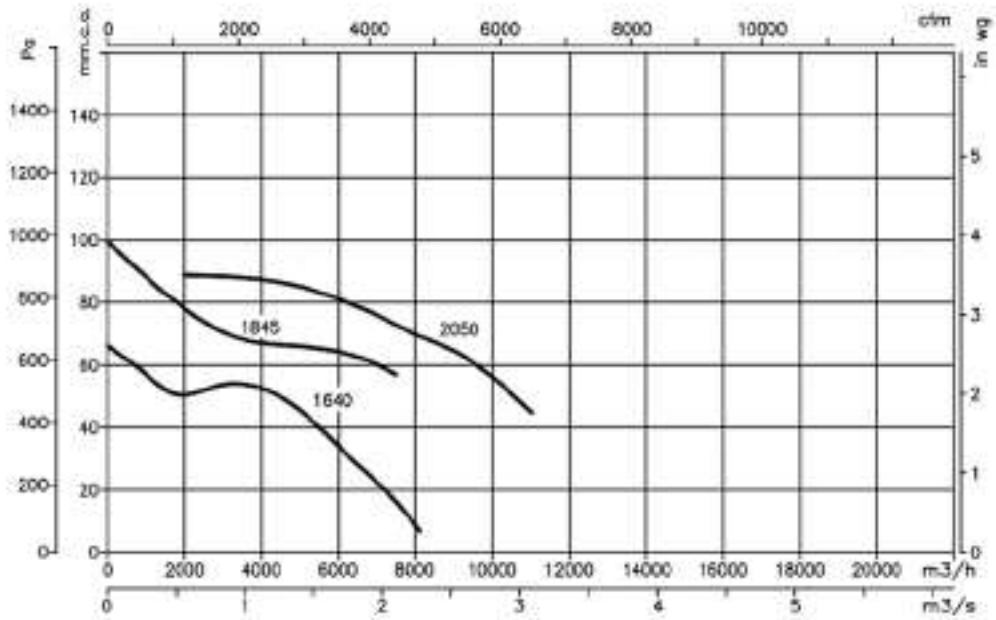

Orientaciones

Suministro standard LG 270

Posiciones LG 180 y RD 180 bajo demanda y con medidas de anclaje especiales.



Accesorios



CMPE



Ventiladores centrífugos de media presión y simple aspiración con motor de rotor exterior



Ventilador:

- Envoltente en chapa de acero.
- Turbina a acción.
- Caja de bornes externa con entrada de cable con prensaestopas.

Acabado:

- Anticorrosivo en resina de poliéster polimerizada a 190 °C, previo desengrase con tratamiento nanotecnológico libre de fosfatos.

Motor:

- Motores clase F de rotor exterior, con rodamientos a bolas.
- Monofásico 230 V 50/60 Hz.
- Temperatura máxima del aire a transportar: -20 °C +60 °C.

Código de pedido

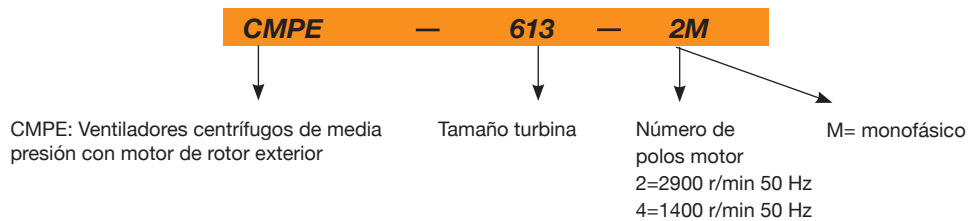

Características técnicas

Modelo	Velocidad	Intensidad máxima admisible (A)	Potencia eléctrica máx.	Caudal máximo	Nivel presión sonora	Peso aprox.	According ErP
	(r/min)	230V	(kW)	m3/h	dB (A)	(Kg)	
CMPE-613-2M	1800	0,45	0,105	295	59	2,6	Excluded
CMPE-614-2M	2230	0,75	0,177	510	65	3,0	Excluded
CMPE-716-4M	1430	0,32	0,060	440	59	3,6	Excluded
CMPE-918-4M	1360	0,75	0,155	960	67	5,5	Excluded



Erp. (Energy Related Products)

Información de la Directiva 2009/125/EC descargable desde la web de SODECA o programa de selección QuickFan

SMALL SERIES

Dimensiones mm

CMPE-613-2M

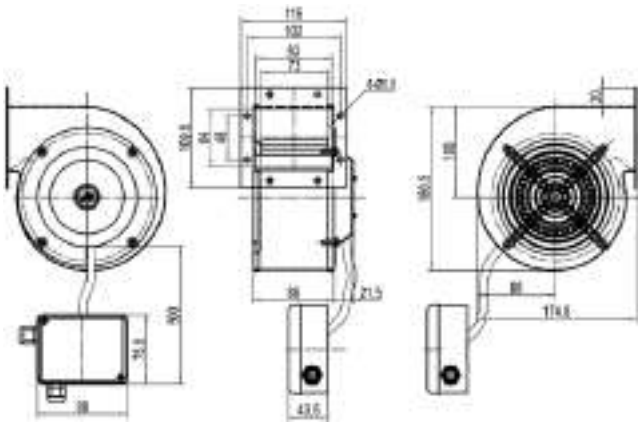

CMPE-614-2M

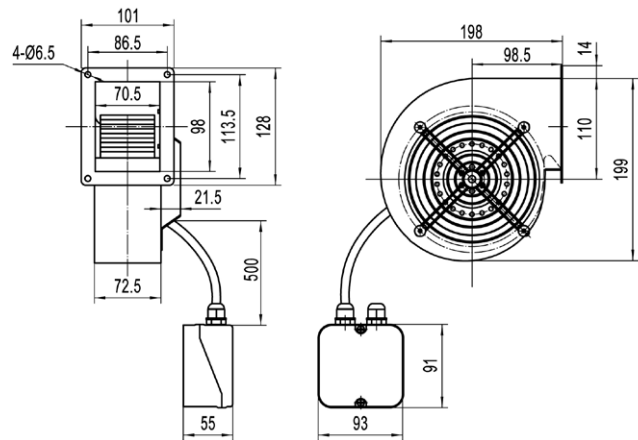

CMPE-716-4M

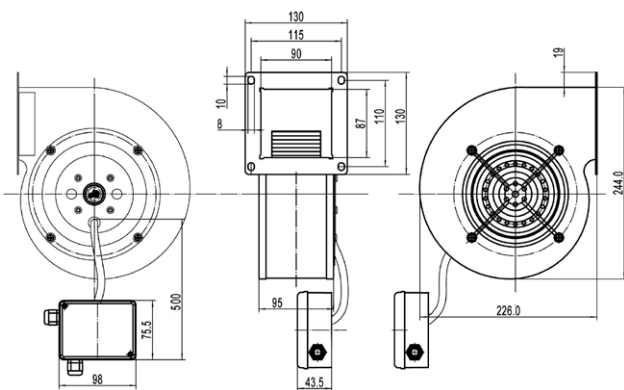

CMPE-918-4M

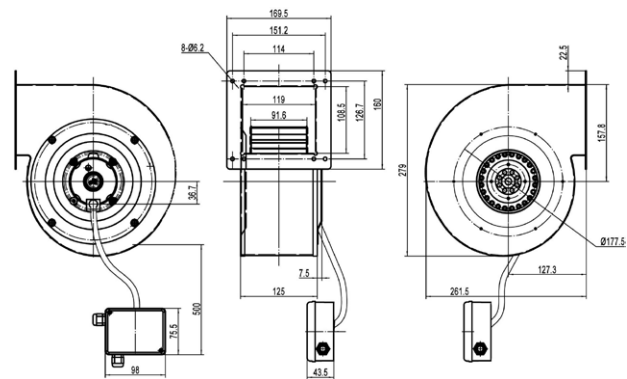

Curvas Características

Q= Caudal en m³/h, m³/s y cfm

Pe= Presión estática en mmH₂O, Pa e inwg

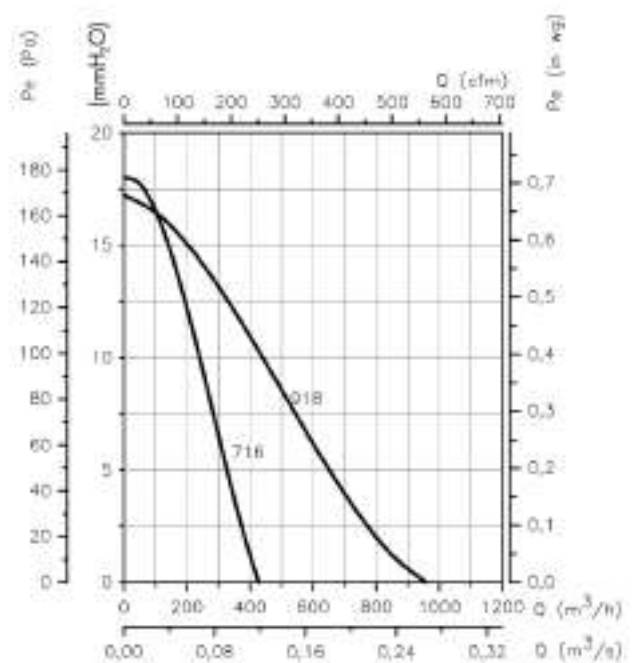
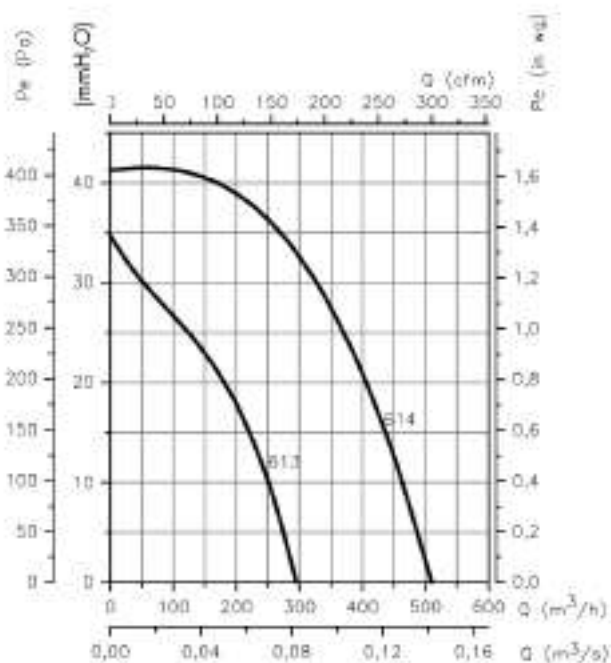

CRL



Ventiladores centrífugos de media presión y simple aspiración con turbina a reacción



Ventilador:

- Envoltente en chapa de acero.
- Turbina a reacción en chapa de acero.
- Temperatura máxima del aire a transportar: -20 °C +120 °C.

Acabado:

- Anticorrosivo en resina de poliéster polimerizada a 190 °C, previo desengrase con tratamiento nanotecnológico libre de fosfatos.

Motor:

- Motores con eficiencia IE3 para potencias iguales o superiores a 0,75 kW, excepto monofásicos, 2 velocidades y 8 polos.
- Motores clase F con rodamientos a bolas. Protección IP55.
- Trifásicos 230/400 V 50 Hz.

Bajo demanda:

- Modelos a 60 Hz.
- Bobinados especiales para diferentes tensiones.
- Ventilador preparado para transportar aire hasta +250 °C.
- Ventilador en acero inoxidable.

Código de pedido

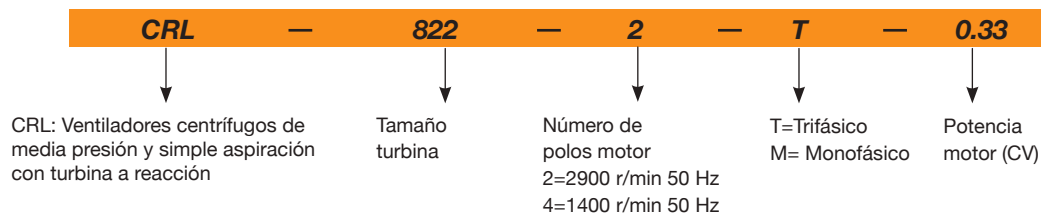

Características técnicas

Modelo	Velocidad (r/min)	Intensidad máxima admisible (A)		Potencia instalada (kW)	Caudal máximo (m³/h)	Nivel presión sonora dB(A)	Peso aprox. (Kg)	According ErP
		230V	400V					
CRL-822-2T-0.33	2760	1,24	0,71	0,25	1350	72	19	2015
CRL-925-2T-0.5	2830	1,56	0,90	0,37	1850	75	22	2015
CRL-1028-2T-0.75	2780	2,17	1,25	0,55	2600	77	29	2015
CRL-1031-2T-1.5 IE3	2830	4,03	2,32	1,10	3600	82	41	2015
CRL-1135-2T-3 IE3	2870	7,70	4,43	2,20	5230	71	59	2015
CRL-1240-2T-4 IE3	2910	10,00	5,77	3,00	7320	90	85	2015
CRL-1240-4T-1 IE3	1420	2,82	1,62	0,75	3630	74	66	2015
CRL-1445-4T-1.5 IE3	1455	4,07	2,34	1,10	6170	78	83	2015
CRL-1650-4T-2 IE3	1450	5,48	3,15	1,50	8500	81	106	2015
CRL-1856-4T-3 IE3	1435	7,93	4,56	2,20	12080	84	132	2015

Características acústicas

Espectro de potencia sonora Lw(A) en dB(A) banda de frecuencia en [Hz]

Modelo	63	125	250	500	1000	2000	4000	8000	Modelo	63	125	250	500	1000	2000	4000	8000
CRL-822-2T-0.33	54	67	67	80	75	75	75	68	CRL-1240-2T-4 IE3	69	84	82	94	91	95	97	84
CRL-925-2T-0.5	58	71	71	84	79	79	79	72	CRL-1240-4T-1 IE3	57	71	77	80	80	81	71	60
CRL-1028-2T-0.75	59	72	72	85	80	80	80	73	CRL-1445-4T-1.5 IE3	60	73	79	84	81	84	79	65
CRL-1031-2T-1.5 IE3	65	78	78	91	86	86	86	79	CRL-1650-4T-2 IE3	67	77	85	87	86	88	79	69
CRL-1135-2T-3 IE3	57	64	62	74	72	78	77	64	CRL-1856-4T-3 IE3	68	77	90	86	89	90	84	70

Dimensiones mm

CRL-822-1028

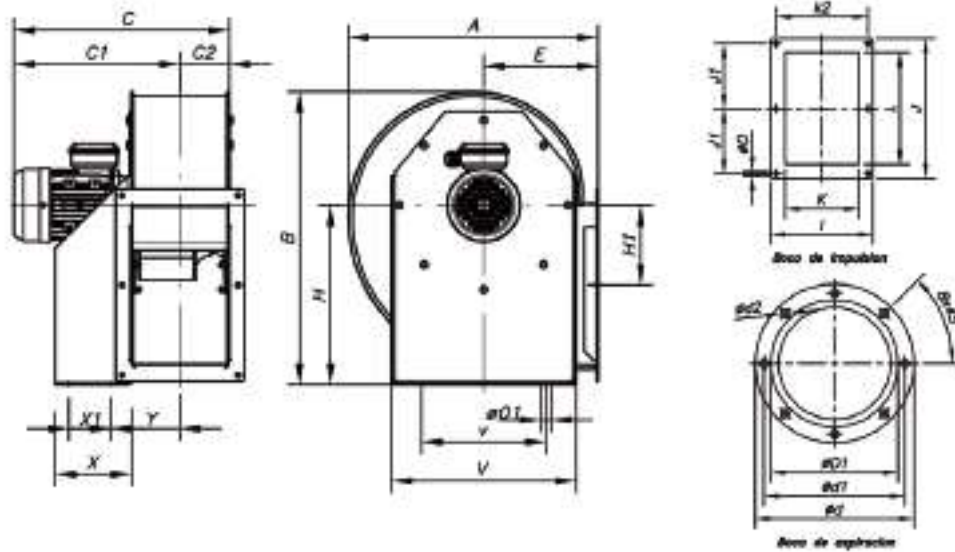

	A	B	C	C1	C2	ØD1*	ød	Ød1	Ød2	E	H	H1	I	J	J1	K	K2	L	Ø0	Ø01	V	v	X	X1	Y
CRL-822-2T	388	455	342,5	270	71,5	224	278	256	M8	180	280	134	204	282,5	128	140	180	215	9,5	10,5	290	220	114	50	105
CRL-925-2T	427	500	390	306	85	250	305	282	M8	197	310	145	229	312,5	145	165	205	250	9,5	12,5	315	228	134	74	115
CRL-1028-2T	472	550	407	315	93	280	348	320	M8	215	340	152	244	364	170	180	220	296,5	9,5	12,5	350	245	144	95	120

*Diámetro nominal tubería recomendada

CRL-1031-1856

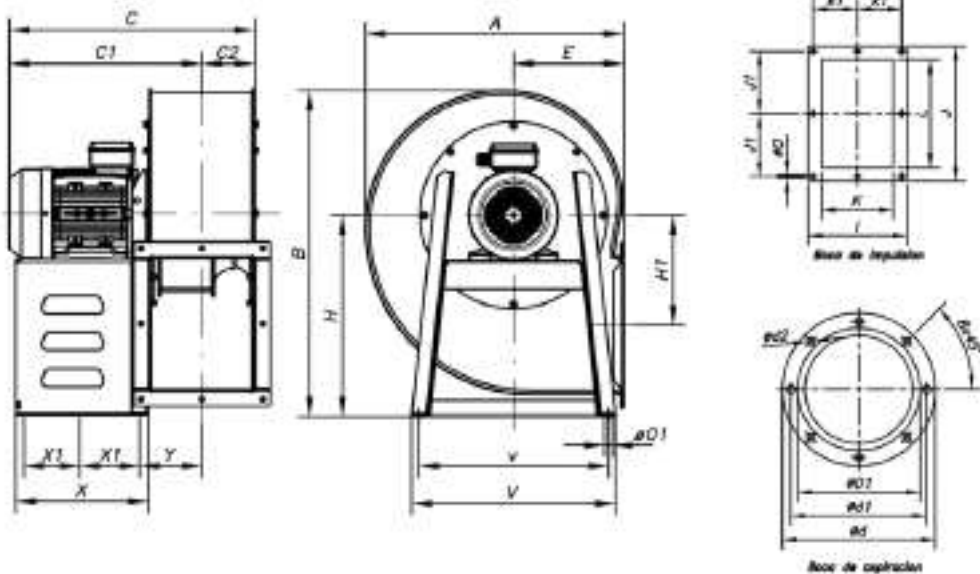

	A	B	C	C1	C2	ØD1*	ød	Ød1	Ød2	E	H	H1	I	J	J1	K	K1	K2	L	Ø0	Ø01	V	v	X	X1	Y
CRL-1031-2T	526	630	445	340	103,5	315	382	354	M8	238	390	180	264	382,5	180	200	-	240	320	11,5	12	430	400	200	155	130
CRL-1135-2T	573,5	715	500	382,5	118	355	422	394	M8	250	450	242,5	292	342,5	159	228	133	-	280	11,5	12	485	455	245	195	145
CRL-1240-2T	635	800	585	455	130	400	464	438	M8	270	495	270	336	404	185	250	150	-	321	11,5	12	500	460	300	133,5	125
CRL-1240-4T	635	800	500	368,5	130	400	464	438	M8	270	495	270	336	404	185	250	150	-	321	11,5	12	500	460	250	200	157
CRL-1445-4T	710	900	600	412	147	450	515	485	M8	300	560	305	370	444	202	284	164	-	361	11,5	12	575	550	275	215	180
CRL-1650-4T	797	990	590	427	162,5	500	565	535	M8	345	615	313	411	544	250	315	182,5	-	451	11,5	12	640	615	275	215	195
CRL-1856-4T	900	1100	510	505	182	560	625	610	M8	395	680	325	457	660	203	355	203,5	-	560	13	12	580	550	300	240	215

*Diámetro nominal tubería recomendada



Erp. (Energy Related Products)

Información de la Directiva 2009/125/EC descargable desde la web de SODECA o programa de selección QuickFan

Curvas características

Q= Caudal en m³/h, m³/s y cfm.

Pe= Presión estática en mmH₂O, Pa e inwg.

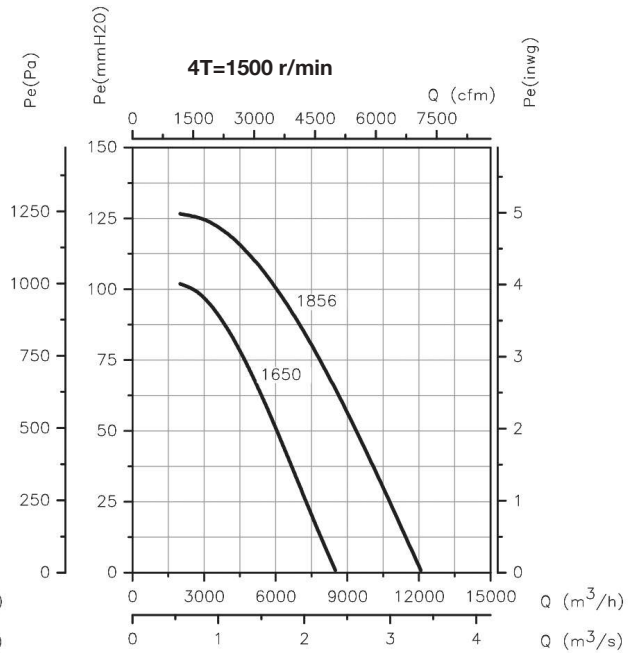
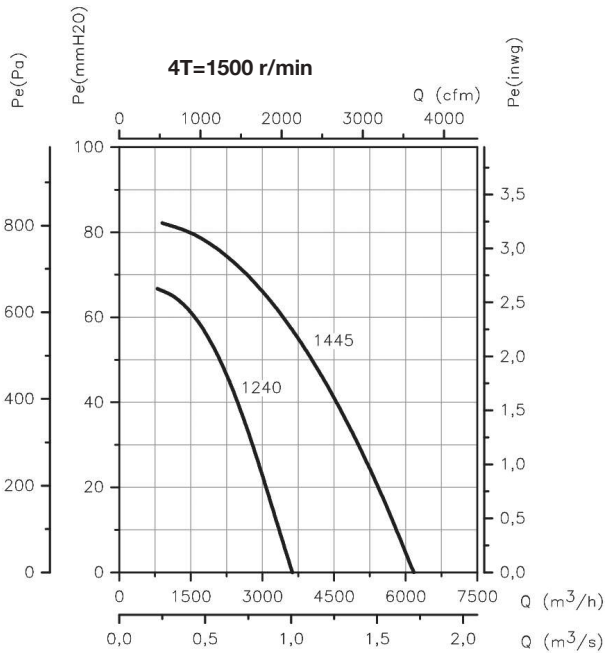
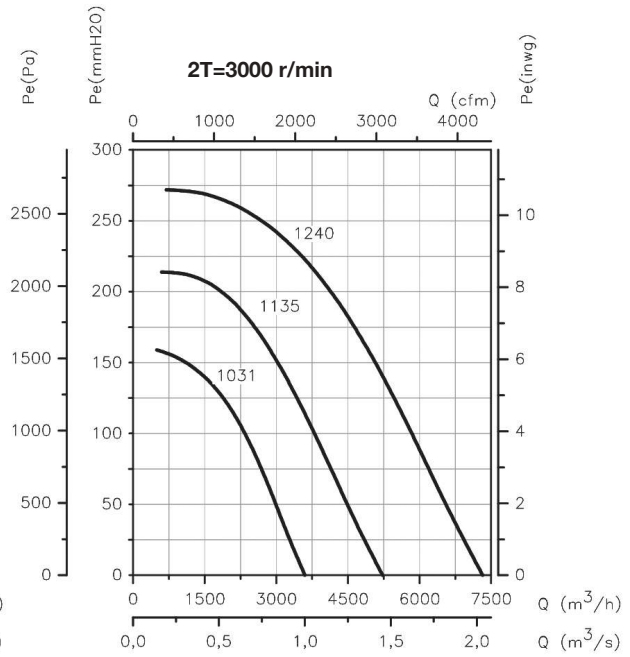
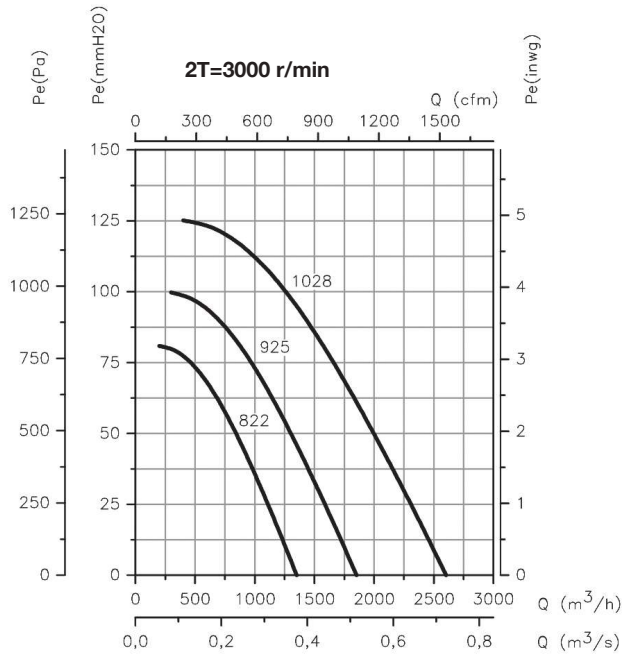

SMALL SERIES

Orientaciones

Suministro standard LG 270

Posiciones LG 180 y RD 180 bajo demanda con medidas de anclaje especiales

Los modelos 822, 925, 1028 y 1031 no admiten posición LG 135 ni RD 135

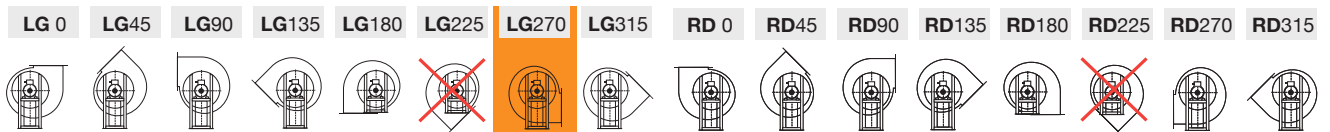

Accesorios



CMR

Ventiladores centrífugos de media presión y simple aspiración, de gran robustez, equipados con turbina a reacción



Ventilador:

- Envoltente en chapa de acero.
- Turbina a reacción en chapa de acero de gran robustez.

Motor:

- Motores con eficiencia IE3 para potencias iguales o superiores a 0,75 kW, excepto monofásicos, 2 velocidades y 8 polos.
- Motores clase F con rodamientos a bolas. Protección IP55.
- Trifásicos 230/400 V 50 Hz (hasta 4 kW) y 400/690 V 50 Hz (potencias superiores a 4 kW).
- Temperatura máxima del aire a transportar: -20 °C +120 °C.

Acabado:

- Anticorrosivo en resina de poliéster polimerizada a 190 °C, previo desengrase con tratamiento nanotecnológico libre de fosfatos.

Bajo demanda:

- Bobinados especiales para diferentes tensiones.
- Ventilador preparado para transportar aire hasta +250 °C.
- Ventilador en acero inoxidable.
- Certificación ATEX Categoría 2 (ver serie CMR/ATEX).

Código de pedido

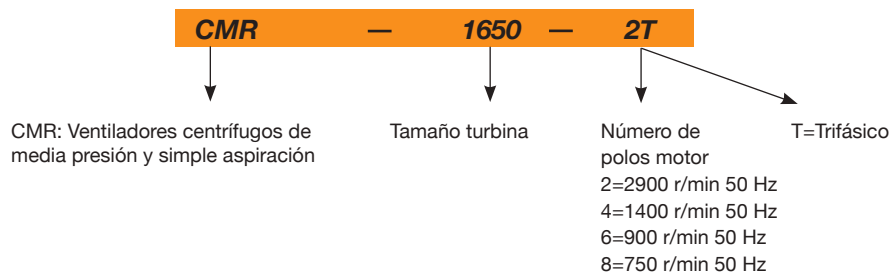

Características técnicas

Modelo	Velocidad (r/min)	Intensidad máxima admisible (A)			Potencia instalada (kW)	Caudal máximo (m³/h)	Nivel presión sonora dB(A)	Peso aprox. (Kg)	According ErP
		230V	400V	690V					
CMR-1031-2T IE3	2875	5,34	3,07		1,50	5160	80	48	2015
CMR-1135-2T IE3	2910	7,32	4,21		2,20	7800	83	59	2015
CMR-1240-2T IE3	2900	13,00	7,50		4,00	11100	86	103	2015
CMR-1240-4T IE3	1420	2,82	1,62		0,75	5800	71	72	2015
CMR-1445-2T IE3	2930		14,10	8,17	7,50	16500	87	122	2015
CMR-1445-4T IE3	1455	4,07	2,34		1,10	8030	72	97	2015
CMR-1650-2T IE3	2945		20,00	11,60	11,00	18850	89	210	2015
CMR-1650-4T IE3	1440	5,41	3,11		1,50	10500	74	122	2015
CMR-1856-4T IE3	1440	10,70	6,15		3,00	15150	79	157	2015
CMR-2063-4T IE3	1465		10,30	5,97	5,50	24450	80	249	2015
CMR-2063-6T IE3	950	6,43	3,70		1,50	16100	71	212	2015
CMR-2271-4T IE3	1470		20,90	12,10	11,00	34610	85	340	2015
CMR-2271-6T IE3	970	12,00	6,91		3,00	22750	76	294	2015
CMR-2380-4T IE3	1470		41,00	23,80	22,00	48000	83	431	2015
CMR-2380-6T IE3	975		14,80	8,58	7,50	30000	75	398	2015



Erp. (Energy Related Products)

Información de la Directiva 2009/125/EC descargable desde la web de SODECA o programa de selección QuickFan

Características acústicas

Los valores indicados, se determinan mediante medidas de nivel de presión y potencia sonora en dB(A) obtenidas en campo libre a una distancia equivalente a dos veces la envergadura del ventilador más el diámetro de la turbina, con un mínimo de 1,5 mts.

Espectro de potencia sonora Lw(A) en dB(A) por banda de frecuencia en Hz.

Modelo	63	125	250	500	1000	2000	4000	8000	Modelo	63	125	250	500	1000	2000	4000	8000
1031-2	65	78	78	91	86	86	86	79	1856-4	69	78	91	87	90	91	85	71
1135-2	72	79	77	89	87	93	92	79	2063-4	80	85	91	93	91	88	81	73
1240-2	68	83	81	93	90	94	96	83	2063-6	69	70	82	82	81	83	73	63
1240-4	56	70	76	79	79	80	70	59	2271-4	83	84	93	96	98	99	95	82
1445-2	73	85	83	95	93	97	99	89	2271-6	73	73	87	86	90	90	79	68
1445-4	59	72	78	83	80	83	78	64	2380-4	76	78	94	91	96	97	93	82
1650-2	73	81	85	99	97	99	99	88	2380-6	68	70	86	83	88	89	85	74
1650-4	64	74	82	84	83	85	76	66									

Dimensiones mm

CMR-1031...2271

Boca de aspiración

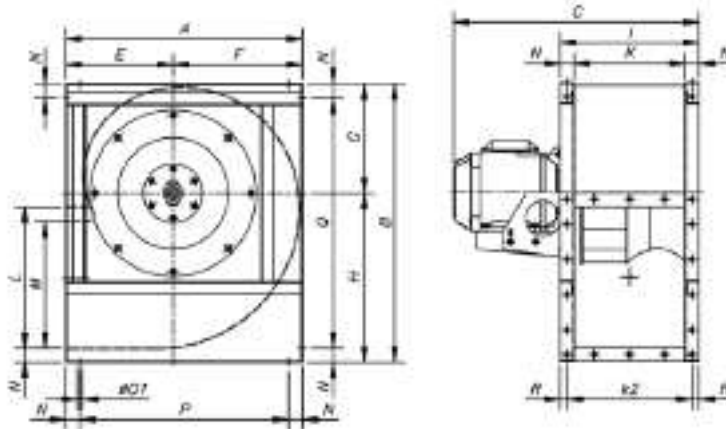

	A	B	C	øD1*	ød	ød1	ød2	E	F	G	H	I	K	k2	L	M	N	øO1	P	Q	R
CMR-1031-2T	542	626	573,5	315	383	356	M8	250	292	245	381	320	250	285	315	276	35	11	472	556	17,5
CMR-1135-2T	600	696	656	355	425	398	M8	275	325	273	423	350	280	315	355	310	35	11	530	626	17,5
CMR-1240-2T	673	790	728	400	472	444	M10	305	368	310	480	395	315	355	400	358	40	11	593	710	20
CMR-1240-4T	673	790	590	400	472	444	M10	305	368	310	480	395	315	355	400	358	40	11	593	710	20
CMR-1445-2T	765	880	810	450	522	494	M10	350	415	339	541	445	355	403	450	404	45	11	675	790	21
CMR-1445-4T	765	880	649	450	522	494	M10	350	415	339	541	445	355	403	450	404	45	11	675	790	21
CMR-1650-2T	832	970	961	500	582	555	M10	375	457	378	592	490	400	450	500	445	45	13	742	880	20
CMR-1650-4T	832	970	715	500	582	555	M10	375	457	378	592	490	400	450	500	445	45	13	742	880	20
CMR-1856-4T	925	1084	832	560	645	615	M10	415	510	426	658	550	450	500	560	493	50	13	825	984	25
CMR-2063-4T	1037	1218	973	630	720	688	M10	465	572	477	741	620	500	560	630	530	60	13	917	1098	30
CMR-2063-6T	1037	1218	893	630	720	688	M10	465	572	477	741	620	500	560	630	530	60	13	917	1098	30
CMR-2271-4T	1173	1375	1126	710	800	768	M12	525	648	538	837	690	560	625	710	603	65	13	1043	1245	32,5
CMR-2271-6T	1173	1375	1039	710	800	768	M12	525	648	538	837	690	560	625	710	603	65	13	1043	1245	32,5

* Diámetro nominal tubería recomendada

SMALL SERIES

Dimensiones mm

CMR-2380

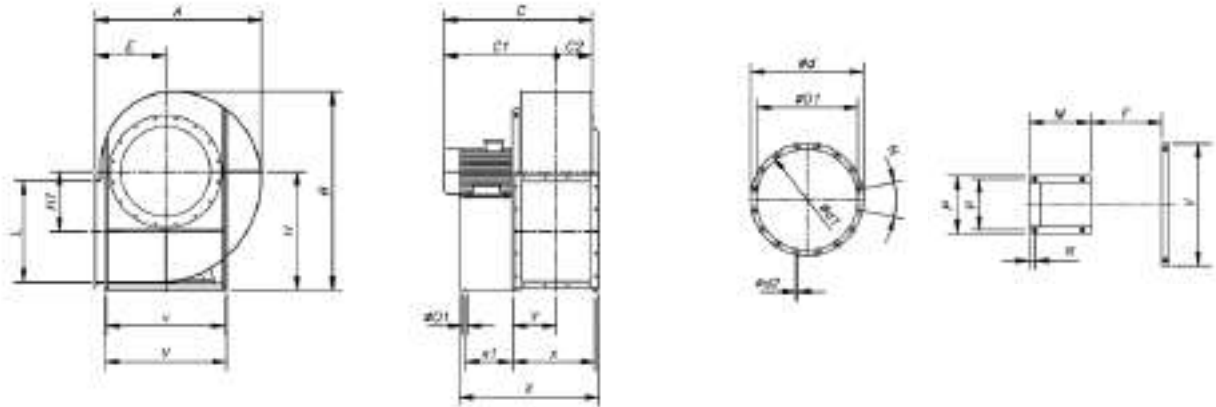

	A	B	C	C1	C2	ØD1	Ød	Ød1	Ød2	E	H	H1	L	F	M	R	N	ØO1	P
CMR-2380-4T	1312	1592	1174	882	292	805	920	861	15	560	950	482	808	574	543	39	16x22°30'	19	926
CMR-2380-6T	1312	1592	1055	763	292	805	920	861	15	560	950	482	808	574	474	39	16x22°30'	19	926

	p	V	v	X	x	x1	Y
CMR-2380-4T	862	965	862	1184	675	441	353
CMR-2380-6T	862	965	862	1115	675	372	353

Boca Impulsión

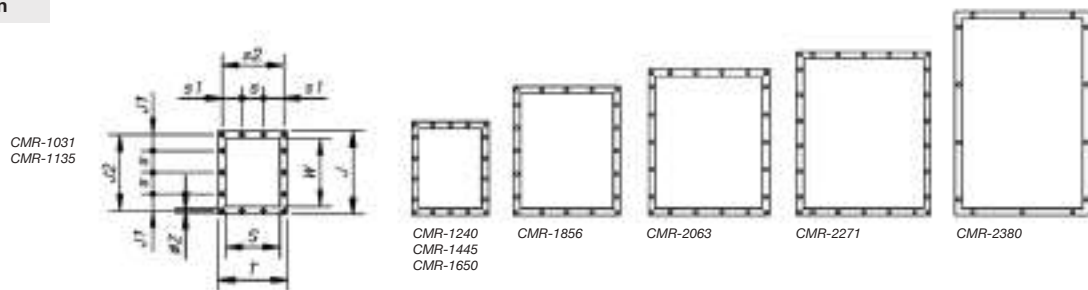

	T	J	J1	J2	S	s	s1	s2	W	Øz
CMR-1031	320	385	75	350	250	100	92,5	285	315	9
CMR-1135	350	425	95	390	280	100	107,5	315	355	9
CMR-1240	395	480	70	440	315	100	77,5	355	400	11
CMR-1445	445	540	99	498	355	100	102,5	403	450	11
CMR-1650	490	590	88	550	400	125	100	450	500	11
CMR-1856	550	660	55	610	450	125	125	500	560	13
CMR-2063	620	750	95	690	500	125	92,5	560	630	13
CMR-2271	690	840	75	775	560	125	62,5	625	710	13
CMR-2380	689	921	135	871	574	200	119	639	808	14

Curvas Características

Q= Caudal en m³/h, m³/s y cfm

Pe= Presión estática en mmH₂O, Pa e inwg

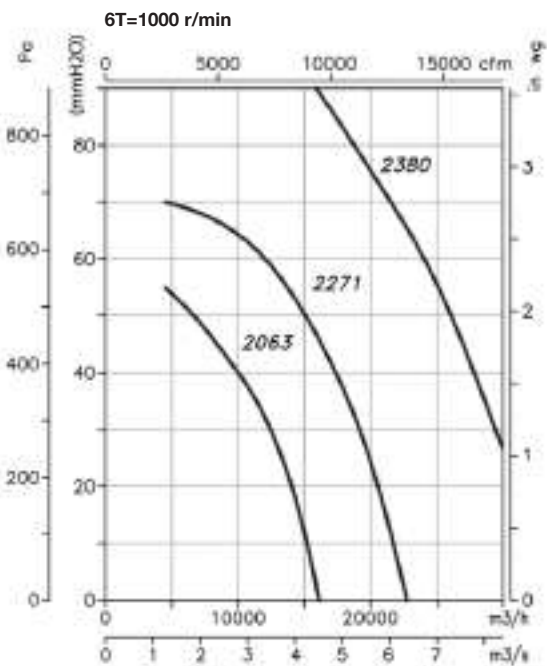
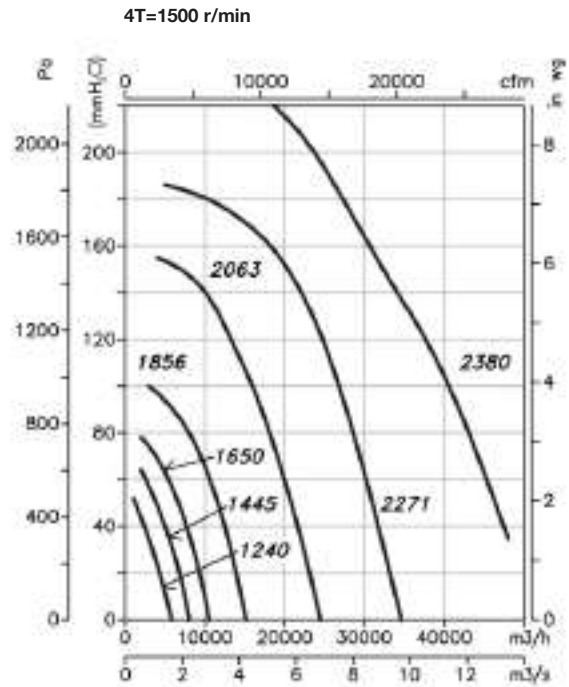
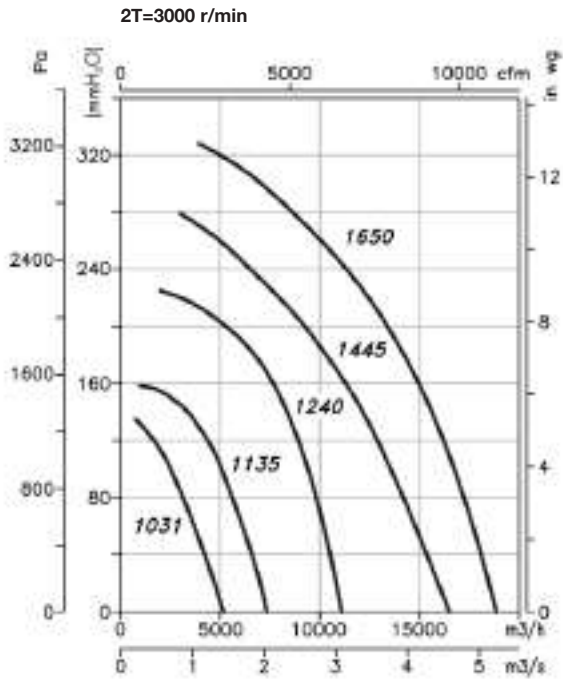

SMALL SERIES

Orientaciones

Suministro standard LG 270

Modelos 2380, 2590 y 28100 orientación fija LG 270 (otras orientaciones sólo bajo demanda)

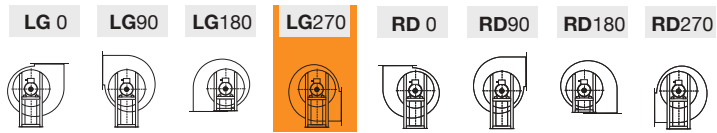

Accesorios



CBP CBPC



CBP: Ventiladores centrífugos de media presión y simple aspiración, equipados con turbina a reacción con efecto autolimpieza, especialmente diseñados para cabinas de pintura

CBPC: Ventiladores centrífugos de media presión y simple aspiración, equipados con turbina a reacción con efecto autolimpieza, especialmente diseñados para cabinas de pintura, con salida vertical



Ventilador:

- Envoltente en chapa de acero.
- Turbina a reacción en chapa de acero.
- Incorpora trampilla de inspección.
- CBPC: Con salida vertical.

Acabado:

- Anticorrosivo en resina de poliéster polimerizada a 190 °C, previo desengrase con tratamiento nanotecnológico libre de fosfatos.

Motor:

- Motores con eficiencia IE3 para potencias iguales o superiores a 0,75 kW, excepto monofásicos, 2 velocidades y 8 polos.
- Motores clase F con rodamientos a bolas. Protección IP55.
- Trifásicos 230/400 V 50 Hz (hasta 4 kW).
- Temperatura máxima del aire a transportar: -20 °C +120 °C.

Bajo demanda:

- Bobinados especiales para diferentes tensiones.
- Certificación ATEX Categoría 2.



Turbina a reacción de alto rendimiento, y gran robustez

Código de pedido

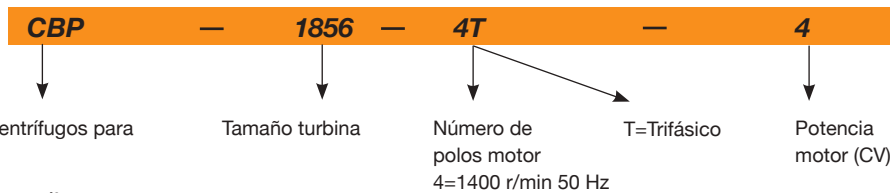

CBP: Ventiladores centrífugos para cabinas de pintura

CBPC: Ventiladores centrífugos para cabinas de pintura con salida vertical

Características técnicas

Modelo	Velocidad (r/min)	Intensidad máxima admisible (A)		Potencia instalada (kW)	Caudal máximo (m³/h)	Nivel presión sonora dB(A)	Peso aprox. (Kg)		According ErP
		230V	400V				CBP	CBPC	
CBP CBPC 1445-4T IE3	1455	4,07	2,34	1,10	8200	73	66	79	2015
CBP CBPC 1650-4T-2 IE3	1440	5,41	3,11	1,50	11050	76	87	103	2015
CBP CBPC 1650-4T-3 IE3	1435	7,93	4,56	2,20	13500	78	93	101	2015
CBP CBPC 1556-4T IE3	1440	10,70	6,15	3,00	14000	80	127	154	2015
CBP CBPC 1856-4T-4 IE3	1440	10,70	6,15	3,00	16100	80	127	154	2015
CBP CBPC 1856-4T-5.5 IE3	1450	13,90	8,00	4,00	17200	82	130	157	2015



Erp. (Energy Related Products)

Información de la Directiva 2009/125/EC descargable desde la web de SODECA o programa de selección QuickFan

Características acústicas

Espectro de potencia sonora Lw(A) en dB(A) por banda de frecuencia en Hz

Modelo	63	125	250	500	1000	2000	4000	8000	Modelo	63	125	250	500	1000	2000	4000	8000
CBP-1445	60	73	79	84	81	84	79	65	CBPC-1445	60	73	79	84	81	84	79	65
CBP-1650	66	76	84	86	85	87	78	68	CBPC-1650	66	76	84	86	85	87	78	68
CBP-1556	68	77	90	86	89	90	84	70	CBPC-1556	68	77	90	86	89	90	84	70
CBP-1856	70	79	92	88	91	92	86	72	CBPC-1856	70	79	92	88	91	92	86	72

Dimensiones mm

CBP

Boca de aspiración

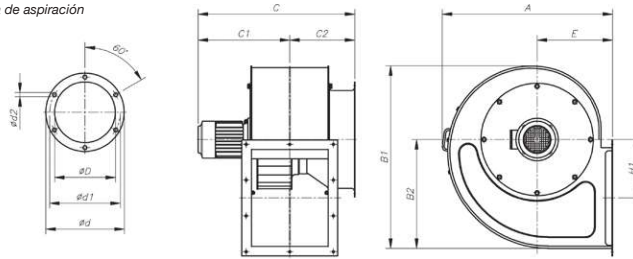

Boca de impulsión

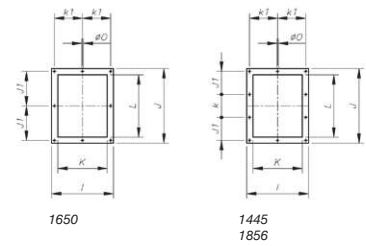

	A	B1	B2	C	C1	C2	øD	ød	ød1	ød2	E	H1	I	J	J1	K	k	k1	L	øO
CBP-1445-4T	789	847	505	777	425	302	450	534	500	12	350	271	445	538	166	355	166	202,5	450	11
CBP-1650-4T-2	856	932	555	902	485	365	512	590	565	12	375	297	490	590	275	400	-	225	500	13
CBP-1650-4T-3	856	932	555	936	485	365	512	590	565	12	375	297	490	590	275	400	-	225	500	13
CBP-1556-4T	947	1041	617	954	567	348	560	634	610	12	415	328	550	660	203	450	203	250	560	13
CBP-1856-4T-4	947	1041	617	945	567	348	560	634	610	12	415	328	550	660	203	450	203	250	560	13
CBP-1856-4T5,5	947	1041	617	928	567	348	560	634	610	12	415	328	550	660	203	450	203	250	560	13

CBPC

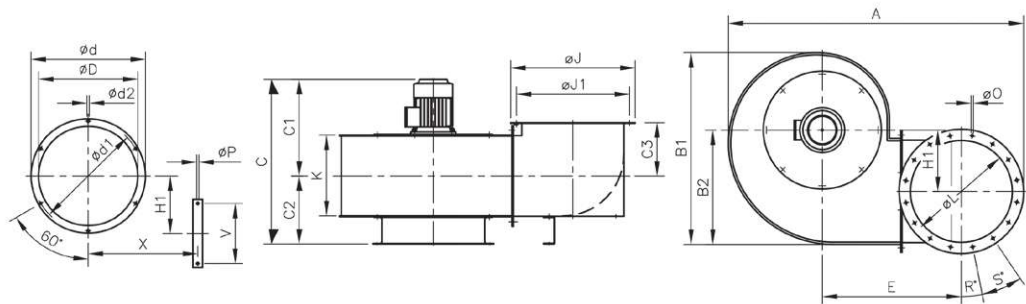

	A	B1	B2	C	C1	C2	C3	øD	ød	ød1	ød2	E	H1	øJ	øJ1	K	øL	øO	R°	S°	øP	V	X
CBPC-1445-4T	1307	847	505	777	477	300	236	450	534	500	12	617	271	550	500	361	450	M8	-	8x45°	11	260	512
CBPC-1650-4T-2	1428	932	555	903	540	363	256	512	590	565	12	672	297	600	560	404	500	M8	15°	12x30°	11	310	567
CBPC-1650-4T-3	1428	932	555	936	573	363	256	512	590	565	12	672	297	600	560	404	500	M8	15°	12x30°	11	310	567
CBPC-1556-4T	1580	1041	617	954	603	351	296	560	634	610	12	732	328	680	629	456	560	M12	11°15'	16x22°30'	11	360	622
CBPC-1856-4T-4	1580	1041	617	945	599	346	296	560	634	610	12	732	328	680	629	456	560	M12	11°15'	16x22°30'	11	360	622
CBPC-1856-4T5,5	1580	1041	617	928	582	346	296	560	634	610	12	732	328	680	629	456	560	M12	11°15'	16x22°30'	11	360	622

Curvas Características

Q= Caudal en m³/h, m³/s y cfm

Pe= Presión estática en mmH₂O, Pa e inwg

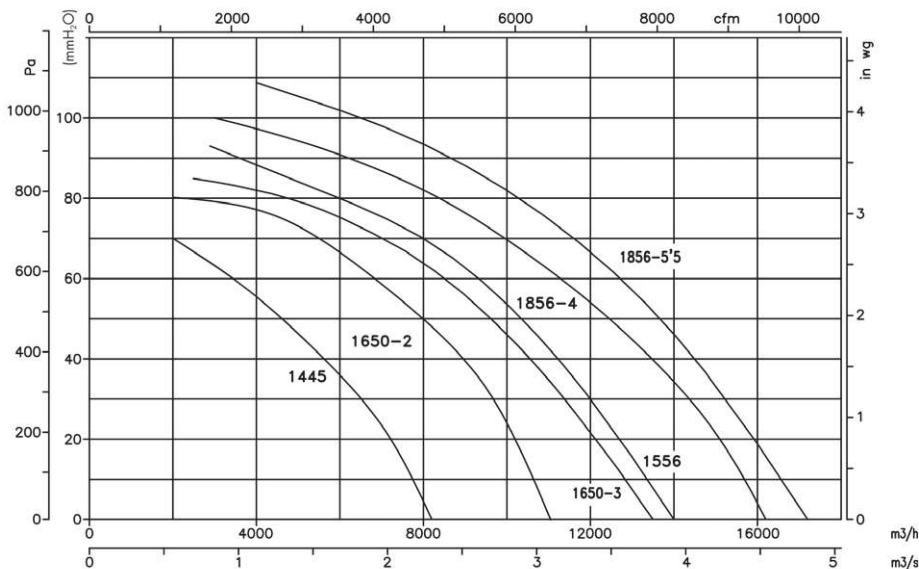

Orientaciones

Suministro standard LG 270

LG270

RD270



Accesorios



CMA



Ventiladores centrífugos de media presión y simple aspiración con envoltorio y turbina en fundición de aluminio



Ventilador:

- Envoltorio en fundición de aluminio.
- Turbina en fundición de aluminio.
- Modelos 324, 325 y 426 turbina en poliamida, modelo 531-2T-3 turbina en chapa de acero.

Motor:

- Motores con eficiencia IE3 para potencias iguales o superiores a 0,75 kW, excepto monofásicos, 2 velocidades y 8 polos.
- Motores clase F con rodamientos a bolas y protección IP55. Excepto modelos monofásicos con protección IP54.
- Monofásico 230 V 50 Hz y trifásico 230/400 V 50 Hz.
- Temperatura máxima del aire a transportar: -20 °C +120 °C, máximo +70 °C los modelos con turbina de poliamida.

Acabado:

- Anticorrosivo en resina de poliéster polimerizada a 190 °C, previo desengrase con tratamiento nanotecnológico libre de fosfatos.

Bajo demanda:

- Bobinados especiales para diferentes tensiones.
- Turbinas en fundición de aluminio para los modelos 324, 325 y 426.
- Ventilador preparado para transportar aire hasta +250 °C.
- Certificación ATEX Categoría 2 (ver serie CMA/ATEX).



Posibilidad de diferentes posiciones de impulsión

Código de pedido



CMA: Ventiladores centrífugos de media presión y simple aspiración con envoltorio y turbina en fundición de aluminio

Tamaño turbina

Número de polos motor
2=2900 r/min 50 Hz

T=Trifásico
M=Monofásico

Potencia motor (CV)

Características técnicas

Modelo	Velocidad (r/min)	Intensidad máxima admisible (A)		Potencia instalada (kW)	Caudal máximo m3/h	Nivel presión sonora dB (A)	Peso aprox. (Kg)	According ErP
		230V	400V					
CMA-218-2T	2670	0,64	0,37	0,09	265	63	6	Excluded
CMA-218-2M	2760	0,79		0,09	265	63	6	Excluded
CMA-324-2T	2750	1,21	0,70	0,18	440	70	9	2015
CMA-324-2M	2780	1,42		0,18	440	70	9	2015
CMA-325-2T	2710	1,29	0,75	0,25	600	73	11	2015
CMA-325-2M	2780	1,84		0,25	600	73	11	2015
CMA-426-2T	2710	1,92	1,11	0,37	850	75	13	2015
CMA-426-2M	2780	2,53		0,37	850	75	13	2015
CMA-527-2T	2760	2,57	1,49	0,55	1000	80	15	2015
CMA-527-2M	2810	3,49		0,55	1000	80	15	2015
CMA-528-2T-1 IE3	2825	2,80	1,62	0,75	1250	82	29	2015
CMA-528-2M-1	2810	4,50		0,75	1250	82	24	2015
CMA-528-2T-1.5 IE3	2830	4,03	2,34	1,10	1750	83	27	2015
CMA-528-2M-1.5	2820	6,51		1,10	1750	83	26	2015
CMA-531-2T-1.5 IE3	2830	4,03	2,34	1,10	1790	84	30	2015
CMA-531-2M-1.5	2820	6,51		1,10	1790	84	29	2015
CMA-531-2T-2 IE3	2875	5,34	3,07	1,50	2000	85	35	2015
CMA-531-2M-2	2810	8,50		1,50	2000	85	31	2015
CMA-531-2T-3 IE3	2910	7,32	4,21	2,20	2400	86	35	2015
CMA-540-2T IE3	2875	5,34	3,07	1,50	2600	85	42	2015
CMA-545-2T-3 IE3	2910	7,32	4,21	2,20	2630	86	59	2015
CMA-545-2T-4 IE3	2910	10,00	5,77	3,00	3550	88	68	2015

SMALL SERIES

Características acústicas

Espectro de potencia sonora Lw(A) en dB(A) por banda de frecuencia en Hz

Modelo	63	125	250	500	1000	2000	4000	8000	Modelo	63	125	250	500	1000	2000	4000	8000
218	29	43	61	67	71	68	63	54	531-1,5	50	64	82	88	92	89	84	75
324	36	50	68	74	78	75	70	61	531-2	51	65	83	89	93	90	85	76
325	39	53	71	77	81	78	73	64	531-3	52	66	84	90	94	91	86	77
426	41	55	73	79	83	80	75	66	540	54	67	85	91	96	92	87	79
527	46	60	78	84	88	85	80	71	545-3	55	68	86	92	97	93	88	80
528-1	48	62	80	86	90	87	82	73	545-4	57	70	88	94	99	95	90	82
528-1,5	49	63	81	87	91	88	83	74									

Dimensiones mm

CMA-218...528

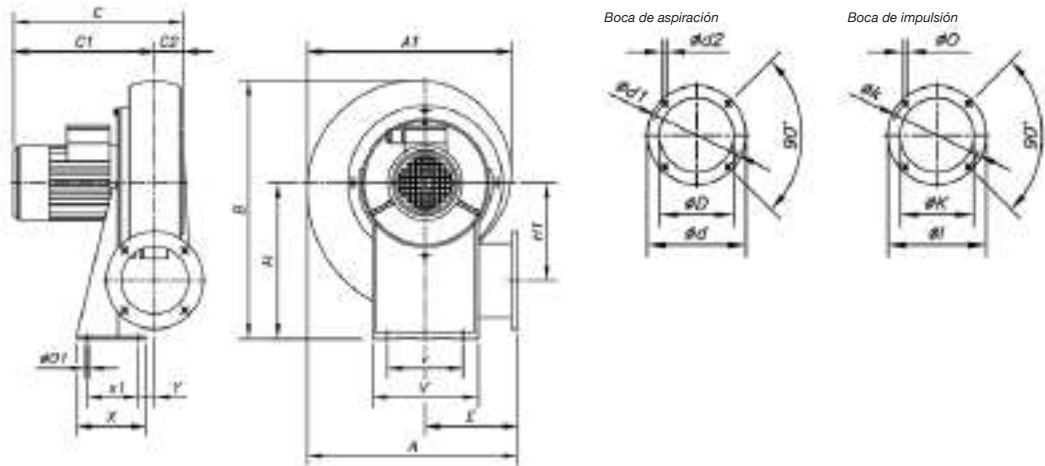

	A	A1	B	C	C1	C2	øD	ød	ød1	ød2	E	H	H1	øl	øk	øk	øO	øO1	V	v	X	x1	Y
CMA-218	241	236	288	239	207	32	80	113	95	M5	110	170	114,5	90	54	76	5,5	7	140	100	80	50	20
CMA-324	311	302	356	268	230	38	80	130	112	M5	145	205	145	108	62	90	7	9	173	125	90	60	20
CMA-325	335	328	399	271	231	40	94	140	122	M6	155	235	152	120	80	102	7	9	180	145	110	80	20
CMA-426	354	344	412	290	250	40	117	155	132	M6	162	240	163	140	90	119	7	13	210	160	105	65	26
CMA-527	371	361	440	297	255	42	125	170	147	M6	168	260	170	155	100	129	7	13	220	170	120	80	20
CMA-528...1	401	395	488	340	289	51	116	190	162	M6	178	290	177	190	130	160	11	13	230	180	140	100	20
CMA-528...1'5	401	395	488	337	289	48	135	190	162	M6	178	290	177	190	130	160	11	13	230	180	140	100	20

CMA-531

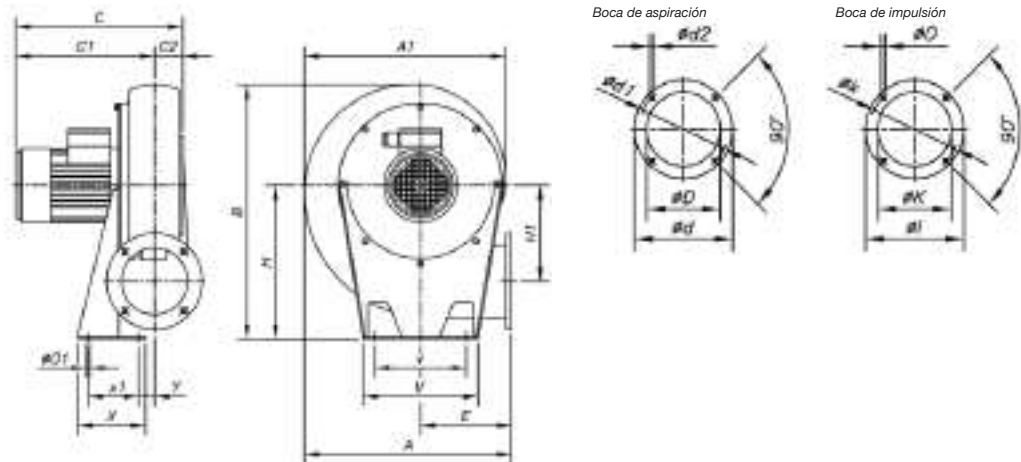

	A	A1	B	C	C1	C2	øD	ød	ød1	ød2	E	H	H1	øl	øk	øk	øO	øO1	V	v	X	x1	Y
CMA-531...1'5	440	434	537	340	290	50	160	215	180	M6	193	320	200	200	140	175	11	13	226	190	160	120	21
CMA-531...2	440	434	537	401	351	50	160	215	180	M6	193	320	200	200	140	175	11	13	226	190	160	120	21
CMA-531...3	440	434	537	401	351	50	160	215	180	M6	193	320	200	200	140	175	11	13	226	190	160	120	21

Dimensiones mm

CMA-540...545

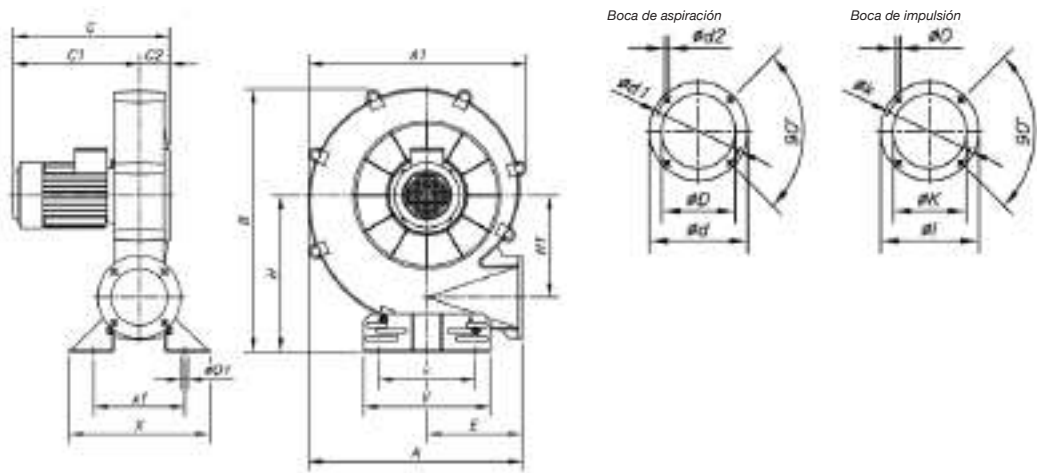

	A	A1	B	C	C1	C2	ØD	Ød	Ød1	Ød2	E	H	H1	Øl	ØK	Øk	ØO	ØO1	V	v	X	x1
CMA-540	567	580	695	403	323	80	170	240	205	M10	252	415	270	220	150	190	13	11	336	218	374	240
CMA-545...3	651	646	776	449	334	115	180	255	220	M10	290	450	309	250	175	220	13	13	336	238	392	292
CMA-545...4	651	646	776	468	353	115	180	255	220	M10	290	450	309	250	175	220	13	13	336	238	392	292

Curvas características

Q= Caudal en m³/h, m³/s y cfm

Pe= Presión estática en mmH₂O, Pa e inwg

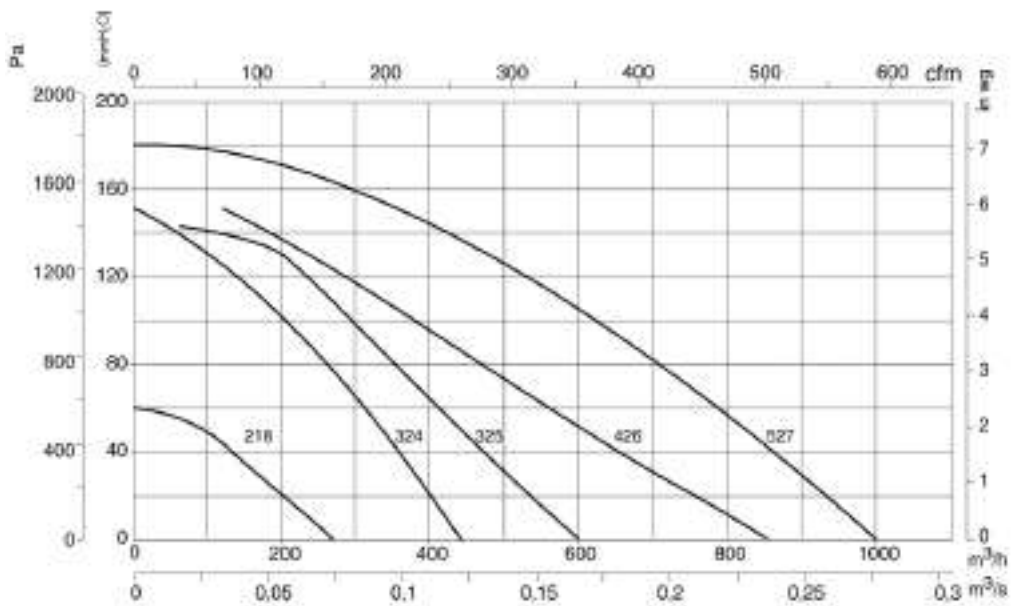

Curvas características

Q= Caudal en m³/h, m³/s y cfm

Pe= Presión estática en mmH₂O, Pa e inwg

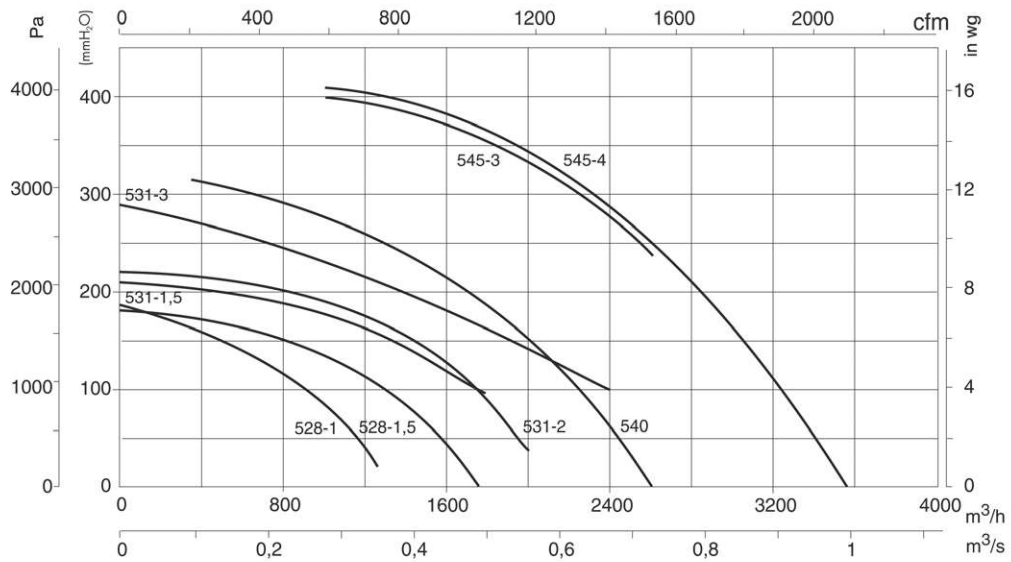

Orientaciones

Suministro standard LG 270

Posición LG 180 bajo demanda y con medidas de anclaje especiales

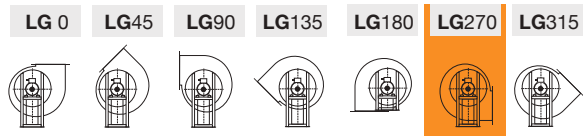

Accesorios



CPV



Ventiladores centrífugos anticorrosivos de simple aspiración fabricados en polipropileno



Ventilador:

- Envoltorio en polipropileno.
- Turbina a acción en polipropileno.

Motor:

- Motores con eficiencia IE3 para potencias iguales o superiores a 0,75 kW, excepto monofásicos, 2 velocidades y 8 polos.
- Motores clase F con rodamientos a bolas. Protección IP55.
- Trifásicos 230/400 V 50 Hz (hasta 4 kW) y 400/690 V 50 Hz (potencias superiores a 4 kW).
- Temperatura máxima del aire a transportar: -20 °C +70 °C.

Acabado:

- Anticorrosivo en material plástico.

Bajo demanda:

- Bobinados especiales para diferentes tensiones.
- Certificación ATEX Categoría 2.



Estético y moderno diseño

Código de pedido

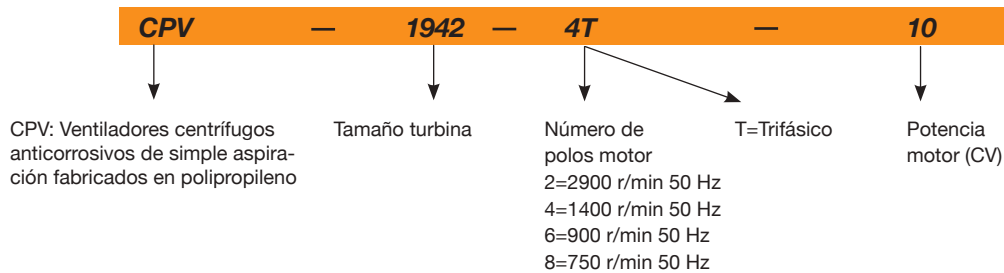

Características técnicas

Modelo	Velocidad (r/min)	Intensidad máxima admisible (A)			Potencia instalada (kW)	Caudal máximo (m3/h)	Nivel presión sonora (dB (A))	Peso aprox. (Kg)
		230V	400V	690V				
*CPV-720-2T	2710	1,92	1,11		0,37	525	75	10
CPV-815-2T	2710	1,92	1,11		0,37	950	75	14
CPV-815-4T	1350	1,52	0,88		0,25	450	58	14
*CPV-825-2T IE3	2830	4,03	2,34		1,10	1140	79	18
*CPV-930-2T IE3	2910	7,32	4,21		2,20	1750	84	29
CPV-1020-2T IE3	2825	2,80	1,62		0,75	2000	81	25
CPV-1020-4T	1350	1,52	0,88		0,25	1250	65	20
CPV-1325-2T IE3	2910	7,32	4,21		2,20	3250	87	32
CPV-1325-4T	1370	2,02	1,17		0,37	2300	69	27
CPV-1325-6T	900	1,51	0,87		0,25	1400	59	27
CPV-1630-4T IE3	1440	5,41	3,11		1,50	4500	75	43
CPV-1630-6T	900	2,99	1,73		0,55	2700	63	35
CPV-1840-4T IE3	1440	10,70	6,15		3,00	6000	70	53
CPV-1840-6T IE3	945	4,68	2,69		1,10	4200	65	48
*CPV-1942-4T-7.5 IE3	1465		10,30	5,97	5,50	8500	79	89
*CPV-1942-4T-10 IE3	1465		13,90	8,06	7,50	10500	84	93
*CPV-1942-6T IE3	950	9,08	5,22		2,20	7000	75	53
CPV-2045-4T IE3	1465		13,90	8,06	7,50	10400	78	118

*Sólo admiten orientación LG

Características acústicas

Los valores indicados, se determinan mediante medidas de nivel de presión y potencia sonora en dB(A) obtenidas en campo libre a una distancia equivalente a dos veces la envergadura del ventilador más el diámetro de la turbina, con un mínimo de 1,5 mts.

Espectro de potencia sonora Lw(A) en dB(A) por banda de frecuencia en Hz

Modelo	63	125	250	500	1000	2000	4000	8000	Modelo	63	125	250	500	1000	2000	4000	8000
720-2T	56	69	77	81	81	77	73	65	1325-6T	42	55	63	67	68	64	60	51
815-2T	56	69	77	81	81	77	73	65	1630-4T	60	73	81	85	86	82	78	69
815-4T	39	52	60	64	64	60	56	48	1630-6T	48	61	69	73	74	70	66	57
825-2T	60	73	81	85	85	81	77	69	1840-4T	55	68	76	80	81	77	73	64
930-2T	65	78	86	90	90	86	82	74	1840-6T	50	63	71	75	76	72	68	59
1020-2T	62	75	83	87	87	83	79	71	1942-4T-7.5	75	85	87	90	89	89	87	78
1020-4T	46	59	67	71	71	67	63	55	1942-4T-10	80	90	92	95	94	94	92	83
1325-2T	70	83	91	95	96	92	88	79	1942-6T	71	81	83	86	85	85	83	74
1325-4T	52	65	73	77	78	74	70	61	2045-4T	63	76	84	88	89	85	81	72

Dimensiones mm

CPV-720...1942

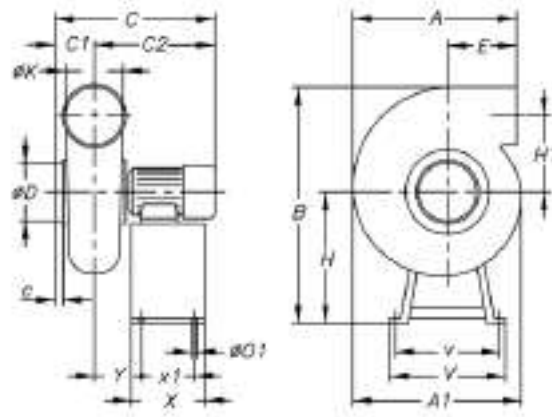

Fig.	A	A1	B	C	C1	C2	c	øD	E	H	H1	øK	øO1	V	v	X	x1	Y	
CPV-720	1	375	-	486	350	80	270	45	90	212	311	130	90	6	340	320	180	160	92
CPV-815	1	307	335	521	360	100	260	30	125	100	281	177,5	125	8	355	335	180	160	90
CPV-825	1	445	-	552	433	110	323	55	125	218	320	170	125	6	340	320	180	160	103
CPV-930	1	540	-	678	477	100	377	40	160	262	390	205	160	6	420	400	240	160	137
CPV-1020-2T	1	340	397	593	445,5	116	329,5	32	160	100	290	223	160	8	355	335	180	160	127,5
CPV-1020-4	1	340	397	584	422,5	116	306,5	32	160	100	281	223	160	8	355	335	180	160	122,5
CPV-1325-2T	1	413	505	735	494	130	364	35	200	103	370	265	200	8	400	380	180	160	125
CPV-1325-4/6T	1	413	505	716	432,5	130	302,5	35	200	103	351	265	200	8	400	380	180	160	113,5
CPV-1630-4T	1	480	602	890	536,5	145	391,5	35	250	117	440	323	250	8	450	430	240	220	142,5
CPV-1630-6T	1	480	602	880	503	145	358	35	250	117	430	323	250	8	450	430	240	220	138
CPV-1942-4T	1	580	750	1170	730,5	210	520,5	60	315	130	600	412,5	315	8	600	564	350	314	181,5
CPV-1942-6/8T	1	580	750	1150	679,5	210	469,5	60	315	130	580	412,5	315	8	600	564	350	314	204

Dimensiones mm

CPV-1840...2045

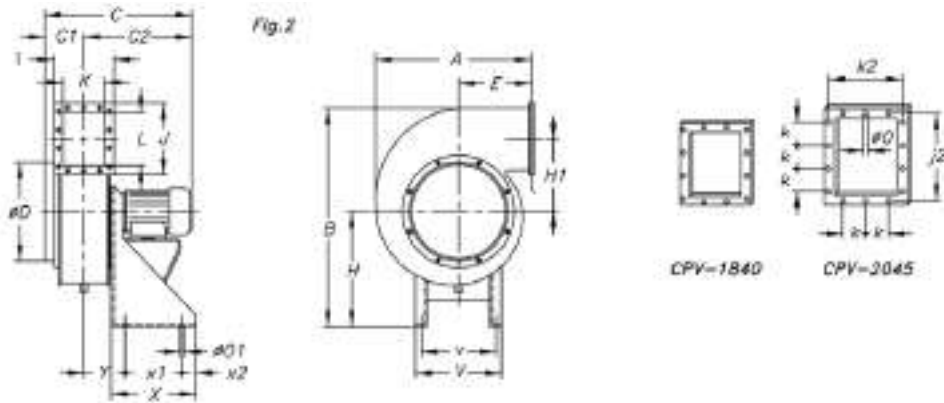

Fig.	A	B	C	C1	C2	øD	E	H	H1	I	J	j2	K	k	k2	L	
CPV-1840-4T	2	628	819	660	210	450	355	275	420	259	305	356	326	225	100	275	280
CPV-1840-6T	2	628	809	630	210	420	355	275	410	259	305	356	326	225	100	275	280
CPV-2045	2	724	1020	810	245	565	400	300	542	310	362	421	381	270	100	322	335

øO	øO1	V	v	X	x1	x2	Y	
CPV-1840-4T	9	12	320	285	300	200	50	170
CPV-1840-6T	9	12	320	285	300	200	50	170
CPV-2045	9	12	350	315	350	250	50	197

Curvas características

Q= Caudal en m³/h, m³/s y cfm

Pe= Presión estática en mmH₂O, Pa e inwg

2T=3000 r/min

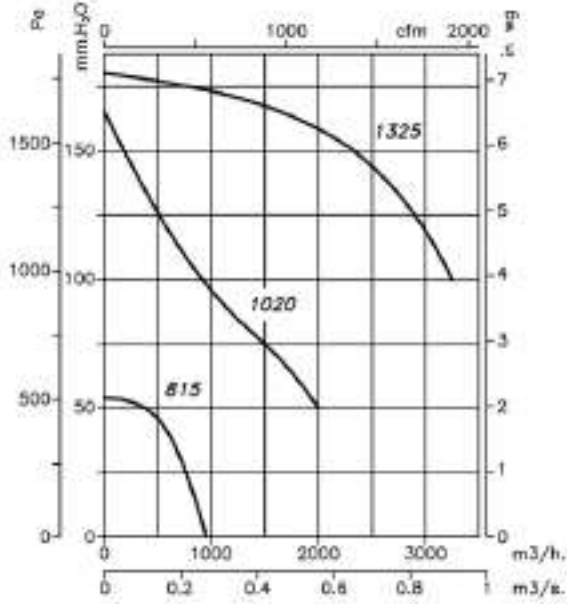

4T=1500 r/min

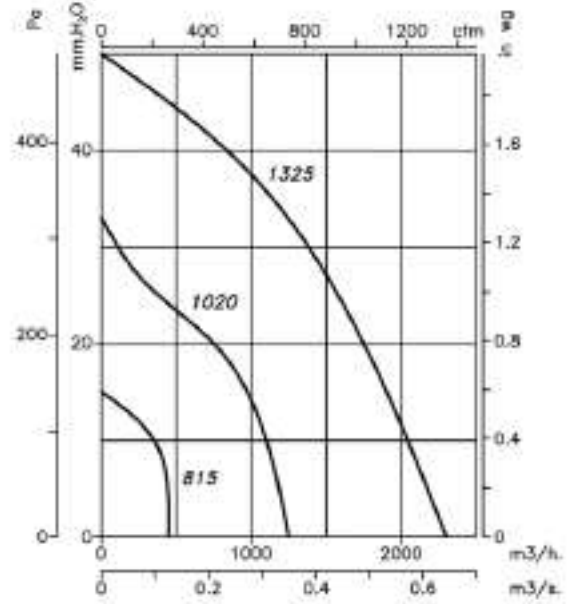

4T=1500 r/min

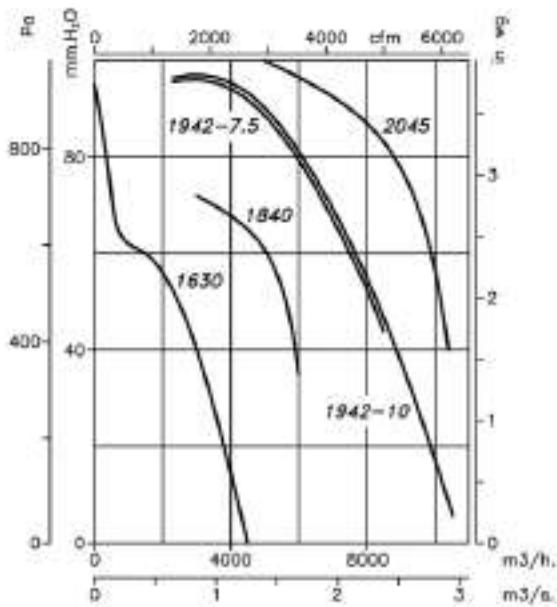

6T=1000 r/min

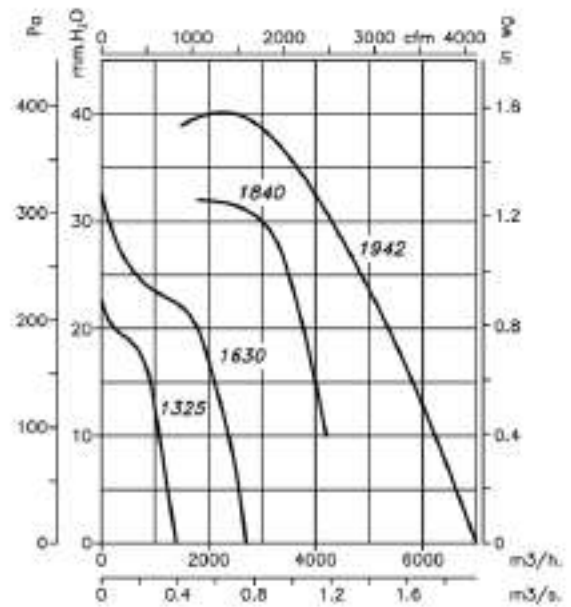

Curvas características

Q= Caudal en m³/h, m³/s y cfm

Pe= Presión estática en mmH₂O, Pa e inwg

2T=3000 r/min

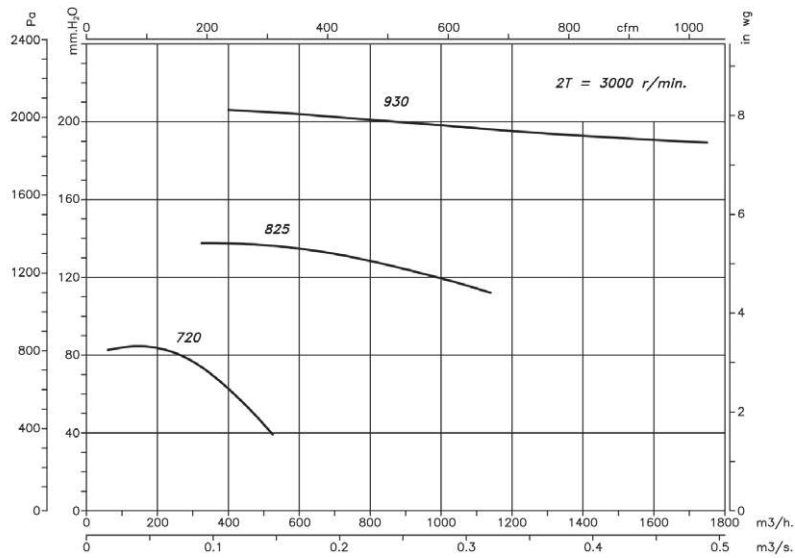

Orientaciones

Suministro standard LG 90

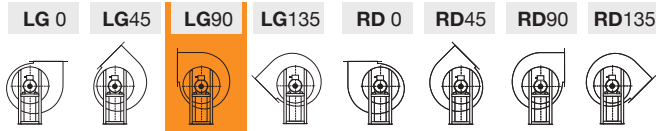

Accesorios



SMALL SERIES

CA



Ventiladores centrífugos de alta presión y simple aspiración con envolvente y turbina en fundición de aluminio



Ventilador:

- Envolvente en fundición de aluminio.
- Turbina en fundición de aluminio.

Motor:

- Motores con eficiencia IE3 para potencias iguales o superiores a 0,75 kW, excepto monofásicos, 2 velocidades y 8 polos.
- Motores clase F con rodamientos a bolas. Protección IP55.
- Trifásicos 230/400 V 50 Hz (hasta 4 kW) y 400/690 V 50 Hz (potencias superiores a 4 kW).
- Temperatura máxima del aire a transportar: -20 °C +120 °C.

Acabado:

- Anticorrosivo en resina de poliéster polimerizada a 190 °C, previo desengrase con tratamiento nanotecnológico libre de fosfatos.

Bajo demanda:

- Bobinados especiales para diferentes tensiones.
- Ventilador preparado para transportar aire hasta +250 °C.
- Certificación ATEX Categoría 2.



Construcción en aluminio de gran espesor para absorber ruidos y vibraciones

Código de pedido

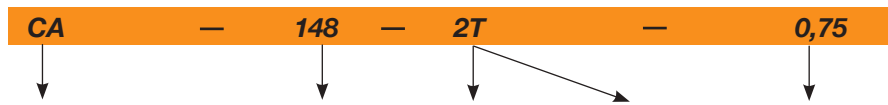

CA: Ventiladores centrífugos de alta presión y simple aspiración con envolvente y turbina en fundición de aluminio

Tamaño turbina

Número de polos motor
2=2900 r/min 50 Hz

T=Trifásico

Potencia motor (CV)

Características técnicas

Modelo	Velocidad (r/min)	Intensidad máxima admisible (A)			Potencia instalada (kW)	Caudal máximo (m³/h)	Nivel presión sonora dB(A)	Peso aprox. (Kg)	According ErP
		230V	400V	690V					
CA-234-2T	2710	1,92	1,11		0,37	220	72	10	*
CA-142-2T-0.33	2710	1,29	0,75		0,25	275	73	23	2015
CA-142-2T-0.5	2710	1,92	1,11		0,37	350	73	23	2015
CA-148-2T-0.75	2760	2,57	1,49		0,55	400	74	28	2015
CA-148-2T-1 IE3	2825	2,80	1,62		0,75	490	75	35	2015
CA-148-2T-1.5 IE3	2830	4,03	2,34		1,1	610	76	33	2015
CA-154-2T-2 IE3	2875	5,34	3,07		1,5	800	79	52	2015
CA-154-2T-3 IE3	2910	7,32	4,21		2,2	1280	80	55	2015
CA-160-2T-3 IE3	2910	7,32	4,21		2,2	900	84	63	2015
CA-166-2T-4 IE3	2910	10,00	5,77		3	950	85	77	2015
CA-166-2T-5.5 IE3	2900	13,00	7,50		4	1600	86	85	2015
CA-172-2T-7.5 IE3	2930		10,10	5,86	5,5	1710	88	135	2015
CA-172-2T-10 IE3	2930		14,10	8,17	7,5	2300	89	120	2015

* Equipos fuera de la Directiva 2009/125/EC

Características acústicas

Espectro de potencia sonora Lw(A) en dB(A) por banda de frecuencia en Hz.

	63	125	250	500	1000	2000	4000	8000		63	125	250	500	1000	2000	4000	8000
234	38	51	65	72	80	79	73	64	154-3	49	62	76	83	91	89	83	75
142	39	52	66	73	81	80	74	65	160-3	55	68	82	89	97	95	89	81
148-0,75	43	56	70	77	85	83	77	69	166-4	56	69	83	90	98	96	90	82
148-1	44	57	71	78	86	84	78	70	166-5,5	57	70	84	91	99	97	91	83
148-1,5	45	58	72	79	87	85	79	71	172-7,5	60	73	87	94	102	101	95	86
154-2	48	61	75	82	90	88	82	74	172-10	61	74	88	95	103	102	96	87



Erp. (Energy Related Products)

Información de la Directiva 2009/125/EC descargable desde la web de SODECA o programa de selección QuickFan

Dimensiones mm

CA-234

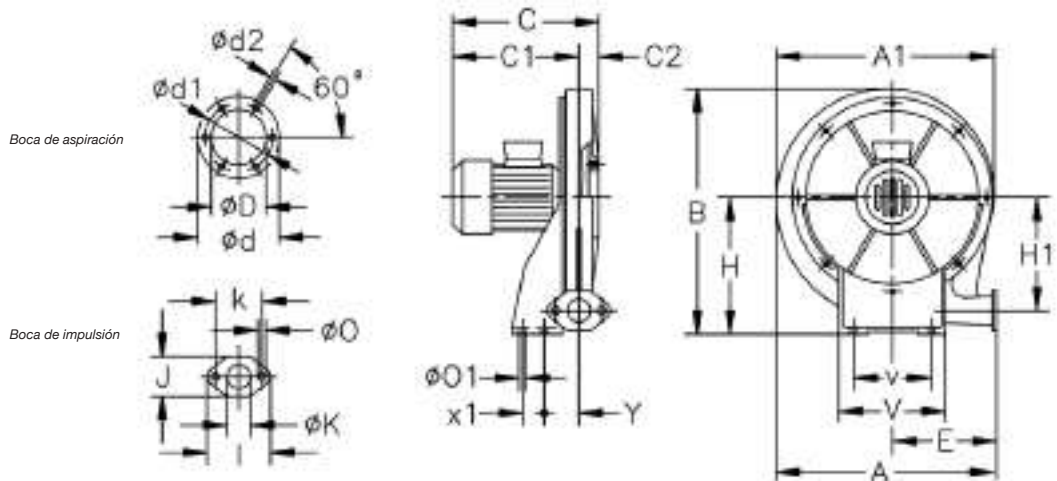

	A	A1	B	C	C1	C2	øD	ød	ød1	ød2	E	H	H1	I	J	øK	k	øO	øO1	V	v	x1	Y
CA-234-2T-0,33	376	381	415	261	236,5	24,5	98	130	115	M4	175	225	187	98	63	40	78	9	9	180	120	40	94

CA-142...148

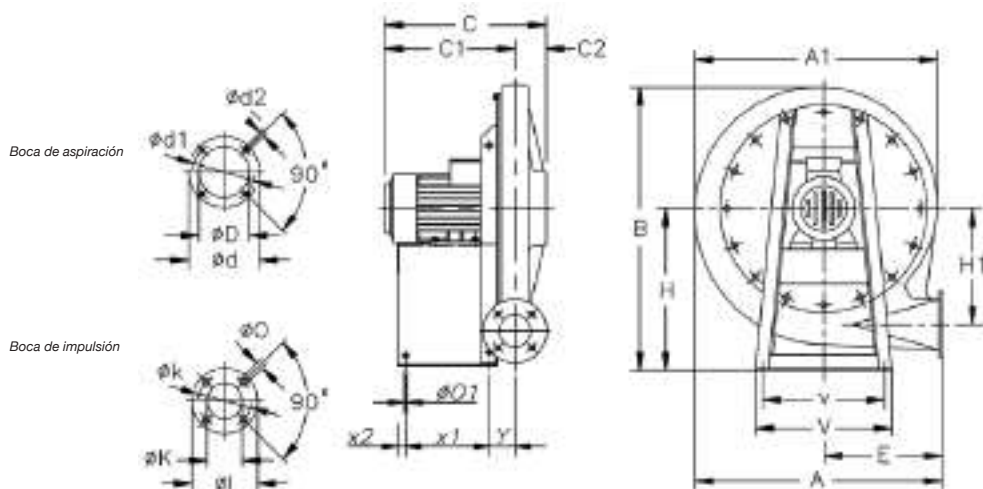

	A	A1	B	C	C1	C2	øD	ød	ød1	ød2	E	H	H1	øI	øK	øk	øO	øO1	V	v	x1	x2	Y
CA-142-2T-0'33	494	488	540	261	215	46	90	160	130	M8	240	301	235	120	60	90	11	12	300	270	130	20	47,5
CA-142-2T-0'5	494	488	540	291	245	46	90	160	130	M8	240	301	235	120	60	90	11	12	300	270	130	20	47,5
CA-148-2T-0'75	563	557,5	639	308,5	251,5	57	100	170	140	M8	270	360	269,5	150	73	110	11	12	330	290	140	20	60
CA-148-2T-1	563	557,5	639	331	274	57	100	170	140	M8	270	360	269,5	150	73	110	11	12	330	290	140	20	60
CA-148-2T-1'5	563	557,5	639	331	274	57	100	170	140	M8	270	360	269,5	150	73	110	11	12	330	290	140	20	60

Dimensiones mm

CA-154...172

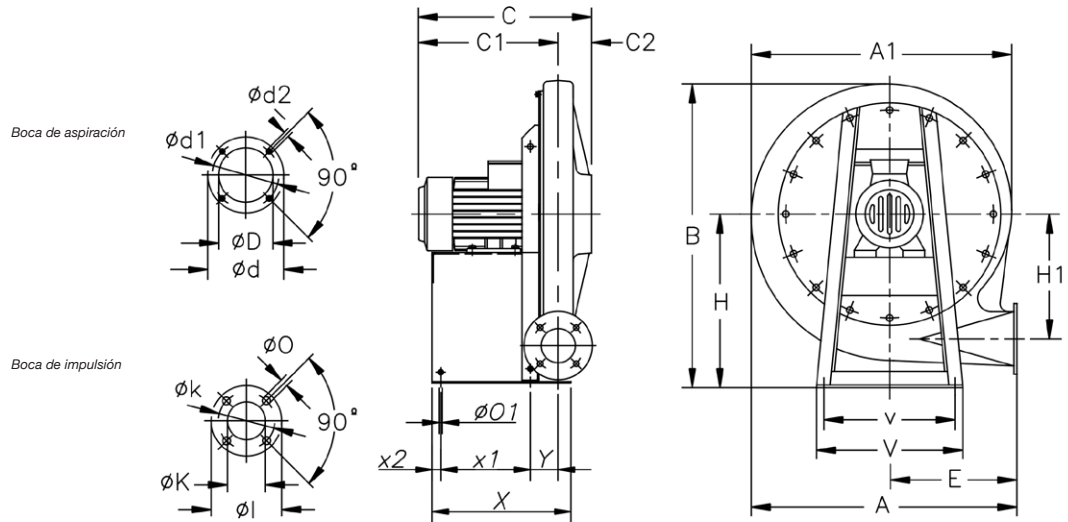

	A	A1	B	C	C1	C2	ØD	Ød	Ød1	Ød2	E	H	H1	Øl	ØK	Øk	ØØ	ØO1	V	v	X	x1	x2	Y
CA-154-2T-2	630	625	708	405	327	78	115	182	155	M10	300	395	308	160	80	120	13	12	356	320	325	210	20	65
CA-154-2T-3	630	625	708	396	316,5	78	115	182	155	M10	300	395	308	160	80	120	13	12	356	320	325	210	20	65
CA-160-2T-3	708	699	785	406	316	90	130	230	192	M10	336	440	338	160	85	120	13	12	373	322	344	220	23	68,5
CA-166-2T-4	759	752	866	435	357,5	77,5	140	230	200	M10	364	490	372	160	85	120	13	12	450	400	370	245	23	67,5
CA-166-2T-5,5	759	752	866	458	380	77,5	140	230	200	M10	364	490	372	160	85	120	13	12	450	400	390	265	23	70,5
CA-172-2T-7,5	818	813	923	507	426	80	148	230	200	M10	390	516	404	175	90	140	13	12	450	400	435	300	25	78
CA-172-2T-10	818	813	923	507	426	80	148	230	200	M10	390	516	404	175	90	140	13	12	450	400	435	300	25	78

Curvas Características

Q= Caudal en m³/h, m³/s y cfm

Pe= Presión estática en mmH₂O, Pa e inwg

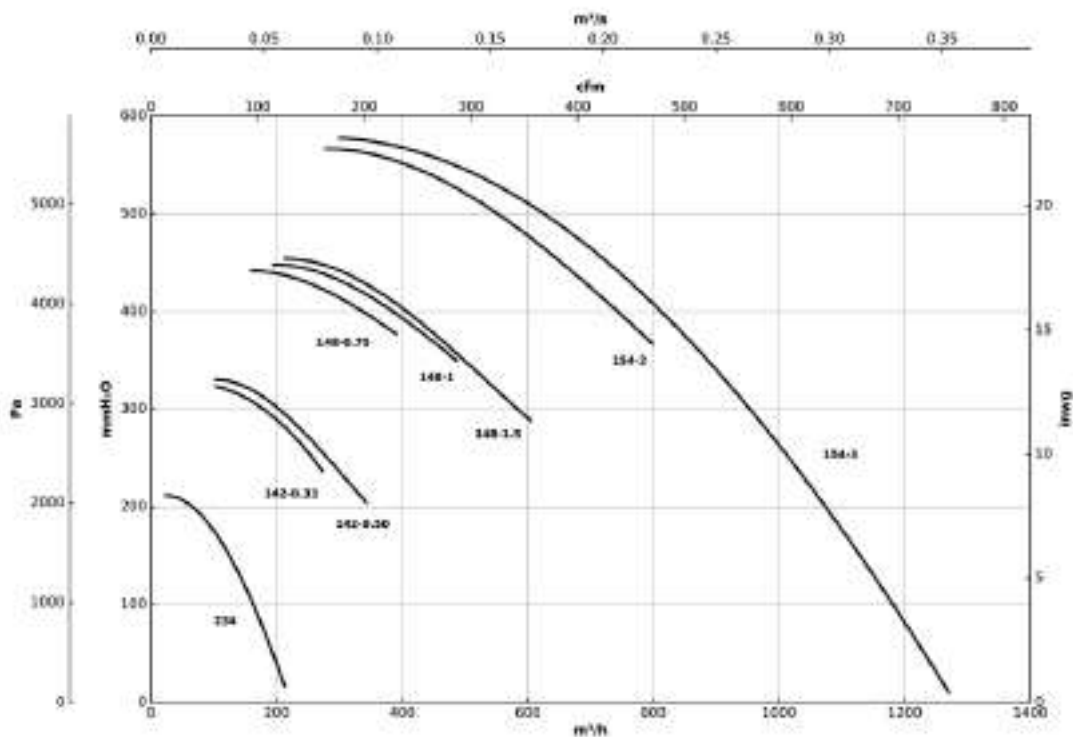

Curvas Características

Q= Caudal en m³/h, m³/s y cfm

Pe= Presión estática en mmH₂O, Pa e inwg

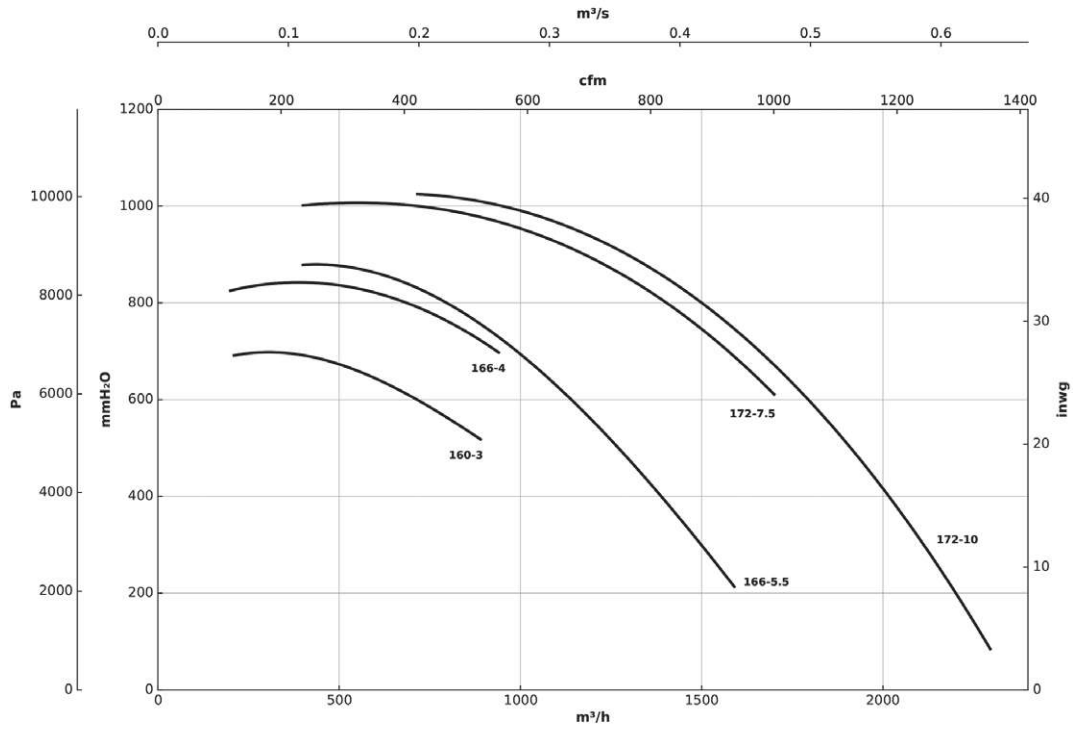

Orientaciones

Suministro standard LG 270

Posiciones LG 180 bajo demanda y con medidas de anclaje especiales.

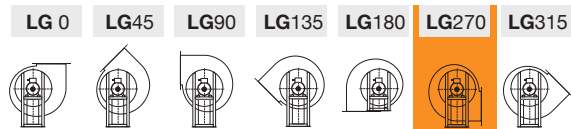

Accesorios



SMALL SERIES

CAS CAS-S

CAS: Ventiladores centrífugos de alta presión y simple aspiración con envoltente y turbina en chapa de acero

CAS-S: Ventiladores centrífugos de alta presión y simple aspiración con envoltente y turbina en chapa de acero, equipado con atenuador acústico



Ventilador:

- Envoltente en chapa de acero.
- Turbina a reacción en chapa de acero galvanizado, excepto modelos 242, 248, 254, 260, 640, 645 y 650 en turbina en fundición de aluminio.
- CAS-S: Atenuador acústico de perfil hexagonal incorporado en la boca de aspiración del ventilador. Su diseño permite ajustar el caudal de aire en la entrada del ventilador.

Motor:

- Motores con eficiencia IE3 para potencias iguales o superiores a 0,75 kW, excepto monofásicos, 2 velocidades y 8 polos.
- Motores clase F con rodamientos a bolas. Protección IP55.
- Trifásicos 230/400 V 50 Hz (hasta 4 kW) y 400/690 V 50 Hz (potencias superiores a 4 kW).

- Temperatura máxima del aire a transportar: -20 °C +120 °C.

Acabado:

- Anticorrosivo en resina de poliéster polimerizada a 190 °C, previo desengrase con tratamiento nanotecnológico libre de fosfatos.

Bajo demanda:

- Bobinados especiales para diferentes tensiones.
- Ventilador preparado para transportar aire hasta +250 °C.
- Ventilador en acero inoxidable.
- Certificación ATEX Categoría 2.



Bancada soporte motor de alta robustez

Código de pedido

CAS — 460 — 2T — 7,5

CAS: Ventiladores centrífugos de alta presión y simple aspiración

Tamaño turbina

Número de polos motor
2=2900 r/min 50 Hz

T=Trifásico

Potencia motor (CV)

CAS-S: Ventiladores centrífugos de alta presión y simple aspiración equipado con atenuador acústico

Características técnicas

Modelo	Velocidad (r/min)	Intensidad máxima admisible (A)			Potencia instalada (kW)	Caudal máximo (m³/h)	Nivel presión sonora dB(A)		Peso aprox. (Kg)		According ErP
		230V	400V	690V			CAS	CAS-S	CAS	CAS-S	
CAS CAS-S 242-2T-0.33	2710	1,29	0,75	0,25	450	73	67	30	33	2015	
CAS CAS-S 242-2T-0.5	2710	1,92	1,11	0,37	650	73	67	31	34	2015	
CAS CAS-S 248-2T-1 IE3	2825	2,80	1,62	0,75	500	75	69	50	53	2015	
CAS CAS-S 248-2T-1.5 IE3	2830	4,03	2,34	1,1	990	76	70	48	51	2015	
CAS CAS-S 254-2T-2 IE3	2875	5,34	3,07	1,5	800	78	72	65	68	2015	
CAS CAS-S 254-2T-3 IE3	2910	7,32	4,21	2,2	1300	80	73	68	71	2015	

Características técnicas

Modelo	Velocidad (r/min)	Intensidad máxima admisible (A)			Potencia instalada (kW)	Caudal máximo (m³/h)	Nivel presión sonora dB(A)		Peso aprox. (Kg)		According ErP
		230V	400V	690V			CAS	CAS-S	CAS	CAS-S	
CAS CAS-S 242-2T-0.33	2710	1,29	0,75		0,25	450	73	67	30	33	2015
CAS CAS-S 242-2T-0.5	2710	1,92	1,11		0,37	650	73	67	31	34	2015
CAS CAS-S 248-2T-1 IE3	2825	2,80	1,62		0,75	500	75	69	50	53	2015
CAS CAS-S 248-2T-1.5 IE3	2830	4,03	2,34		1,1	990	76	70	48	51	2015
CAS CAS-S 254-2T-2 IE3	2875	5,34	3,07		1,5	800	78	72	65	68	2015
CAS CAS-S 254-2T-3 IE3	2910	7,32	4,21		2,2	1300	80	73	68	71	2015
CAS CAS-S 260-2T-3 IE3	2910	7,32	4,21		2,2	900	79	72	83	88	2015
CAS CAS-S 463-2T-5.5 IE3	2900	13,00	7,50		4	1150	82	75	98	103	2015
CAS CAS-S 463-2T-7.5 IE3	2930		10,10	5,86	5,5	2000	83	76	119	124	2015
CAS CAS-S 467-2T-7.5 IE3	2930		10,10	5,86	5,5	1550	84	77	141	146	2015
CAS CAS-S 467-2T-10 IE3	2930		14,10	8,17	7,5	2600	85	78	119	124	2015
CAS CAS-S 571-2T-10 IE3	2930		14,10	8,17	7,5	2000	86	78	140	145	2015
CAS CAS-S 571-2T-15 IE3	2945		20,00	11,60	11	3450	87	79	207	212	2015
CAS CAS-S 640-2T-2 IE3	2875	5,34	3,07		1,5	2600	77	71	55	60	2015
CAS CAS-S 645-2T-3 IE3	2910	7,32	4,21		2,2	2000	76	70	67	75	2015
CAS CAS-S 645-2T-4 IE3	2910	10,00	5,77		3	3000	81	74	73	81	2015
CAS CAS-S 650-2T-5.5 IE3	2900	13,00	7,50		4	3500	81	74	98	106	2015
CAS CAS-S 650-2T-7.5 IE3	2930		10,10	5,86	5,5	4750	83	76	119	127	2015
CAS CAS-S 852-2T-7.5 IE3	2930		10,10	5,86	5,5	3500	81	74	119	127	2015
CAS CAS-S 852-2T-10 IE3	2930		14,10	8,17	7,5	5500	85	78	97	105	2015
CAS CAS-S 856-2T-15 IE3	2945		20,00	11,60	11	7500	85	78	190	200	2015
CAS CAS-S 863-2T-15 IE3	2945		20,00	11,60	11	4000	84	77	200	210	2015
CAS CAS-S 863-2T-20 IE3	2945		27,70	16,10	15	7000	86	78	203	213	2015
CAS CAS-S 971-2T-30 IE3	2950		39,70	23,00	22	8100	88	80	324	334	2015
CAS CAS-S 971-2T-40 IE3	2960		54,50	31,60	30	12000	89	81	410	420	2015
CAS CAS-S 790-2T-20 IE3	2945		27,70	16,10	15	2100	88	80	269	274	Excluded
CAS CAS-S 980-2T-30 IE3	2950		39,70	23,00	22	4800	87	79	340	355	2015
CAS CAS-S 990-2T-50 IE3	2960		67,80	39,30	37	6000	90	82	480	495	Excluded
CAS CAS-S 1080-2T-40 IE3	2960		54,50	31,60	30	5400	88	80	450	465	Excluded
CAS CAS-S 1090-2T-60 IE3	2960		77,50	44,90	45	6000	91	83	620	635	Excluded

* Equipos fuera de la Directiva 2009/125/EC



Erp. (Energy Related Products)

Información de la Directiva 2009/125/EC descargable desde la web de SODECA o programa de selección QuickFan

Características acústicas

Espectro de potencia sonora Lw(A) en dB(A) por banda de frecuencia en Hz.

CAS

	63	125	250	500	1000	2000	4000	8000
242	50	61	67	76	83	82	79	72
248-1	52	63	69	78	85	84	81	74
248-1,5	53	64	70	79	86	85	82	75
254-2	57	68	73	83	90	89	86	79
254-3	56	68	76	85	90	92	89	82
260-3	55	71	71	85	90	90	87	80
463-5,5	57	69	82	91	93	93	89	80
463-7,5	58	70	83	92	94	94	90	81
467-7,5	69	74	83	95	95	97	93	85
467-10	70	75	84	96	96	98	94	86
571-10	64	76	86	96	99	99	94	86
571-15	65	77	87	97	100	100	95	87
640	56	67	75	82	88	84	83	76
645-3	55	66	74	81	87	83	82	75
645-4	55	66	77	86	90	91	87	79

	63	125	250	500	1000	2000	4000	8000
650-5,5	59	75	84	90	93	90	85	78
650-7,5	52	68	81	91	96	93	85	78
852-7,5	68	72	82	88	92	92	89	84
852-10	68	76	86	93	96	96	92	84
856	63	76	90	96	96	94	90	84
863-15	67	81	87	96	96	95	92	87
863-20	69	81	92	99	98	95	93	87
971-30	68	82	91	103	99	97	94	90
971-40	68	83	97	102	102	99	95	88
790	73	77	88	99	105	96	89	83
980	61	70	76	91	105	97	94	90
990	64	73	79	94	108	100	97	93
1080	62	71	77	92	106	98	95	91
1090	65	77	80	95	109	101	98	94

CAS-S

Espectro de potencia sonora Lw(A) en dB(A) por banda de frecuencia en Hz.

	63	125	250	500	1000	2000	4000	8000
242	44	55	61	70	77	76	73	66
248-1	46	57	63	72	79	78	75	68
248-1,5	47	58	64	73	80	79	76	69
254-2	51	62	67	77	84	83	80	73
254-3	49	61	69	78	83	85	82	75
260-3	48	64	64	78	83	83	80	73
463-5,5	50	62	75	84	86	86	82	73
463-7,5	51	63	76	85	87	87	83	74
467-7,5	62	67	76	88	88	90	86	78
467-10	63	68	77	89	89	91	87	79
571-10	56	68	78	88	91	91	86	78
571-15	57	69	79	89	92	92	87	79
640	50	61	69	76	82	78	77	70
645-3	49	60	68	75	81	77	76	69
645-4	48	59	70	79	83	84	80	72

	63	125	250	500	1000	2000	4000	8000
650-5,5	52	68	77	83	86	83	78	71
650-7,5	45	61	74	84	89	86	78	71
852-7,5	61	65	75	81	85	85	82	77
852-10	61	69	79	86	89	89	85	77
856	56	69	83	89	89	87	83	77
863-15	60	74	80	89	89	88	85	80
863-20	61	73	84	91	90	87	85	79
971-30	60	74	83	95	91	89	86	82
971-40	60	75	89	94	94	91	87	80
790	65	69	80	91	97	88	81	75
980	53	62	68	83	97	89	86	82
990	56	65	71	86	100	92	89	85
1080	54	63	69	84	98	90	87	83
1090	57	66	72	87	101	93	90	86

Dimensiones mm

CAS-242...971

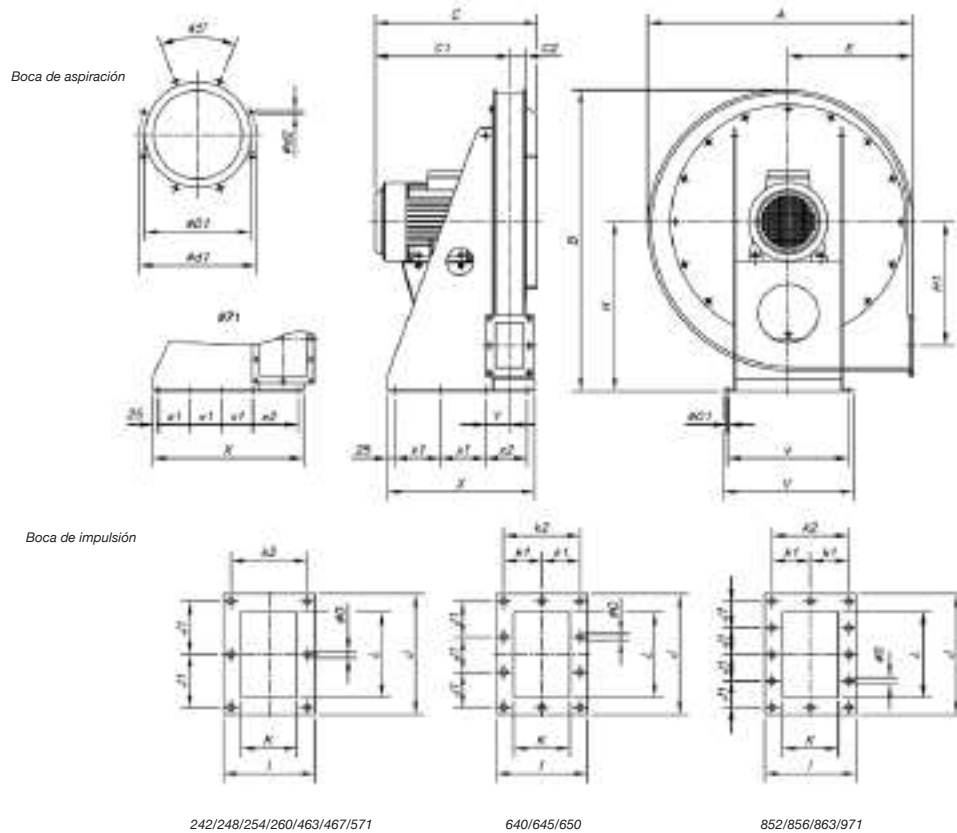

	A	B	C	C1	C2	øD1	øD1	øD2	E	H	H1	I	J	J1	K	k1	k2	L	øO	øO1	V	v	X	x1	x2	Y
CAS-242-2T-0'33	576	662	299	236	33	100	130	M8	270	375	270	120	155	65	60	-	95	95	11	12	305	275	260	75	-	61
CAS-242-2T-0'5	576	662	319	256	33	100	130	M8	270	375	270	120	155	65	60	-	95	95	11	12	305	275	260	75	-	61
CAS-248-2T-1'1'5	639	728	343	277	36	112	140	M8	300	410	297	126	165	70	66	-	101	105	11	12	320	290	300	90	-	64
CAS-254-2T-2	699	788	413	342,5	40,5	125	155	M8	330	440	322	135	175	75	75	-	110	115	11	14	340	310	330	100	-	68,5
CAS-254-2T-3	699	788	413	342,5	40,5	125	155	M8	330	440	322	135	175	75	75	-	110	115	11	14	340	310	330	100	-	68,5
CAS-260-2T-3	782	875	419	343	46	150	175	M8	370	485	362	145	185	80	85	-	120	125	11	14	380	350	370	115	-	73,5
CAS-463-2T-5'5	782	875	459	383,5	45,5	200	240	M8	370	485	362	145	185	80	85	-	120	125	11	14	380	350	370	115	-	73,5
CAS-463-2T-7'5	782	875	517	441,5	45,5	200	240	M8	370	485	362	145	185	80	85	-	120	125	11	14	380	350	370	115	-	73,5
CAS-467-2T-7'5/10	833	945	524	436	48	224	258	M8	390	530	395	150	190	82,5	90	-	125	130	11	14	405	375	300	125	-	76
CAS-571-2T-10	873	995	536	445,5	50,5	250	275	M8	410	560	410	155	205	90	95	-	130	145	11	14	430	400	350	150	-	79,5
CAS-571-2T-15	873	995	693	602,5	50,5	250	275	M8	410	560	410	155	205	90	95	-	130	145	11	14	430	400	410	180	-	79,5
CAS-640-2T-2	639	728	446	350,5	65,5	250	275	M8	300	410	250	185	260	78	125	80	160	200	11	14	340	310	350	100	-	93,5
CAS-645-2T-3	699	788	461	358	73	250	275	M8	330	440	267,5	200	284	86	140	87,5	175	224	11	14	380	350	380	115	-	101
CAS-645-2T-4	699	788	503	400	73	250	275	M8	330	440	267,5	200	284	86	140	87,5	175	224	11	14	380	350	380	115	-	101
CAS-650-2T-5'5	782	875	534	421	83	250	275	M8	370	485	300	220	310	95	160	97,5	195	250	11	14	405	375	490	125	190	111
CAS-650-2T-7'5	782	875	572	459	83	250	275	M8	370	485	300	220	310	95	160	97,5	195	250	11	14	405	375	490	125	190	111
CAS-852-2T-7'5/10	833	945	603	468,5	94,5	280	310	M8	390	530	320	240	340	78	180	107,5	215	280	11	14	430	400	540	150	190	122
CAS-856-2T-15	833	945	730	597	93	355	395	M8	390	530	320	240	340	78	180	107,5	215	280	11	14	430	400	600	180	190	122
CAS-863-2T-15/20	873	995	728	585	103	355	410	M8	410	560	325	260	375	87,5	200	117,5	235	315	11	14	430	400	620	180	210	132
CAS-971-2T-30	1012	1170	881	720	116	400	450	M10	460	670	420	294	425	100	224	132	264	355	11	14	550	510	715	150	215	145
CAS-971-2T-40	1012	1170	948	787	116	400	450	M10	460	670	420	294	425	100	224	132	264	355	11	14	550	510	715	150	215	145

SMALL SERIES

Dimensiones mm

CAS-790...1090

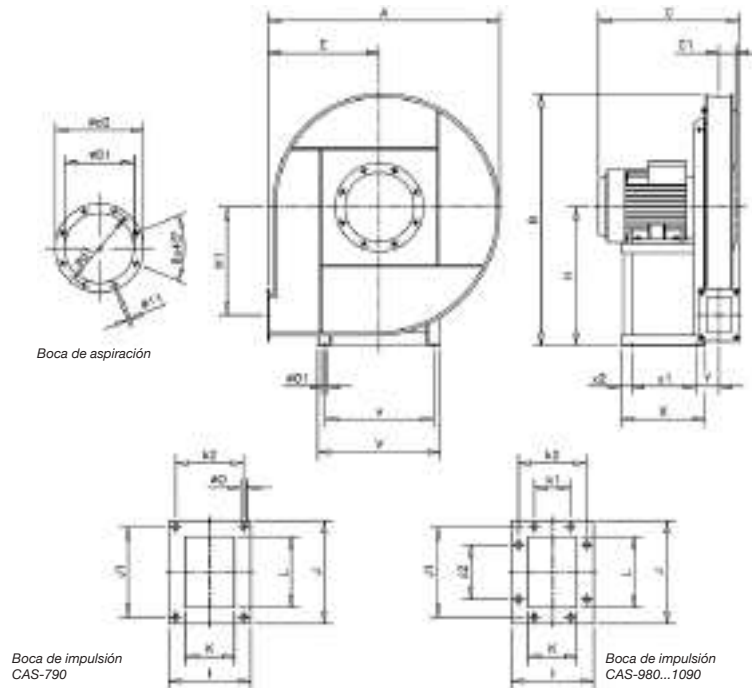

	A	B	C	C1	øD1	ød1	ød2	E	H	H1	I	J	J1	J2	K	k1	k2	L	øO	øO1	V	v	X	x1	x2	Y
CAS-790-2T-20	1095	1175	680	56	185	219	255	530	630	520	140	172	140	-	80	-	112	112	9	14	440	400	425	340	30	103
CAS-980-2T-30	1120	1250	740	90	255	292	325	530	710	530	210	270	241	112	140	112	182	200	11,5	14	500	450	470	370	35	143
CAS-990-2T-50	1270	1410	840	100	286	332	366	600	800	600	230	294	265	112	160	112	200	224	11,5	16	570	510	500	385	40	165
CAS-1080-2T-40	1120	1250	815	90	255	292	325	530	710	530	210	270	241	112	140	112	182	200	11,5	16	570	510	500	385	40	153
CAS-1090-2T-60	1270	1410	920	100	286	332	366	600	800	600	230	294	265	112	160	112	200	224	11,5	19	626	565	550	425	40	175

Dimensiones mm

CAS-S-242...971

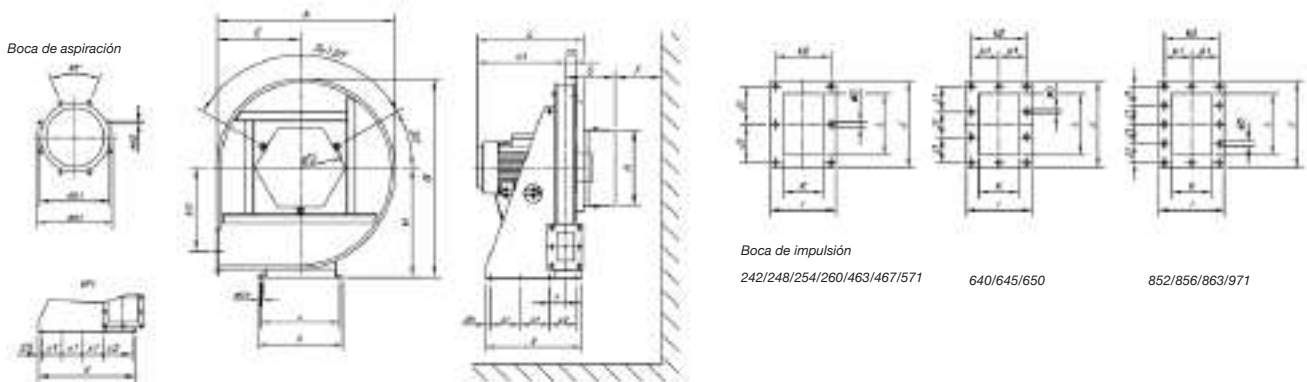

	A	B	C	C1	C2	øD1	ød1	ød2	ØD	N	S	F	E	H	H1	I
CAS-S-242-2T-0'33	576	662	299	236	33	100	130	M8	276	255	170	150	270	375	270	120
CAS-S-242-2T-0'5	576	662	319	256	33	100	130	M8	276	255	170	150	270	375	270	120
CAS-S-248-2T-1'1'5	639	728	343	277	36	112	140	M8	276	255	218	150	300	410	297	126
CAS-S-254-2T-2	699	788	413	342,5	40,5	125	155	M8	276	255	225	150	330	440	322	135
CAS-S-254-2T-3	699	788	413	342,5	40,5	125	155	M8	276	255	225	150	330	440	322	135
CAS-S-260-2T-3	782	875	419	343	46	150	175	M8	371	350	230	150	370	485	362	145
CAS-S-463-2T-5'5	782	875	459	383,5	45,5	200	240	M8	371	350	230	150	370	485	362	145
CAS-S-463-2T-7'5	782	875	517	441,5	45,5	200	240	M8	371	350	230	150	370	485	362	145
CAS-S-467-2T-7'5/10	833	945	524	436	48	224	258	M8	371	350	235	150	390	530	395	150
CAS-S-571-2T-10	873	995	536	445,5	50,5	250	275	M8	371	350	240	150	410	560	410	155
CAS-S-571-2T-15	873	995	693	602,5	50,5	250	275	M8	371	350	240	150	410	560	410	155
CAS-S-640-2T-2	639	728	446	350,5	65,5	250	275	M8	371	350	255	150	300	410	250	185
CAS-S-645-2T-3	699	788	461	358	73	250	275	M8	581	560	260	200	330	440	267,5	200
CAS-S-645-2T-4	699	788	503	400	73	250	275	M8	581	560	260	200	330	440	267,5	200
CAS-S-650-2T-5'5	782	875	534	421	83	250	275	M8	661	560	270	200	370	485	300	220
CAS-S-650-2T-7'5	782	875	572	459	83	250	275	M8	661	560	270	200	370	485	300	220
CAS-S-852-2T-7'5/10	833	945	603	468,5	94,5	280	310	M8	661	560	280	200	390	530	320	240
CAS-S-856-2T-15	833	945	730	597	93	355	395	M8	683	655	280	200	390	530	320	240
CAS-S-863-2T-15/20	873	995	728	585	103	355	410	M8	758	655	290	200	410	560	325	260
CAS-S-971-2T-30	1012	1170	881	720	116	400	450	M10	759	655	305	200	460	670	420	294
CAS-S-971-2T-40	1012	1170	948	787	116	400	450	M10	759	655	305	200	460	670	420	294

	J	J1	K	k1	k2	L	øO	øO1	V	v	X	x1	x2	Y
CAS-S-242-2T-0'33	155	65	60	-	95	95	11	12	305	275	260	75	-	61
CAS-S-242-2T-0'5	155	65	60	-	95	95	11	12	305	275	260	75	-	61
CAS-S-248-2T-1'1'5	165	70	66	-	101	105	11	12	320	290	300	90	-	64
CAS-S-254-2T-2	175	75	75	-	110	115	11	14	340	310	330	100	-	68,5
CAS-S-254-2T-3	175	75	75	-	110	115	11	14	340	310	330	100	-	68,5
CAS-S-260-2T-3	185	80	85	-	120	125	11	14	380	350	370	115	-	73,5
CAS-S-463-2T-5'5	185	80	85	-	120	125	11	14	380	350	370	115	-	73,5
CAS-S-463-2T-7'5	185	80	85	-	120	125	11	14	380	350	370	115	-	73,5
CAS-S-467-2T-7'5/10	190	82,5	90	-	125	130	11	14	405	375	300	125	-	76
CAS-S-571-2T-10	205	90	95	-	130	145	11	14	430	400	350	150	-	79,5
CAS-S-571-2T-15	205	90	95	-	130	145	11	14	430	400	410	180	-	79,5
CAS-S-640-2T-2	260	78	125	80	160	200	11	14	340	310	350	100	-	93,5
CAS-S-645-2T-3	284	86	140	87,5	175	224	11	14	380	350	380	115	-	101
CAS-S-645-2T-4	284	86	140	87,5	175	224	11	14	380	350	380	115	-	101
CAS-S-650-2T-5'5	310	95	160	97,5	195	250	11	14	405	375	490	125	190	111
CAS-S-650-2T-7'5	310	95	160	97,5	195	250	11	14	405	375	490	125	190	111
CAS-S-852-2T-7'5/10	340	78	180	107,5	215	280	11	14	430	400	540	150	190	122
CAS-S-856-2T-15	340	78	180	107,5	215	280	11	14	430	400	600	180	190	122
CAS-S-863-2T-15/20	375	87,5	200	117,5	235	315	11	14	430	400	620	180	210	132
CAS-S-971-2T-30	425	100	224	132	264	355	11	14	550	510	715	150	215	145
CAS-S-971-2T-40	425	100	224	132	264	355	11	14	550	510	715	150	215	145

SMALL SERIES

Dimensiones mm

CAS-S-790...1090

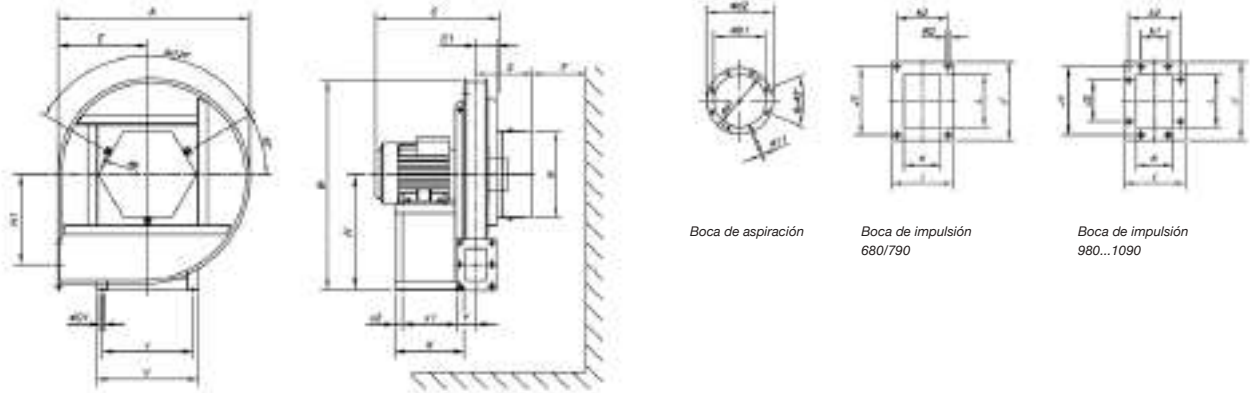

	A	B	C	C1	øD1	ød1	ød2	ØD	N	S	F	E	H	H1	I
CAS-S-790-2T-20	1095	1175	680	56	185	219	255	371	350	259	200	530	630	520	140
CAS-S-980-2T-30	1120	1250	740	90	255	292	325	581	560	290	200	530	710	530	210
CAS-S-990-2T-50	1270	1410	840	100	286	332	366	581	560	300	200	600	800	600	230
CAS-S-1080-2T-40	1120	1250	815	90	255	292	325	581	560	290	200	530	710	530	210
CAS-S-1090-2T-60	1270	1410	920	100	286	332	366	581	560	300	200	600	800	600	230
	J	J1	J2	K	k1	k2	L	øO	øO1	V	v	X	x1	x2	Y
CAS-S-790-2T-20	172	140	-	80	-	112	112	9	14	440	400	425	340	30	103
CAS-S-980-2T-30	270	241	112	140	112	182	200	11,5	14	500	450	470	370	35	143
CAS-S-990-2T-50	294	265	112	160	112	200	224	11,5	16	570	510	500	385	40	165
CAS-S-1080-2T-40	270	241	112	140	112	182	200	11,5	16	570	510	500	385	40	153
CAS-S-1090-2T-60	294	265	112	160	112	200	224	11,5	19	626	565	550	425	40	175

Curvas Características

Q= Caudal en m³/h, m³/s y cfm

Pe= Presión estática en mmH₂O, Pa e inwg

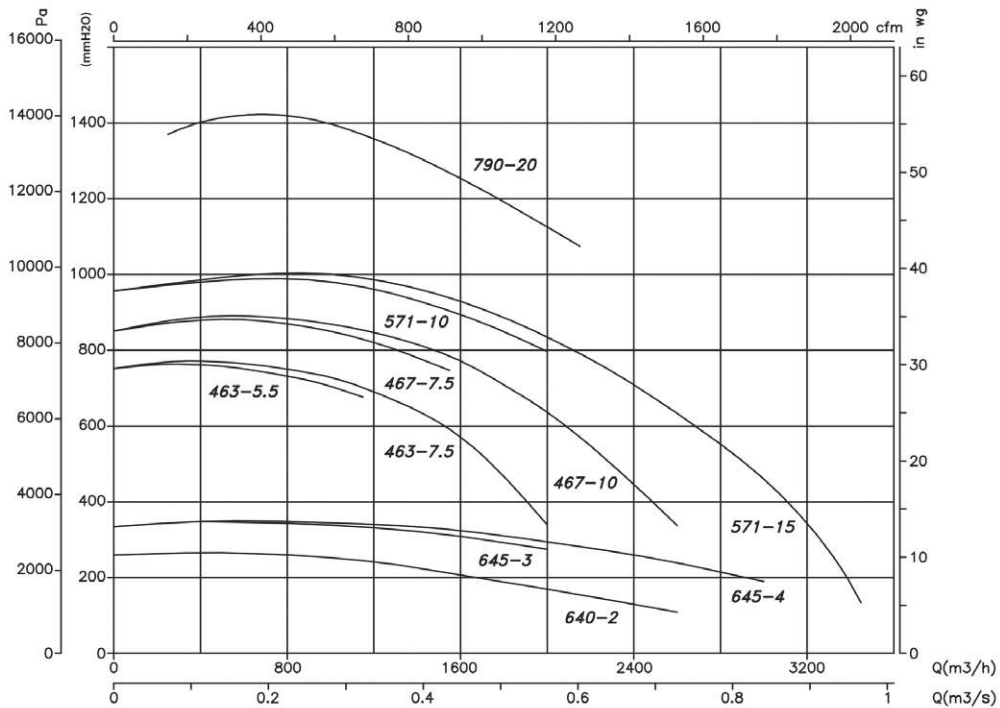
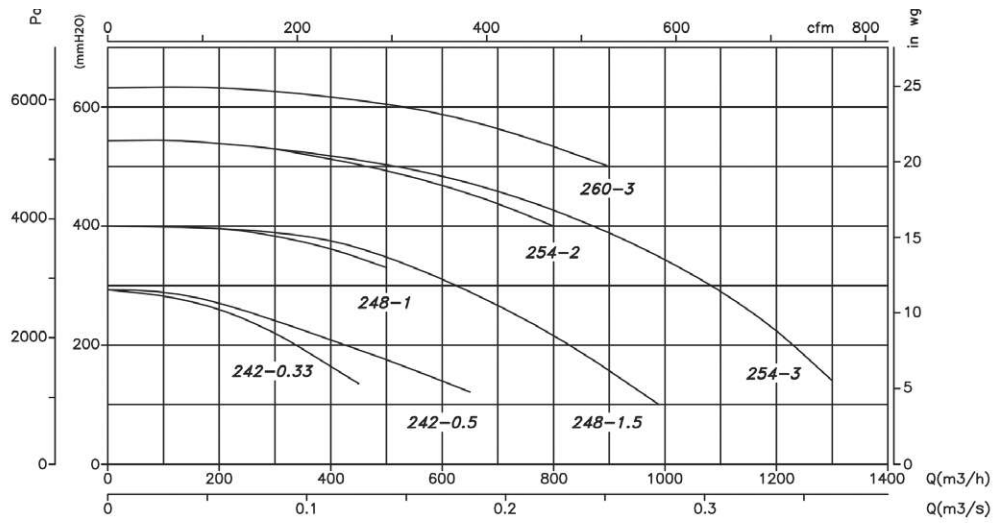

SMALL SERIES

Accesorios



INT

C2V

RM

VSD3/A-RFT

AET

RPA

B

BIC

ACE

CJACUS

S

REG

Curvas Características

Q= Caudal en m³/h, m³/s y cfm

Pe= Presión estática en mmH₂O, Pa e inwg

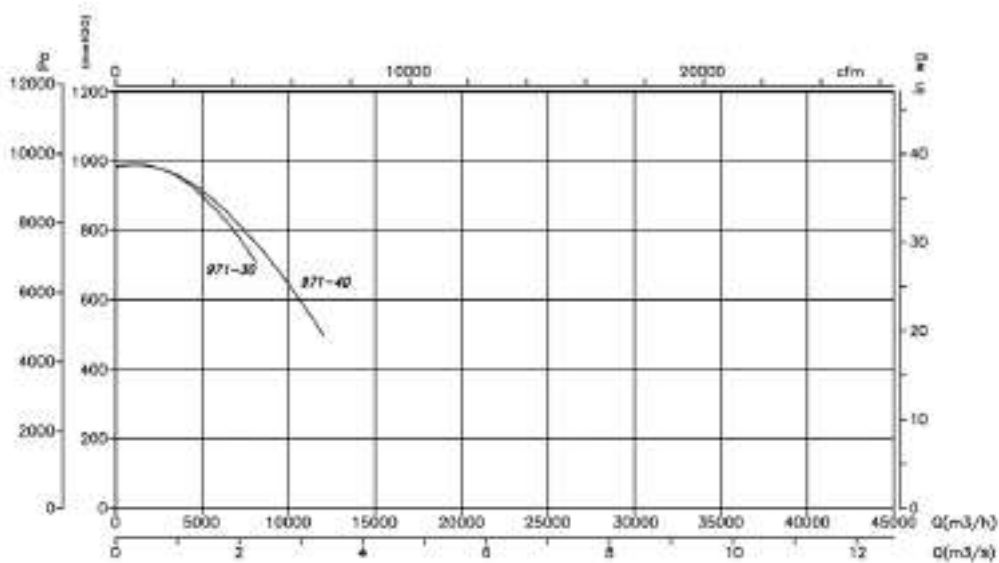
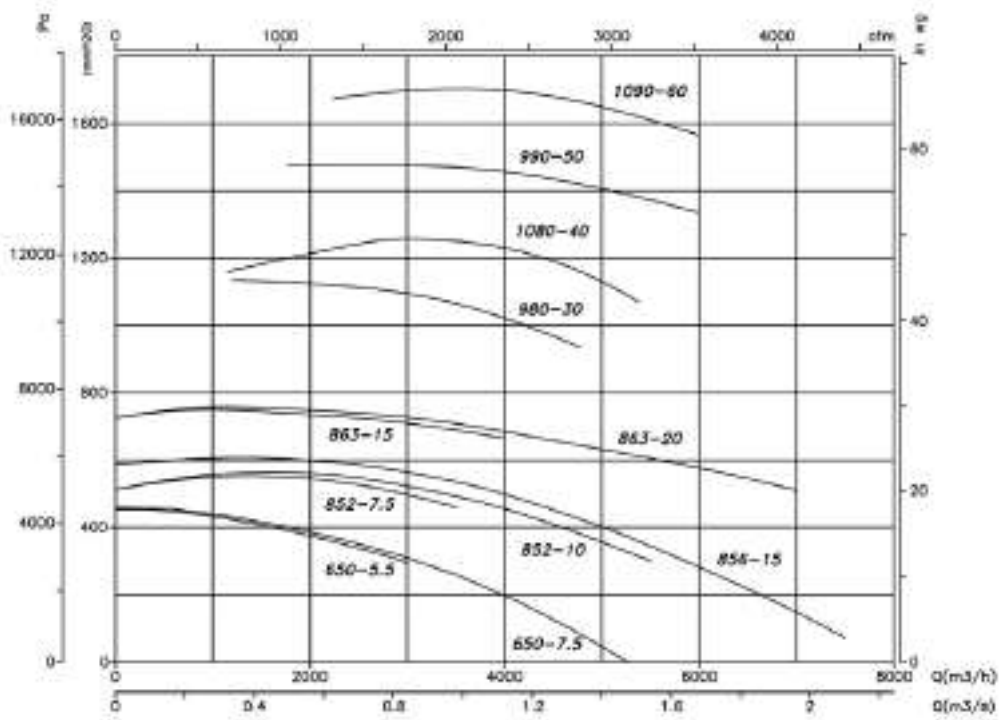

Orientaciones

Suministro standard LG 270
Posiciones LG 180 bajo demanda
y con medidas de anclaje especiales.

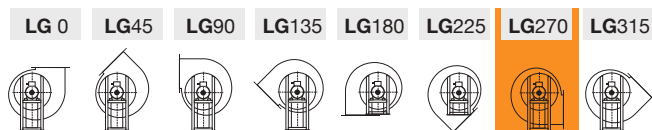

Suministro bajo demanda
Posiciones RD 180 con medidas
de anclaje especiales.

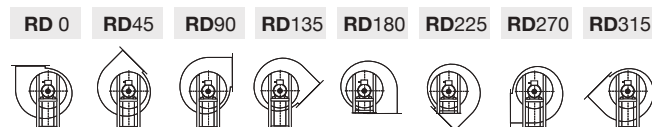

CAM



Ventiladores centrífugos de alta presión y simple aspiración con envolvente en chapa de acero y turbina en fundición de aluminio



Ventilador:

- Envolvente en chapa de acero.
- Turbina en fundición de aluminio y en chapa de acero los modelos 752, 880 y 980.

Motor:

- Motores con eficiencia IE3 para potencias iguales o superiores a 0,75 kW, excepto monofásicos, 2 velocidades y 8 polos.
- Motores clase F con rodamientos a bolas. Protección IP55.
- Trifásicos 230/400 V 50 Hz (hasta 4 kW) y 400/690 V 50 Hz (potencias superiores a 4 kW).
- Temperatura máxima del aire a transportar: -20 °C +120 °C.

Acabado:

- Anticorrosivo en resina de poliéster polimerizada a 190 °C, previo desengrase con tratamiento nanotecnológico libre de fosfatos.

Bajo demanda:

- Bobinados especiales para diferentes tensiones.
- Ventilador preparado para transportar aire hasta +250 °C.
- Ventilador en acero inoxidable.
- Certificación ATEX Categoría 2.



Turbinas de aluminio de alto rendimiento

Código de pedido

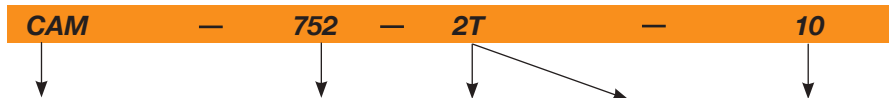

CAM: Ventiladores centrífugos de alta presión y simple aspiración con envolvente en chapa de acero y turbina en fundición de aluminio

Tamaño turbina

Número de polos motor
2=2900 r/min 50 Hz

T=Trifásico

Potencia motor (CV)

Características técnicas

Modelo	Velocidad (r/min)	Intensidad máxima admisible (A)			Potencia instalada (kW)	Caudal máximo (m³/h)	Nivel presión sonora dB(A)	Peso aprox. (Kg)	According ErP
		230V	400V	690V					
CAM-540-2T IE3	2875	5,34	3,07		1,50	2430	85	42	2015
CAM-545-2T-3 IE3	2910	7,32	4,21		2,20	2300	86	59	2015
CAM-545-2T-4 IE3	2910	10,00	5,77		3,00	3610	88	68	2015
CAM-550-2T-5.5 IE3	2900	13,00	7,50		4,00	2800	90	122	2015
CAM-550-2T-7.5 IE3	2930		10,10	5,86	5,50	5000	91	152	2015
CAM-752-2T-7.5 IE3	2930		10,10	5,86	5,50	2950	93	161	2015
CAM-752-2T-10 IE3	2930		14,10	8,17	7,50	5000	94	139	2015
CAM-760-2T-10 IE3	2930		14,10	8,17	7,50	2900	95	164	2015
CAM-760-2T-15 IE3	2945		20,00	11,60	11,00	5000	97	228	2015
CAM-760-2T-15/E IE3	2945		20,00	11,60	11,00	6380	98	226	2015
CAM-880-2T-40 IE3	2960		54,50	31,60	30,00	10000	99	420	2015
CAM-980-2T-60 IE3	2960		77,50	44,90	45,00	11390	92	580	Excluded



Erp. (Energy Related Products)

Información de la Directiva 2009/125/EC descargable desde la web de SODECA o programa de selección QuickFan

Características acústicas

Espectro de potencia sonora Lw(A) en dB(A) por banda de frecuencia en Hz.

	63	125	250	500	1000	2000	4000	8000		63	125	250	500	1000	2000	4000	8000
540	57	70	81	90	97	91	86	78	752-10	67	81	92	101	108	102	96	89
545-3	58	71	82	91	98	92	87	79	760-10	70	83	95	103	110	105	99	91
545-4	60	73	84	93	100	94	89	81	760-15	72	85	97	105	112	107	101	93
550-5.5	63	77	88	97	104	98	92	85	760-15/E	73	86	98	106	113	108	102	94
550-7.5	64	78	89	98	105	99	93	86	880	75	89	100	109	116	110	104	97
752-7.5	66	80	91	100	107	101	95	88	980	86	88	96	100	107	104	99	91

Dimensiones mm

CAM-540...545

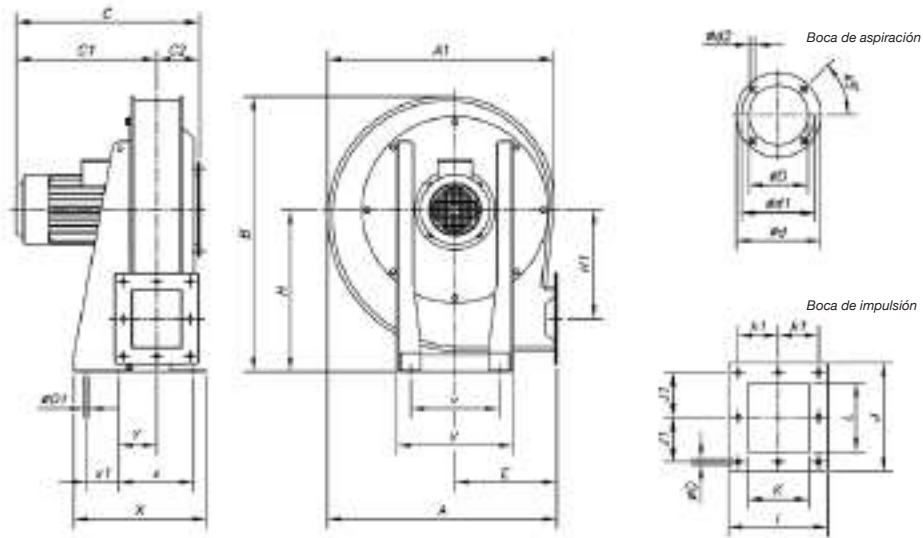

	A	A1	B	C	C1	C2	øD	øD	øD1	øD2	E	H	H1	I	J	J1	K	k1	L	øO	øO1	V	v	X	x	x1	Y
CAM-540-2T	568	562	681	454	348	106	170	235	205	11	252	400	270	206	224	92	120	83	140	10	12	288	218	328	186	80	94
CAM-545-2T-3	654	644	772	474	355,5	118,5	165	235	205	11	290	450	310	222	255	108	135	90	170	10	12	300	238	344	202	80	102,5
CAM-545-2T-4	654	644	772	504	385,5	115,5	165	235	205	11	290	450	310	222	255	108	135	90	170	10	12	300	238	344	202	80	102,5

CAM-550...880

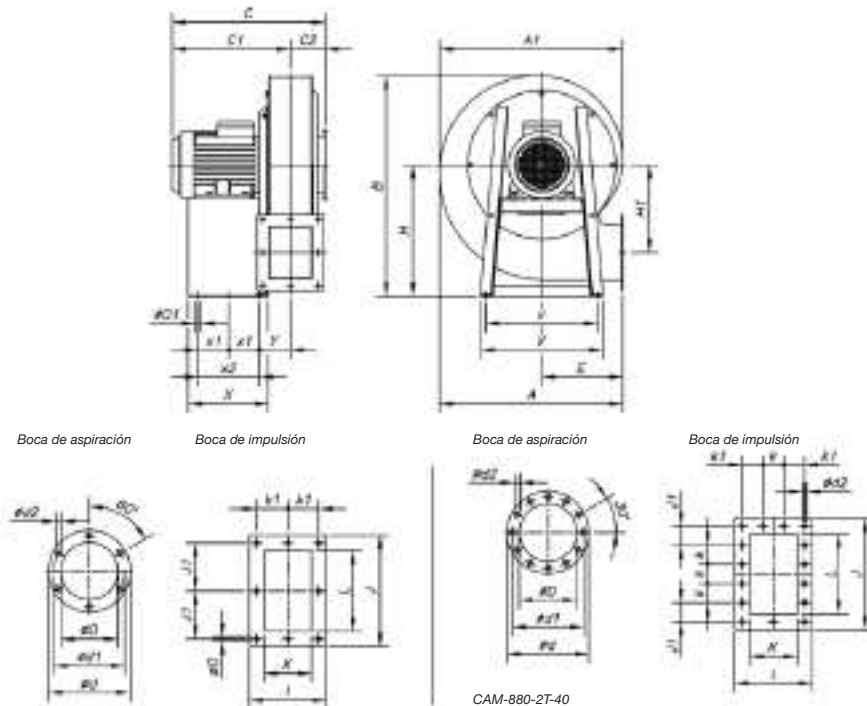

	A	A1	B	C	C1	C2	øD	øD	øD1	øD2	E	H	H1	I	J	J1	K	k	k1	L	øO	øO1	V	v	X	x1	x2	Y
CAM-550-2T-5'5	719	715	868	552	416	136	210	278	258	9	311	510	350	246	296	128	150	-	103	200	11	13	475	435	279	210	210	115,5
CAM-550-2T-7'5	719	715	868	590	454	136	210	278	258	9	311	510	350	246	296	128	150	-	103	200	11	13	475	435	310	210	210	115,5
CAM-752-2T-7'5	713	713	856	594	459	135	217	278	258	9	315	510	340	256	296	128	160	-	108	200	11	13	475	435	390	210	210	121
CAM-752-2T-10	713	713	856	594	459	135	217	278	258	9	315	510	340	256	296	128	160	-	108	200	11	13	475	435	390	210	210	121
CAM-760-2T-10	837,5	833,5	975	616	462	147	212	322	280	9,5	370	570	380	276	316	138	180	-	118	220	11	13	570	525	450	202,5	405	74,5
CAM-760-2T-15	837,5	833,5	975	736	589,5	147	212	322	280	9,5	370	570	380	276	316	138	180	-	118	220	11	13	570	525	450	202,5	405	74,5
CAM-760-2T-15/E	837,5	833,5	975	736	589,5	147	212	322	280	9,5	370	570	380	276	316	138	180	-	118	220	11	13	570	525	450	202,5	405	74,5
CAM-880-2T-40	945	939	1167	905	771	134	290	390	355	10	422	710	430	249	360	61	190	71	76	290	11	13	565	523	480	210	420	133

Dimensiones mm

CAM-980

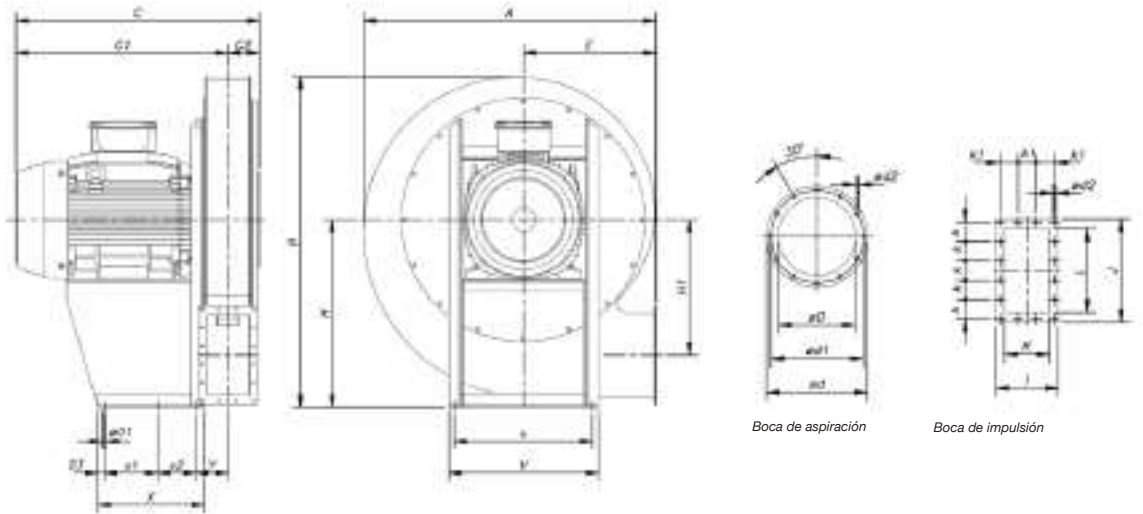

	A	B	C	C1	C2	øD	ød	ød1	ød2	E	H	H1	I	J	K	k	k1	L	ø01	V	v	X	x1	x2	Y
CAM-980-2T-60	1104	1243	918,5	798,5	120	276	360	330	10	500	750	510	221	370	162	69	65	300	13	565	523	400	202	145	120

Orientaciones

Suministro standard LG 270
 Posiciones LG 180 bajo demanda y con medidas de anclaje especiales.

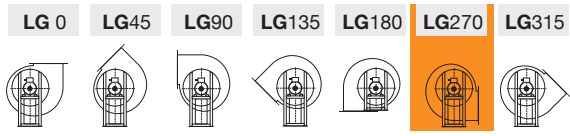

Curvas Características

Q= Caudal en m³/h, m³/s y cfm Pe= Presión estática en mmH₂O, Pa e inwg

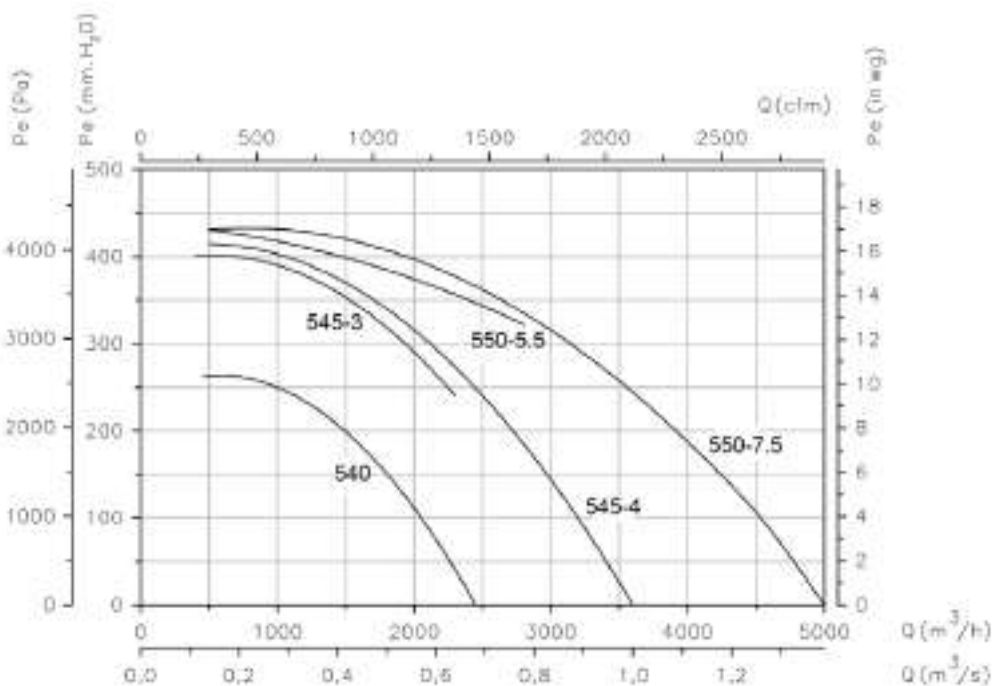

SMALL SERIES

Curvas Características

Q= Caudal en m³/h, m³/s y cfm

Pe= Presión estática en mmH₂O, Pa e inwg

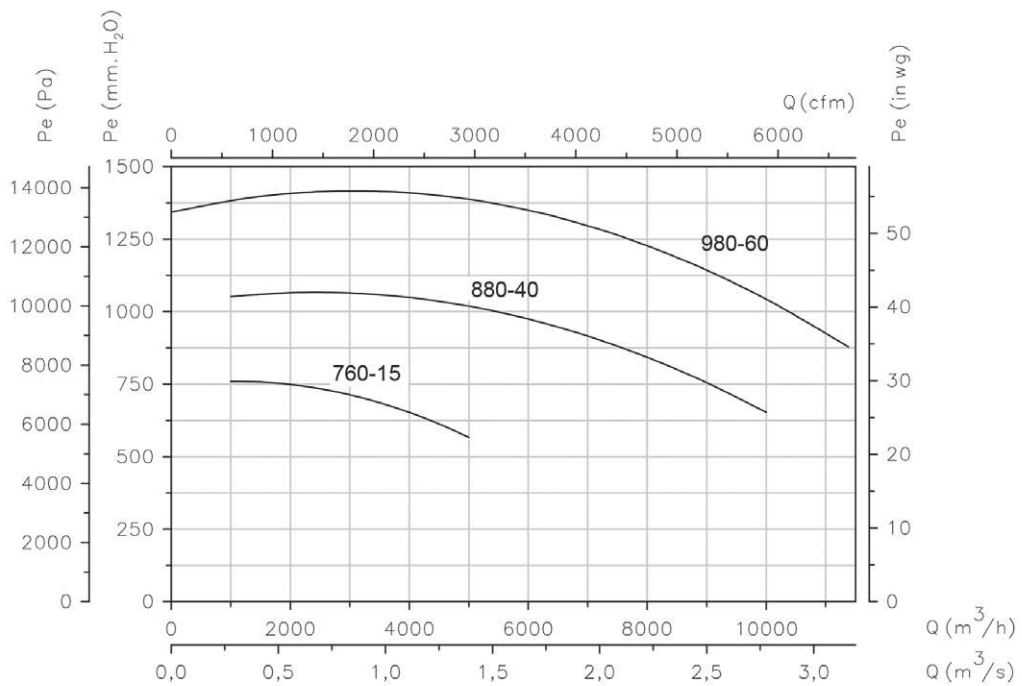
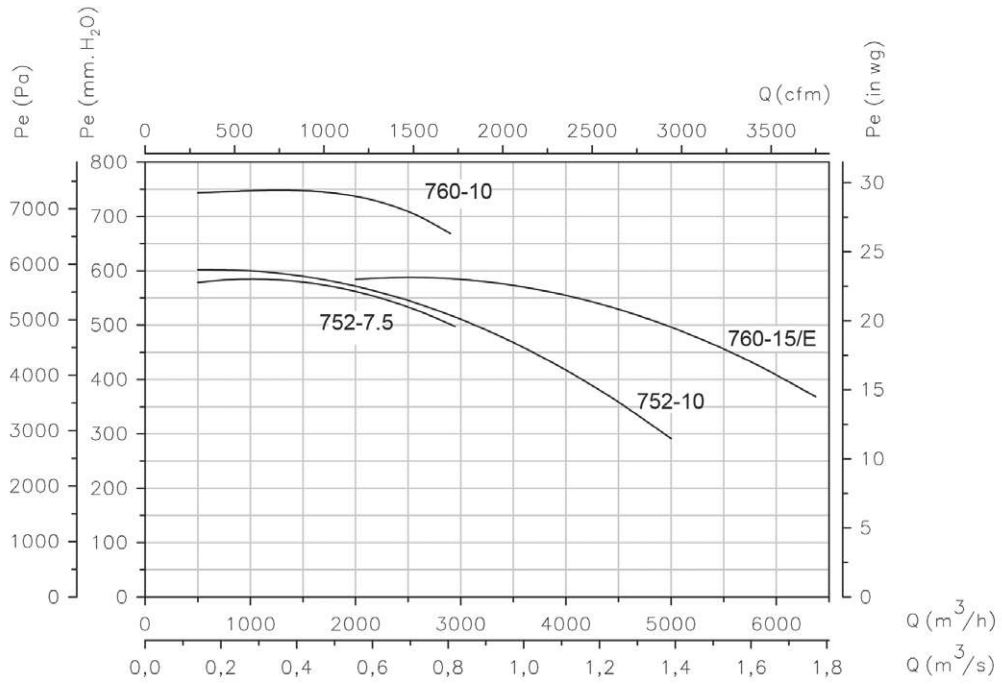

Accesorios



INT

C2V

RM

VSD3/A-RFT

AET

RPA

B

BIC

ACE

CJACUS

S

REG

CMTS



Ventiladores centrífugos de media presión y simple aspiración con envoltorio y turbina de pala recta en chapa de acero, para transporte de humo con material sólido



Ventilador:

- Envoltorio en chapa de acero.
- Turbina de pala recta en chapa de acero.

Motor:

- Motores con eficiencia IE3 para potencias iguales o superiores a 0,75 kW, excepto monofásicos, 2 velocidades y 8 polos.
- Motores clase F con rodamientos a bolas. Protección IP55.
- Trifásicos 230/400 V 50 Hz (hasta 4 kW) y 400/690 V 50 Hz (potencias superiores a 4 kW).
- Temperatura máxima del aire a transportar: -20 °C +120 °C.

Acabado:

- Anticorrosivo en resina de poliéster polimerizada a 190 °C, previo desengrase con tratamiento nanotecnológico libre de fosfatos.

Bajo demanda:

- Bobinados especiales para diferentes tensiones.
- Ventilador preparado para transportar aire hasta +250 °C.
- Certificación ATEX Categoría 2.

Código de pedido

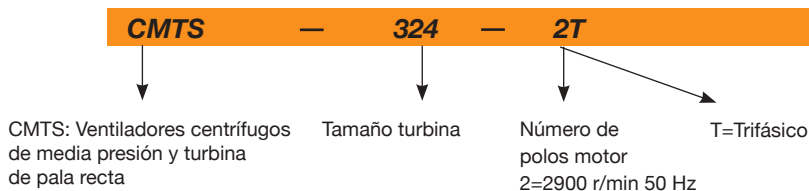

Características técnicas

Modelo	Velocidad (r/min)	Intensidad máxima admisible (A)		Potencia instalada (kW)	Caudal máximo (m³/h)	Nivel presión sonora dB(A)	Peso aprox. (Kg)
		230V	400V				
CMTS-512-2T/R	2710	1,00	0,58	0,08	338	62	4
CMTS-512-2M/R	2780	1,33		0,08	338	62	4
CMTS-514-2T/R	2710	1,00	0,58	0,18	537	65	5
CMTS-514-2M/R	2780	1,33		0,18	537	65	5
CMTS-616-2T/R	2760	2,57	1,49	0,55	802	69	8
CMTS-616-2M/R	2810	3,49		0,55	802	69	10
CMTS-718-2T/R IE3	2825	2,80	1,62	0,75	1144	70	18
CMTS-718-2M/R	2810	4,62		0,75	1144	70	13
CMTS-820-2T/R IE3	2830	4,03	2,34	1,10	1569	73	16
CMTS-820-2M/R	2820	6,51		1,10	1569	73	16

SMALL SERIES

Dimensiones mm

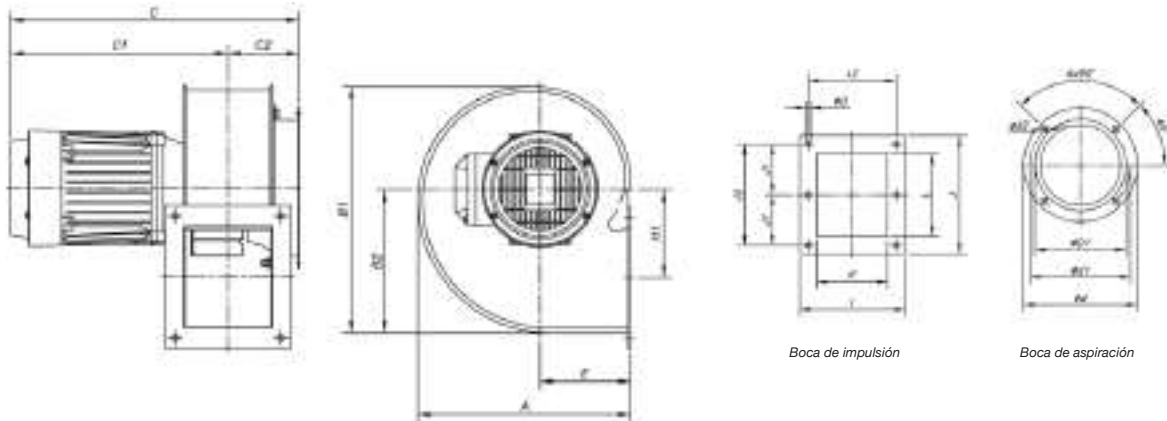

	A	B1	B2	C	C1	C2	øD1*	ød	ød1	ød2	E	H1	I	J	J1	J2	K	k2	L	øO
CMTS-512/R	185	206,5	118	295	215	79,5	112	140	132	M4	82,5	69	104	117	-	104,5	75	92	86	5,5
CMTS-514/R	225	254	150	305	220	85	140	169	151,5	M4	100	91	122	147	64	128	83	105	107	6,5
CMTS-616/R	258	297	173,5	377,5	290	87,5	160	204	180	M6	110	105,5	153	172	-	147	103	128	125	7
CMTS-718-2T/R	303,5	348	201	410	310	100	180	238	210	M6	129,5	122	169	192	85	170	115	145	146	9
CMTS-718-2M/R	303,5	348	201	465	365	100	180	238	210	M6	129,5	122	169	192	85	170	115	145	146	9
CMTS-820/R	322	377	223	420	315	105	200	247	230	M6	137,5	137	184	213	94,5	189	130	160	156	9

* Diámetro nominal tubería recomendado

Curvas Características

Q= Caudal en m³/h, m³/s y cfm

Pe= Presión estática en mmH₂O, Pa e inwg

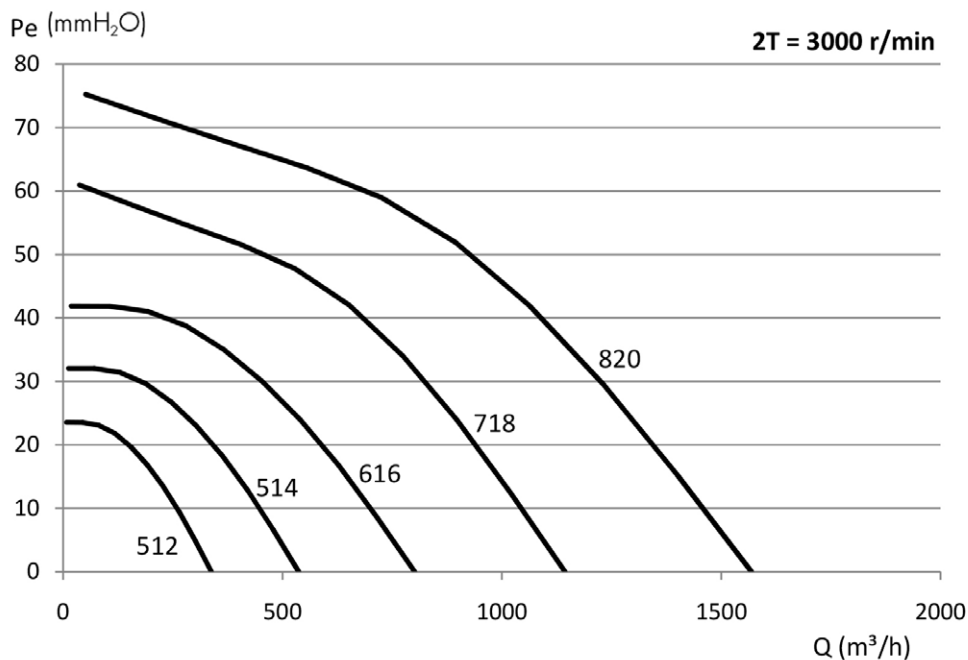

Orientaciones

Suministro standard LG 270



CMT



Ventiladores centrífugos de media presión y simple aspiración con envolvente y turbina de pala recta en chapa de acero, para transporte de polvo y material sólido



Ventilador:

- Envolvente en chapa de acero.
- Turbina de pala recta en chapa de acero.

Motor:

- Motores con eficiencia IE3 para potencias iguales o superiores a 0,75 kW, excepto monofásicos, 2 velocidades y 8 polos.
- Motores clase F con rodamientos a bolas. Protección IP55.
- Trifásicos 230/400 V 50 Hz (hasta 4 kW) y 400/690 V 50 Hz (potencias superiores a 4 kW).
- Temperatura máxima del aire a transportar: -20 °C +120 °C.

Acabado:

- Anticorrosivo en resina de poliéster polimerizada a 190 °C, previo desengrase con tratamiento nanotecnológico libre de fosfatos.

Bajo demanda:

- Bobinados especiales para diferentes tensiones.
- Ventilador preparado para transportar aire hasta +250 °C.
- Certificación ATEX Categoría 2.



Turbina radial de alta robustez

Código de pedido

CMT — 1435 — 2T — 10

CMT: Ventiladores centrífugos de media presión y turbina de pala recta en chapa de acero, para transporte de polvo y material sólido

Tamaño turbina

Número de polos motor
2=2900 r/min 50 Hz
4=1400 r/min 50 Hz

T=Trifásico

Potencia motor (CV)

Características técnicas

Modelo	Velocidad (r/min)	Intensidad máxima admisible (A)			Potencia instalada (kW)	Caudal máximo (m³/h)	Nivel presión sonora dB(A)	Peso aprox. (Kg)
		230V	400V	690V				
CMT-922-2T IE3	2830	4,03	2,34		1,1	2180	71	23
CMT-1025-2T IE3	2875	5,34	3,07		1,5	2850	74	35
CMT-1128-2T IE3	2910	7,32	4,21		2,2	4500	76	42
CMT-1231-2T-4 IE3	2910	10,00	5,77		3	5220	78	57
CMT-1231-2T-5.5 IE3	2900	13,00	7,50		4	6300	79	79
CMT-1435-2T-7.5 IE3	2930		10,10	5,86	5,5	7800	85	109
CMT-1435-2T-10 IE3	2930		14,10	8,17	7,5	8260	87	91
CMT-1640-2T-10 IE3	2930		14,10	8,17	7,5	9600	90	101
CMT-1845-2T-15 IE3	2945		20,00	11,60	11	10500	91	215
CMT-1845-2T-20 IE3	2945		27,70	16,10	15	13000	94	218

SMALL SERIES

Características acústicas

Espectro de potencia sonora Lw(A) en dB(A) por banda de frecuencia en Hz.

	63	125	250	500	1000	2000	4000	8000		63	125	250	500	1000	2000	4000	8000
922-2	45	61	76	76	77	74	72	63	1435-2-7,5	62	77	93	92	94	90	88	80
1025-2	48	64	79	79	80	77	75	66	1435-2-10	64	79	95	94	96	92	90	82
1128-2	50	66	81	81	82	79	77	68	1640-2-10	67	82	98	97	99	95	93	85
1231-2-4	55	70	86	85	87	83	81	73	1845-2-15	70	85	100	100	101	98	96	87
1231-2-5,5	56	71	87	86	88	84	82	74	1845-2-20	73	88	103	103	104	101	99	90

Dimensiones mm

CMT-922...1231

Boca de aspiración

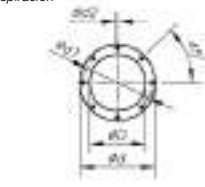

Boca de impulsión

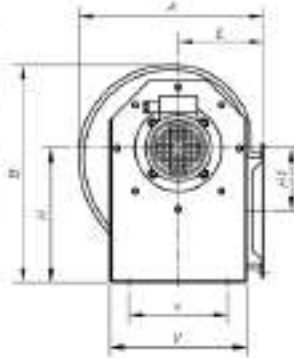
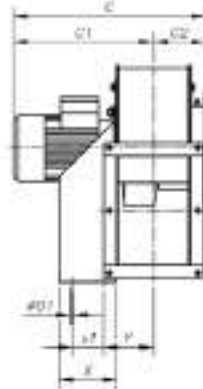

	A	B	C	C1	C2	øD	ød	ød1	ød2	E	H	H1	I	J	J1	K	k2	L	øO	øO1	V	v	X	x1	Y
CMT-922	388,5	455	416	309	107	170	244	210	9,5	180	280	134	204	282,5	128	140	180	215	9,5	10,5	290	220	114	50	105
CMT-1025-2T	427	503	490	369,5	120,5	190	264	230	9,5	197	310	144	229	312,5	145	165	205	250	9,5	12,5	315	228	134	74	115,5
CMT-1128-2T	472	553	505	377	128	210	284	249	9,5	216	340	152	244	364	170	180	220	296,5	9,5	12,5	348	245	144	95	122,5
CMT-1231-2T-4	526	630	555	417	138	240	305	275	9,5	238	390	179,5	264	382,5	180	200	240	320	11,5	13	382	322	183	140	125
CMT-1231-2T-5,5	526	630	578	440	138	240	305	275	9,5	238	390	179,5	264	382,5	180	200	240	320	11,5	13	382	322	183	140	125

CMT-1435...2050

Boca de aspiración



Boca de impulsión

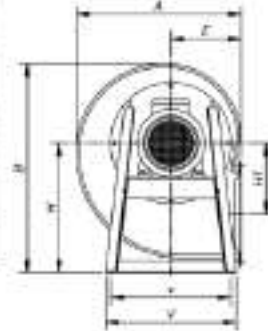
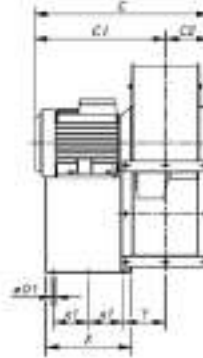
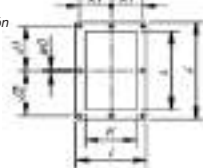

	A	B	C	C1	C2	øD	ød	ød1	ød2	E	H	H1	I	J	J1	K	k1	L	øO	øO1	V	v	X	x1	Y
CMT-1435-2T	573,5	715	661	504	157	276	344	310	9,5	250	445	242,5	292	342,5	159	228	133	280	11,5	12	456	420	333	136,5	149
CMT-1640-2T	634	799	673	504	169	276	344	310	9,5	270	495	271	336	404	185	250	150	321	11,5	12	500	460	327	133,5	161
CMT-1845-2T-15	711	901	817	626	191	350	434	395	9,5	302	560	305	370	444	202	284	164	361	11,5	12	538	502	420	180	178
CMT-1845-2T-20	711	901	817	626	191	350	434	395	9,5	302	560	305	370	444	202	284	164	361	11,5	12	538	502	420	180	178

Curvas Características

Q= Caudal en m³/h, m³/s y cfm

Pe= Presión estática en mmH₂O, Pa e inwg

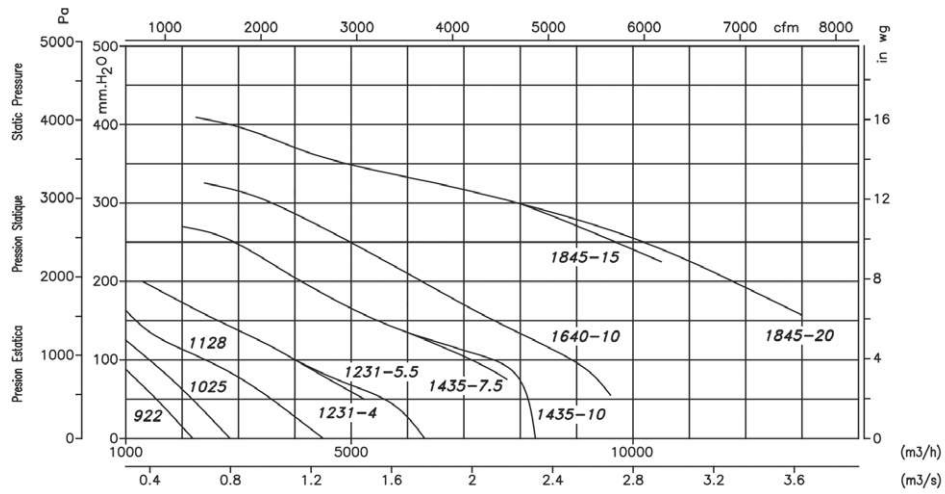

Orientaciones

Suministro standard LG 270

Posición LG 180 y RD 180 bajo demanda y con medidas de anclaje especiales.



Accesorios



SMALL SERIES

CMAT



Ventiladores centrífugos de media presión y simple aspiración con envolvente y turbina de pala recta en fundición de aluminio, para transporte de polvo y material sólido



Ventilador:

- Envolvente en fundición de aluminio.
- Turbina de pala recta en fundición de aluminio modelos del 324 al 531 y en chapa de acero modelos del 540 al 545.

Motor:

- Motores con eficiencia IE3 para potencias iguales o superiores a 0,75 kW, excepto monofásicos, 2 velocidades y 8 polos.
- Motores clase F con rodamientos a bolas. Protección IP55.
- Trifásicos 230/400 V 50 Hz.
- Temperatura máxima del aire a transportar: -20 °C +120 °C.

Acabado:

- Anticorrosivo en resina de poliéster polimerizada a 190 °C, previo desengrase con tratamiento nanotecnológico libre de fosfatos.

Bajo demanda:

- Bobinados especiales para diferentes tensiones.
- Ventilador preparado para transportar aire hasta +250 °C.
- Certificación ATEX Categoría 2.



Posibilidad de diferentes posiciones de impulsión

Código de pedido

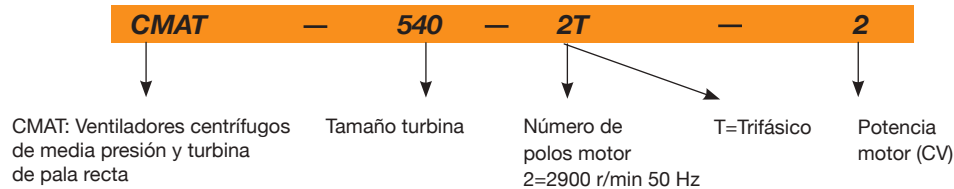

Características técnicas

Modelo	Velocidad (r/min)	Intensidad máxima admisible (A)		Potencia instalada (kW)	Caudal máximo (m³/h)	Nivel presión sonora dB(A)	Peso aprox. (Kg)
		230V	400V				
CMAT-324-2T	2750	1,21	0,70	0,18	300	70	9
CMAT-325-2T	2710	1,29	0,75	0,25	450	73	11
CMAT-426-2T	2710	1,92	1,11	0,37	650	75	12
CMAT-527-2T	2710	1,92	1,11	0,37	900	80	13
CMAT-528-2T IE3	2825	2,80	1,62	0,75	1400	80	25
CMAT-531-2T IE3	2830	4,03	2,34	1,10	1800	84	25
CMAT-540-2T-2 IE3	2875	5,34	3,07	1,50	2080	80	42
CMAT-540-2T-3 IE3	2910	7,32	4,21	2,20	2800	82	46
CMAT-545-2T-4 IE3	2910	10,00	5,77	3,00	3115	80	60

Características acústicas

Espectro de potencia sonora Lw(A) en dB(A) por banda de frecuencia en Hz.

	63	125	250	500	1000	2000	4000	8000		63	125	250	500	1000	2000	4000	8000
324	42	48	72	79	76	69	60	52	531	51	67	90	92	89	83	77	69
325	47	54	76	80	80	75	65	56	540-2	55	76	91	86	87	83	76	68
426	42	54	78	85	77	71	63	58	540-3	57	81	89	88	92	89	83	75
527	47	61	84	90	82	75	67	61	545	62	81	87	86	87	89	82	74
528	49	64	89	85	84	79	72	65									

Dimensiones mm

CMAT-324...528

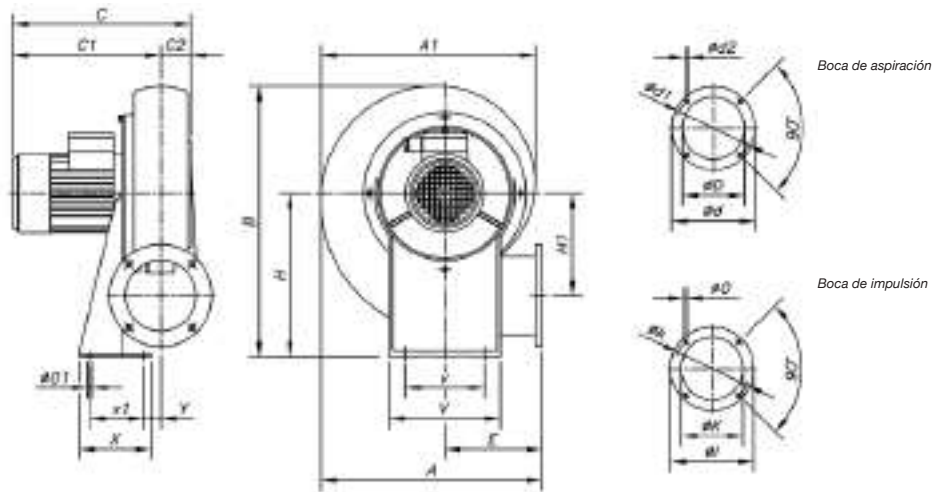

	A	A1	B	C	C1	C2	øD	ød	ød1	ød2	E	H	H1	øl	øK	øk	øO	øO1	V	v	X	x1	Y
CMAT-324	311	302	356	264	226	38	80	130	112	M5	145	205	145	108	62	90	7	9	173	125	90	60	20
CMAT-325	335	328	399	284	244	40	94	140	122	M6	155	235	152	120	80	102	7	9	180	145	110	80	20
CMAT-426	354	344	412	290	250	40	117	155	132	M6	162	240	163	140	90	119	7	13	210	160	105	65	22
CMAT-527	371	361	440	295	253	42	125	170	147	M6	168	260	170	155	100	129	7	13	220	170	120	80	17
CMAT-528	401	395	485	337	289	48	135	190	162	M6	178	288	177	190	130	160	11	13	230	180	140	100	20

CMAT-531

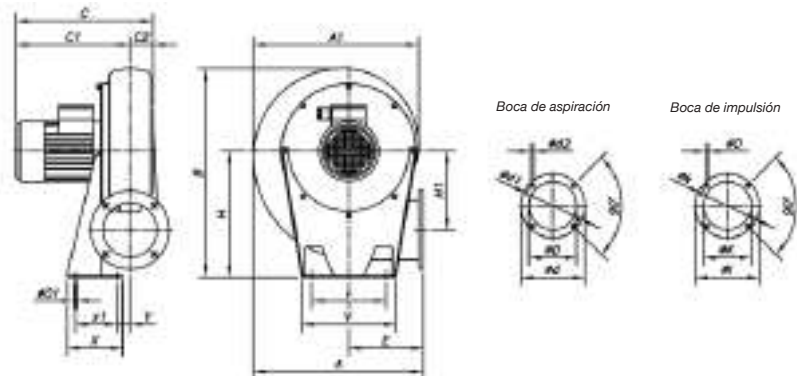

	A	A1	B	C	C1	C2	øD	ød	ød1	ød2	E	H	H1	øl	øK	øk	øO	øO1	V	v	X	x1	Y
CMAT-531	432	420	530	339	289	50	160	215	180	M6	189	320	200	200	140	175	11	13	226	190	160	120	19

CMAT-540...545

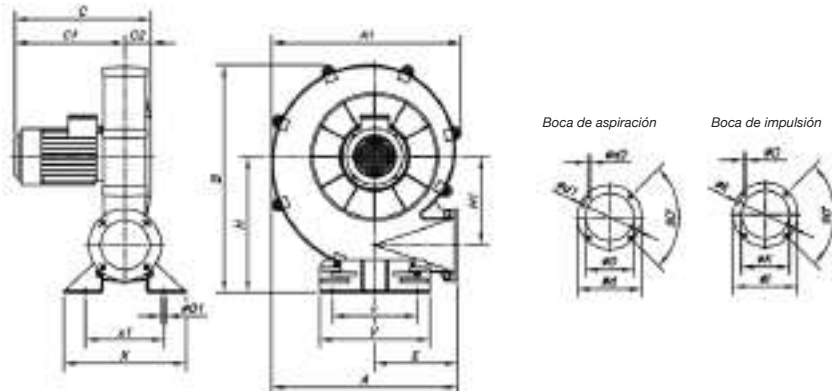

	A	A1	B	C	C1	C2	øD	ød	ød1	ød2	E	H	H1	øl	øK	øk	øO	øO1	V	v	X	x1
CMAT-540	562	550	690	403	323	80	170	240	205	M10	252	415	270	220	150	190	13	11	336	218	376	242
CMAT-545	651	646	776	483	368	115	180	255	220	M10	290	450	309	250	175	220	13	13	336	238	392	292

Curvas Características

Q= Caudal en m³/h, m³/s y cfm

Pe= Presión estática en mmH₂O, Pa e inwg

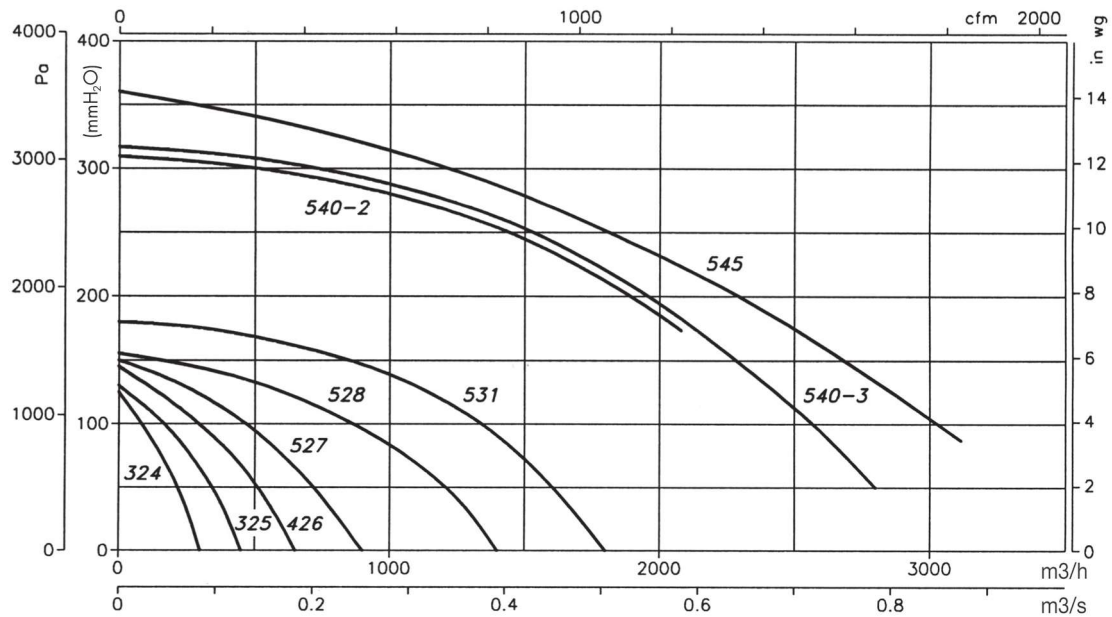

Orientaciones

Suministro standard LG 270
 Posición LG 180 bajo demanda de anclaje especiales.

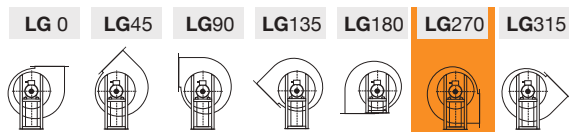

Accesorios



PORT



Extractores de aire portátiles de gran potencia y robustez



Ventilador:

- Extractor portátil de gran potencia de aspiración.
- Para la extracción de aire sucio y polvoriento, en instalaciones donde se requiera la extracción de una forma intermitente y móvil, especialmente diseñado para aplicaciones industriales y agrícolas.

Características constructivas:

- Envolvente en chapa de acero de gran espesor.
- Turbina a reacción de gran robustez.
- Bancada soporte con ruedas de larga durabilidad.
- Brida de impulsión circular incluida.
- Rejilla de protección en aspiración incluida.

Motor:

- Motores con eficiencia IE3 para potencias iguales o superiores a 0,75 kW, excepto monofásicos, 2 velocidades y 8 polos.
- Motores clase F con rodamientos a bolas.

Protección IP55.

- Trifásicos 230/400 V 50 Hz (hasta 4 kW) y 400/690 V 50 Hz (potencias superiores a 4 kW).
- Temperatura máxima del aire a transportar: -20 °C +120 °C.

Acabado:

- Anticorrosivo en resina de poliéster polimerizada a 190 °C, previo desengrase con tratamiento nanotecnológico libre de fosfatos.

Bajo demanda:

- Bobinados especiales para diferentes tensiones.
- Ventilador preparado para transportar aire hasta +250 °C.
- Ventilador en acero inoxidable.
- Certificación ATEX.

Características técnicas

Modelo	Velocidad (r/min)	Intensidad máxima admisible (A)			Potencia instalada (kW)	Caudal máximo (m³/h)	Nivel presión sonora dB(A)	Peso aprox. (Kg)	According ErP
		230V	400V	690V					
PORT-1135-2T-3 IE3	2910	7,32	4,21		2,20	7800	83	75	2015
PORT-1240-2T-5.5 IE3	2900	13,00	7,50		4,00	11100	86	114	2015
PORT-1445-2T-10 IE3	2930		14,10	8,17	7,50	16500	87	142	2015
PORT-1650-2T-15 IE3	2945		20,00	11,60	11,00	18850	89	230	2015
PORT-1650-2T-20 IE3	2945		27,70	16,10	15,00	19500	90	243	2015

Dimensiones mm

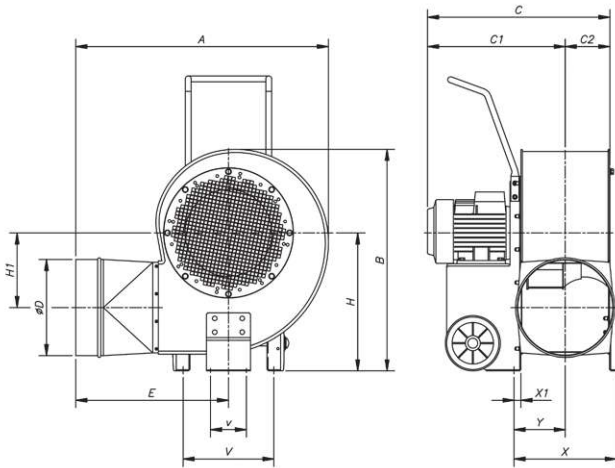

	A	B	C	C1	C2	øD	E	H	H1	øO	V	v	X	X1	Y
PORT-1135-2T-3	866	720	576,5	432	144,5	315	542	450	242,5	12	330	130	332	20	163
PORT-1240-2T-5'5	920	805	663	500,5	162,5	355	555	500	271	12	330	130	372	25	186
PORT-1445-2T-10	1050	918	745,5	562,5	183	400	635	575	271	12	370	130	411,5	25	205,5
PORT-1650-2T-15	1128	987	890,5	685	205,5	500	672	610	297	12	390	130	453	25	227
PORT-1650-2T-20	1128	987	890,5	685	205,5	500	672	610	297	12	390	130	453	25	227



Erp. (Energy Related Products)

Información de la Directiva 2009/125/EC descargable desde la web de SODECA o programa de selección QuickFan

Accesorios



B

Ventiladores centrífugos para aplicaciones industriales **LARGE SERIES**



MEDIA PRESIÓN



76

CMRS

Ventiladores centrífugos de media presión y simple aspiración, de gran robustez, equipados con turbina a reacción

Diseñados para aire limpio o ligeramente polvoriento



110

CAMA

Ventiladores centrífugos de media presión y simple aspiración de gran robustez con envolvente y turbina en chapa de acero

Diseñados para aire con polvo



144

CAMC

Ventiladores centrífugos de media presión y simple aspiración de gran robustez con envolvente y turbina en chapa de acero

Diseñados para aire con polvo



160

CAMD

Ventiladores centrífugos de media presión y simple aspiración de gran robustez con envolvente y turbina en chapa de acero

Diseñados para aire con polvo



ALTA PRESIÓN



190

CASB

Ventiladores centrífugos de alta presión y simple aspiración de gran robustez con envolvente y turbina en chapa de acero

Diseñados para aire con polvo



222

CAAB

Ventiladores centrífugos de alta presión y simple aspiración de gran robustez con envolvente y turbina en chapa de acero

Diseñados para aire limpio y polvoriento



240

CAAE

Ventiladores centrífugos de alta presión y simple aspiración de gran robustez con envolvente y turbina en chapa de acero

Diseñados para aire limpio y polvoriento



252

CAAF

Ventiladores centrífugos de alta presión y simple aspiración de gran robustez con envolvente y turbina en chapa de acero

Diseñados para aire limpio y polvoriento

TRANSPORTE



266

CAST

Ventiladores centrífugos de pala abierta y simple aspiración de gran robustez con envolvente y turbina en chapa de acero

Diseñados para aire con mucho polvo y materiales en suspensión



282

CMTB

Ventiladores centrífugos de pala abierta y simple aspiración de gran robustez con envolvente y turbina en chapa de acero

Diseñados para aire con mucho polvo y materiales en suspensión



294

CMTC

Ventiladores centrífugos de pala abierta y simple aspiración de gran robustez con envolvente y turbina en chapa de acero

Diseñados para aire con mucho polvo y materiales en suspensión

MOTOR DIRECTO

CMRS

Ventiladores centrífugos de media presión y simple aspiración, de gran robustez, equipados con turbina a reacción
Diseñados para aire limpio o ligeramente polvoriento



SISTEMA

4



Ventilador:

- Envoltente en chapa de acero.
- Turbina a reacción en chapa de acero de gran robustez, especialmente diseñados para aire limpio o ligeramente polvoriento.
- Motor directamente acoplado.
- Equipados con trampilla de inspección excepto modelos 350, 400, 450, 500 y 560.
- Con trampilla de inspección y limpieza a partir del tamaño 560.
- Los tamaños superiores a 1250, se suministran con carcasa partida para facilitar el transporte.
- Carcasa soldada en continuo a partir del tamaño 800.

Motor:

- Motores con eficiencia IE3 para potencias iguales o superiores a 0,75 kW, excepto monofásicos, 2 velocidades y 8 polos.
- Motores clase F con rodamientos a bolas. Protección IP55.
- Trifásicos 230/400 V 50 Hz (hasta 4 kW) y 400/690 V 50 Hz (potencias superiores a 4 kW).
- Temperatura máxima del aire a transportar: -25 °C +90 °C.

Acabado:

- Anticorrosivo en resina de poliéster polimerizada a 190 °C, previo desengrase con tratamiento nanotecnológico libre de fosfatos.

Bajo demanda:

- Bobinados especiales para diferentes tensiones.
- Ventilador preparado para transportar aire hasta +300 °C.
- Ejecuciones especiales para temperaturas +300 °C.
- Ventilador en acero inoxidable.
- Certificación ATEX Categoría 2.
- Acoplamiento elástico sistema 8.

* Las imágenes son solo a nivel ilustrativo, el producto puede variar en función del tamaño, especificaciones y posición.

Código de pedido



CMRS: Ventiladores centrífugos de media presión y simple aspiración, de gran robustez

Tamaño turbina

Número de polos motor
2=2900 r/min 50 Hz
4=1400 r/min 50 Hz
6=900 r/min 50 Hz

T=Trifásico

Potencia motor (CV)

Formas constructivas motor directo

SISTEMA

4

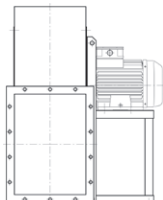

Accionamiento directo, turbina montada en el eje motor, montado sobre la silleta.

SISTEMA

5

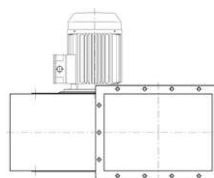

Accionamiento directo, turbina montada en el eje motor, motor de brida montado sobre la carcasa del ventilador.

SISTEMA

8

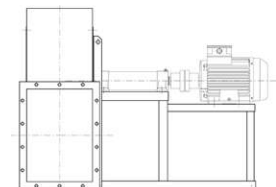

Accionamiento por acoplamiento elástico, turbina montada en el eje soporte, montado al motor mediante acoplamiento elástico. Todo montado conjuntamente sobre la silleta ventilador.

Orientaciones

RD 0 RD45 RD90 RD135 RD180 RD225 RD270 RD315 LG 0 LG45 LG90 LG135 LG180 LG225 LG270 LG315

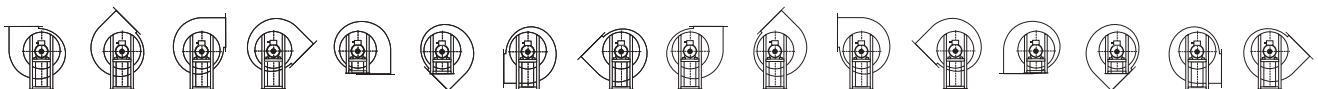

Suministro estándar LG270, otras posiciones bajo demanda. Modelos del 350 al 710 orientables. Medidas especiales en posiciones 180 y 225. Modelos del 800 al 900 orientables. Medidas especiales excepto posición 315. Modelos del 1000 al 1400 no orientables. Medidas especiales excepto posición 315.

Características técnicas

Modelo	Frame	Velocidad (r/min)	Intensidad máx admisible (A)			Potencia instalada (kW)	Caudal máximo (m3/h)	Nivel Presión Sonora dB(A)	Peso aprox (Kg)	According ErP
			230 V	400 V	690 V					
CMRS-350-2T-4 IE3	100 LA/2	2910	10,00	5,77		3,00	7750	77	81	2015
CMRS-350-4T-0.5	71 B/4	1380	1,84	1,06		0,37	3900	65	50	2015
CMRS-400-2T-5.5 IE3	112 M/2	2900	13,00	7,50		4,00	9700	79	101	2015
CMRS-400-2T-7.5 IE3	132 SA/2	2930		10,10	5,86	5,50	12100	82	130	2015
CMRS-400-4T-0.75	80 A/4	1420	2,28	1,31		0,55	5400	67	69	2015
CMRS-450-2T-10 IE3	132 SB/2	2935		13,90	8,06	7,50	13600	83	141	2015
CMRS-450-2T-15 IE3	160 MA/2	2945		20,00	11,60	11,00	17200	84	198	2015
CMRS-450-4T-1 IE3	80 B/4	1420	2,82	1,62		0,75	6850	69	79	2015
CMRS-450-4T-1.5 IE3	90 S/4	1455	4,07	2,34		1,10	7700	70	88	2015
CMRS-500-2T-20 IE3	160 MB/2	2945		27,70	16,10	15,00	19400	88	231	2015
CMRS-500-2T-25 IE3	160 L/2	2945		33,90	19,70	18,50	24300	89	250	2015
CMRS-500-4T-2 IE3	90 L/4	1440	5,41	3,11		1,50	9750	71	125	2015
CMRS-500-4T-3 IE3	100 LA/4	1435	7,93	4,56		2,20	10850	72	130	2015
CMRS-500-6T-0.75	80 B/6	910	2,59	1,49		0,55	6900	61	107	2015
CMRS-560-4T-4 IE3	100 LB/4	1440	10,70	6,15		3,00	13600	73	153	2015
CMRS-560-4T-5.5 IE3	112 M/4	1450	13,90	8,00		4,00	17300	73	162	2015
CMRS-560-6T-1 IE3	90 S/6	940	3,36	1,93		0,75	8650	62	132	2015
CMRS-560-6T-1.5 IE3	90 L/6	945	4,68	2,69		1,10	9650	65	141	2015
CMRS-630-4T-7.5 IE3	132 S/4	1465		10,30	5,97	5,50	19100	75	216	2015
CMRS-630-4T-10 IE3	132 MA/4	1465		13,90	8,06	7,50	24600	75	227	2015
CMRS-630-6T-2 IE3	100 LA/6	950	6,43	3,70		1,50	12200	66	171	2015
CMRS-630-6T-3 IE3	112 M/6	950	9,08	5,22		2,20	15350	68	181	2015
CMRS-710-4T-15 IE3	160 M/4	1470		20,90	12,10	11,00	27550	78	352	2015
CMRS-710-4T-20 IE3	160 L/4	1465		27,90	16,20	15,00	34900	78	377	2015
CMRS-710-6T-4 IE3	132 SA/6	970	12,00	6,91		3,00	17200	70	276	2015
CMRS-710-6T-5.5 IE3	132 MA/6	960	15,60	8,99		4,00	21700	71	285	2015
CMRS-800-4T-25 IE3	180 M/4	1470		35,10	20,30	18,50	38250	81	480	2015
CMRS-800-4T-30 IE3	180 L/4	1470		41,00	23,80	22,00	48250	83	503	2015
CMRS-800-6T-7.5 IE3	132 M/6	970		11,20	6,49	5,50	24400	74	359	2015
CMRS-800-6T-10 IE3	160 M/6	975		14,80	8,58	7,50	30900	74	412	2015
CMRS-900-4T-50 IE3	225 S/4	1480		66,80	38,70	37,00	54300	85	810	2015
CMRS-900-4T-60 IE3	225 L/4	1475		80,90	46,90	45,00	69550	85	849	2015
CMRS-900-6T-15 IE3	160 L/6	975		21,90	12,70	11,00	34650	76	521	2015
CMRS-900-6T-20 IE3	180 L/6	975		28,20	16,30	15,00	42600	76	583	2015
CMRS-1000-4T-75 IE3	250 M/4	1480		98,60	57,20	55,00	76650	87	1082	2015
CMRS-1000-4T-100 IE3	280 S/4	1485		134,00	77,70	75,00	96150	88	1319	2015
CMRS-1000-6T-25 IE3	200 LR/6	980		35,90	20,80	18,50	48750	77	783	2015
CMRS-1000-6T-30 IE3	200 L/6	980		42,40	24,60	22,00	61800	78	810	2015
CMRS-1120-6T-40 IE3	225 M/6	985		55,40	32,10	30,00	71500	80	1081	2015
CMRS-1120-6T-50 IE3	250 M/6	985		67,20	39,00	37,00	85950	80	1261	2015
CMRS-1250-6T-75 IE3	280 M/6	985		103,00	59,70	55,00	98300	83	1618	2015
CMRS-1250-6T-100 IE3	315 S/6	990		139,00	80,60	75,00	121200	84	1947	2015
CMRS-1400-6T-125 IE3	315 M/6	990		165,00	95,70	90,00	142150	87	2328	2015
CMRS-1400-6T-150 IE3	315 M/6	990		201,00	117,00	110,00	173400	88	2476	2015



Erp. (Energy Related Products)

Información de la Directiva 2009/125/EC descargable desde la web de SODECA o programa de selección QuickFan

Curvas Características

Q= Caudal en m³/h, m³/s y cfm

Pe= Presión estática en mmH₂O, Pa e inwg

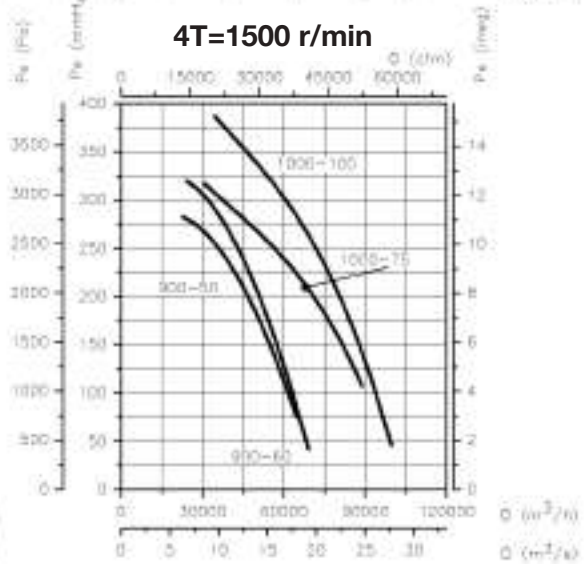
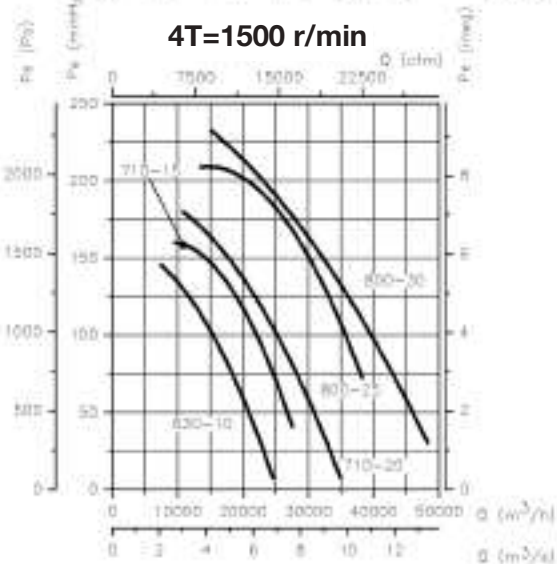
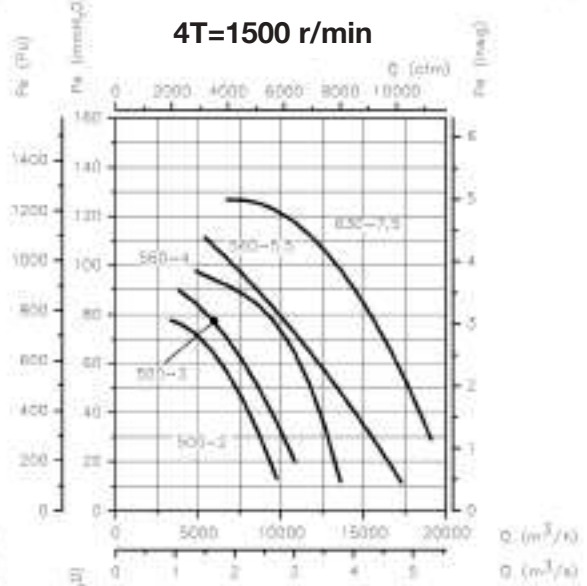
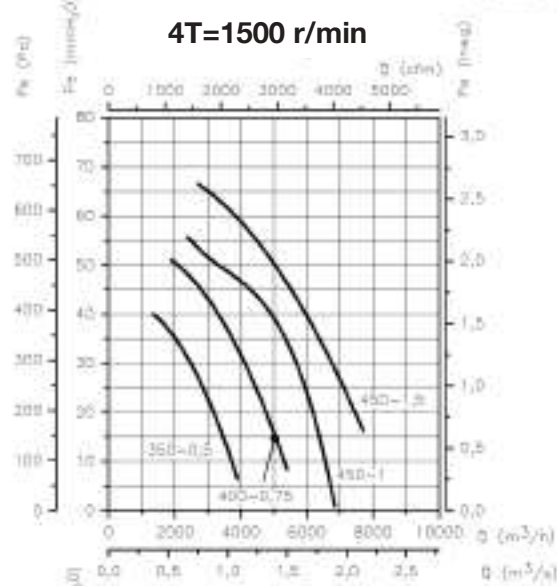
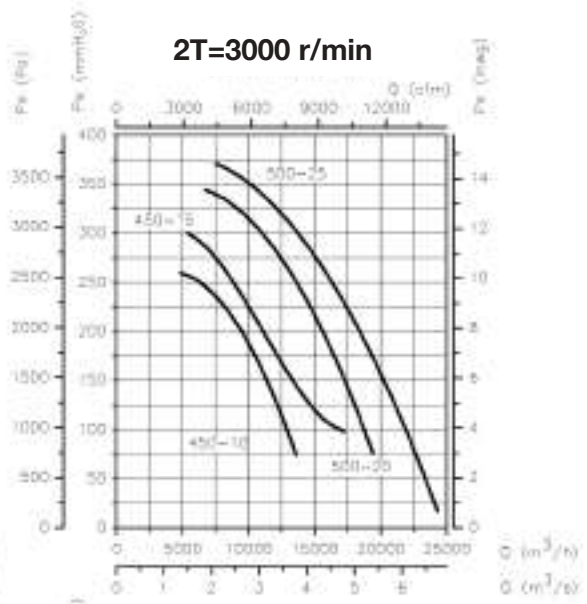
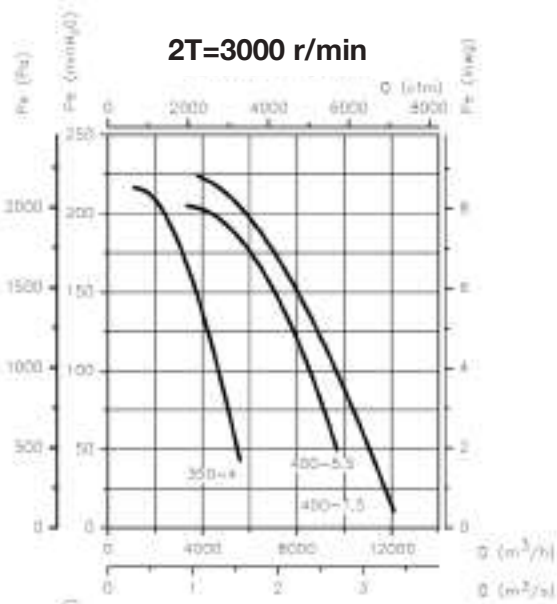

LARGE SERIES

Curvas Características

Q= Caudal en m³/h, m³/s y cfm

Pe= Presión estática en mmH₂O, Pa e inwg

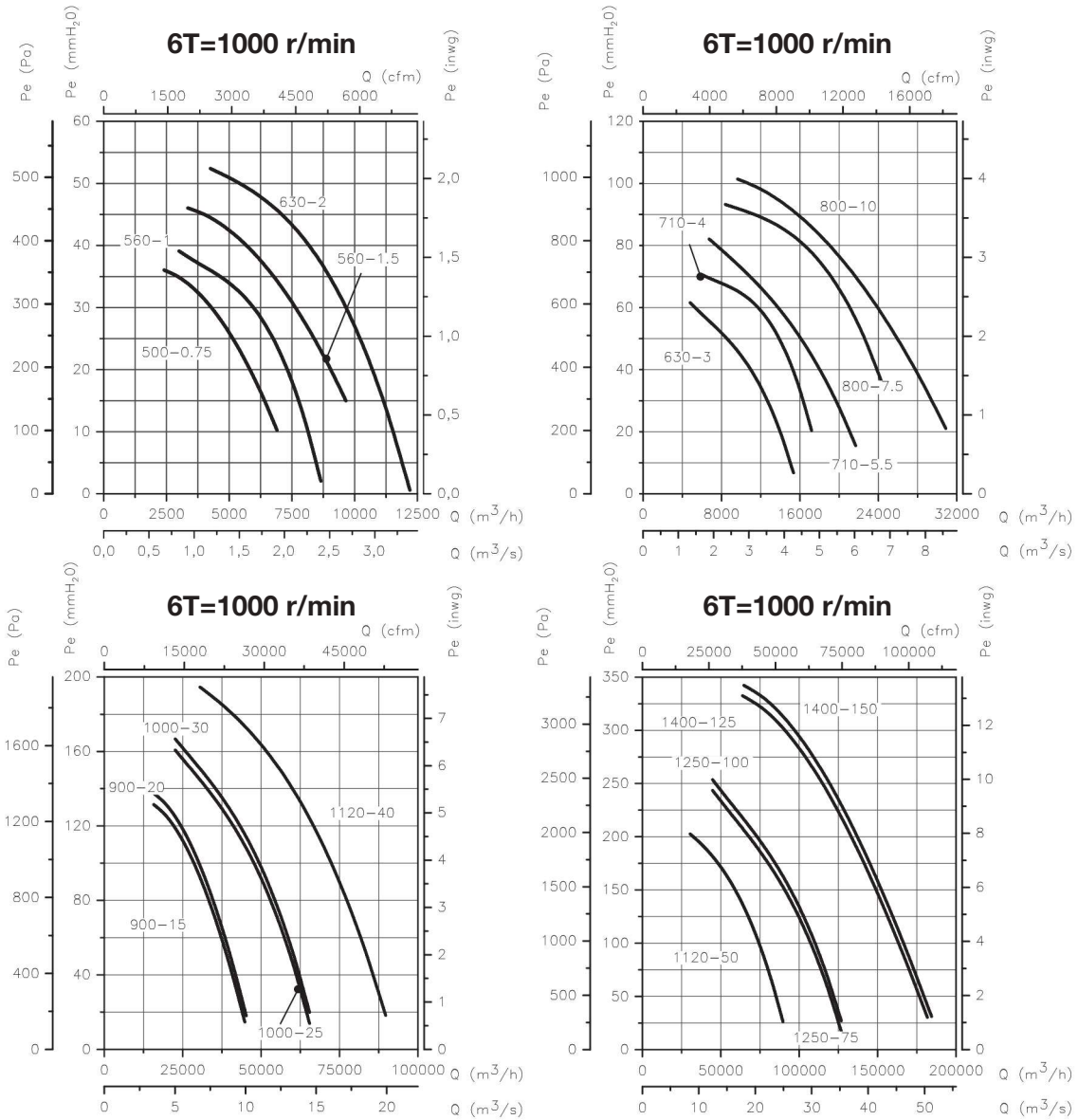

Accesorios



INT C2V RM VSD3/A-RFT VSD1/A-RFM AET RPA B BD BIC ACE S REG



Drall-Regler Válvula lamas contrapuestas

MOTOR A TRANSMISIÓN

CMRS-X

Ventiladores accionados a transmisión, equipados con motor eléctrico, conjunto de poleas, correas y protectores normalizados según norma ISO-13857
 Diseñados para aire limpio o ligeramente polvoriento



- Los tamaños superiores a 1600, se suministran con carcasa partida para facilitar el transporte.
- Carcasa soldada en continuo a partir del tamaño 800.

Motor:

- Motores con eficiencia IE3.
- Motores clase F con rodamientos a bolas. Protección IP55.
- Trifásicos 230/400 V 50 Hz (hasta 4 kW) y 400/690 V 50 Hz (potencias superiores a 4 kW).
- Temperatura máxima del aire a transportar: -25 °C +90 °C.

Acabado:

- Anticorrosivo en resina de poliéster polimerizada a 190 °C, previo desengrase con tratamiento nanotecnológico libre de fosfatos.

Bajo demanda:

- Bobinados especiales para diferentes tensiones.
- Ventilador preparado para transportar aire hasta +300 °C.
- Ventilador en acero inoxidable.
- Certificación ATEX Categoría 2.
- Acoplamiento elástico sistema 8.

Ventilador:

- Envoltente en chapa de acero.
- Turbina a reacción en chapa de acero de gran robustez, especialmente diseñados para aire limpio o ligeramente polvoriento.
- Motor montado sobre bancada general.
- Ventilador accionado a transmisión.
- Equipados con trampilla de inspección excepto modelos 350, 400, 450, 500 y 560.
- Con trampilla de inspección y limpieza a partir del tamaño 560.

* Las imágenes son solo a nivel ilustrativo, el producto puede variar en función del tamaño, especificaciones y posición.

Formas constructivas motor a transmisión

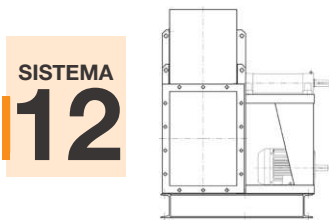

Accionamiento a transmisión, igual al SISTEMA 1, con el motor y ventilador montados en la bancada común. Posiciones de motor "W" o "Z" y excepcionalmente "X" o "Y".

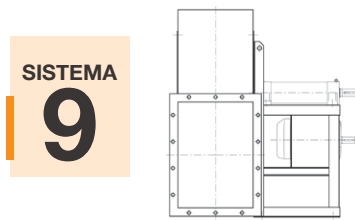

Accionamiento a transmisión, igual al SISTEMA 1, con el motor montado en el lateral de la silleta, en posición "W" o "Z".

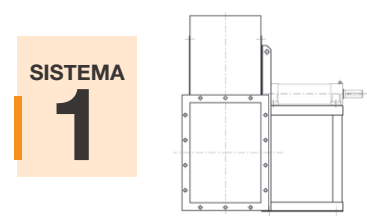

Accionamiento a transmisión, turbina montada en el eje soporte. Soporte montado sobre la silleta.

LARGE SERIES

Orientaciones

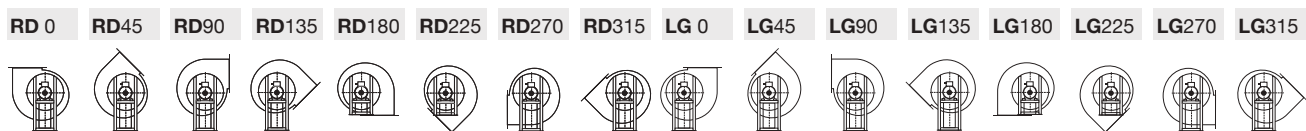

Curvas Características

CMRS-X 250

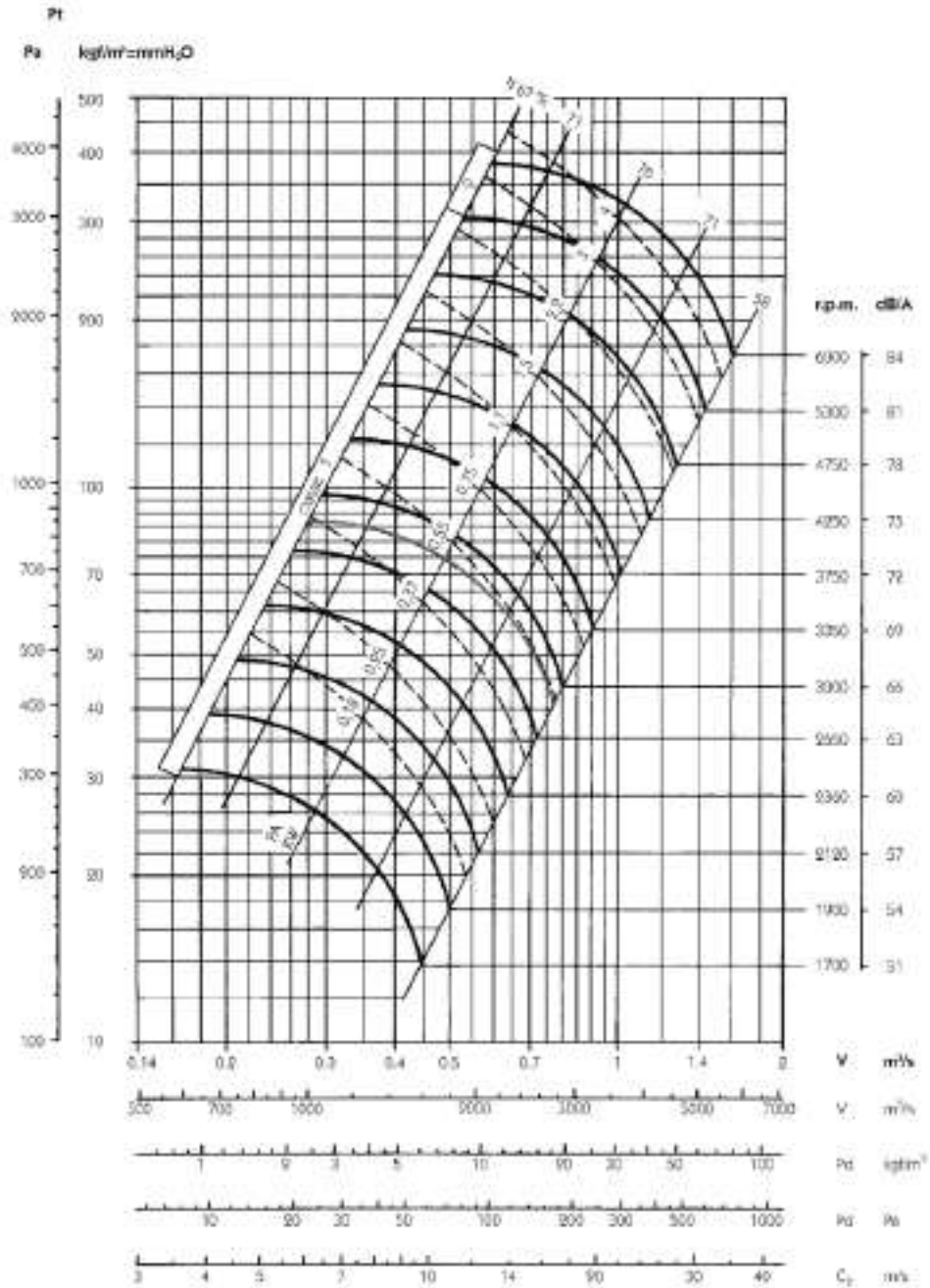

Margen sobre el caudal $\pm 5\%$.
 Margen del nivel sonoro +3 ... 5 dB.
 Margen kW absorbidos $\pm 3\%$.

Características en impulsión.

Rpm máximas admisibles

	Clase 1	Clase 2
$\leq 100^{\circ}\text{C}$	5000	6300
100 ... 200 $^{\circ}\text{C}$	4500	5600
200 ... 300 $^{\circ}\text{C}$	4000	5000

LARGE SERIES

Curvas Características

CMRS-X 280

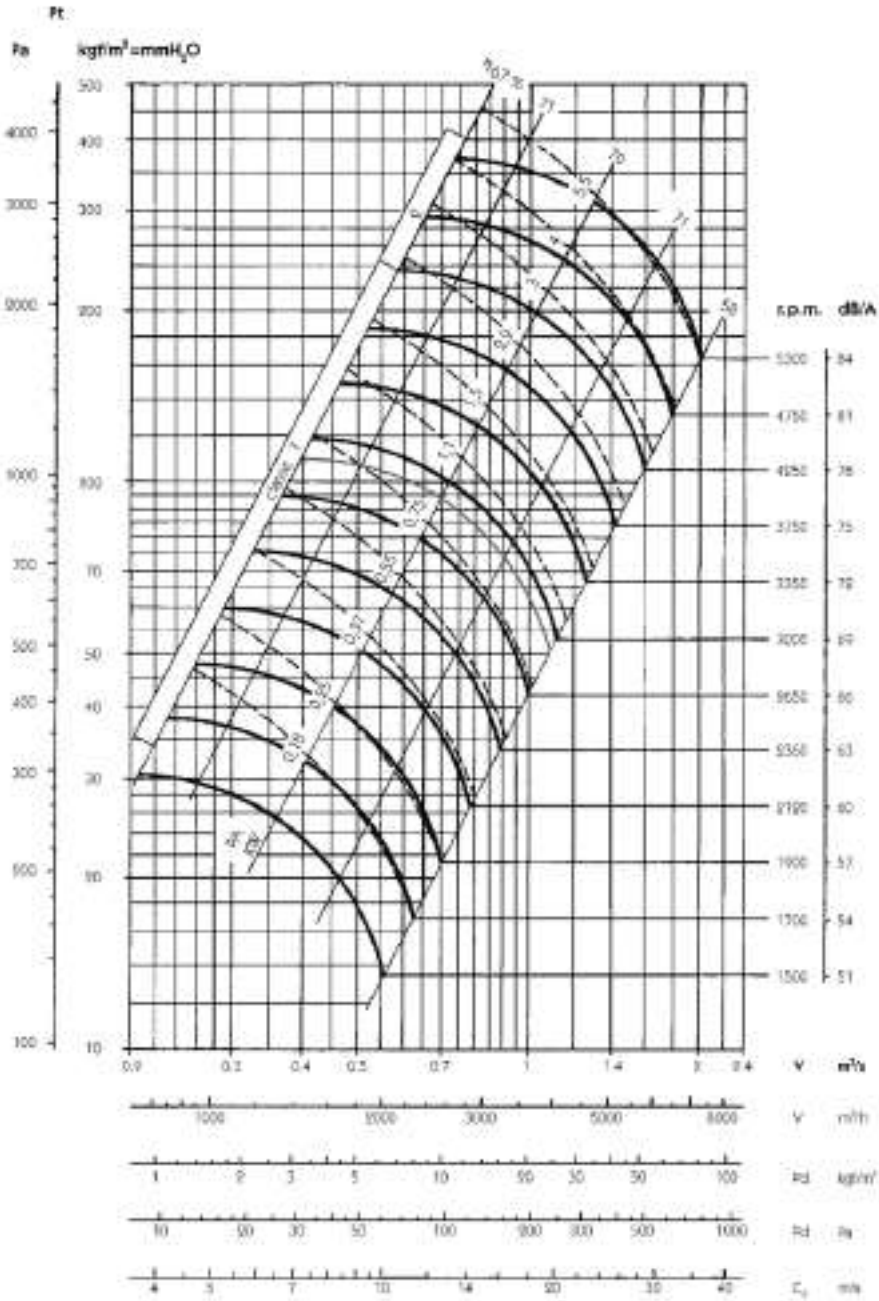

Margen sobre el caudal ±5%.
 Margen del nivel sonoro +3...5 dB.
 Margen kW absorbidos ±3%.

Características en impulsión.

Rpm máximas admisibles

	Clase 1	Clase 2
≤ 100°C	4000	5000
100...200°C	3550	4500
200...300°C	3150	4000

Curvas Características

CMRS-X 310

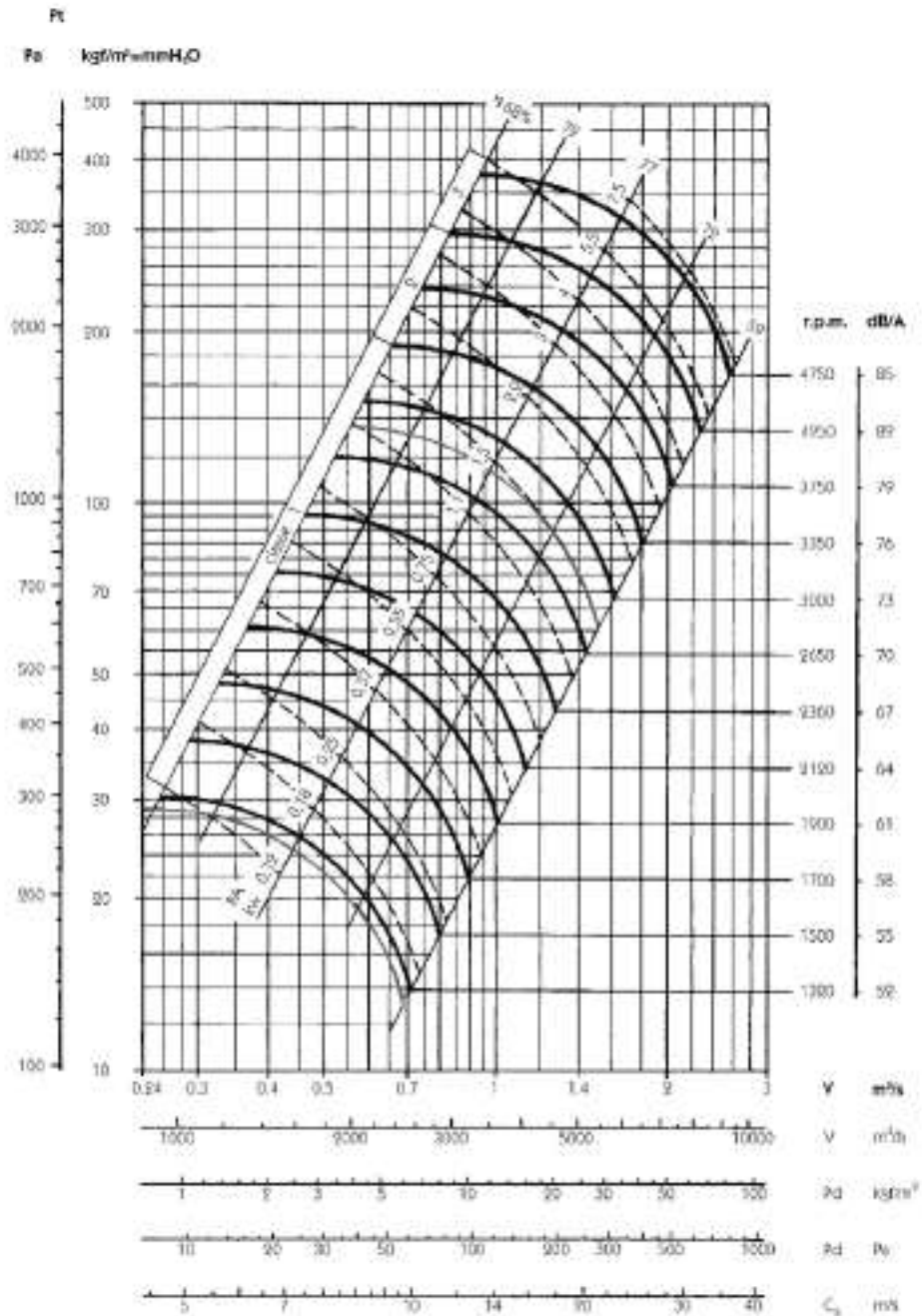

Margen sobre el caudal $\pm 5\%$.
 Margen del nivel sonoro $+3...5$ dB.
 Margen kW absorbidos $\pm 3\%$.

Características en impulsión.

Rpm máximas admisibles

	Clase 1	Clase 2	Clase 3
$\leq 100^\circ\text{C}$	3150	4000	5000
100...200°C	2800	3550	4500
200...300°C	2500	3150	4000

Curvas Características

CMRS-X 350

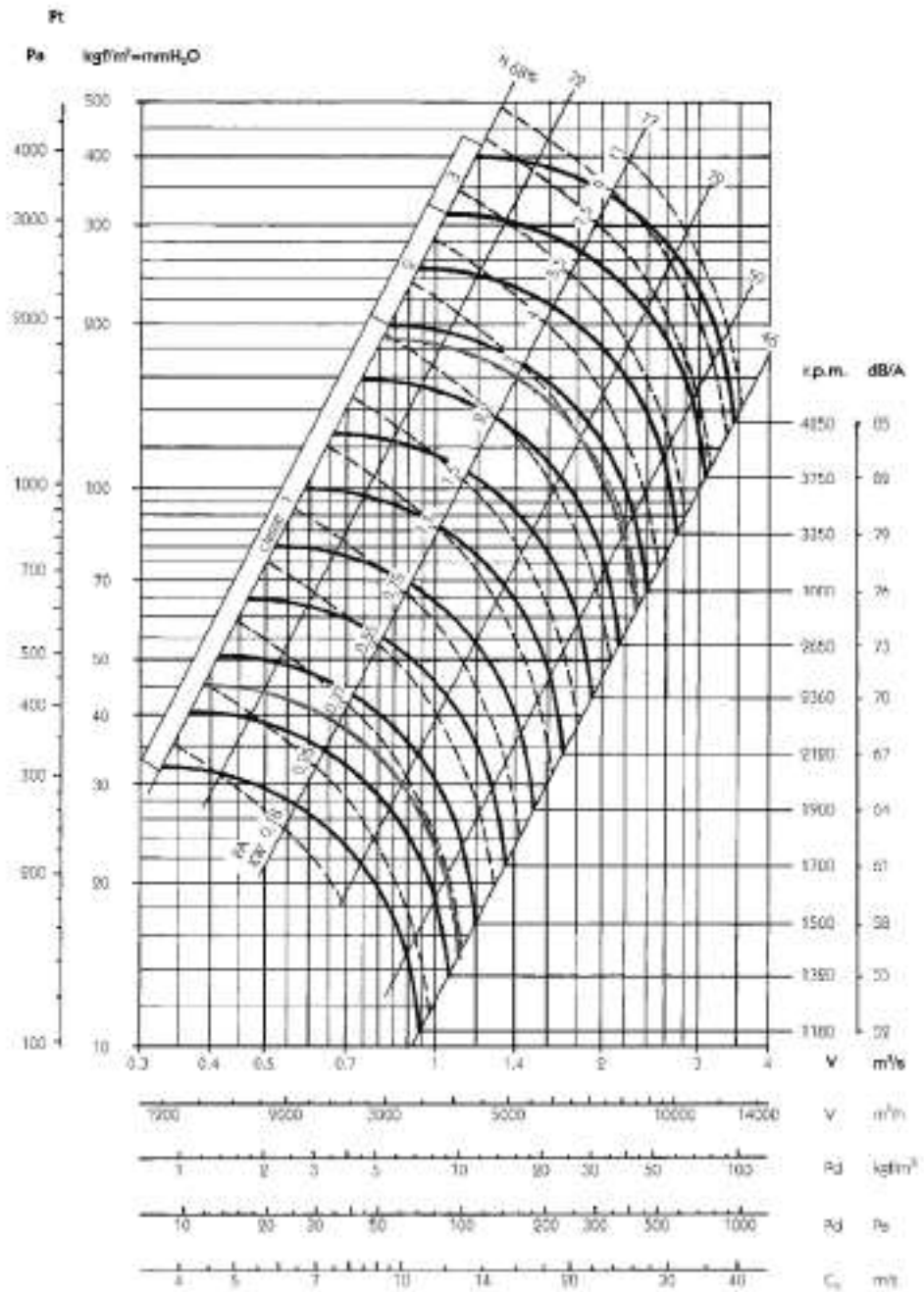

LARGE SERIES

Margen sobre el caudal ±5%.
 Margen del nivel sonoro +3...5 dB.
 Margen kW absorbidos ±3%.

Rpm máximas admisibles

	Clase 1	Clase 2	Clase 3
≤ 100°C	2800	3550	4500
100...200°C	2500	3150	4000
200...300°C	2240	2800	3550

Características en impulsión.

Curvas Características

CMRS-X 400

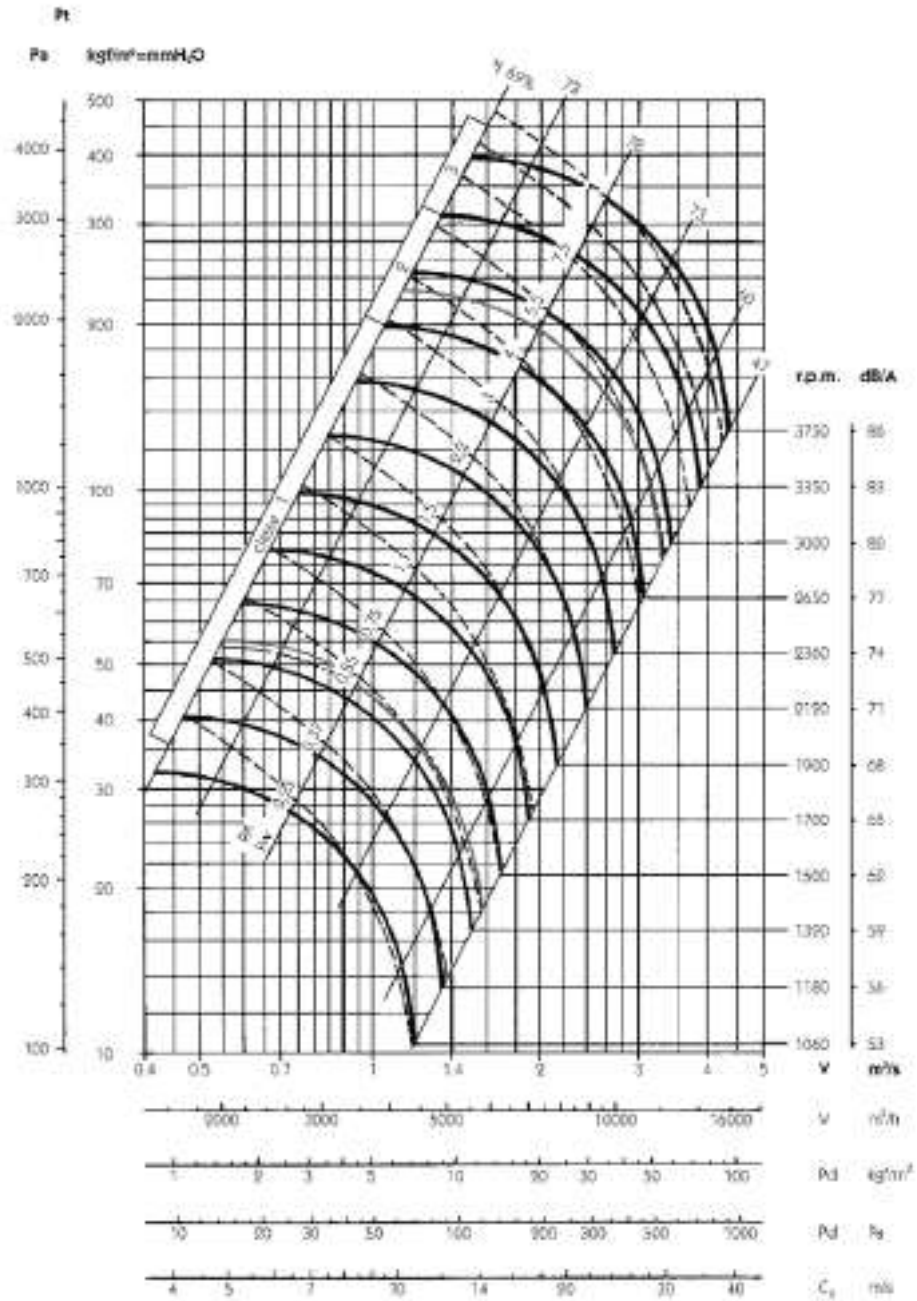

Margen sobre el caudal $\pm 5\%$.
 Margen del nivel sonoro $+3...5$ dB.
 Margen kW absorbidos $\pm 3\%$.

Características en impulsión.

Rpm máximas admisibles

	Clase 1	Clase 2	Clase 3
$\leq 100^{\circ}\text{C}$	2500	3150	4000
100...200°C	2240	2800	3550
200...300°C	2000	2500	3150

Curvas Características

CMRS-X 450

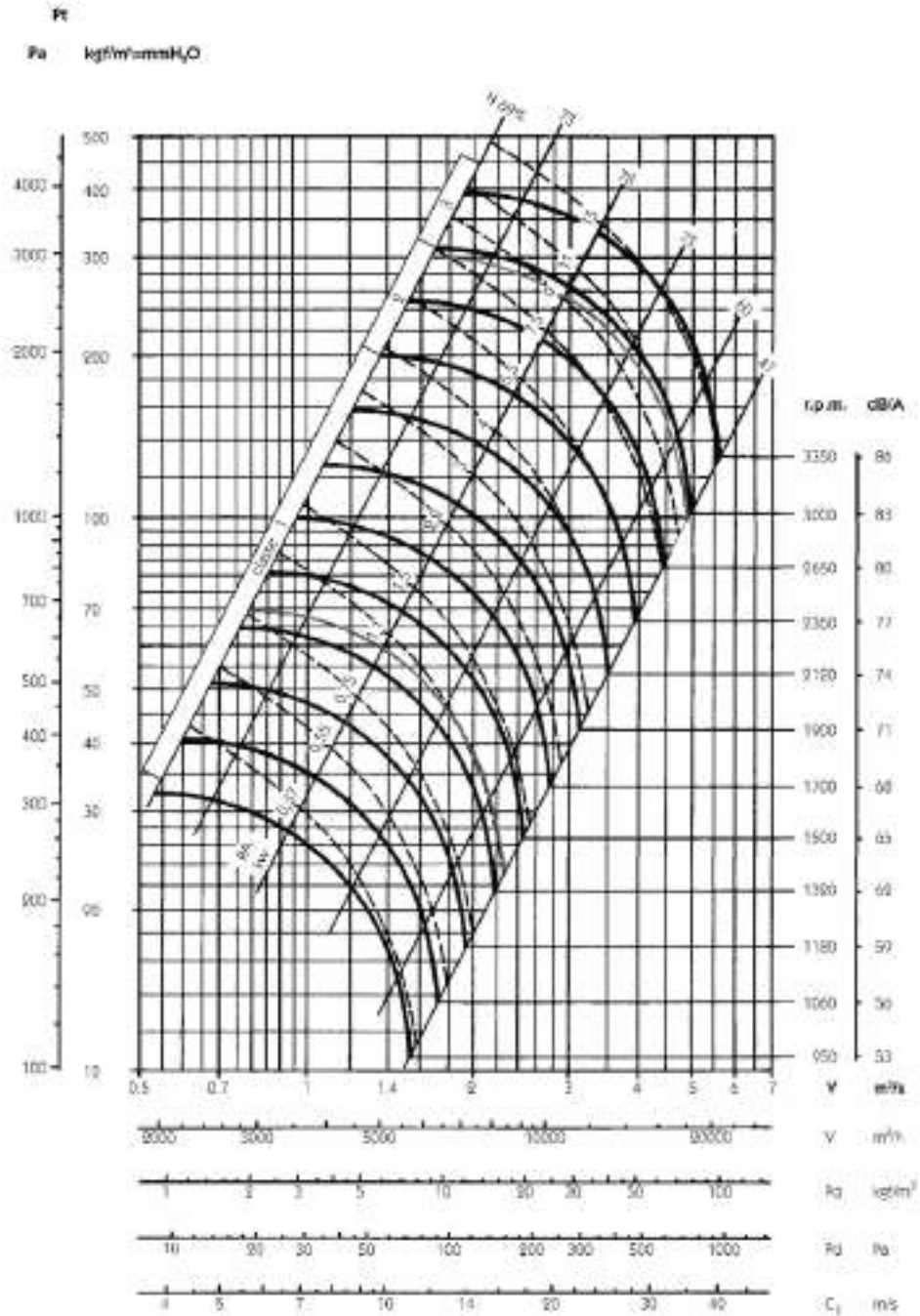

Margen sobre el caudal $\pm 5\%$.
 Margen del nivel sonoro $+3...5$ dB.
 Margen kW absorbidos $\pm 3\%$.

Características en impulsión.

Rpm máximas admisibles

	Clase 1	Clase 2	Clase 3
$\leq 100^\circ\text{C}$	2240	2800	3550
100...200°C	2000	2500	3150
200...300°C	1800	2250	2800

LARGE SERIES

Curvas Características

CMRS-X 500

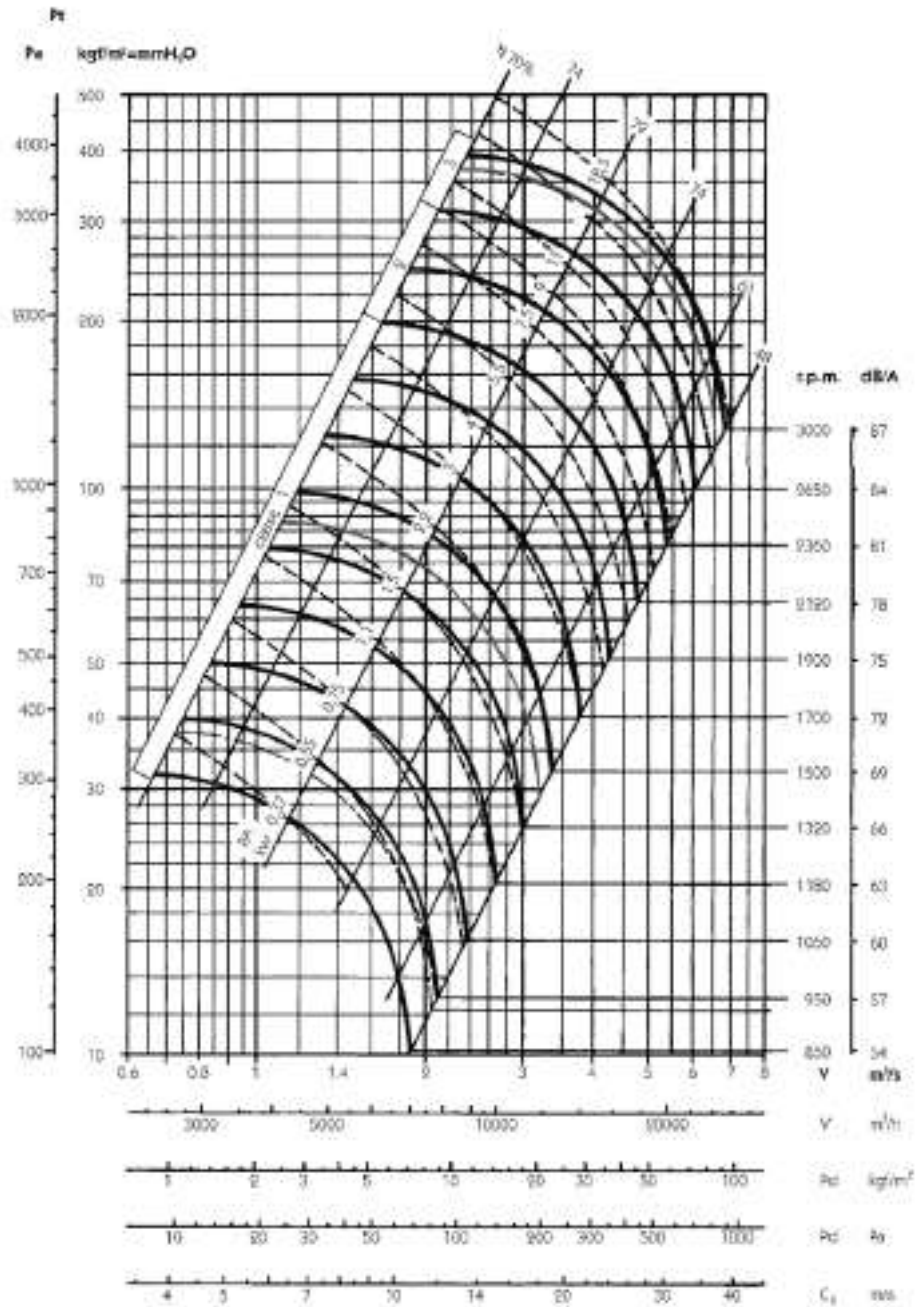

Margen sobre el caudal $\pm 5\%$.
 Margen del nivel sonoro $+3...5$ dB.
 Margen kW absorbidos $\pm 3\%$.

Características en impulsión.

Rpm máximas admisibles

	Clase 1	Clase 2	Clase 3
$\leq 100^{\circ}\text{C}$	2000	2500	3150
100...200 $^{\circ}\text{C}$	1800	2240	2800
200...300 $^{\circ}\text{C}$	1600	2000	2500

Curvas Características

CMRS-X 560

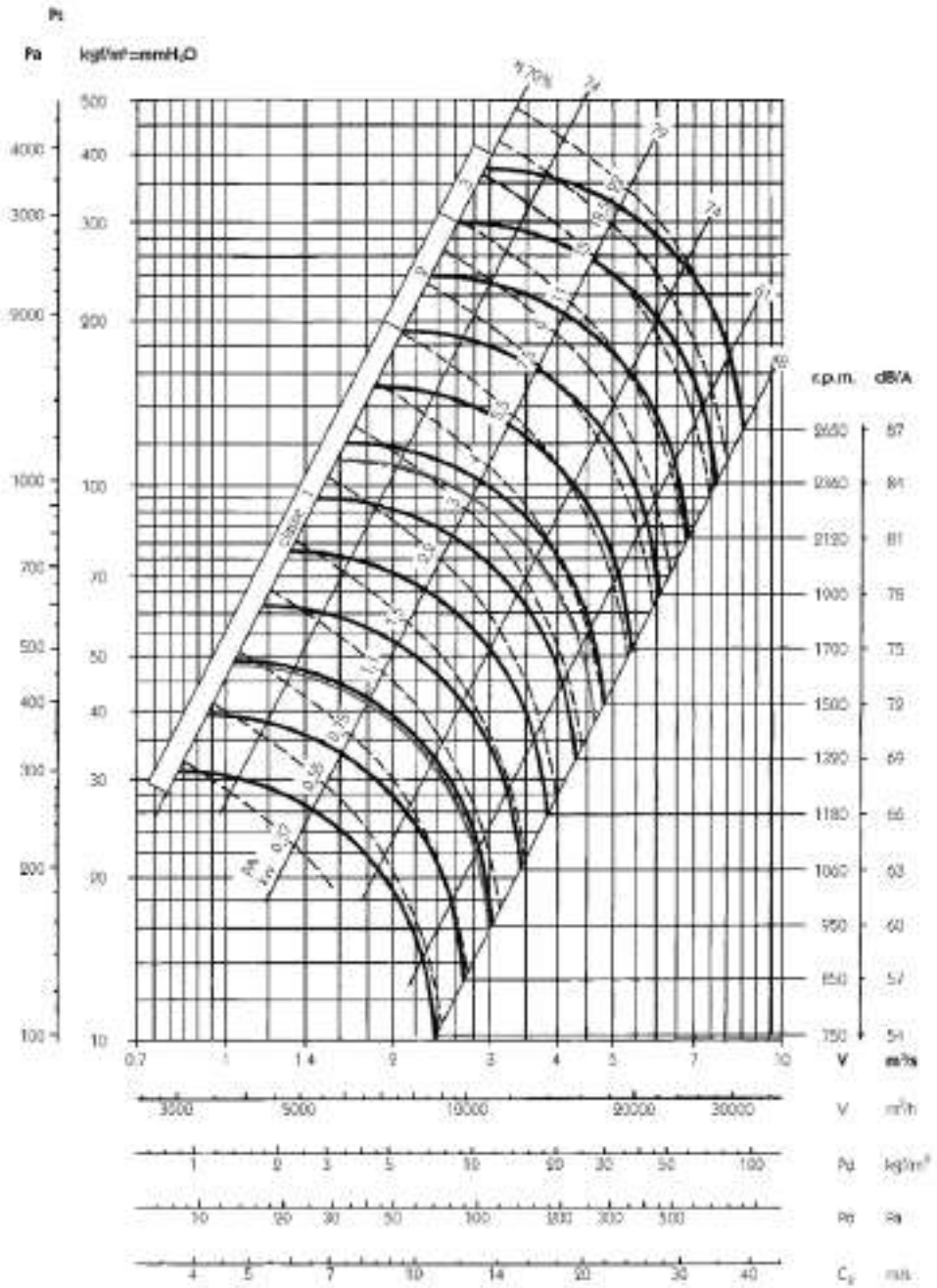

LARGE SERIES

Margen sobre el caudal ±5%.
 Margen del nivel sonoro +3...5 dB.
 Margen kW absorbidos ±3%.

Rpm máximas admisibles

	Clase 1	Clase 2	Clase 3
≤ 100°C	1800	2240	2800
100...200°C	1600	2000	2500
200...300°C	1400	1800	2240

Características en impulsión.

Curvas Características

CMRS-X 630

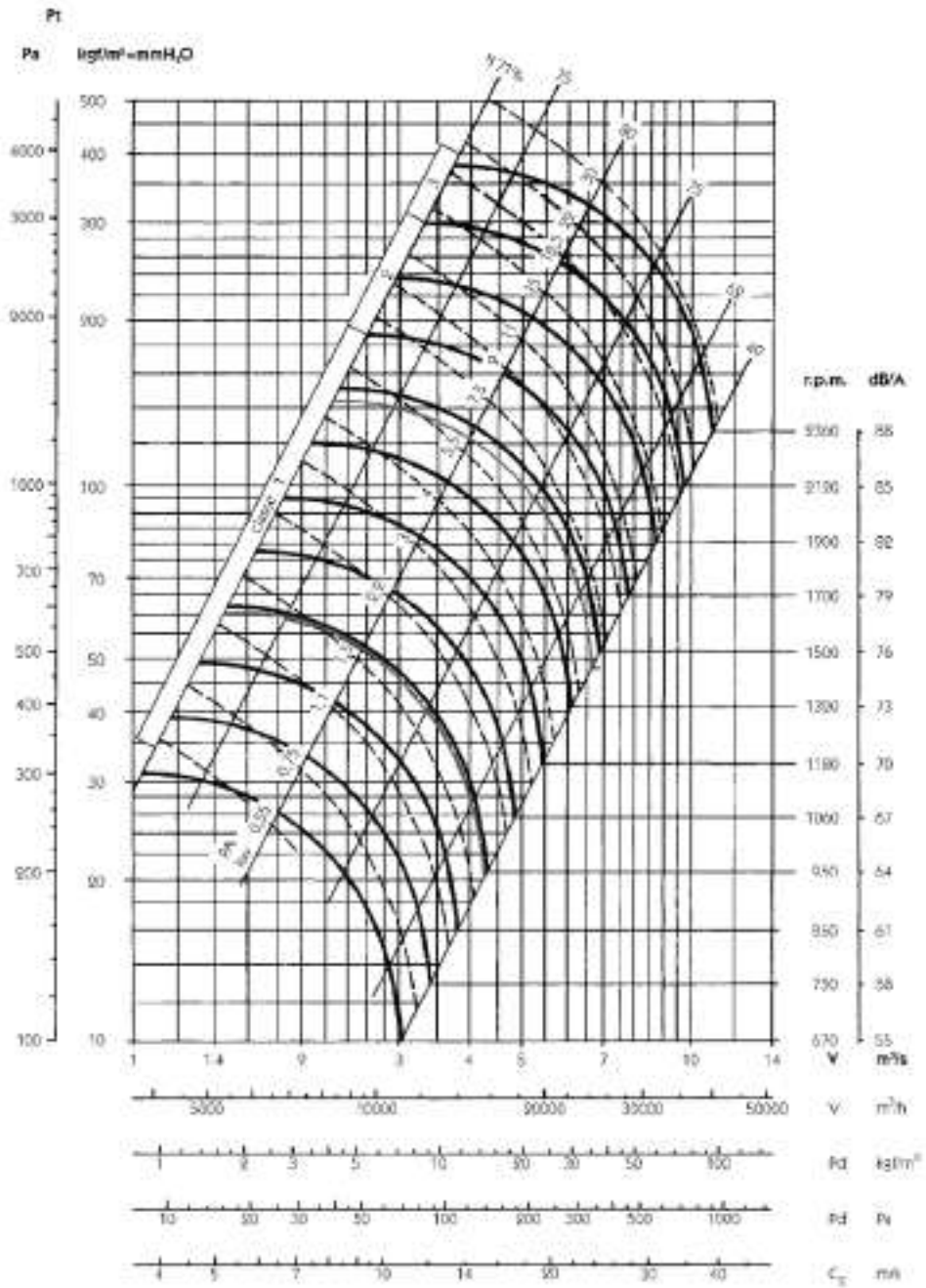

Margen sobre el caudal ±5%.
 Margen del nivel sonoro +3...5 dB.
 Margen kW absorbidos ±3%.

Rpm máximas admisibles

	Clase 1	Clase 2	Clase 3
≤ 100°C	1600	2000	2500
100...200°C	1400	1800	2240
200...300°C	1250	1600	2000

Características en impulsión.

Curvas Características

CMRS-X 710

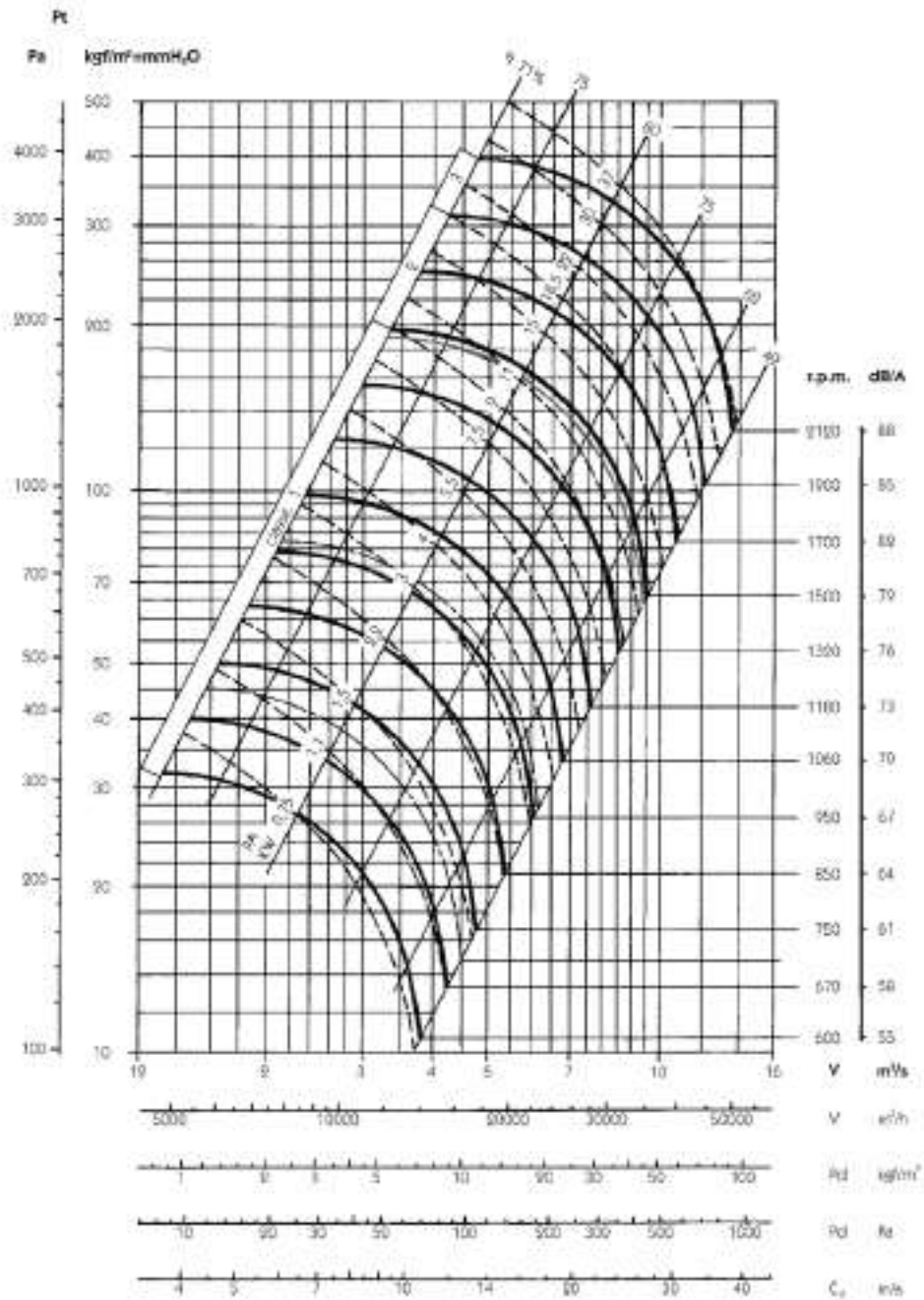

LARGE SERIES

Margen sobre el caudal ±5%.
 Margen del nivel sonoro +3...5 dB.
 Margen kW absorbidos ±3%.

Características en impulsión.

Rpm máximas admisibles

	Clase 1	Clase 2	Clase 3
≤ 100°C	1400	1800	2240
100...200°C	1250	1600	2000
200...300°C	1120	1400	1800

Curvas Características

CMRS-X 800

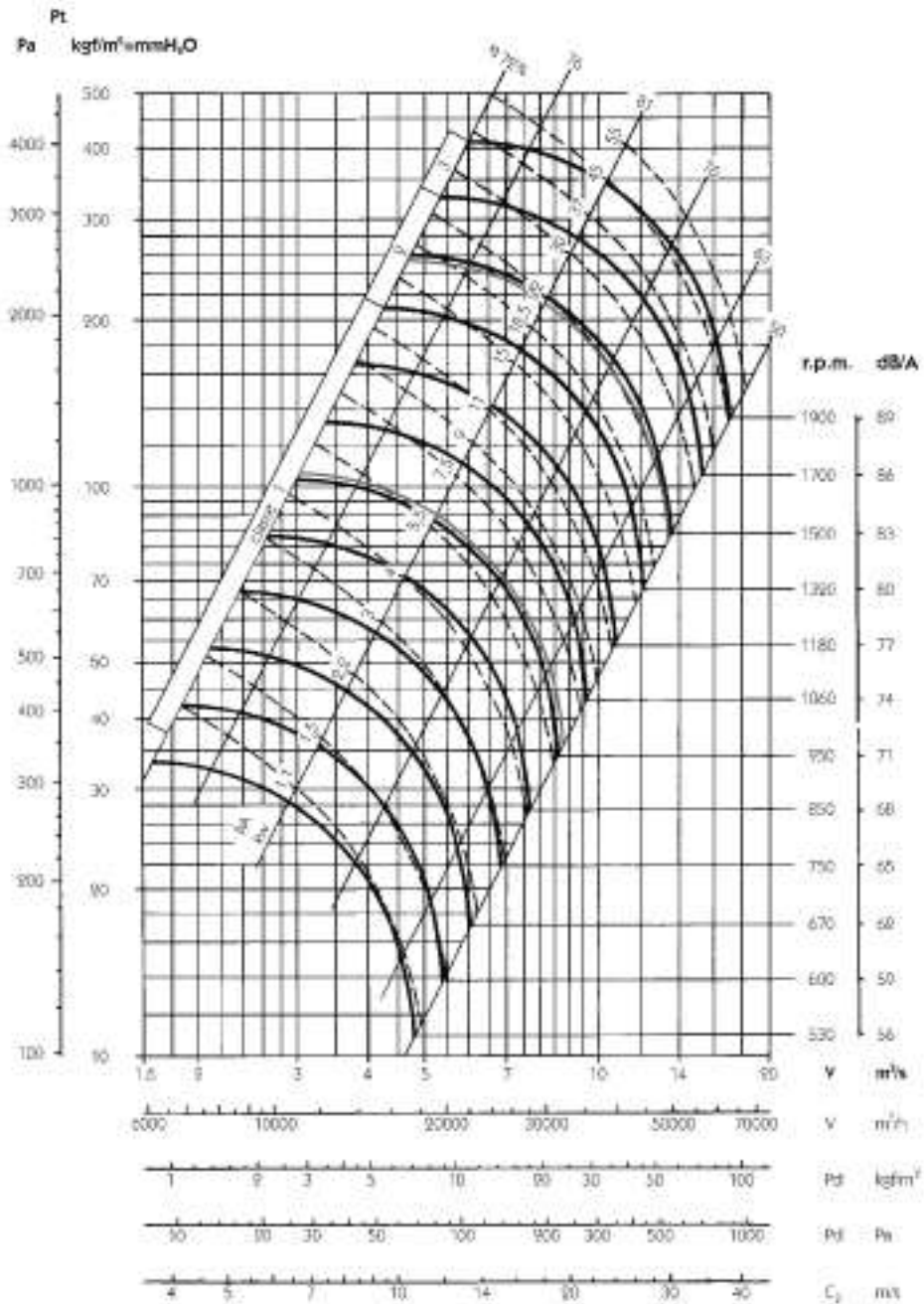

Margen sobre el caudal ±5%.
 Margen del nivel sonoro +3...5 dB.
 Margen kW absorbidos ±3%.

Características en impulsión.

Rpm máximas admisibles

	Clase 1	Clase 2	Clase 3
≤ 100°C	1250	1600	2000
100...200°C	1120	1400	1800
200...300°C	1000	1250	1600

LARGE SERIES

Curvas Características

CMRS-X 900

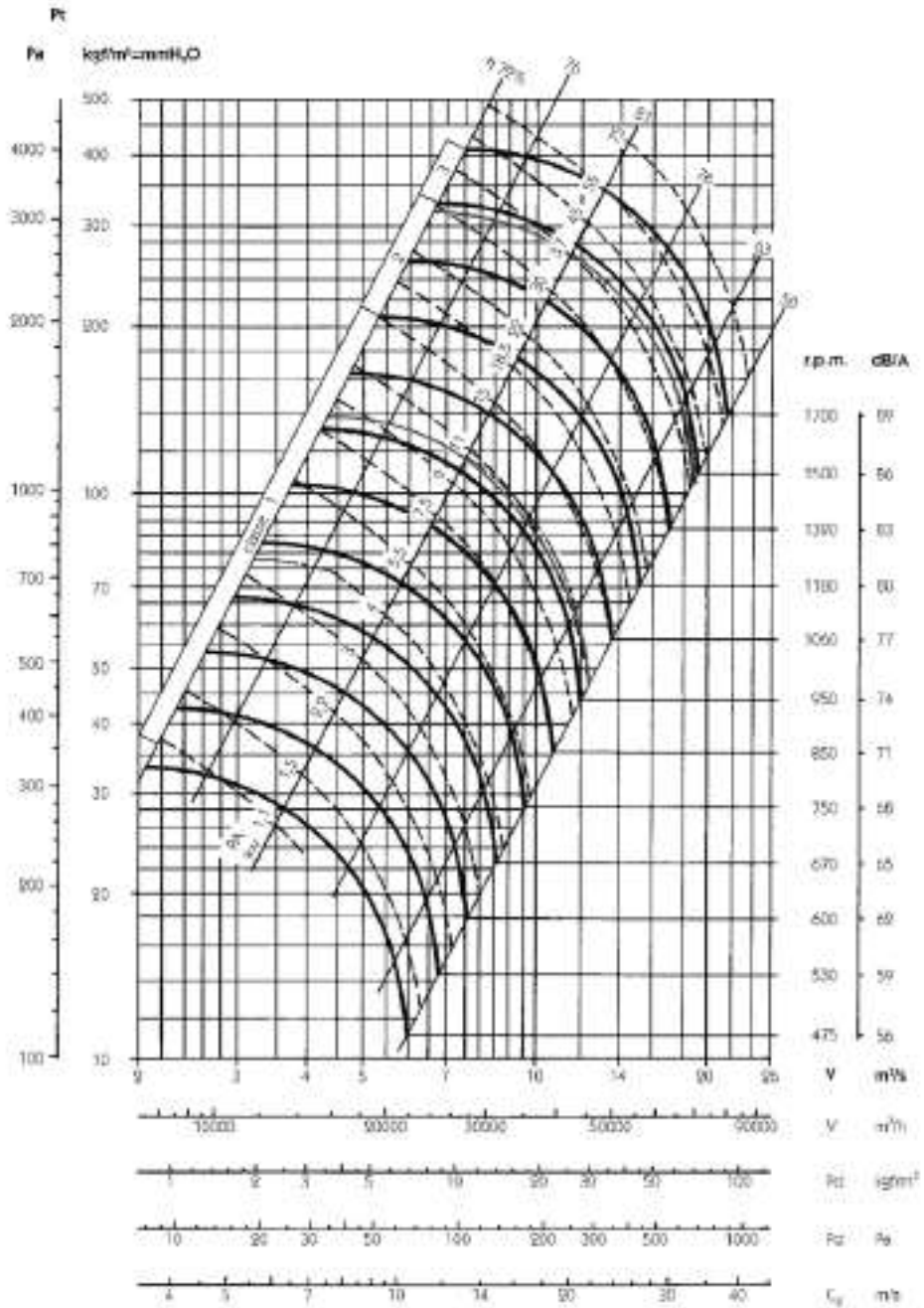

Margen sobre el caudal ±5%.
 Margen del nivel sonoro +3...5 dB.
 Margen kW absorbidos ±3%.

Características en impulsión.

Rpm máximas admisibles

	Clase 1	Clase 2	Clase 3
≤ 100°C	1120	1400	1800
100...200°C	1000	1250	1600
200...300°C	900	1120	1400

LARGE SERIES

Curvas Características

CMRS-X 1000

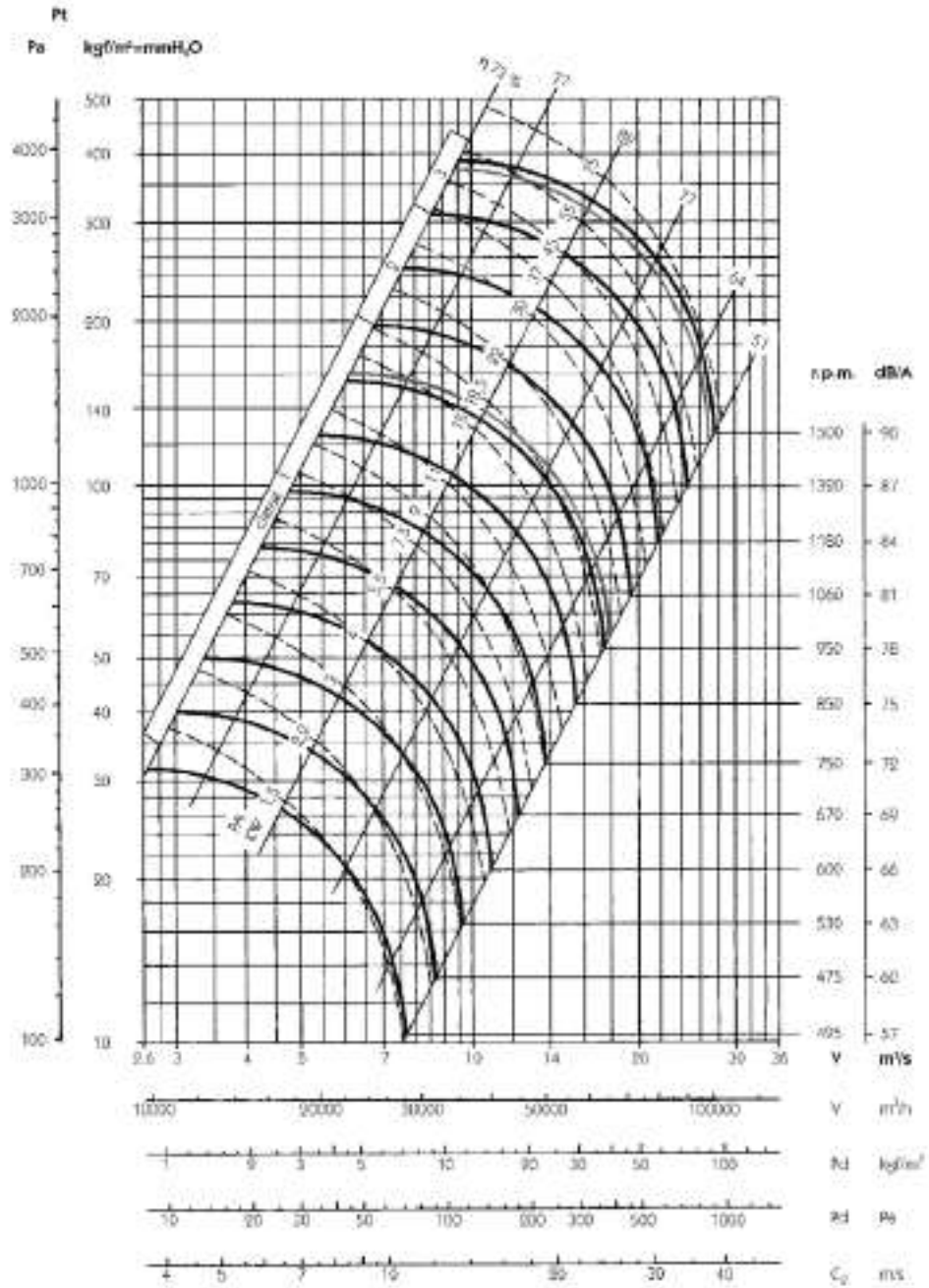

Margen sobre el caudal ±5%.
 Margen del nivel sonoro +3...5 dB.
 Margen kW absorbidos ±3%.

Rpm máximas admisibles

	Clase 1	Clase 2	Clase 3
≤ 100°C	1000	1250	1600
100...200°C	900	1120	1400
200...300°C	800	1000	1250

Características en impulsión.

Curvas Características

CMRS-X 1120

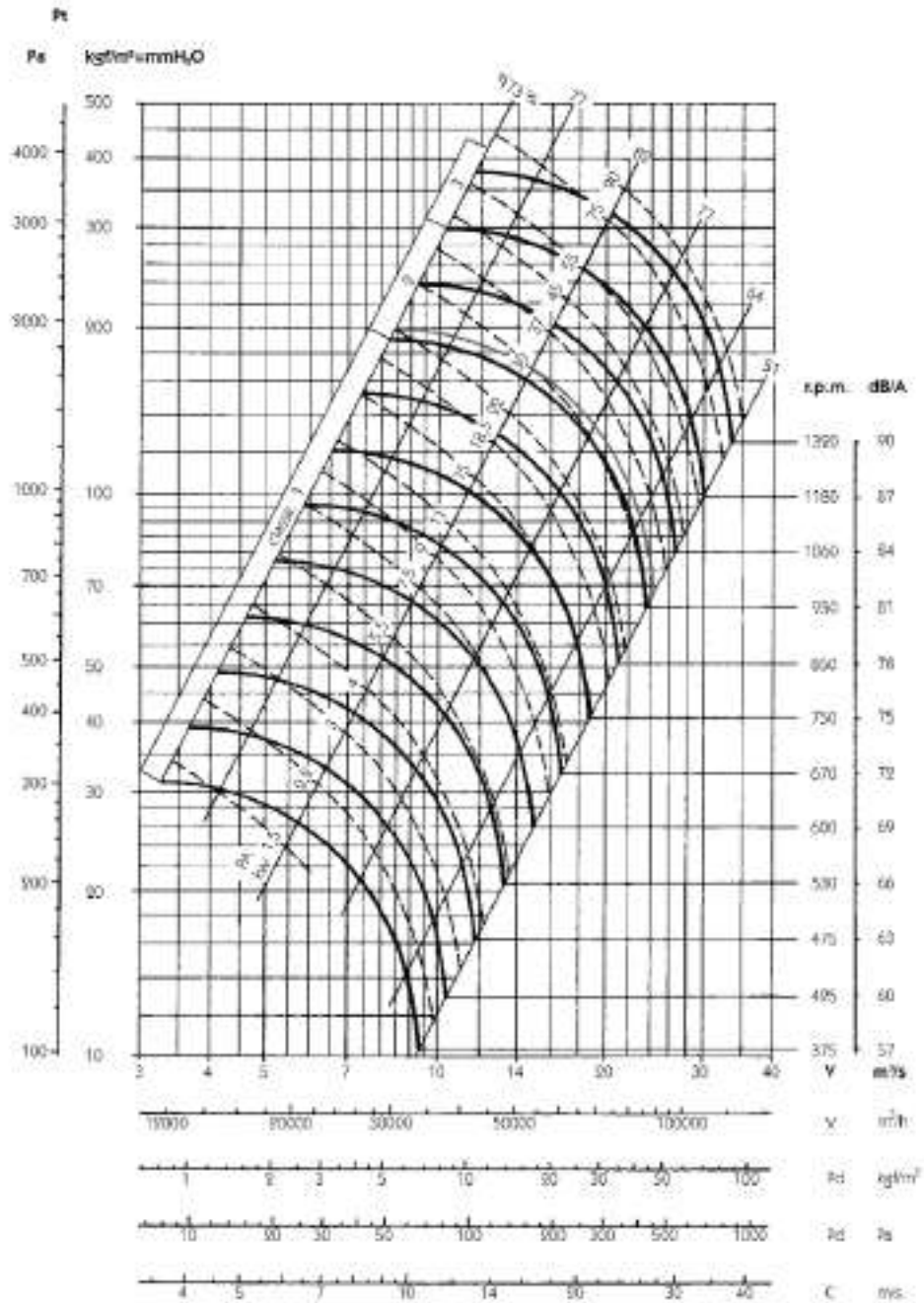

Margen sobre el caudal ±5%.
 Margen del nivel sonoro +3...5 dB.
 Margen kW absorbidos ±3%.

Rpm máximas admisibles

	Clase 1	Clase 2	Clase 3
≤ 100°C	900	1120	1400
100...200°C	800	1000	1250
200...300°C	710	900	1120

Características en impulsión.

LARGE SERIES

Curvas Características

CMRS-X 1250

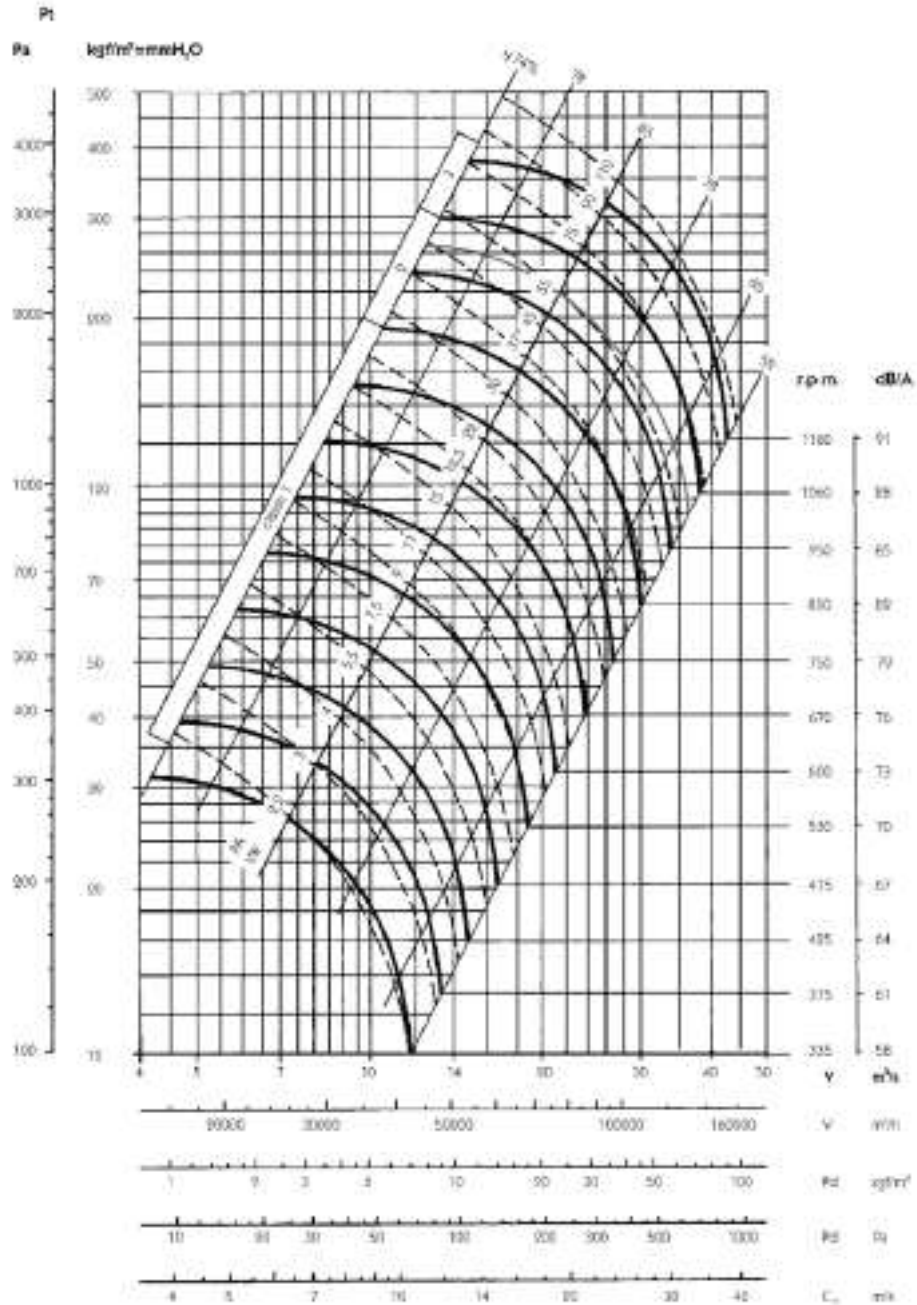

Margen sobre el caudal $\pm 5\%$.
 Margen del nivel sonoro $+3...5$ dB.
 Margen kW absorbidos $\pm 3\%$.

Características en impulsión.

Rpm máximas admisibles

	Clase 1	Clase 2	Clase 3
$\leq 100^\circ\text{C}$	800	1000	1250
100...200°C	710	900	1120
200...300°C	630	800	1000

Curvas Características

CMRS-X 1400

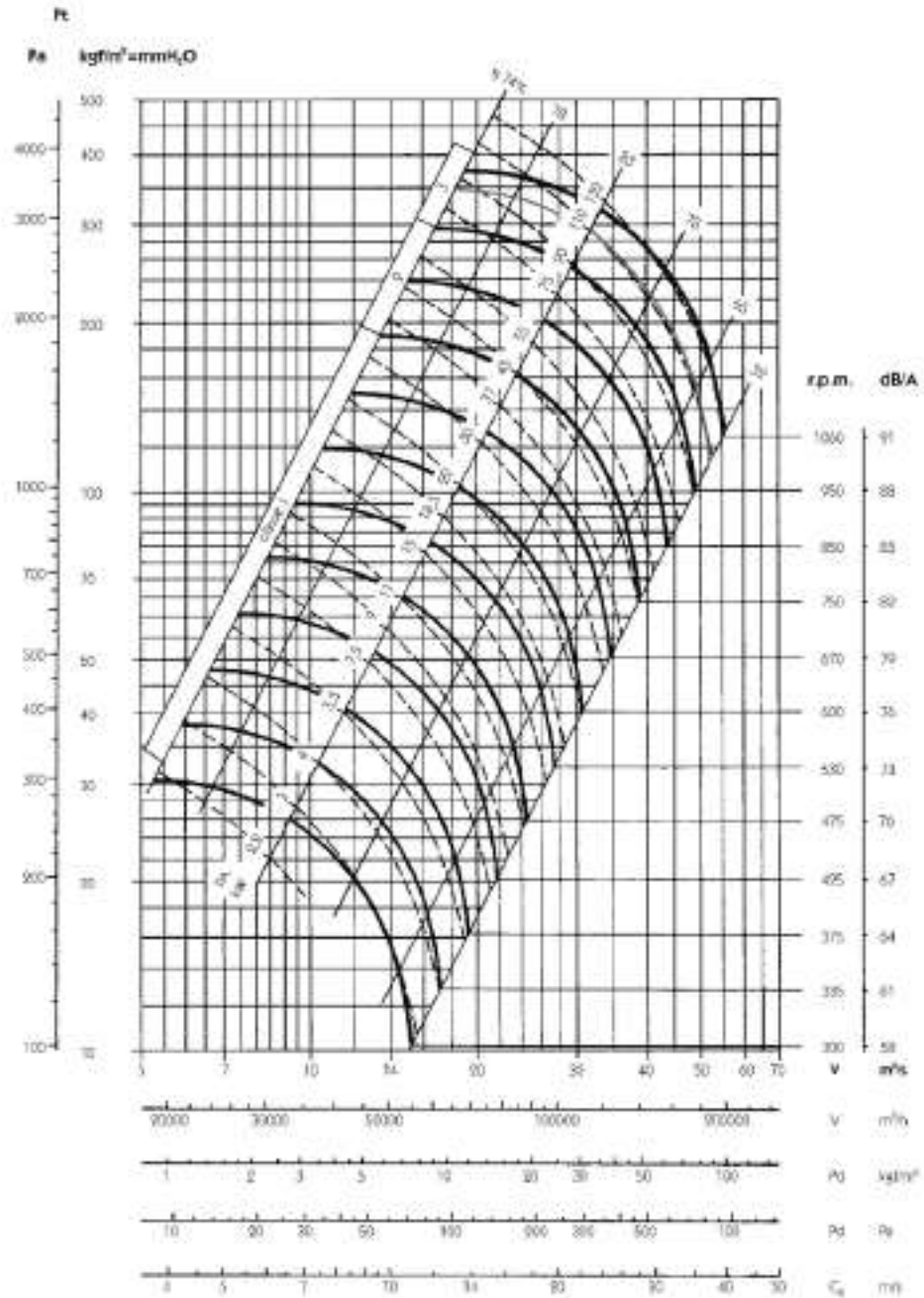

Margen sobre el caudal ±5%.
 Margen del nivel sonoro +3...5 dB.
 Margen kW absorbidos ±3%.

Características en impulsión.

Rpm máximas admisibles

	Clase 1	Clase 2	Clase 3
≤ 100°C	710	900	1120
100...200°C	630	800	1000
200...300°C	560	710	900

Curvas Características

CMRS-X 1600

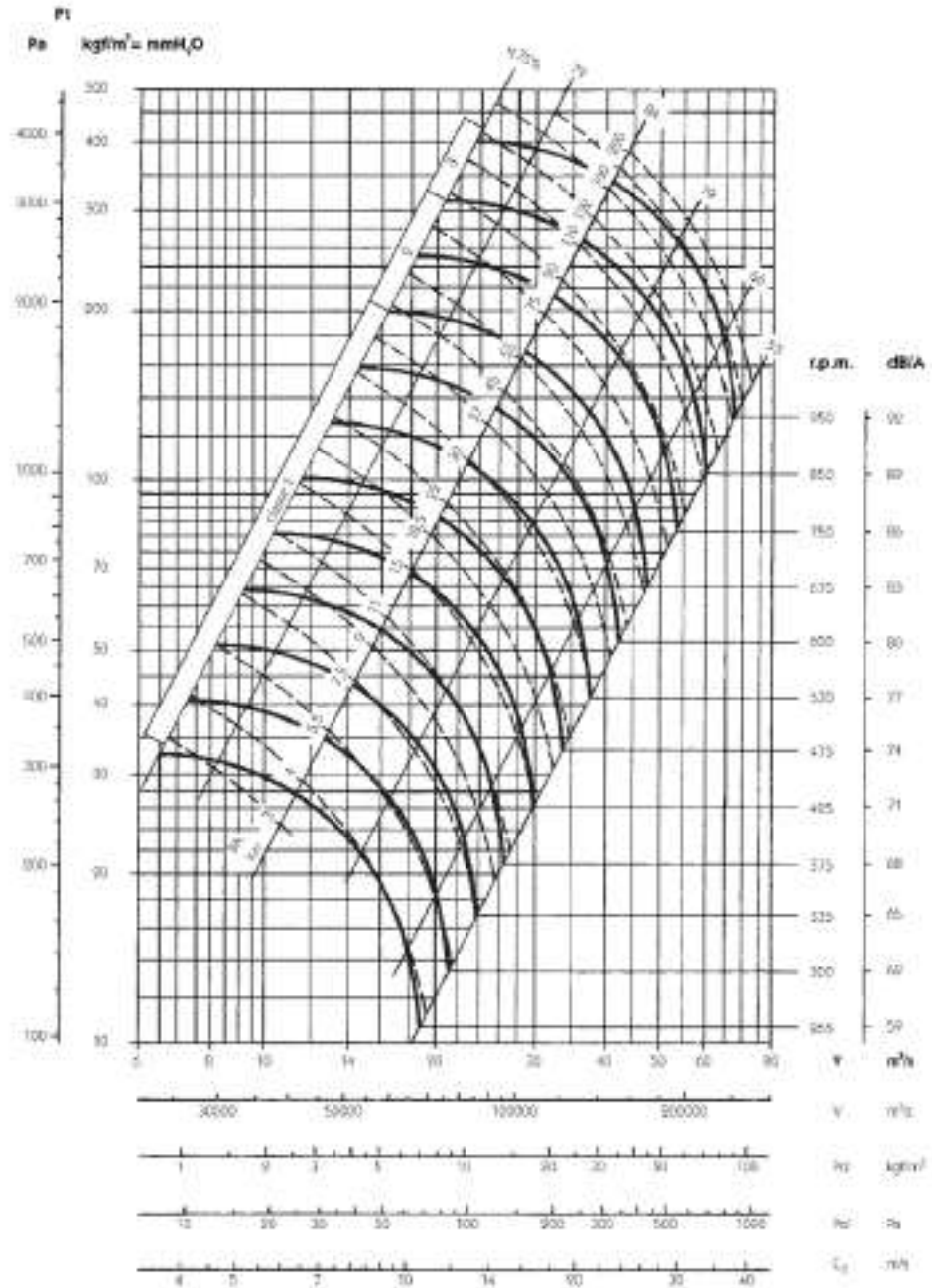

Margen sobre el caudal $\pm 5\%$.
 Margen del nivel sonoro $+3...5 \text{ dB}$.
 Margen kW absorbidos $\pm 3\%$.

Características en impulsión.

Rpm máximas admisibles

	Clase 1	Clase 2	Clase 3
$\leq 100^\circ\text{C}$	630	800	1000
100...200°C	560	710	900
200...300°C	500	630	800

Curvas Características

CMRS-X 1800

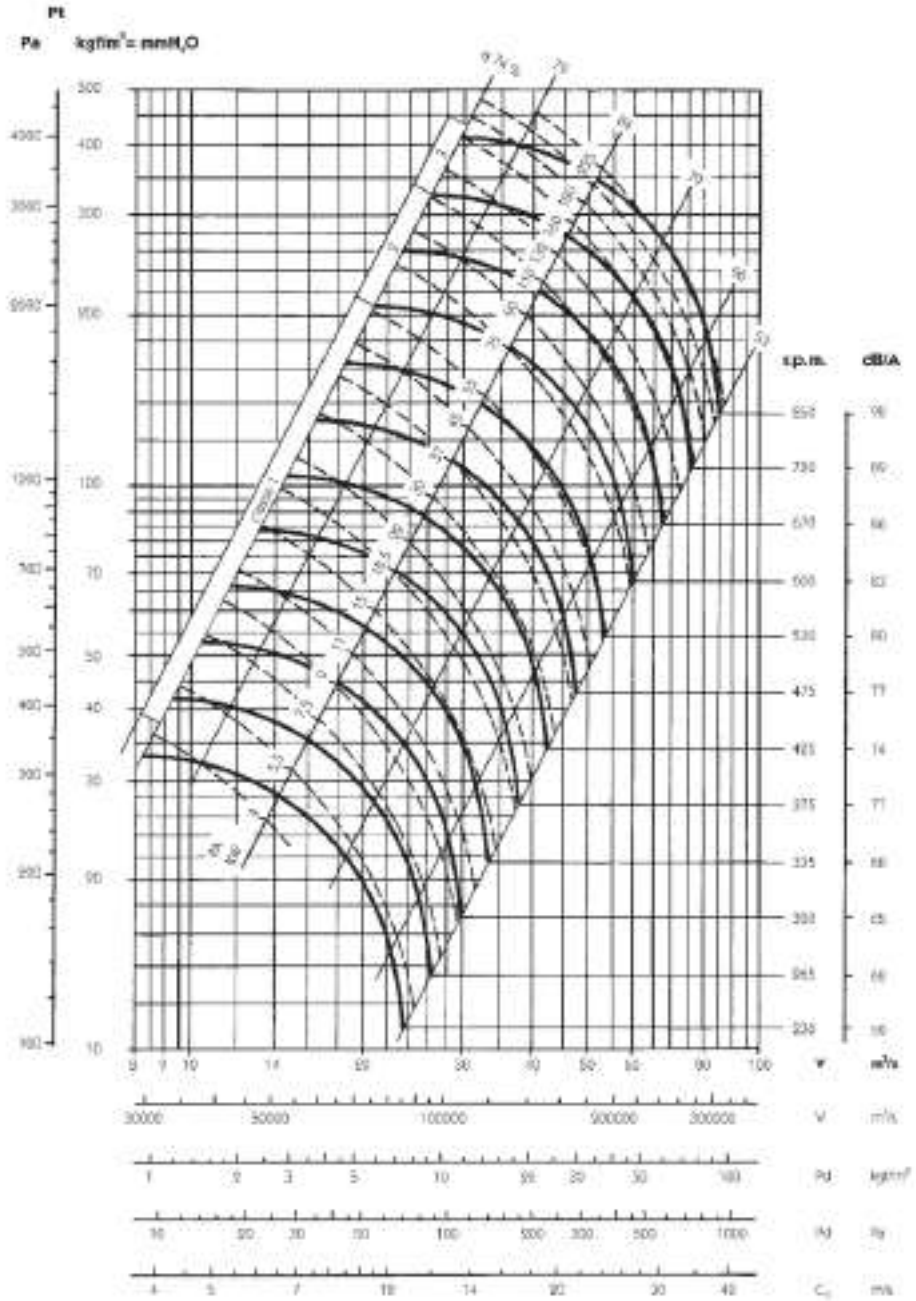

LARGE SERIES

Margen sobre el caudal ±5%.
 Margen del nivel sonoro +3...5 dB.
 Margen kW absorbidos ±3%.

Características en impulsión.

Rpm máximas admisibles

	Clase 1	Clase 2	Clase 3
≤ 100°C	560	710	900
100...200°C	500	630	800
200...300°C	450	560	710

Curvas Características

CMRS-X 2000

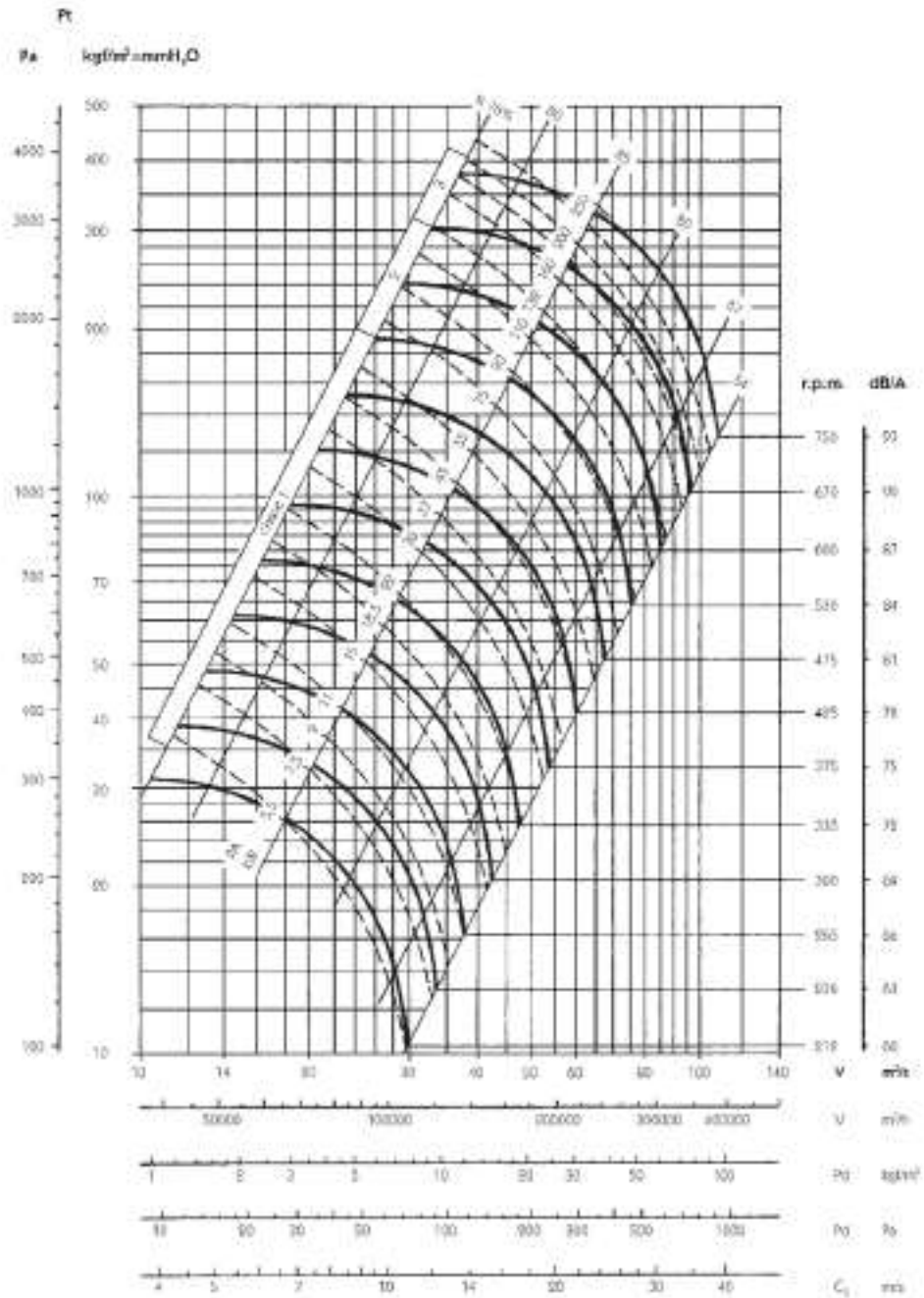

LARGE SERIES

Margen sobre el caudal $\pm 5\%$.
 Margen del nivel sonoro $+3...5$ dB.
 Margen kW absorbidos $\pm 3\%$.

Características en impulsión.

Rpm máximas admisibles

	Clase 1	Clase 2	Clase 3
$\leq 100^\circ\text{C}$	500	630	800
100...200°C	450	560	710
200...300°C	400	500	630

Dimensiones mm

SISTEMA
4

CMRS 350...500

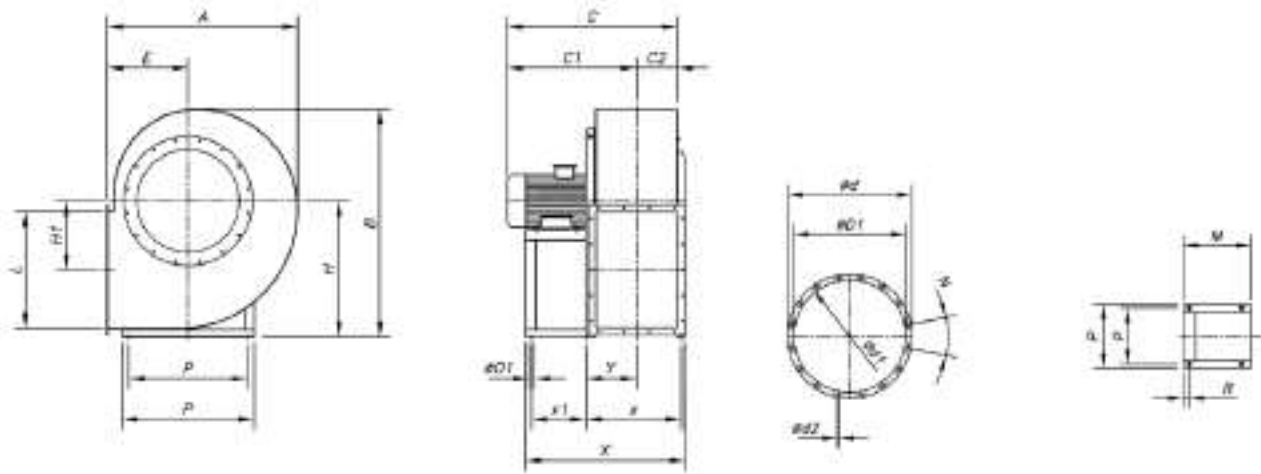

Modelo	Frame	A	B	C	C1	C2	ØD1	Ød	Ød1	Ød2	N	E	H	H1	L	M	R	ØO1	P	p	X	x1	Y
CMRS-350-2T-4	100 LA/2	592	743	594	464	130	360	434	405	12	8X45°	255	450	215	361	295	23	12	324	289	596	249	156
CMRS-350-4T-0.5	71 B/4	592	743	491	361	130	360	434	405	12	8X45°	255	450	215	361	220	14	10	225	203	521	156	183
CMRS-400-2T-5.5	112 M/2	666	824	641	495	146	405	491	448	12	8X45°	285	500	242	404	310	23	12	324	289	643	264	172
CMRS-400-2T-7.5	132 SA/2	666	824	670	524	146	405	491	448	12	8X45°	285	500	243	404	360	23	12	372	337	693	314	172
CMRS-400-4T-0.75	80 A/4	666	824	540	394	146	405	491	448	12	8X45°	285	500	243	404	225	14	10	225	203	558	166	194
CMRS-450-2T-10	132 SB/2	751	920	744	581	163	455	524	497	12	12X30°	320	560	273	453	360	23	12	372	337	728	314	190
CMRS-450-2T-15	160 MA/2	751	920	812	649	163	455	524	497	12	12X30°	320	560	273	453	470	28	14	440	395	838	414	195
CMRS-450-4T-1	80 B/4	751	920	575	412	163	455	524	497	12	12X30°	320	560	273	453	225	14	10	225	203	593	166	212
CMRS-450-4T-1.5	90 S/4	751	920	600	437	163	455	524	497	12	12X30°	320	560	273	453	260	17	10	260	234	628	183	227
CMRS-500-2T-20	160 MB/2	842	1024	853	670	183	505	580	551	12	12X30°	360	600	301	507	465	28	14	440	395	872	414	210
CMRS-500-2T-25	160 L/2	842	1024	952	769	183	505	580	551	12	12X30°	360	600	301	507	465	28	14	440	395	872	414	210
CMRS-500-4T-2	90 L/4	842	1024	639	456	183	505	580	551	12	12X30°	360	600	301	507	260	17	10	260	234	667	183	247
CMRS-500-4T-3	100 LA/4	842	1024	668	485	183	505	580	551	12	12X30°	360	600	301	507	295	23	12	324	289	702	249	210
CMRS-500-6T-0.75	80 B/6	842	1024	614	431	183	505	580	551	12	12X30°	360	600	301	507	225	14	10	225	203	632	166	232

BOCA DE IMPULSIÓN

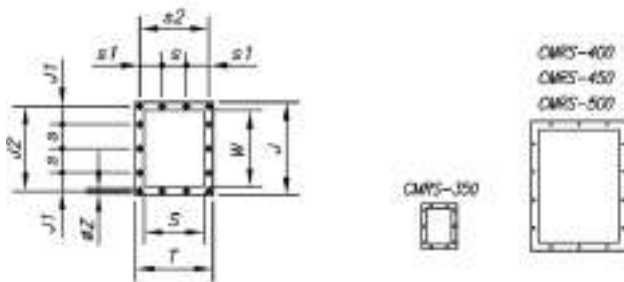

Modelo	T	J	J1	J2	S	s	s1	s2	W	ØZ
CMRS-350-2T-4	336	441	77	405	260	125	87	300	365	12
CMRS-350-4T-0.5	336	441	77	405	260	125	87	300	365	12
CMRS-400-2T-5.5	368	484	36	448	292	125	41	332	408	12
CMRS-400-2T-7.5	368	484	36	448	292	125	41	332	408	12
CMRS-400-4T-0.75	368	484	36	448	292	125	41	332	408	12
CMRS-450-2T-10	402	533	61	497	326	125	58	366	457	12
CMRS-450-2T-15	402	533	61	497	326	125	58	366	457	12
CMRS-450-4T-1	402	533	61	497	326	125	58	366	457	12
CMRS-450-4T-1.5	402	533	61	497	326	125	58	366	457	12
CMRS-500-2T-20	441	587	88	551	365	125	77	405	511	12
CMRS-500-2T-25	441	587	88	551	365	125	77	405	511	12
CMRS-500-4T-2	441	587	88	551	365	125	77	405	511	12
CMRS-500-4T-3	441	587	88	551	365	125	77	405	511	12
CMRS-500-6T-0.75	441	587	88	551	365	125	77	405	511	12

LARGE SERIES

Dimensiones mm

CMRS 560...800

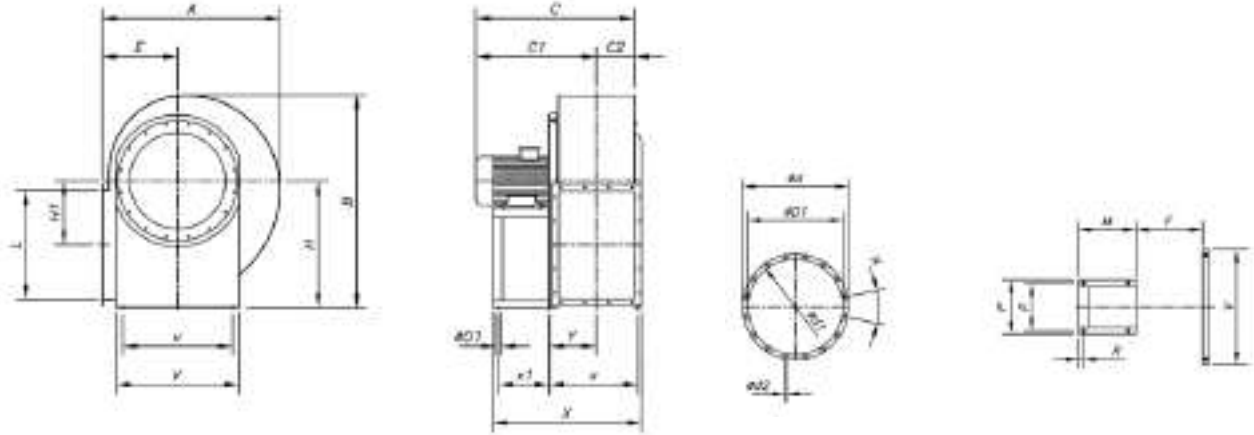

Modelo	Frame	A	B	C	C1	C2	ØD1	Ød	Ød1	Ød2	N	E	H	H1	L	F	M	R	ØO1	P	p	V	v	X	x	x1	Y
CMRS-560-4T-4	100 LB/4	938	1139	711	507	204	565	658	629	12	12X30°	400	670	331	569	412	295	23	12	324	289	720	632	762	464	249	231
CMRS-560-4T-5.5	112 M/4	938	1139	758	554	204	565	658	629	12	12X30°	400	670	331	569	412	310	23	12	324	289	720	632	777	464	264	231
CMRS-560-6T-1	90 S/6	938	1139	682	478	204	565	658	629	12	12X30°	400	670	331	569	412	260	17	10	260	234	720	632	727	501	183	268
CMRS-560-6T-1.5	90 L/6	938	1139	682	478	204	565	658	629	12	12X30°	400	670	331	569	412	260	17	10	260	234	720	632	727	501	183	268
CMRS-630-4T-7.5	132 S/4	1053	1279	877	648	229	635	738	698	12	12X30°	450	750	375	644	462	360	23	12	372	337	780	702	877	514	314	256
CMRS-630-4T-10	132 MA/4	1053	1279	941	712	229	635	738	698	12	12X30°	450	750	375	644	462	360	23	12	372	337	780	702	877	514	314	256
CMRS-630-6T-2	100 LA/6	1053	1279	761	532	229	635	738	698	12	12X30°	450	750	375	644	462	295	23	12	324	289	780	702	805	514	249	256
CMRS-630-6T-3	112 M/6	1053	1279	808	579	229	635	738	698	12	12X30°	450	750	375	644	462	310	23	12	324	289	780	702	827	514	264	256
CMRS-710-4T-15	160 M/4	1178	1436	996	738	258	715	825	775	14	16x22°30'	500	850	431	715	513	478	39	19	836	734	887	772	1059	617	372	323
CMRS-710-4T-20	160 L/4	1178	1436	1094	836	258	715	825	775	14	16x22°30'	500	850	431	715	513	478	39	19	836	734	887	772	1059	617	372	323
CMRS-710-6T-4	132 SA/6	1178	1436	931	673	258	715	825	775	14	16x22°30'	500	850	431	715	513	369	39	19	836	734	887	772	950	617	263	323
CMRS-710-6T-5.5	132 MA/6	1178	1436	996	738	258	715	825	775	14	16x22°30'	500	850	431	715	513	369	39	19	836	734	887	772	950	617	263	323
CMRS-800-4T-25	180 M/4	1313	1593	1140	851	289	805	920	861	14	16x22°30'	560	950	482	801	577	547	39	19	926	862	968	867	1192	681	441	356
CMRS-800-4T-30	180 L/4	1313	1593	1178	889	289	805	920	861	14	16x22°30'	560	950	482	801	577	547	39	19	926	862	968	867	1192	681	441	356
CMRS-800-6T-7.5	132 M/6	1313	1593	1059	770	289	805	920	861	14	16x22°30'	560	950	482	801	577	369	39	19	926	862	968	867	1014	681	263	356
CMRS-800-6T-10	160 M/6	1313	1593	1059	770	289	805	920	861	14	16x22°30'	560	950	482	801	577	478	39	19	926	862	968	867	1123	681	372	356

BOCA DE IMPULSIÓN

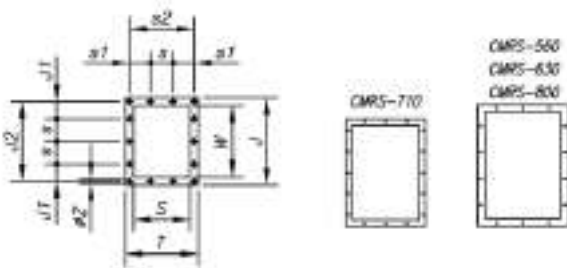

Modelo	T	J	J1	J2	S	s	s1	s2	W	ØZ
CMRS-560-4T-4	504	669	74	629	412	160	72	464	573	14
CMRS-560-4T-5.5	504	669	74	629	412	160	72	464	573	14
CMRS-560-6T-1	504	669	74	629	412	160	72	464	573	14
CMRS-560-6T-1.5	504	669	74	629	412	160	72	464	573	14
CMRS-630-4T-7.5	553	738	109	698	462	160	96	513	644	14
CMRS-630-4T-10	553	738	109	698	462	160	96	513	644	14
CMRS-630-6T-2	553	738	109	698	462	160	96	513	644	14
CMRS-630-6T-3	553	738	109	698	462	160	96	513	644	14
CMRS-710-4T-15	607	815	67	775	511	160	123	567	719	14
CMRS-710-4T-20	607	815	67	775	511	160	123	567	719	14
CMRS-710-6T-4	607	815	67	775	511	160	123	567	719	14
CMRS-710-6T-5.5	607	815	67	775	511	160	123	567	719	14
CMRS-800-4T-25	689	921	135	871	574	200	119	639	808	14
CMRS-800-4T-30	689	921	135	871	574	200	119	639	808	14
CMRS-800-6T-7.5	689	921	135	871	574	200	119	639	808	14
CMRS-800-6T-10	689	921	135	871	574	200	119	639	808	14

Dimensiones mm

SISTEMA
4

CMRS 900...1400

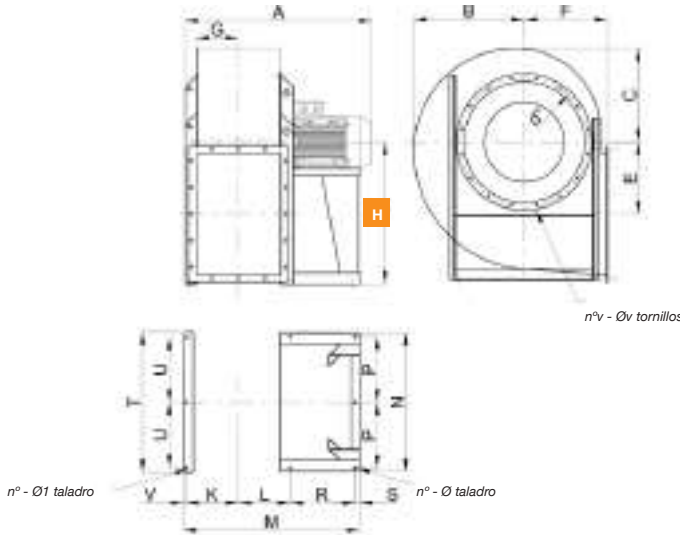

BOCA DE IMPULSIÓN

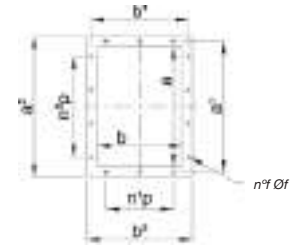

ORIENTACIONES

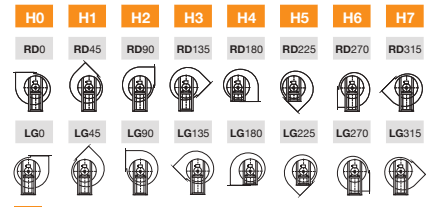

H * La medida de la cota H (distancia entre el suelo y el eje) varía según las orientaciones

MOD.	Frame	A*	B	C	E	F	G	HO-1-2-3	H4-5	H6-7	L	K	M*	N	P	R*	S	T	U
CMRS-900	225 S/4	1425	835	710	543	630	322	850	630	1060	368	363	1257	1021	480	460	40	1100	480
CMRS-900	225 M/4	1425	835	710	543	630	322	850	630	1060	368	363	1257	1021	480	460	40	1100	480
CMRS-900	160 L/6	1275	835	710	543	630	322	850	630	1060	368	363	1132	1021	480	335	40	1100	480
CMRS-900	180 L/6	1315	835	710	543	630	322	850	630	1060	368	363	1177	1021	480	380	40	1100	480
CMRS-1000	250 M/4	1585	930	795	610	710	360	950	710	1180	407	396	1414	1120	530	520	50	1230	530
CMRS-1000	280 S/4	1710	930	795	610	710	360	950	710	1180	407	396	1534	1120	530	640	50	1230	530
CMRS-1000	200 LR/6	1460	930	795	610	710	360	950	710	1180	407	396	1334	1120	530	440	50	1230	530
CMRS-1000	200 L/6	1460	930	795	610	710	360	950	710	1180	407	396	1334	1120	530	440	50	1230	530
CMRS-1120	225 M/6	1615	1045	895	683	800	403	1060	800	1320	480	446	1450	1260	590	420	50	1370	590
CMRS-1120	250 M/6	1690	1045	895	683	800	403	1060	800	1320	480	446	1520	1260	590	490	50	1370	590
CMRS-1250	280 M/6	1912	1175	1005	770	900	452	1180	900	1500	528	495	1707	1390	655	610	50	1540	655
CMRS-1250	315 S/6	1935	1175	1005	770	900	452	1180	900	1500	528	495	1797	1390	655	670	50	1540	655
CMRS-1400	315 M/6	2145	1305	1115	854	1000	506	1320	1000	1700	603	549	1906	1530	725	640	60	1690	725
CMRS-1400	315 M/6	2145	1305	1115	854	1000	506	1320	1000	1700	603	549	1906	1530	725	640	60	1690	725

BOCA IMPULSIÓN

MOD.	V	n°	Φ	Φ'	d'	n°v	Φv	a	b	a'	b'	a²	b²	n1p	n2p	n°f	Φf	kg	WD²
CMRS-900	26	5+3	19	19	958	16	M10	898	638	968	708	1018	758	3-200	4-200	18	14	630	47
CMRS-900	26	5+3	19	19	958	16	M10	898	638	968	708	1018	758	3-200	4-200	18	14	650	47
CMRS-900	26	5+3	19	19	958	16	M10	898	638	968	708	1018	758	3-200	4-200	18	14	460	47
CMRS-900	26	5+3	19	19	958	16	M10	898	638	968	708	1018	758	3-200	4-200	18	14	500	47
CMRS-1000	41	5+3	19	19	1067	24	M10	1007	715	1077	785	1127	835	3-200	4-200	18	14	830	77,8
CMRS-1000	41	5+3	19	19	1067	24	M10	1007	715	1077	785	1127	835	3-200	4-200	18	14	940	77,8
CMRS-1000	41	5+3	19	19	1067	24	M10	1007	715	1077	785	1127	835	3-200	4-200	18	14	700	77,8
CMRS-1000	41	5+3	19	19	1067	24	M10	1007	715	1077	785	1127	835	3-200	4-200	18	14	720	77,8
CMRS-1120	54	5+3	24	24	1200	24	M10	1130	801	1210	881	1270	941	3-200	5-200	20	18	1080	135
CMRS-1120	54	5+3	24	24	1200	24	M10	1130	801	1210	881	1270	941	3-200	5-200	20	18	1200	135
CMRS-1250	54	5+3	24	24	1337	24	M10	1267	898	1347	978	1407	1038	4-200	6-200	24	18	1460	240
CMRS-1250	54	5+3	24	24	1337	24	M10	1267	898	1347	978	1407	1038	4-200	6-200	24	18	1600	240
CMRS-1400	54	5+3	24	24	1491	32	M10	1421	1007	1501	1087	1561	1147	4-200	6-200	24	18	2050	415
CMRS-1400	54	5+3	24	24	1491	32	M10	1421	1007	1501	1087	1561	1147	4-200	6-200	24	18	2110	415

* Para construcciones a "ALTA TEMP" cotas "A-M-R" + 50 mm.
Kg = Peso ventilador con motor.
WD² = Momento de inercia del rodete, expresado en Kg x m²

LARGE SERIES

Dimensiones mm

CMRS-X 250...500

SISTEMA 1

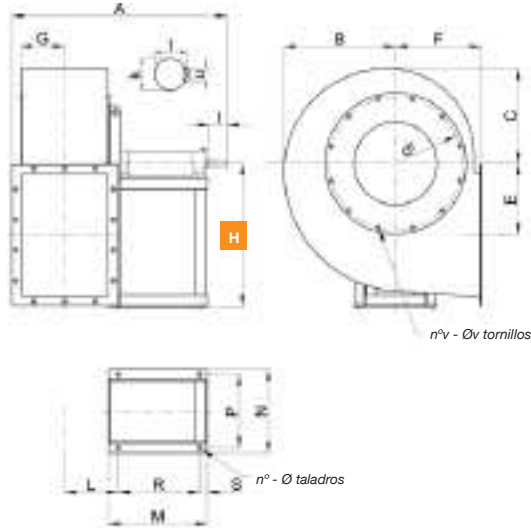

SISTEMA 12

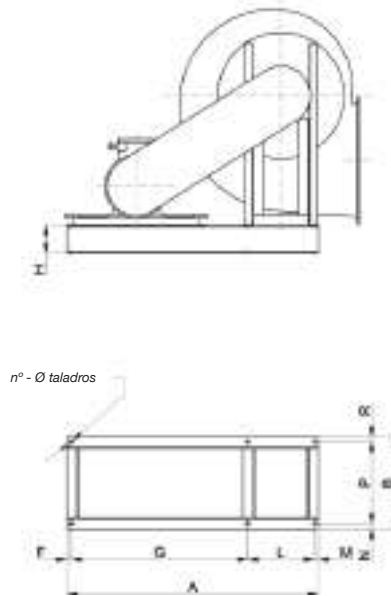

MOD.	A*	B	C	E	F	G	H0	H1	H2	H3
CMRS-250	500	240	210	150	195	93	315	315	315	315
CMRS-280	605	265	225	171	200	104	375	375	375	375
CMRS-310	630	300	225	196	225	116	400	400	400	400
CMRS-350	860	335	285	215	255	130	450	450	450	450
CMRS-400	1000	380	320	243	285	146	500	500	500	500
CMRS-450	1025	425	360	273	320	163	560	560	560	560
CMRS-500	1075	470	405	301	360	182	600	600	600	600

MOD.	A	B*	H	F	G	L	M	N
CMRS-250	700	185	80	15	480	190	15	20
CMRS-280	895	265	100	20	630	230	15	25
CMRS-310	895	265	100	20	630	230	15	25
CMRS-350	980	450	120	20	630	310	20	25
CMRS-400	1020	530	120	20	650	330	20	25
CMRS-450	1175	530	120	25	800	330	20	25
CMRS-500	1265	495	160	25	830	385	25	30

MOD.	H4	H5	H6	H7	L	M*	N	P	R*	S
CMRS-250	195	195	315	315	144	220	214	190	145	25
CMRS-280	200	200	375	375	155	290	254	230	215	25
CMRS-310	225	225	400	400	167	290	254	230	215	25
CMRS-350	255	255	450	450	181	480	350	310	400	30
CMRS-400	285	285	500	500	198	560	370	330	480	30
CMRS-450	320	320	560	560	215	560	370	330	480	30
CMRS-500	360	360	600	600	234	520	438	385	430	80

MOD.	P*	R	n°	Φ	kg
CMRS-250	145	20	6	10	19
CMRS-280	215	25	6	12	30
CMRS-310	215	25	6	12	30
CMRS-350	400	25	6	14	45
CMRS-400	480	25	6	14	50
CMRS-450	480	25	6	14	55
CMRS-500	430	35	6	17	78

MOD.	n°	Φ	k	l	t	u	d ¹	n°v	Φv	kg	WD ²
CMRS-250	4	10	19 k6	40	21,5	6	292	8	M8	30	0,15
CMRS-280	4	12	24 k6	50	27	8	332	8	M8	40	0,2
CMRS-310	4	12	24 k6	50	27	8	366	8	M8	45	0,35
CMRS-350	4	14	28 k6	60	31	8	405	8	M8	75	0,6
CMRS-400	4	14	38 k6	80	41	10	448	8	M8	85	1,1
CMRS-450	4	14	38 k6	80	41	10	497	8	M8	100	2
CMRS-500	4	17	42 k6	110	45	12	551	12	M8	140	3,3

* Para construcciones a "ALTA TEMP." en modelo de 250 a 500, cotas "B-P" + 50mm.
Kg = Peso de la base soporte

* Para construcciones a "ALTA TEMP." en modelo de 250 a 500, cotas "A-M-R" + 50mm.
Kg = Peso ventilador sin motor.
WD² = Momento de inercia del rodete, expresado en Kg x m²

BOCA DE IMPULSIÓN



BOCA IMPULSIÓN

MOD.	a	b	a ¹	b ¹	a ²	b ²	n°p	n°p'	n°f	Φf
CMRS-250	256	183	292	219	326	253	1-112	2-112	10	12
CMRS-280	288	205	332	249	368	285	1-125	2-125	10	12
CMRS-310	322	229	366	273	402	309	1-125	2-125	10	12
CMRS-350	361	256	405	300	441	336	1-125	2-125	10	12
CMRS-400	404	288	448	332	484	368	2-125	3-125	14	12
CMRS-450	453	322	497	366	533	402	2-125	3-125	14	12
CMRS-500	507	361	551	405	587	441	2-125	3-125	14	12

ORIENTACIONES

H0	H1	H2	H3	H4	H5	H6	H7
RD0	RD45	RD90	RD135	RD180	RD225	RD270	RD315
LG0	LG45	LG90	LG135	LG180	LG225	LG270	LG315

* La medida de la cota H (distancia entre el suelo y el eje) varía según las orientaciones

LARGE SERIES

Dimensiones mm

CMRS-X 560...800

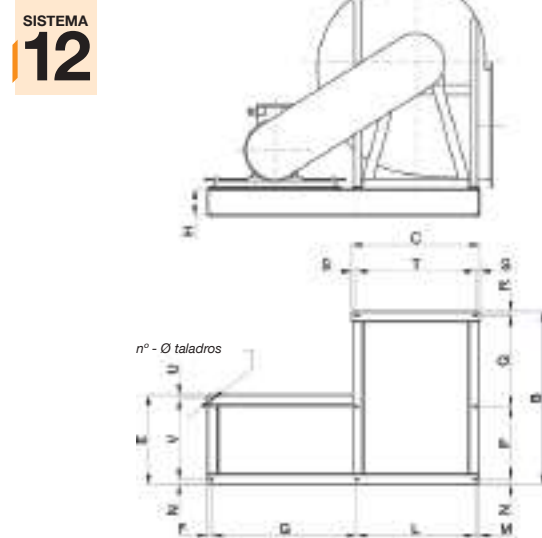
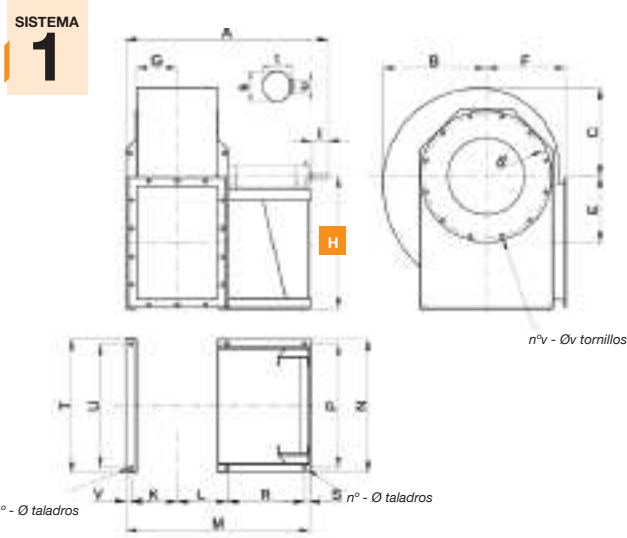

MOD.	A*	B	C	E	F	G	H0	H1	H2	H3	H4	H5
CMRS-560	1135	525	445	331	400	204	670	670	670	670	400	400
CMRS-630	1185	590	505	375	450	228	750	750	750	750	450	450
CMRS-710	1340	670	570	431	500	255	670	670	670	670	500	500
CMRS-800	1450	745	635	482	560	286	750	750	750	750	560	560

MOD.	A	B*	C	E	H	F	G	L	M	N
CMRS-560	1415	975	690	510	160	25	735	630	25	30
CMRS-630	1610	1025	760	530	160	25	860	700	25	30
CMRS-710	1980	1175	920	690	180	30	1150	770	30	30
CMRS-800	2070	1285	1000	690	180	30	1150	860	30	30

MOD.	H6	H7	L	K	M*	N	P	R*	S	T	U	V
CMRS-560	670	670	255	237	985	683	630	430	40	690	630	23
CMRS-630	750	750	279	263	1035	753	700	430	40	760	700	23
CMRS-710	850	850	306	294	1184	831	770	515	40	845	770	29
CMRS-800	950	950	337	325	1296	921	860	565	40	935	860	29

MOD.	P*	Q	R	S	T	U	V	n°	Φ	kg
CMRS-560	430	492	23	30	630	25	455	8	17	110
CMRS-630	430	542	23	30	700	25	475	8	17	120
CMRS-710	515	600	30	75	770	30	630	10	19	172
CMRS-800	565	662	28	70	860	30	630	10	19	180

MOD.	n°	Φ	k	l	t	u	d ¹	n°v	Φv	kg	WD ²	
CMRS-560	4+2	17	48	k6	110	51,5	14	629	12	M8	180	5,2
CMRS-630	4+2	17	48	k6	110	51,5	14	698	12	M8	220	8,5
CMRS-710	5+3	19	48	k6	110	51,5	14	775	16	M10	280	15,5
CMRS-800	5+3	19	55	m6	110	59	16	861	16	M10	350	28,5

* Para construcciones a "ALTA TEMP." en modelo de 560 a 630, cotas "B-P" + 50mm.
Kg = Peso de la base soporte

* Para construcciones a "ALTA TEMP." en modelo de 560 a 630, cotas "A-M-R" + 50mm.
Kg = Peso ventilador sin motor.
WD² = Momento de inercia del rodete, expresado en Kg x m²

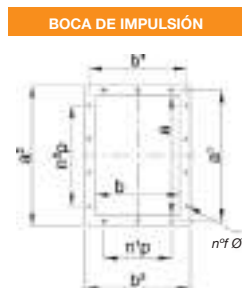

BOCA IMPULSIÓN

MOD.	a	b	a'	b'	a''	b''	n°p	n°p'	n°f	Φf
CMRS-560	569	404	629	464	669	504	2-160	3-160	14	14
CMRS-630	638	453	698	513	738	553	2-160	3-160	14	14
CMRS-710	715	507	775	567	815	607	2-160	4-160	16	14
CMRS-800	801	569	871	639	921	689	2-200	3-200	14	14

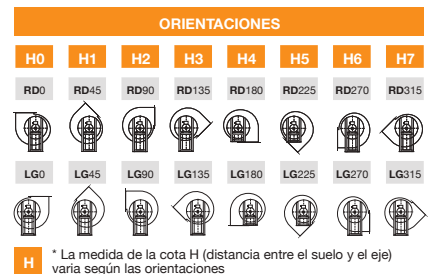

LARGE SERIES

Dimensiones mm

CMRS-X 900...2000

SISTEMA 1

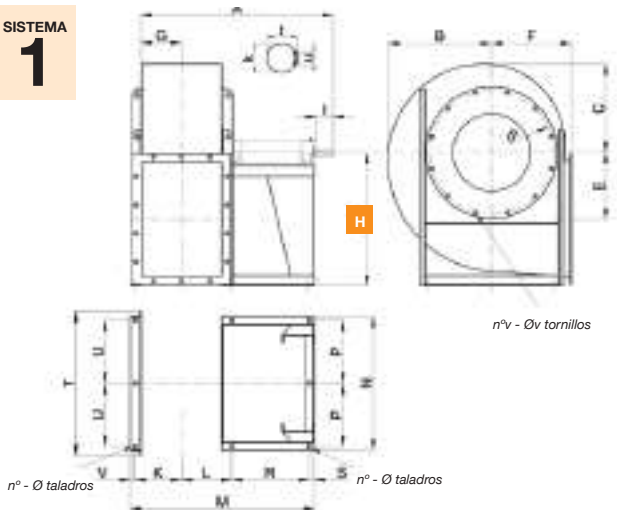

MOD.	A*	B	C	E	F	G	H0	H1	H2	H3	H4	H5
CMRS-900	1515	835	710	543	630	322	850	850	850	850	630	630
CMRS-1000	1690	930	795	610	710	360	950	950	950	950	710	710
CMRS-1120	1980	1045	895	683	800	403	1060	1060	1060	1060	800	800
CMRS-1250	2080	1175	1005	770	900	452	1180	1180	1180	1180	900	900
CMRS-1400	2270	1305	1115	854	1000	506	1320	1320	1120	1120	1000	1000
CMRS-1600	2580	1535	1245	956	1120	568	1500	1500	1250	1250	1120	1120
CMRS-1800	2790	1705	1390	1066	1250	636	1650	1550	1400	1320	1250	1250
CMRS-2000	2940	1920	1555	1195	1400	713	1850	1700	1600	1450	1400	1400

MOD.	H6	H7	L	K	M*	N	P	R*	S	T	U	V
CMRS-900	1060	1060	368	363	1362	1021	480	565	40	1100	480	26
CMRS-1000	1180	1180	407	396	1499	1120	530	605	50	1230	530	41
CMRS-1120	1320	1320	480	446	1790	1260	590	760	50	1370	590	54
CMRS-1250	1500	1500	528	495	1887	1390	655	760	50	1540	655	54
CMRS-1400	1700	1500	603	549	2046	1530	725	780	60	1690	725	54
CMRS-1600	1900	1600	684	621	2349	1720	820	920	60	1950	820	64
CMRS-1800	2120	1800	753	699	2486	1910	915	920	60	2150	915	54
CMRS-2000	2360	2000	830	776	2670	2110	1015	920	60	2390	1015	84

MOD.	n°	Φ	k	l	t	u	d'	n°v	Φv	kg	WD ²
CMRS-900	5+3	19	55 m6	110	59	16	958	16	M10	430	47
CMRS-1000	5+3	19	65 m6	140	69	18	1067	24	M10	550	77,8
CMRS-1120	5+3	24	75 m6	140	79,5	20	1200	24	M10	870	135
CMRS-1250	5+3	24	75 m6	140	79,5	20	1337	24	M10	1100	240
CMRS-1400	5+3	24	80 m6	170	85	22	1491	32	M10	1580	415
CMRS-1600	5+3	28	90 m6	170	95	25	1663	32	M12	2000	700
CMRS-1800	5+3	28	100 j6	210	106	28	1856	32	M12	2780	1310
CMRS-2000	5+3	28	100 j6	210	106	28	2073	32	M12	3400	2050

* Para construcciones a "ALTA TEMP." en modelo de 710 a 900, cotas "A-M-R" + 50mm.
Kg = Peso ventilador sin motor.
WD² = Momento de inercia del rodete, expresado en Kg x m²

SISTEMA 12

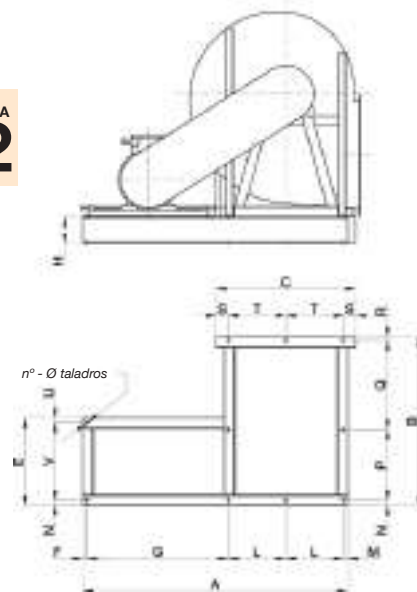

MOD.	A	B*	C	E	H	F	G	L	M	N
CMRS-900	2200	1355	1100	750	180	30	1180	480	30	30
CMRS-1000	2300	1475	1230	755	180	30	1180	530	30	35
CMRS-1120	2470	1755	1370	830	180	35	1220	590	35	35
CMRS-1250	2600	1850	1540	830	180	35	1220	655	35	35
CMRS-1400	3150	2000	1690	990	180	35	1630	725	35	35
CMRS-1600	3340	2295	1950	990	180	35	1630	820	35	35
CMRS-1800	3590	2435	2150	1090	180	30	1700	915	30	30
CMRS-2000	3800	2600	2390	1100	180	35	1700	1015	35	35

MOD.	P*	Q	R	S	T	U	V	n°	Φ	kg
CMRS-900	565	731	29	70	480	30	690	10	19	195
CMRS-1000	605	803	32	85	530	30	690	10	19	270
CMRS-1120	760	926	34	95	590	35	760	10	24	305
CMRS-1250	760	1023	32	115	655	35	760	10	24	320
CMRS-1400	780	1152	33	120	725	35	920	10	24	375
CMRS-1600	920	1305	35	155	820	35	920	10	28	405
CMRS-1800	920	1452	33	160	915	30	1030	10	28	495
CMRS-2000	920	1606	39	180	1015	35	1030	10	28	520

* Para construcciones a "ALTA TEMP." en modelo de 710 a 900, cotas "B-P" + 50mm.
Kg = Peso de la base soporte

BOCA DE IMPULSIÓN

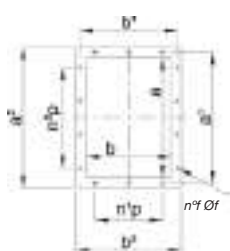

BOCA IMPULSIÓN

MOD.	a	b	a'	b'	a''	b''	n°p	n°f	Φf
CMRS-900	898	638	968	708	1018	758	3-200	4-200	18 14
CMRS-1000	1007	715	1077	785	1127	835	3-200	4-200	18 14
CMRS-1120	1130	801	1210	881	1270	941	3-200	5-200	20 18
CMRS-1250	1267	898	1347	978	1407	1038	4-200	6-200	24 18
CMRS-1400	1421	1007	1501	1087	1561	1147	4-200	6-200	24 18
CMRS-1600	1593	1130	1683	1220	1753	1290	5-200	7-200	28 22
CMRS-1800	1786	1267	1876	1357	1946	1427	6-200	8-200	32 22
CMRS-2000	2003	1421	2093	1511	2163	1581	6-200	9-200	34 22

ORIENTACIONES

H0	H1	H2	H3	H4	H5	H6	H7
RD0	RD45	RD90	RD135	RD180	RD225	RD270	RD315
LG0	LG45	LG90	LG135	LG180	LG225	LG270	LG315

H * La medida de la cota H (distancia entre el suelo y el eje) varía según las orientaciones

LARGE SERIES

Accesorios

Contrabrida aspiración

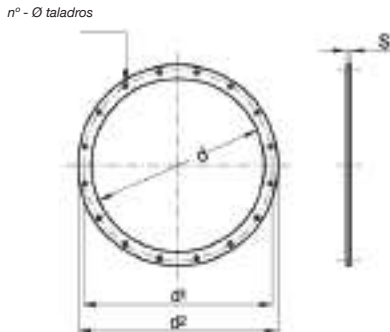

MOD.	d	d'	d''	n°	Φ	S	kg
CMRS-250	255	292	325	8	11	4	1
CMRS-280	286	332	366	8	11	5	1,6
CMRS-310	321	366	401	8	11	5	1,8
CMRS-350	361	405	441	8	11	5	2
CMRS-400	406	448	486	12	11	5	2,2
CMRS-450	456	497	536	12	11	5	2,5
CMRS-500	506	551	586	12	11	5	2,7
CMRS-560	568	629	668	12	11	6	4,6
CMRS-630	638	698	738	12	11	6	5
CMRS-710	718	775	818	16	13	6	5,5
CMRS-800	808	861	908	16	13	6	7
CMRS-900	908	958	1008	16	13	6	7
CMRS-1000	1008	1067	1108	24	13	6	7,8
CMRS-1120	1130	1200	1250	24	13	8	13,8
CMRS-1250	1260	1337	1380	24	13	8	15,5
CMRS-1400	1410	1491	1530	32	13	8	17
CMRS-1600	1610	1663	1730	32	15	8	19,5
CMRS-1800	1810	1856	1930	32	15	8	21,7
CMRS-2000	2010	2073	2130	32	15	8	24

Contrabrida impulsión

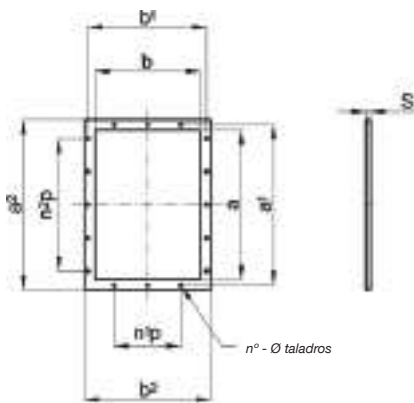

Modelo	a	b	a'	b'	a''	b''	n°p	n2p	n°	Φ	s	kg
CMRS-250	256	183	292	219	326	253	1-112	2-112	10	12	4	1,1
CMRS-280	288	205	332	249	368	285	1-125	2-125	10	12	5	1,8
CMRS-310	322	229	366	273	402	309	1-125	2-125	10	12	5	2
CMRS-350	361	256	405	300	441	336	1-125	2-125	10	12	5	2,2
CMRS-400	404	288	448	332	484	368	2-125	3-125	14	12	5	2,4
CMRS-450	453	322	497	366	533	402	2-125	3-125	14	12	5	2,7
CMRS-500	507	361	551	405	587	441	2-125	3-125	14	12	5	3
CMRS-560	569	404	629	464	669	504	2-160	3-160	14	14	6	5
CMRS-630	638	453	698	513	738	553	2-160	3-160	14	14	6	5,6
CMRS-710	715	507	775	567	815	607	2-160	4-160	16	14	6	6,2
CMRS-800	801	569	871	639	921	689	2-200	3-200	14	14	8	11,2
CMRS-900	898	638	968	708	1018	758	3-200	4-200	18	14	8	12,5
CMRS-1000	1007	715	1077	785	1127	835	3-200	4-200	18	14	8	14
CMRS-1120	1130	801	1210	881	1270	941	3-200	5-200	20	18	8	18
CMRS-1250	1267	898	1347	978	1407	1038	4-200	6-200	24	18	8	20
CMRS-1400	1421	1007	1501	1087	1561	1147	4-200	6-200	24	18	8	22
CMRS-1600	1593	1130	1683	1220	1753	1290	5-200	7-200	28	22	8	28,5
CMRS-1800	1786	1267	1876	1357	1946	1427	6-200	8-200	32	22	8	31,5
CMRS-2000	2003	1421	2093	1511	2163	1581	6-200	9-200	34	22	8	35

Red protección en aspiración

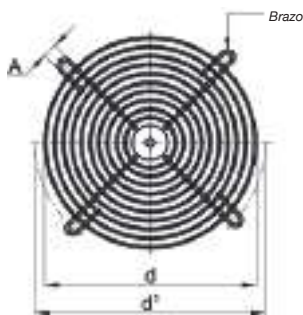

MOD.	d	d'	A	n°	kg
CMRS-250	255	292	11	4	0,3
CMRS-280	286	332	11	4	0,35
CMRS-310	321	366	11	4	0,4
CMRS-350	361	405	11	8	0,7
CMRS-400	406	448	11	8	0,8
CMRS-450	456	497	11	8	0,9
CMRS-500	506	551	11	8	0,9
CMRS-560	568	629	11	8	1,2
CMRS-630	638	698	11	8	1,5
CMRS-710	718	775	13	8	2
CMRS-800	808	861	13	8	2,5
CMRS-900	908	958	13	8	3
CMRS-1000	1008	1067	13	8	3,5
CMRS-1120	1130	1200	13	8	8,5
CMRS-1250	1260	1337	13	8	10
CMRS-1400	1410	1491	13	8	13
CMRS-1600	1610	1663	15	8	16
CMRS-1800	1810	1856	15	8	25
CMRS-2000	2010	2073	15	8	35

LARGE SERIES

Accesorios

Junta anti vibratoria en aspiración

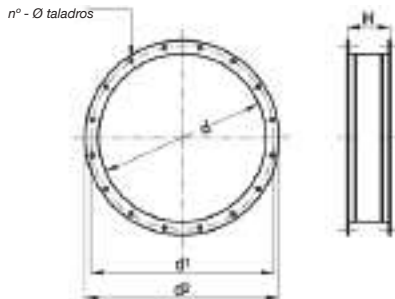

MOD.	d	d ¹	d ²	n°	Φ	H	kg
CMRS-250	255	292	325	8	11	200	2,2
CMRS-280	286	332	366	8	11	200	3,4
CMRS-310	321	366	401	8	11	200	3,8
CMRS-350	361	405	441	8	11	200	4,2
CMRS-400	406	448	486	12	11	200	4,6
CMRS-450	456	497	536	12	11	200	5,1
CMRS-500	506	551	586	12	11	200	5,6
CMRS-560	568	629	668	12	11	200	9,4
CMRS-630	638	698	738	12	11	200	10,4
CMRS-710	718	775	818	16	13	200	11,6
CMRS-800	808	861	908	16	13	200	13
CMRS-900	908	958	1008	16	13	200	14,4
CMRS-1000	1008	1067	1108	24	13	200	16
CMRS-1120	1130	1200	1250	24	13	200	29
CMRS-1250	1260	1337	1380	24	13	200	33
CMRS-1400	1410	1491	1530	32	13	200	36
CMRS-1600	1610	1663	1730	32	15	200	43
CMRS-1800	1810	1856	1930	32	15	200	47
CMRS-2000	2010	2073	2130	32	15	200	52

Junta anti vibratoria en impulsión

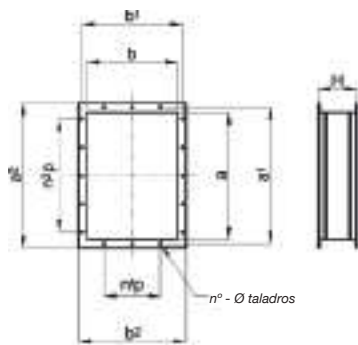

Modelo	a	b	a ¹	b ¹	a ²	b ²	n ¹ p	n ² p	n°	Φ	H	kg
CMRS-250	256	183	292	219	326	253	1-112	2-112	10	12	200	2,4
CMRS-280	288	205	332	249	368	285	1-125	2-125	10	12	200	3,8
CMRS-310	322	229	366	273	402	309	1-125	2-125	10	12	200	4,2
CMRS-350	361	256	405	300	441	336	1-125	2-125	10	12	200	4,6
CMRS-400	404	288	448	332	484	368	2-125	3-125	14	12	200	5
CMRS-450	453	322	497	366	533	402	2-125	3-125	14	12	200	5,6
CMRS-500	507	361	551	405	587	441	2-125	3-125	14	12	200	6,2
CMRS-560	569	404	629	464	669	504	2-160	3-160	14	14	200	10,2
CMRS-630	638	453	698	513	738	553	2-160	3-160	14	14	200	11,4
CMRS-710	715	507	775	567	815	607	2-160	4-160	16	14	200	12,6
CMRS-800	801	569	871	639	921	689	2-160	4-160	16	14	200	23
CMRS-900	898	638	968	708	1018	758	3-200	4-200	18	14	200	25,5
CMRS-1000	1007	715	1077	785	1127	835	3-200	4-200	18	14	200	28,5
CMRS-1120	1130	801	1210	881	1270	941	3-200	5-200	20	18	200	37
CMRS-1250	1267	898	1347	978	1407	1038	4-200	6-200	24	18	200	41
CMRS-1400	1421	1007	1501	1087	1561	1147	4-200	6-200	24	18	200	46
CMRS-1600	1593	1130	1683	1220	1753	1290	5-200	7-200	28	22	200	60
CMRS-1800	1786	1267	1876	1357	1946	1427	6-200	8-200	32	22	200	66
CMRS-2000	2003	1421	2093	1511	2163	1581	6-200	9-200	34	22	200	73

Regulador de caudal en aspiración

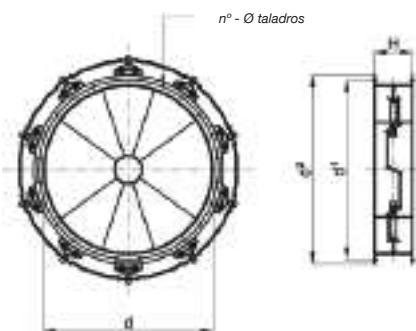

MOD.	d	d ¹	d ²	n°	Φ	H	kg
CMRS-310	321	366	401	8	11	200	24
CMRS-350	361	405	441	8	11	250	26
CMRS-400	406	448	486	12	11	250	30
CMRS-450	456	497	536	12	11	250	32
CMRS-500	506	551	586	12	11	250	45
CMRS-560	568	629	668	12	11	250	50
CMRS-630	638	698	738	12	11	300	58
CMRS-710	718	775	818	16	13	300	68
CMRS-800	808	861	908	16	13	350	87
CMRS-900	908	958	1008	16	13	350	102
CMRS-1000	1008	1067	1108	24	13	350	120
CMRS-1120	1130	1200	1250	24	13	400	150
CMRS-1250	1260	1337	1380	24	13	400	170
CMRS-1400	1410	1491	1530	32	13	400	190
CMRS-1600	1610	1663	1730	32	15	460	210
CMRS-1800	1810	1856	1930	32	15	500	250
CMRS-2000	2010	2073	2130	32	15	500	320

Accesorios

Damper de aletas contrapuestas

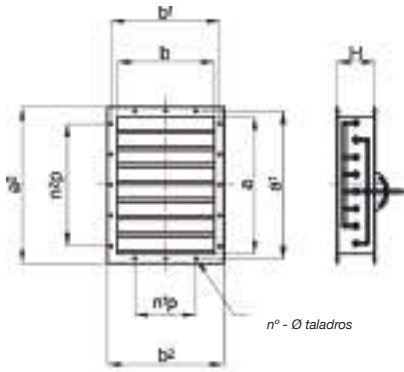

MOD.	a	b	a1	b1	a2	b2	n1p	n2p	n°	Φ	H (1)	H (2)	kg (1)	kg (2)
CMRS-310	322	229	366	273	402	309	1-125	2-125	10	12	220	250	11	12
CMRS-350	361	256	405	300	441	336	1-125	2-125	10	12	220	250	14	15
CMRS-400	404	288	448	332	484	368	2-125	3-125	14	12	220	250	18	19
CMRS-450	453	322	497	366	533	402	2-125	3-125	14	12	220	250	21	22
CMRS-500	507	361	551	405	587	441	2-125	3-125	14	12	220	250	24	25
CMRS-560	569	404	629	464	669	504	2-160	3-160	14	14	220	250	28	29
CMRS-630	638	453	698	513	738	553	2-160	3-160	14	14	220	250	32	33
CMRS-710	715	507	775	567	815	607	2-160	4-160	16	14	220	250	36	38
CMRS-800	801	569	871	639	921	689	2-200	3-200	14	14	220	250	44	46
CMRS-900	898	638	968	708	1018	758	3-200	4-200	18	14	220	250	50	52
CMRS-1000	1007	715	1077	785	1127	835	3-200	4-200	18	14	220	250	55	58
CMRS-1120	1130	801	1210	881	1270	941	3-200	5-200	20	18	220	250	81	84
CMRS-1250	1267	898	1347	978	1407	1038	4-200	6-200	24	18	220	250	92	96
CMRS-1400	1421	1007	1501	1087	1561	1147	4-200	6-200	24	18	220	250	105	110
CMRS-1600	1593	1130	1683	1220	1753	1290	5-200	7-200	28	22	220	250	140	145
CMRS-1800	1786	1267	1876	1357	1946	1427	6-200	8-200	32	22	220	250	175	180
CMRS-2000	2003	1421	2093	1511	2163	1581	6-200	9-200	34	22	220	250	235	240

(1) Hasta 300 mm H₂O.
(2) A partir de 300 mm H₂O.

Amortiguadores

TIPO 1

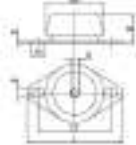

TIPO 2

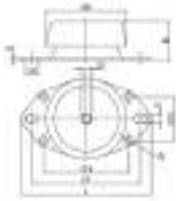

TIPO 3

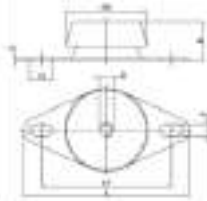

MOD.	MODELO AMORTIGUADORES	TIPO	øA	B	D	CF	CF1	CF2	F	øF1	L	M	S
CMRS-250	CF 623110	1	67	33...34	10	76,5	-	-	9	-	90,5	16	2
CMRS-280	CF 623110	1	67	33...34	10	76,5	-	-	9	-	90,5	16	2
CMRS-310	CF 623110	1	67	33...34	10	76,5	-	-	9	-	90,5	16	2
CMRS-350	CF 623110	1	67	33...34	10	76,5	-	-	9	-	90,5	16	2
CMRS-400	CF 623110	1	67	33...34	10	76,5	-	-	9	-	90,5	16	2
CMRS-450	CF 623110	1	67	33...34	10	76,5	-	-	9	-	90,5	16	2
CMRS-500	CF 623110	1	67	33...34	10	76,5	-	-	9	-	90,5	16	2
CMRS-560	CF 623110	1	67	33...34	10	76,5	-	-	9	-	90,5	16	2
CMRS-630	CF 623110	1	67	33...34	10	76,5	-	-	9	-	90,5	16	2
CMRS-710	CF 623110	1	67	33...34	10	76,5	-	-	9	-	90,5	16	2
CMRS-800	CF 924512	2	92	44...45	12	120	98	50	10,5	8,5	130	15,5	2,5
CMRS-900	CF 924512	2	92	44...45	12	120	98	50	10,5	8,5	130	15,5	2,5
CMRS-1000	CF 924512	2	92	44...45	12	120	98	50	10,5	8,5	130	15,5	2,5
CMRS-1120	CF 924512	2	92	44...45	12	120	98	50	10,5	8,5	130	15,5	2,5
CMRS-1250	CF 924512	2	92	44...45	12	120	98	50	10,5	8,5	130	15,5	2,5
CMRS-1400	CF 924512	2	92	44...45	12	120	98	50	10,5	8,5	130	15,5	2,5
CMRS-1600	CF 1204516	3	92	45	26,5	149,5			14		190	16	3,5
CMRS-1800	CF 1204516	3	92	45	26,5	149,5			14		190	16	3,5
CMRS-2000	CF 1204516	3	92	45	26,5	149,5			14		190	16	3,5

Accesorios

Silenciadores circulares

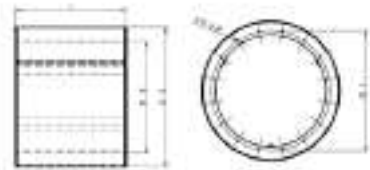

Los silenciadores se utilizan para bajar el nivel sonoro en instalaciones de acondicionamiento o ventilación, fabricados en acero cincado

- Bajo demanda: otras construcciones en diferentes materiales.

øD	øE	L	øI	F	øM
315	515	ØD,1.5ØD, 2ØD	355	8	M8
355	555	ØD,1.5ØD, 2ØD	395	8	M8
400	600	ØD,1.5ØD, 2ØD	450	8	M8
450	650	ØD,1.5ØD, 2ØD	500	8	M8
500	700	ØD,1.5ØD, 2ØD	560	12	M8
560	760	ØD,1.5ØD, 2ØD	620	12	M8
630	830	ØD,1.5ØD, 2ØD	690	12	M8
710	910	ØD,1.5ØD, 2ØD	770	16	M8
800	1000	ØD,1.5ØD, 2ØD	860	16	M8

øD	øE	L	øI	F	øM
900	1100	ØD,1.5ØD, 2ØD	970	16	M10
1000	1200	ØD,1.5ØD, 2ØD	1070	16	M10
1120	1320	ØD,1.5ØD, 2ØD	1190	20	M10
1250	1450	ØD,1.5ØD, 2ØD	1320	20	M10
1400	1600	ØD,1.5ØD, 2ØD	1470	20	M10
1500	1700	ØD,1.5ØD, 2ØD	1570	20	M10
1600	1800	ØD,1.5ØD, 2ØD	1680	24	M14
1700	1900	ØD,1.5ØD, 2ØD	1780	24	M14
1800	2000	ØD,1.5ØD, 2ØD	1880	24	M14

MOTOR DIRECTO

CAMA

Ventiladores centrífugos de media presión y simple aspiración de gran robustez con envoltente y turbina en chapa de acero Diseñados para aire con polvo



Ventilador:

- Envoltente en chapa de acero.
- Turbina a reacción en chapa de acero de gran robustez, especialmente diseñados para aire con polvo y material granulado de tamaño reducido.
- Motor directamente acoplado.
- Con trampilla de inspección y limpieza a partir del tamaño 560.
- Los tamaños superiores a 1250, se suministran con carcasa partida para facilitar el transporte.
- Carcasa soldada en continuo a partir del tamaño 710.

Motor:

- Motores con eficiencia IE3 para potencias iguales o superiores a 0,75 kW, excepto monofásicos, 2 velocidades y 8 polos.
- Motores clase F con rodamientos a bolas. Protección IP55.
- Trifásicos 230/400 V 50 Hz (hasta 4 kW) y 400/690 V 50 Hz (potencias superiores a 4 kW).
- Temperatura máxima del aire a transportar: -25 °C +90 °C.

Acabado:

- Anticorrosivo en resina de poliéster polimerizada a 190 °C, previo desengrase con tratamiento nanotecnológico libre de fosfatos.

Bajo demanda:

- Bobinados especiales para diferentes tensiones.
- Ventilador preparado para transportar aire hasta +150 °C.
- Ejecuciones especiales para temperaturas +300 °C.
- Ventilador en acero inoxidable.
- Certificación ATEX Categoría 2.
- Acoplamiento elástico sistema 8.

* Las imágenes son solo a nivel ilustrativo, el producto puede variar en función del tamaño, especificaciones y posición.

Formas constructivas motor directo

SISTEMA 4

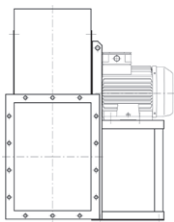

Accionamiento directo, turbina montada en el eje motor, montado sobre la silleta.

SISTEMA 5

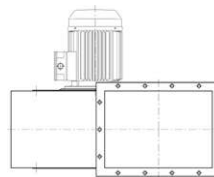

Accionamiento directo, turbina montada en el eje motor, motor de brida montado sobre la carcasa del ventilador.

SISTEMA 8

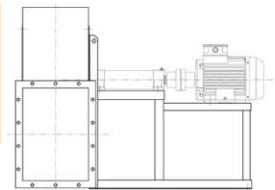

Accionamiento por acoplamiento elástico, turbina montada en el eje soporte, montado al motor mediante acoplamiento elástico. Todo montado conjuntamente sobre la silleta ventilador.

Orientaciones

RD 0 RD45 RD90 RD135 RD180 RD225 RD270 RD315

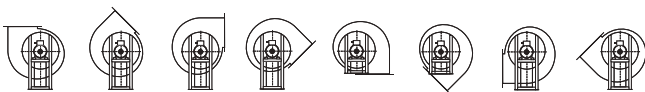

LG 0 LG45 LG90 LG135 LG180 LG225 LG270 LG315

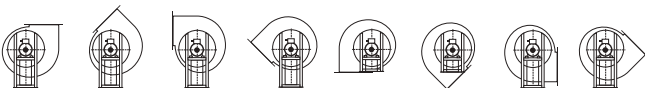

Construcción para alta temperatura



LARGE SERIES

MOTOR A TRANSMISIÓN

CAMA-X

Ventiladores de media presión accionados a transmisión, equipados con motor eléctrico, conjunto de poleas, correas y protectores normalizados según norma ISO-13857

Diseñados para aire con polvo



Ventilador:

- Envoltente en chapa de acero.
- Turbina a reacción en chapa de acero de gran robustez, especialmente diseñados para aire con polvo y material granulado de tamaño reducido.
- Motor montado sobre bancada general.
- Con trampilla de inspección y limpieza a partir del tamaño 560.
- Los tamaños superiores a 1600, se suministran con carcasa partida para facilitar el transporte.
- Carcasa soldada en continuo a partir del tamaño 710.

Motor:

- Motores con eficiencia IE3.
- Motores clase F con rodamientos a bolas. Protección IP55.
- Trifásicos 230/400 V 50 Hz (hasta 4 kW) y 400/690 V 50 Hz (potencias superiores a 4 kW).
- Temperatura máxima del aire a transportar: -25 °C +90 °C.

Acabado:

- Anticorrosivo en resina de poliéster polimerizada a 190 °C, previo desengrase con tratamiento nanotecnológico libre de fosfatos.

Bajo demanda:

- Bobinados especiales para diferentes tensiones.
- Ventilador preparado para transportar aire hasta +300 °C.
- Ventilador en acero inoxidable.
- Certificación ATEX Categoría 2.
- Acoplamiento elástico sistema 8.

* Las imágenes son solo a nivel ilustrativo, el producto puede variar en función del tamaño, especificaciones y posición.

Formas constructivas motor a transmisión

SISTEMA 12

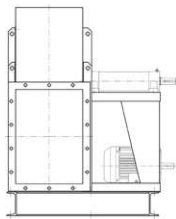

Accionamiento a transmisión, igual al SISTEMA 1, con el motor y ventilador montados en la bancada común. Posiciones de motor "W" o "Z" y excepcionalmente "X" o "Y".

SISTEMA 9

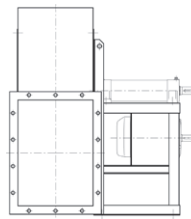

Accionamiento a transmisión, igual al SISTEMA 1, con el motor montado en el lateral de la silleta, en posición "W" o "Z".

SISTEMA 1

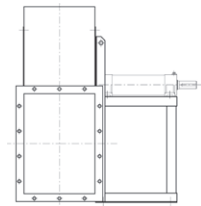

Accionamiento a transmisión, turbina montada en el eje soporte. Soporte montado sobre la silleta.

Orientaciones

RD 0 RD45 RD90 RD135 RD180 RD225 RD270 RD315

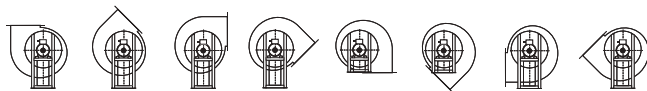

LG 0 LG45 LG90 LG135 LG180 LG225 LG270 LG315

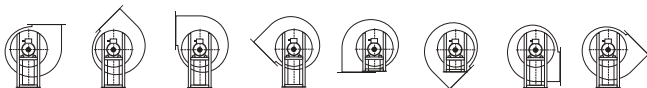

SELECCIÓN RÁPIDA SISTEMA 4

Características en impulsión

Modelo	Frame	kW abs	kW inst.	r.p.m.	dB	V m ³ /s														
						5,3	6	6,7	7,5	8,5	9,5	10,5	12	13	15	17	19	21	23	
						Pt kgf/m ² = mmH ₂ O														
CAMA 800/B	160 L/4	12	15	1465	80	170	130	95												
CAMA 800/A	180 M/4	16	18,5	1470	83	180	155	130												
CAMA 900/B	200 L/4	25	30	1470	85	310	295	275	255	225	180									
CAMA 900/A	225 S/4	35	37	1480	87	350	335	315	295	260	230									
CAMA 1000/B	225 M/4	43	45	1480	88	400	395	390	380	360	340	315	280	230						
CAMA 1000/A	250 M/4	50	55	1480	90	460	455	445	435	415	390	365	335	290						
CAMA 1120/B	280 S/4	74	75	1485	93		515	510	505	500	495	480	455	430	395	335	290			
CAMA 1120/A	280 M/4	88	90	1485	95		590	585	580	570	560	545	520	490	455	410	350			
CAMA 900/B	160 M/6	7	7,5	960	73	97	87													
CAMA 900/A	160 L/6	9	11	960	75	120	110													
CAMA 1000/B	180 L/6	12	15	970	76	160	150	140	125	100										
CAMA 1000/A	200 LA/6	16	18,5	975	78	180	172	160	150	135										
CAMA 1120/B	200 LB/6	20	22	975	81	208	205	202	200	185	165	150	130							
CAMA 1120/A	225 M/6	28	30	980	84	242	240	238	230	220	205	185	165							
CAMA 1250/B	250 M/6	35	37	980	86	285	280	275	270	270	260	245	240	235	215	190	160			
CAMA 1250/A	280 S/6	43	45	985	88	325	320	315	312	307	300	298	280	270	250	220	190			
CAMA 1400/B	280 M/6	53	55	985	90				350	345	340	338	335	325	310	290	270	260	250	
CAMA 1400/A	315 S/6	73	75	990	90				410	405	403	400	395	390	375	365	340	315	300	

Margen sobre el caudal $\pm 5\%$.
Margen del nivel sonoro $+3...5$ dB.

Curvas Características

CAMA 250

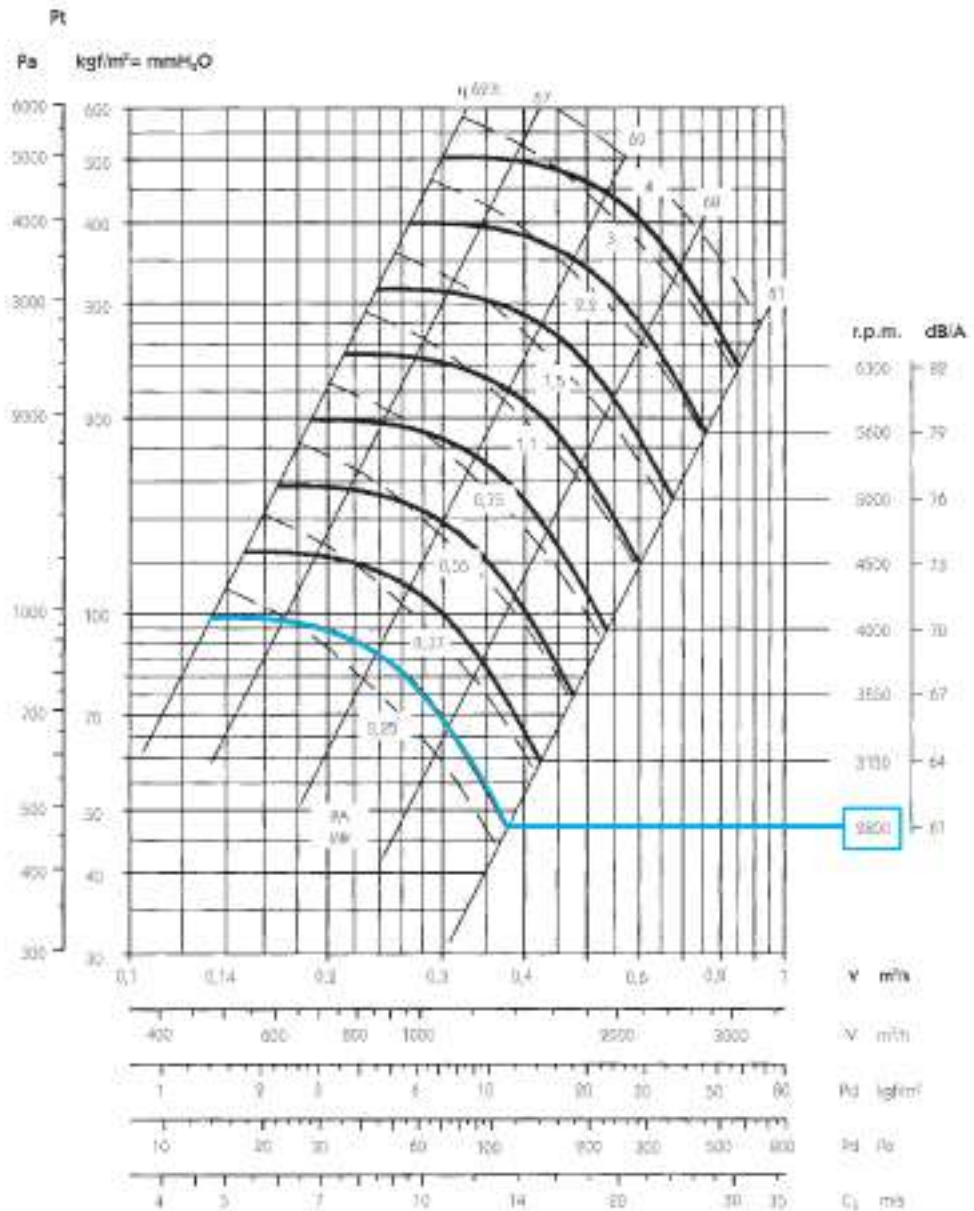

LARGE SERIES

Margen sobre el caudal $\pm 5\%$
 Margen del nivel sonoro $+3\text{ db}$
 Margen kW absorbidos $\pm 3\%$

Características en impulsión.

Rpm máximas admisibles

Clase 1	
$\leq 100\text{ }^\circ\text{C}$	5600
100 ... 200 $^\circ\text{C}$	5000
200 ... 300 $^\circ\text{C}$	4500

Rpm

Características para:
 sistema 4 y 5 en motor
 directo con 2/4/6/8 polos
 según modelo.

Curvas Características

CAMA 280

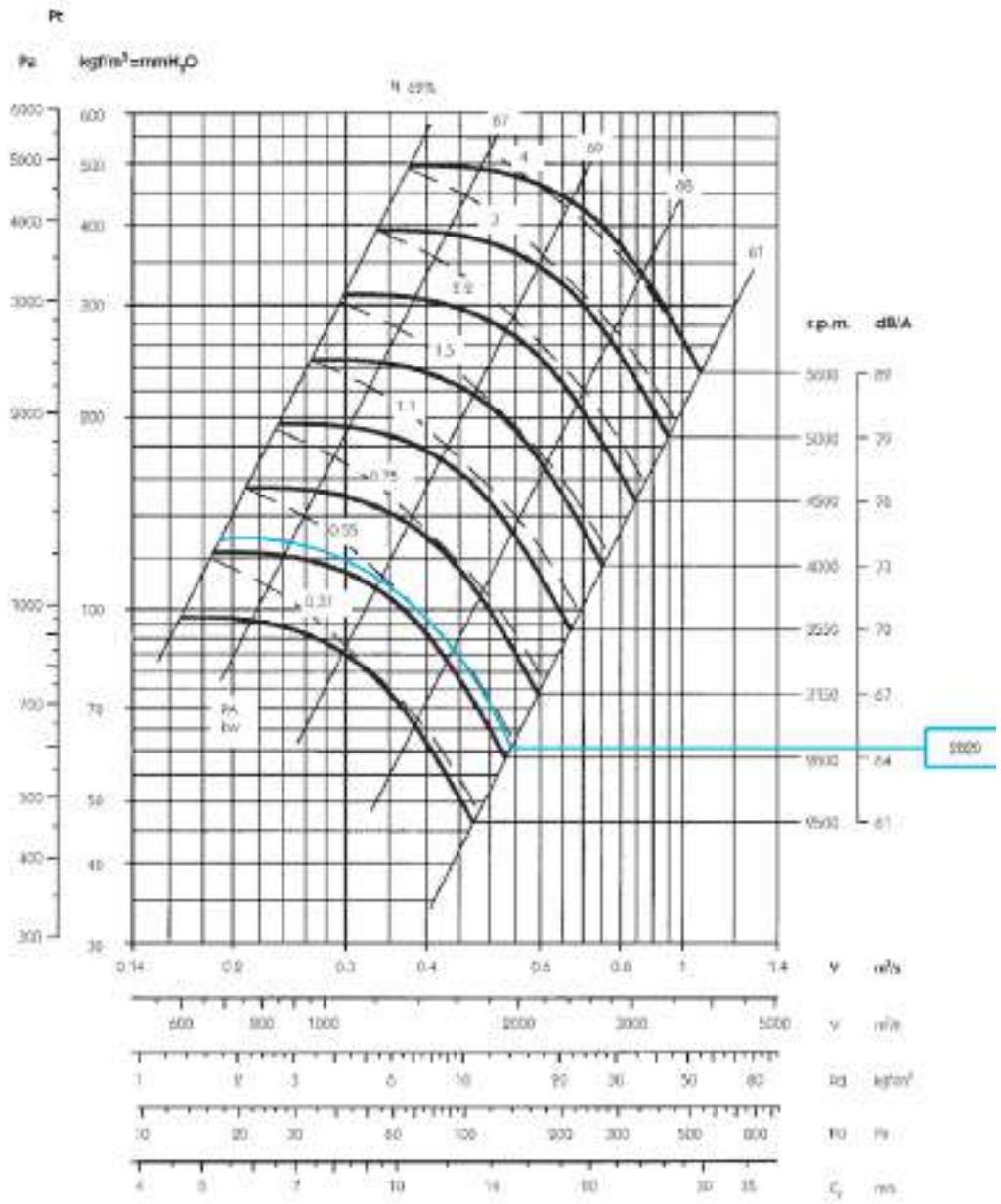

Margen sobre el caudal $\pm 5\%$
 Margen del nivel sonoro $+3\text{ db}$
 Margen kW absorbidos $\pm 3\%$

Características en impulsión.

Rpm máximas admisibles

Clase 1	
$\leq 100\text{ }^{\circ}\text{C}$	5000
100 ... 200 $^{\circ}\text{C}$	4500
200 ... 300 $^{\circ}\text{C}$	4000

Rpm

Características para:
 sistema 4 y 5 en motor
 directo con 2/4/6/8 polos
 según modelo.

Curvas Características

CAMA 310

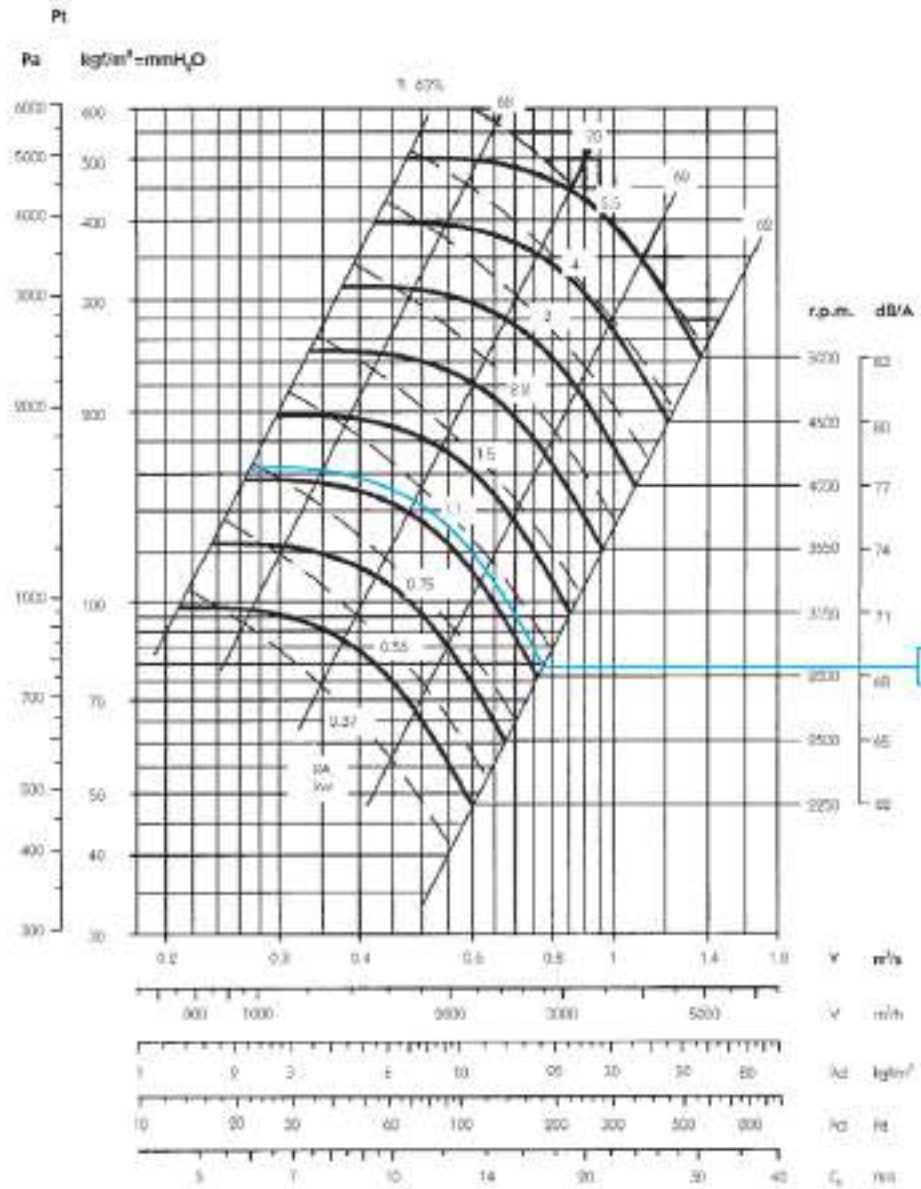

LARGE SERIES

Margen sobre el caudal ± 5 %
 Margen del nivel sonoro +3 db
 Margen kW absorbidos ± 3%

Características en impulsión.

Rpm máximas admisibles

Clase 1	
≤ 100 °C	4500
100 ... 200 °C	4000
200 ... 300 °C	3550

Rpm

Características para:
 sistema 4 y 5 en motor
 directo con 2/4/6/8 polos
 según modelo.

Curvas Características

CAMA 350

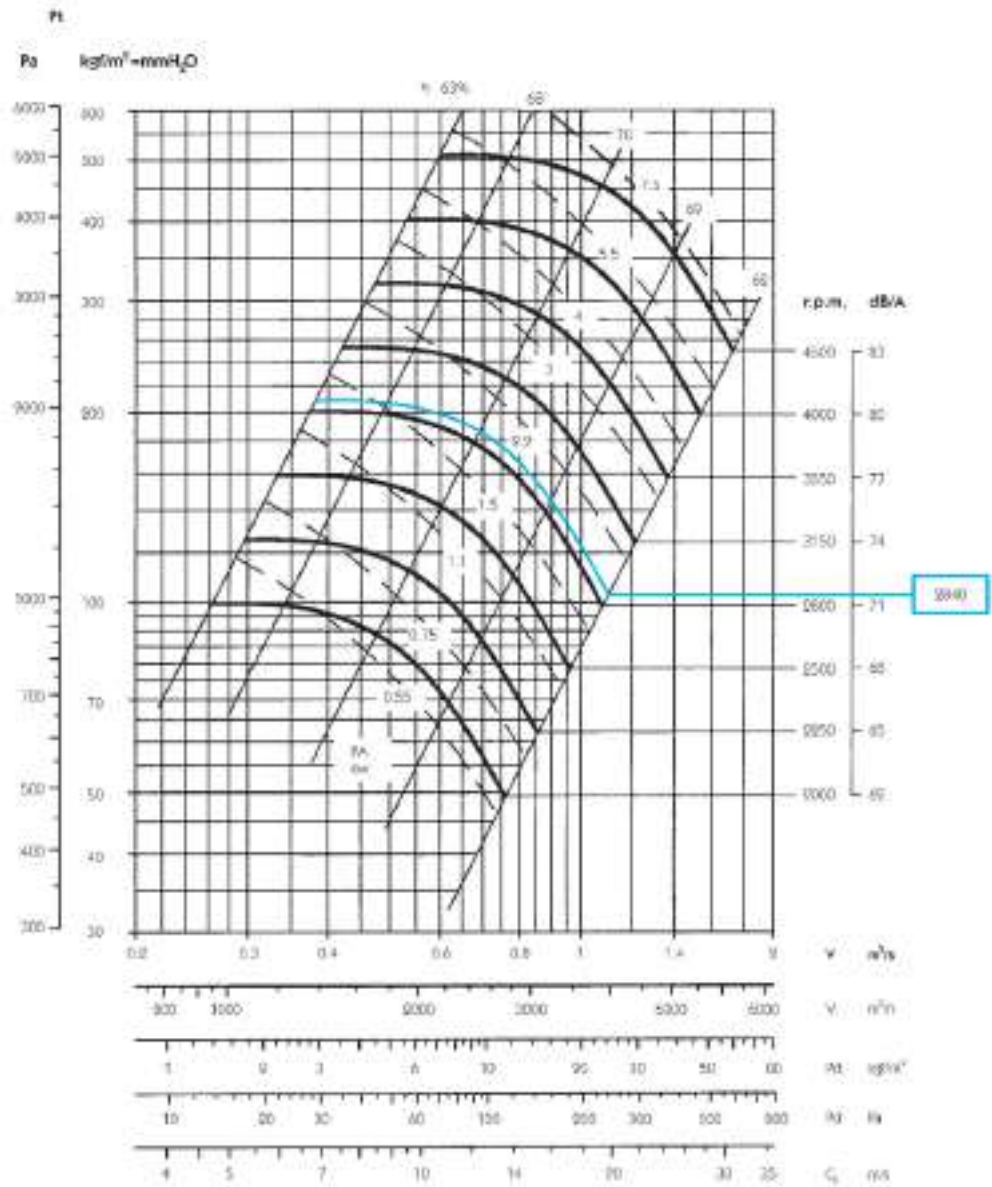

Margen sobre el caudal $\pm 5\%$
 Margen del nivel sonoro $+3$ db
 Margen kW absorbidos $\pm 3\%$
 Características en impulsión.

Rpm máximas admisibles

Clase 1	
≤ 100 °C	4000
100 ... 200 °C	3550
200 ... 300 °C	3150

Rpm

Características para:
 sistema 4 y 5 en motor
 directo con 2/4/6/8 polos
 según modelo.

Curvas Características

CAMA 400

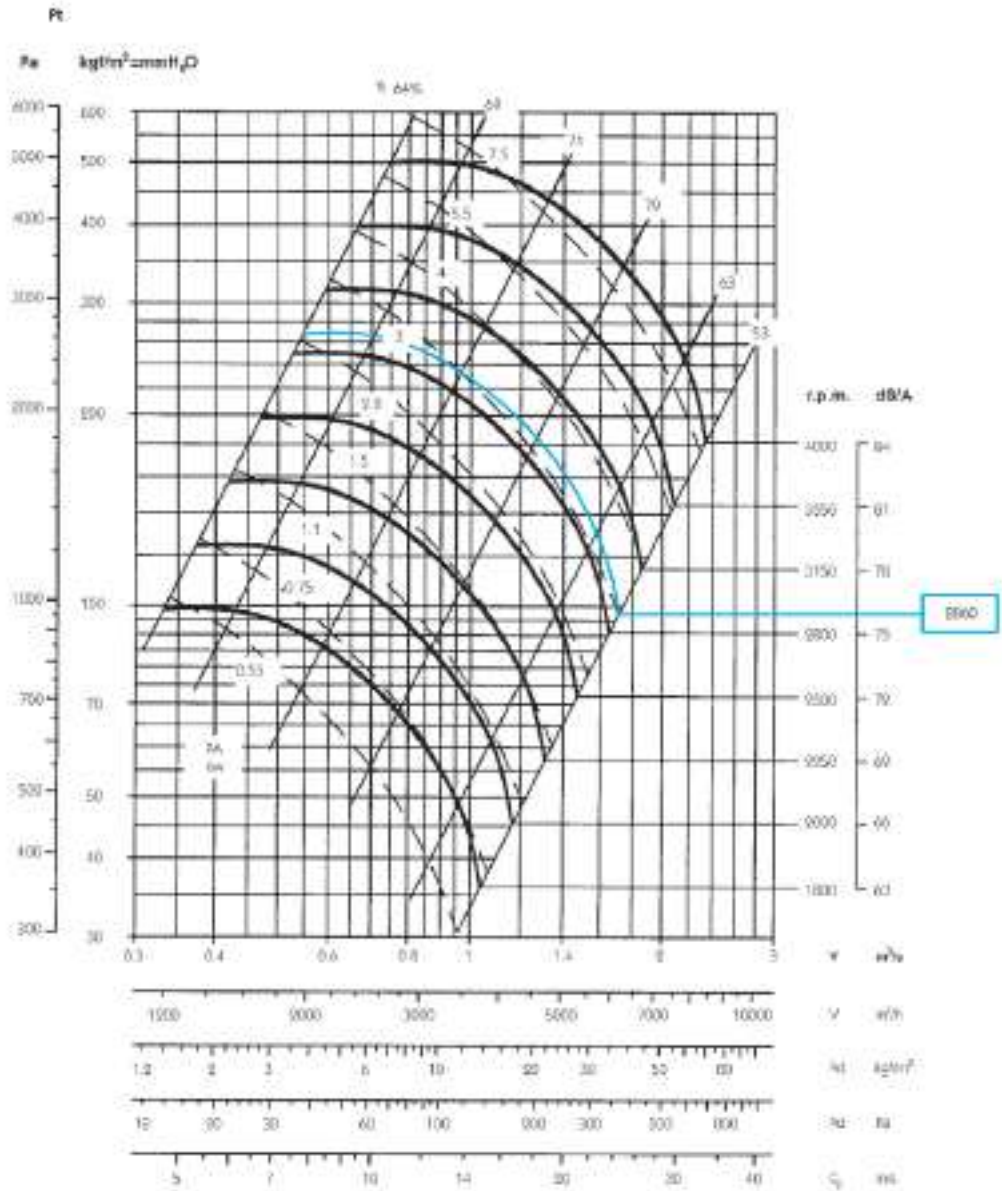

LARGE SERIES

Margen sobre el caudal ± 5 %
 Margen del nivel sonoro +3 db
 Margen kW absorbidos ± 3%

Características en impulsión.

Rpm máximas admisibles

Clase 1	
≤ 100 °C	3550
100 ... 200 °C	3150
200 ... 300 °C	2800

Rpm

Características para:
 sistema 4 y 5 en motor
 directo con 2/4/6/8 polos
 según modelo.

Curvas Características

CAMA 450

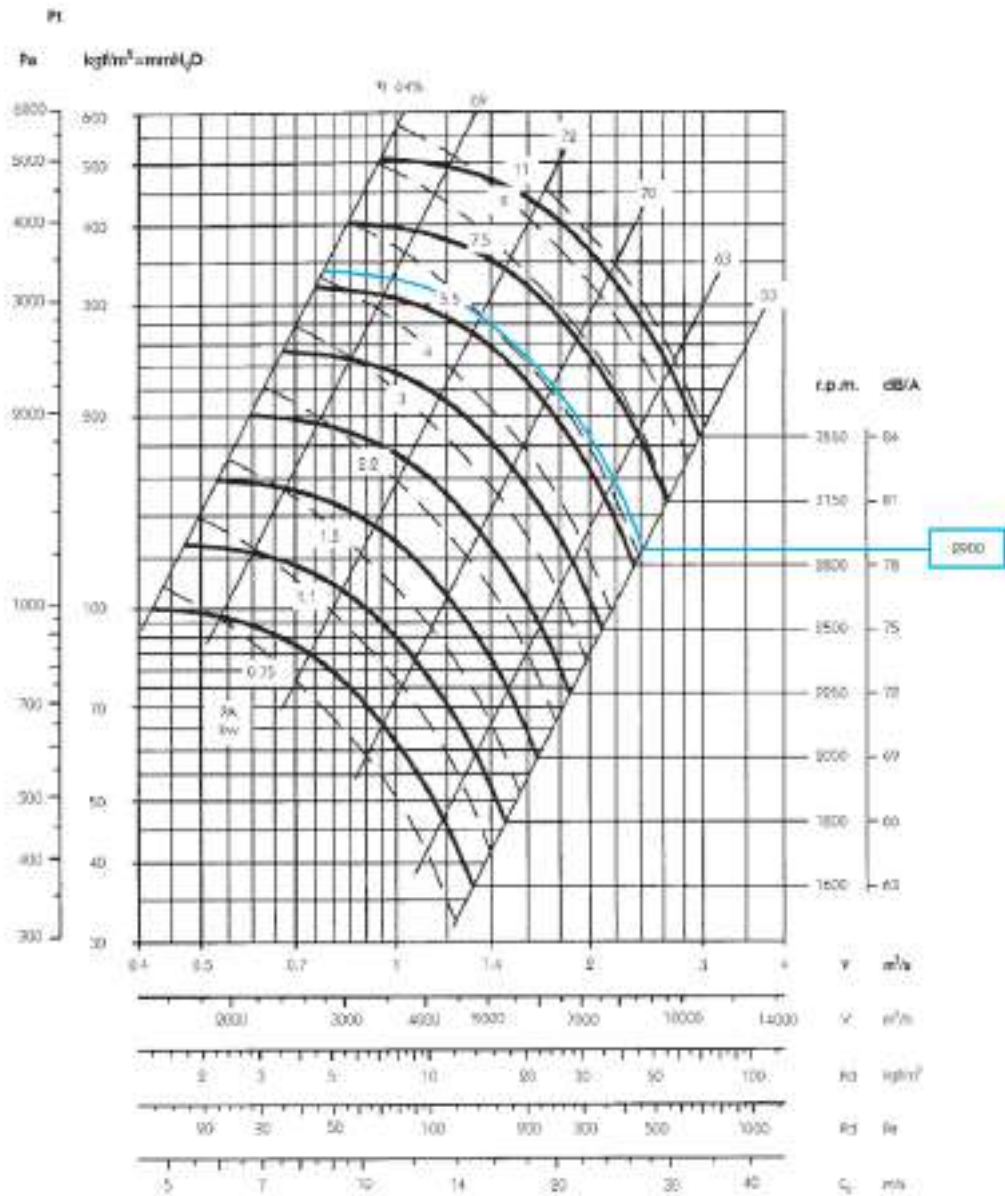

Margen sobre el caudal $\pm 5\%$
 Margen del nivel sonoro $+3\text{ db}$
 Margen kW absorbidos $\pm 3\%$
 Características en impulsión.

Rpm máximas admisibles

Clase 1	
$\leq 100\text{ }^\circ\text{C}$	3150
100 ... 200 $^\circ\text{C}$	2800
200 ... 300 $^\circ\text{C}$	2500

Rpm Características para:
 sistema 4 y 5 en motor
 directo con 2/4/6/8 polos
 según modelo.

Curvas Características

CAMA 500

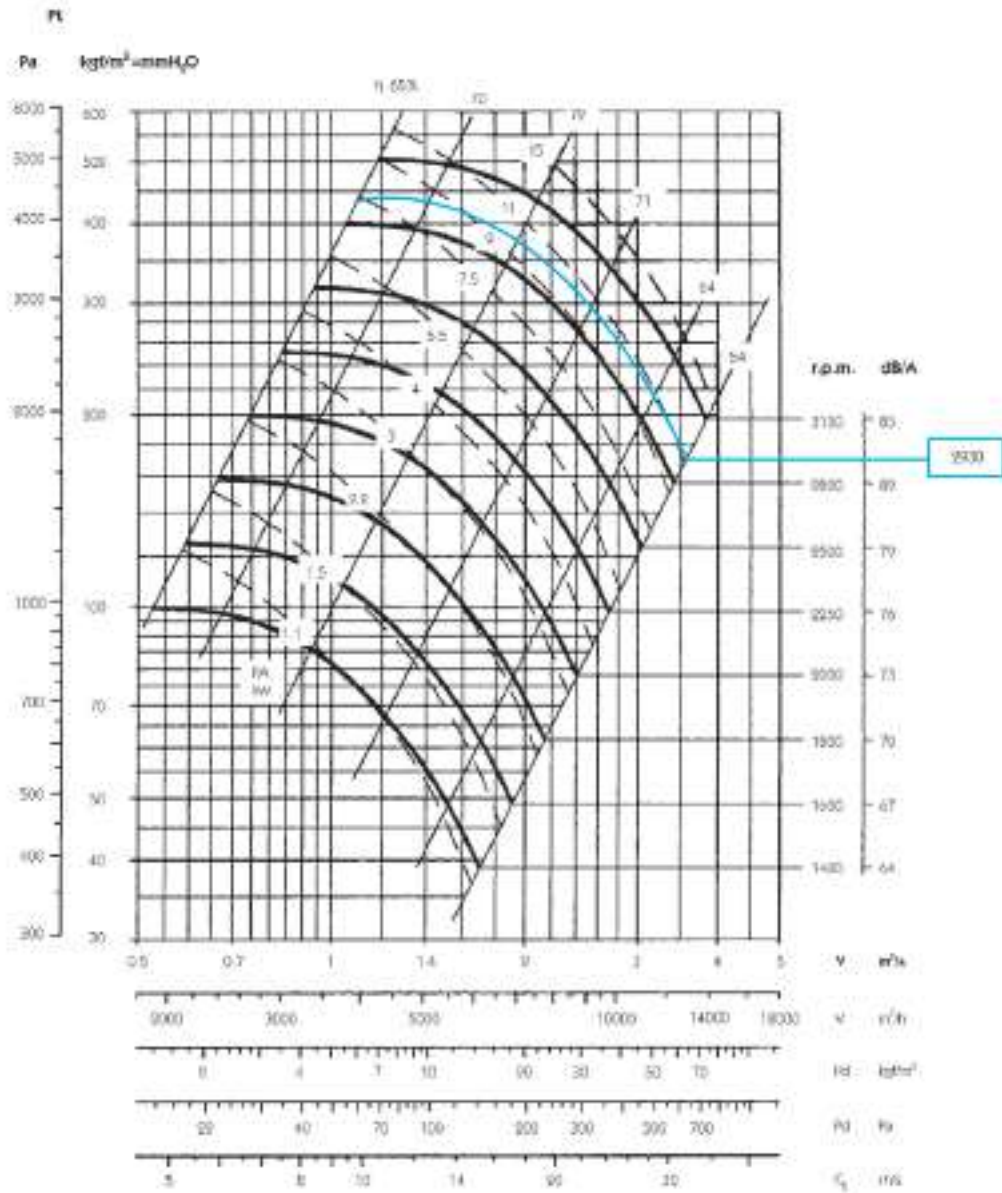

LARGE SERIES

Margen sobre el caudal $\pm 5\%$
 Margen del nivel sonoro $+3$ db
 Margen kW absorbidos $\pm 3\%$

Características en impulsión.

Rpm máximas admisibles

Clase 1	
$\leq 100\text{ }^{\circ}\text{C}$	2800
100 ... 200 $^{\circ}\text{C}$	2500
200 ... 300 $^{\circ}\text{C}$	2250

Rpm

Características para:
 sistema 4 y 5 en motor
 directo con 2/4/6/8 polos
 según modelo.

Curvas Características

CAMA 560

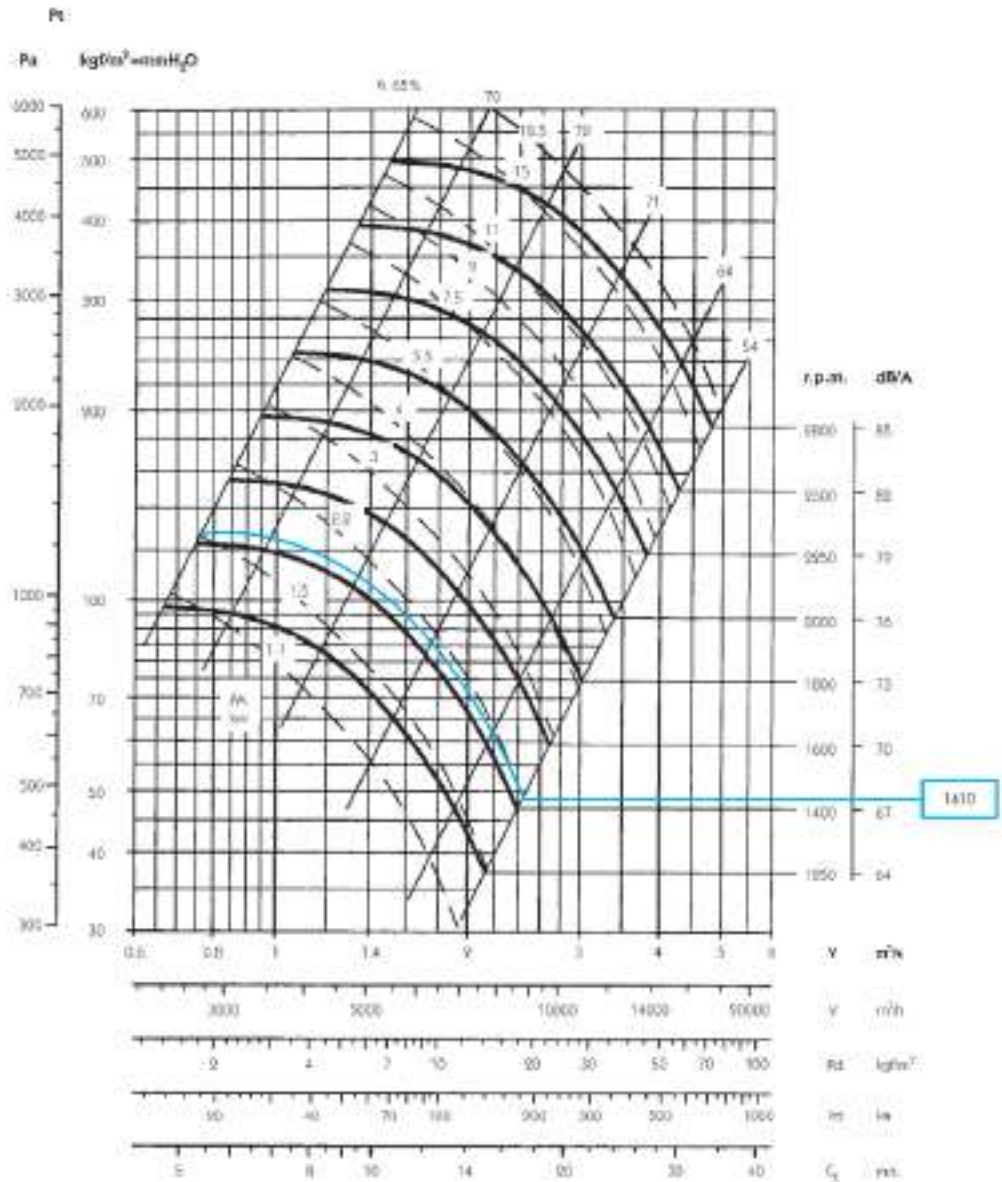

LARGE SERIES

Margen sobre el caudal $\pm 5\%$
 Margen del nivel sonoro $+3\text{ dB}$
 Margen kW absorbidos $\pm 3\%$
 Características en impulsión.

Rpm máximas admisibles

Clase 1	
$\leq 100\text{ }^\circ\text{C}$	2500
100 ... 200 $^\circ\text{C}$	2250
200 ... 300 $^\circ\text{C}$	2000

Rpm Características para:
 sistema 4 y 5 en motor
 directo con 2/4/6/8 polos
 según modelo.

Curvas Características

CAMA 630

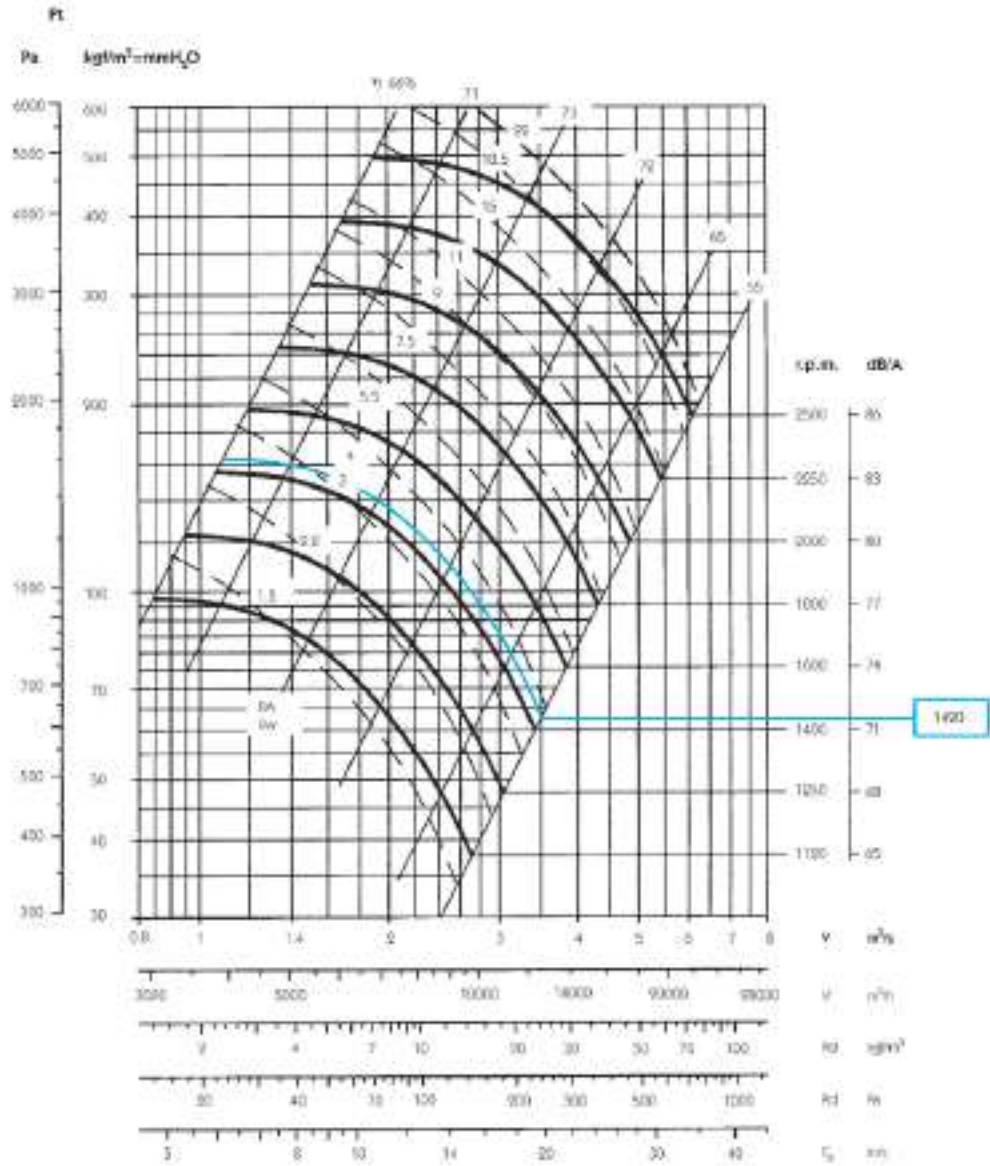

LARGE SERIES

Margen sobre el caudal ± 5 %
 Margen del nivel sonoro +3 db
 Margen kW absorbidos ± 3%

Características en impulsión.

Rpm máximas admisibles

Clase 1	
≤ 100 °C	2250
100 ... 200 °C	2000
200 ... 300 °C	1800

Rpm

Características para:
 sistema 4 y 5 en motor
 directo con 2/4/6/8 polos
 según modelo.

Curvas Características

CAMA 710

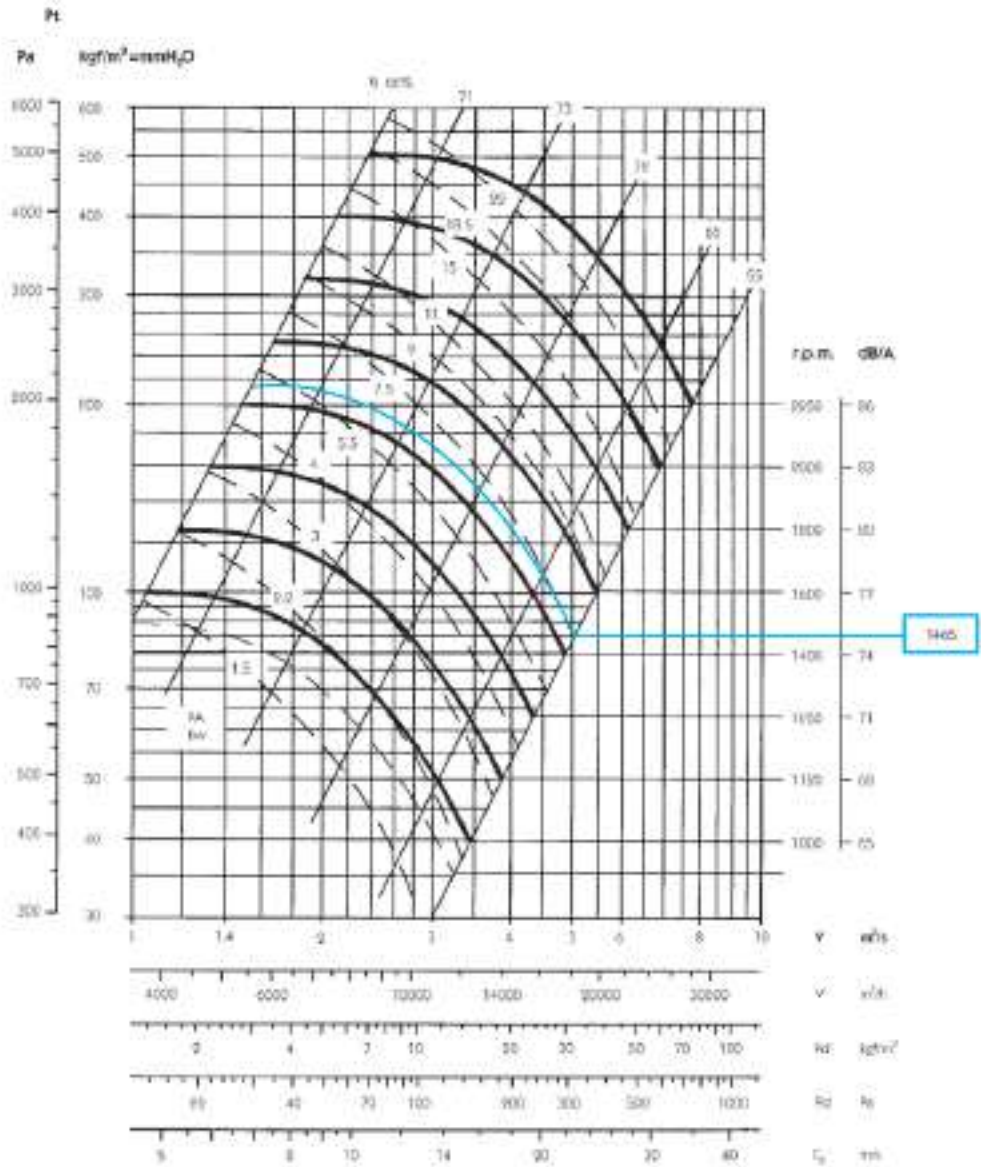

Margen sobre el caudal $\pm 5\%$
 Margen del nivel sonoro $+3\text{ db}$
 Margen kW absorbidos $\pm 3\%$

Características en impulsión.

Rpm máximas admisibles

Clase 1	
$\leq 100\text{ }^\circ\text{C}$	2000
100 ... 200 $^\circ\text{C}$	1800
200 ... 300 $^\circ\text{C}$	1600

Rpm

Características para:
 sistema 4 y 5 en motor
 directo con 2/4/6/8 polos
 según modelo.

Curvas Características

CAMA 800

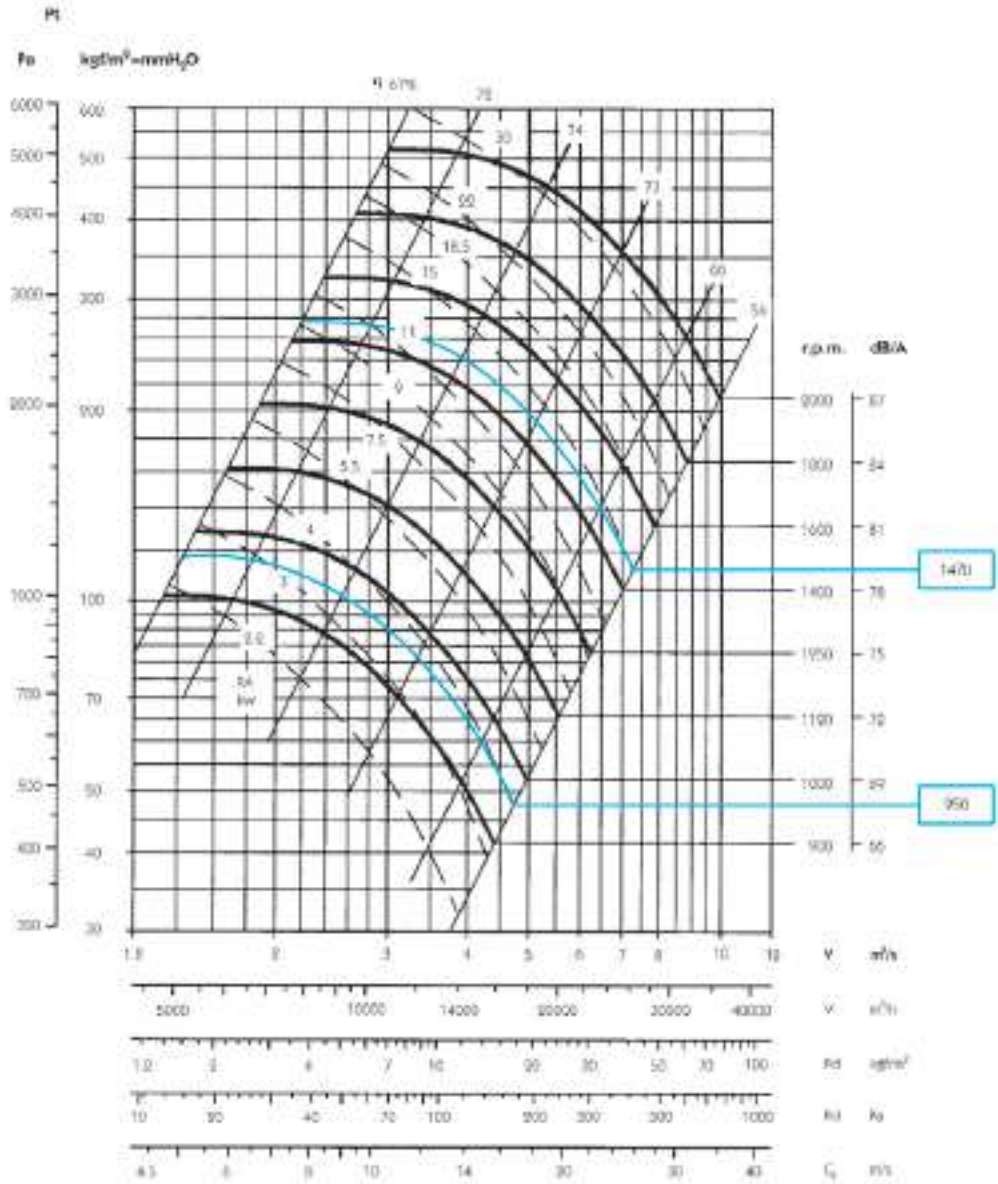

LARGE SERIES

Margen sobre el caudal $\pm 5\%$
 Margen del nivel sonoro $+3\text{ dB}$
 Margen kW absorbidos $\pm 3\%$

Características en impulsión.

Rpm máximas admisibles

Clase 1	
$\leq 100\text{ }^\circ\text{C}$	1800
100 ... 200 $^\circ\text{C}$	1600
200 ... 300 $^\circ\text{C}$	1400

Rpm

Características para:
 sistema 4 y 5 en motor
 directo con 2/4/6/8 polos
 según modelo.

Curvas Características

CAMA 900

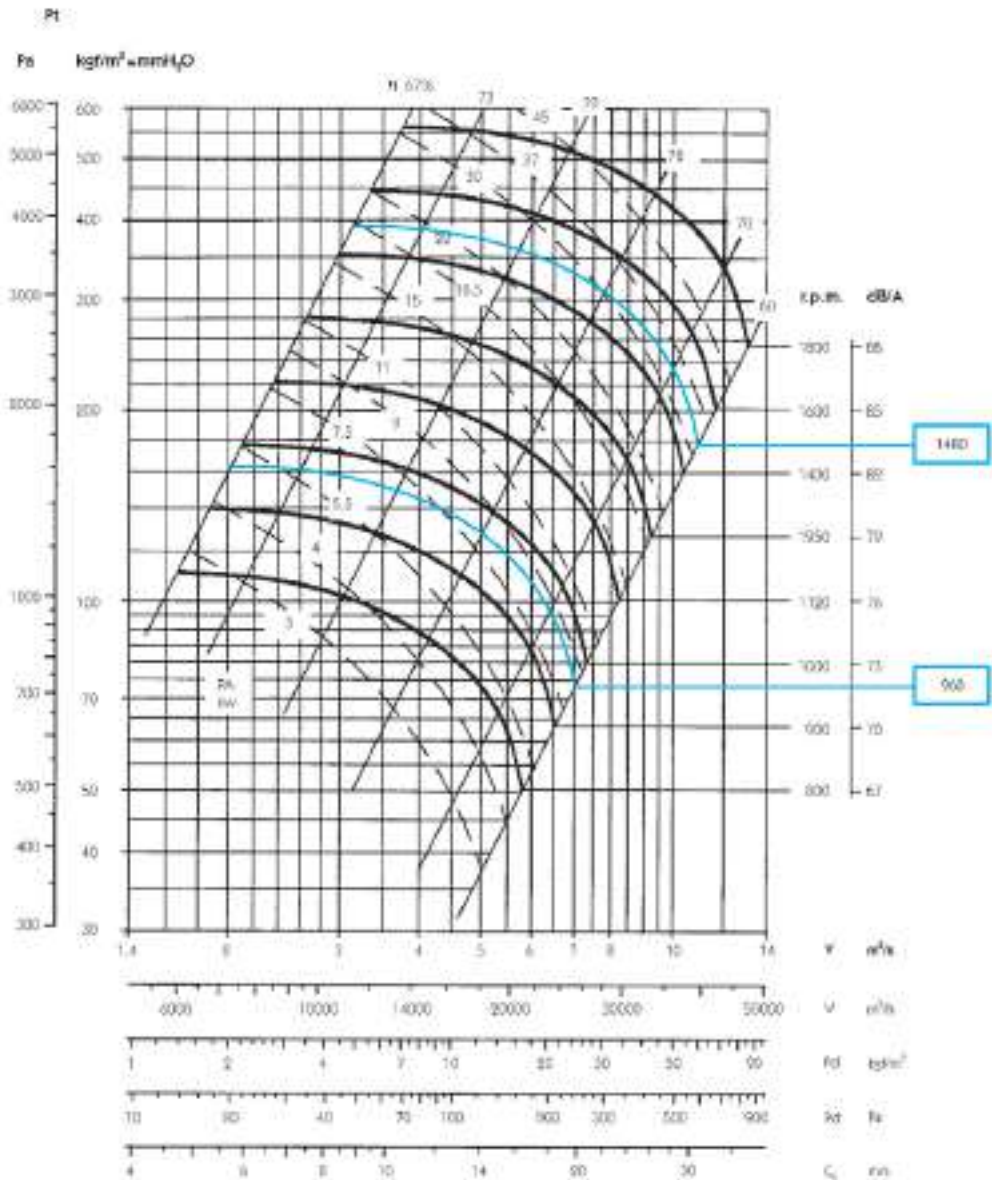

Margen sobre el caudal $\pm 5\%$
 Margen del nivel sonoro $+3\text{ dB}$
 Margen kW absorbidos $\pm 3\%$

Características en impulsión.

Rpm máximas admisibles

Clase 1	
$\leq 100\text{ }^{\circ}\text{C}$	1600
100 ... 200 $^{\circ}\text{C}$	1400
200 ... 300 $^{\circ}\text{C}$	1250

Rpm

Características para:
 sistema 4 y 5 en motor
 directo con 2/4/6/8 polos
 según modelo.

Curvas Características

CAMA 1000

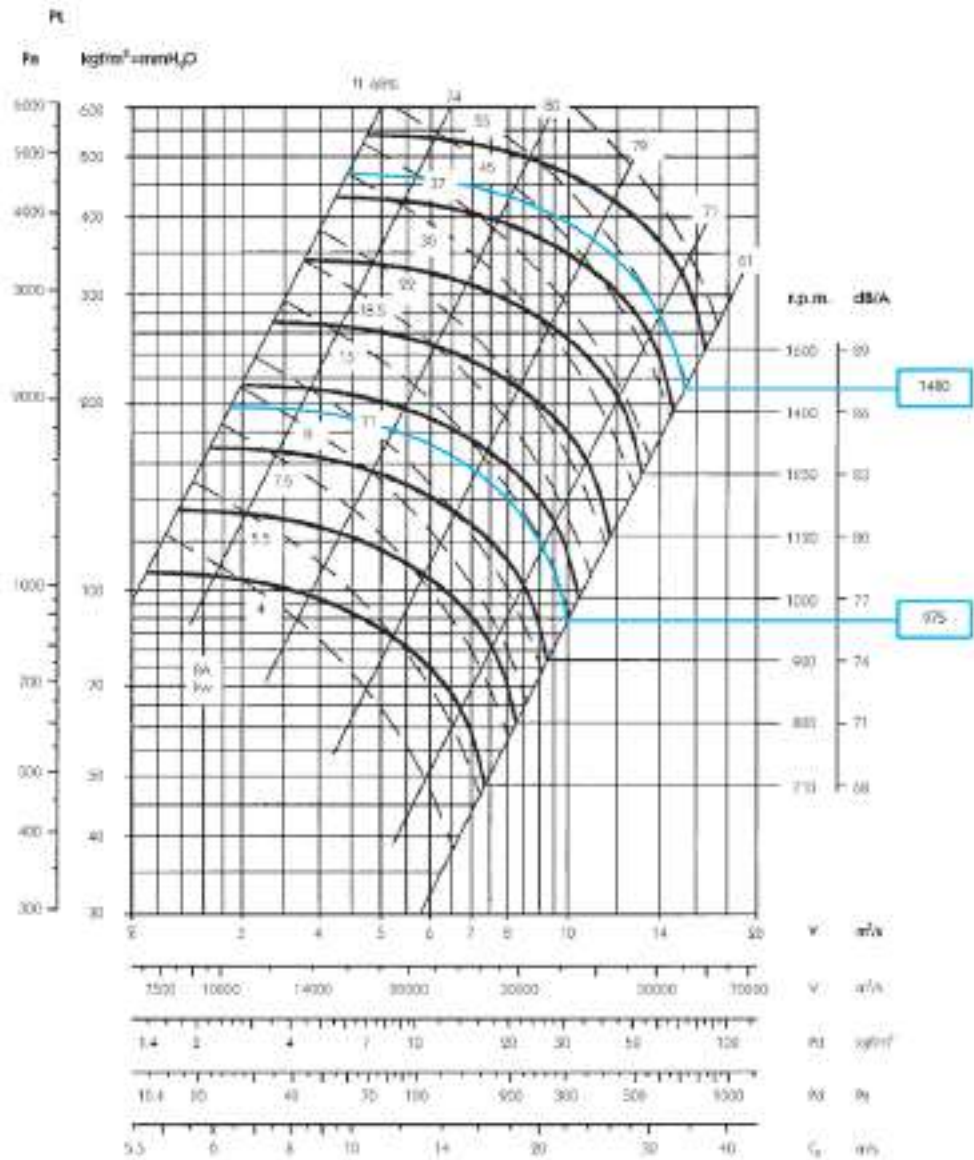

LARGE SERIES

Margen sobre el caudal $\pm 5\%$
 Margen del nivel sonoro $+3\text{ db}$
 Margen kW absorbidos $\pm 3\%$
 Características en impulsión.

Rpm máximas admisibles

Clase 1	
$\leq 100\text{ }^\circ\text{C}$	1400
100 ... 200 $^\circ\text{C}$	1250
200 ... 300 $^\circ\text{C}$	1120

Rpm Características para:
 sistema 4 y 5 en motor
 directo con 2/4/6/8 polos
 según modelo.

Curvas Características

CAMA 1120

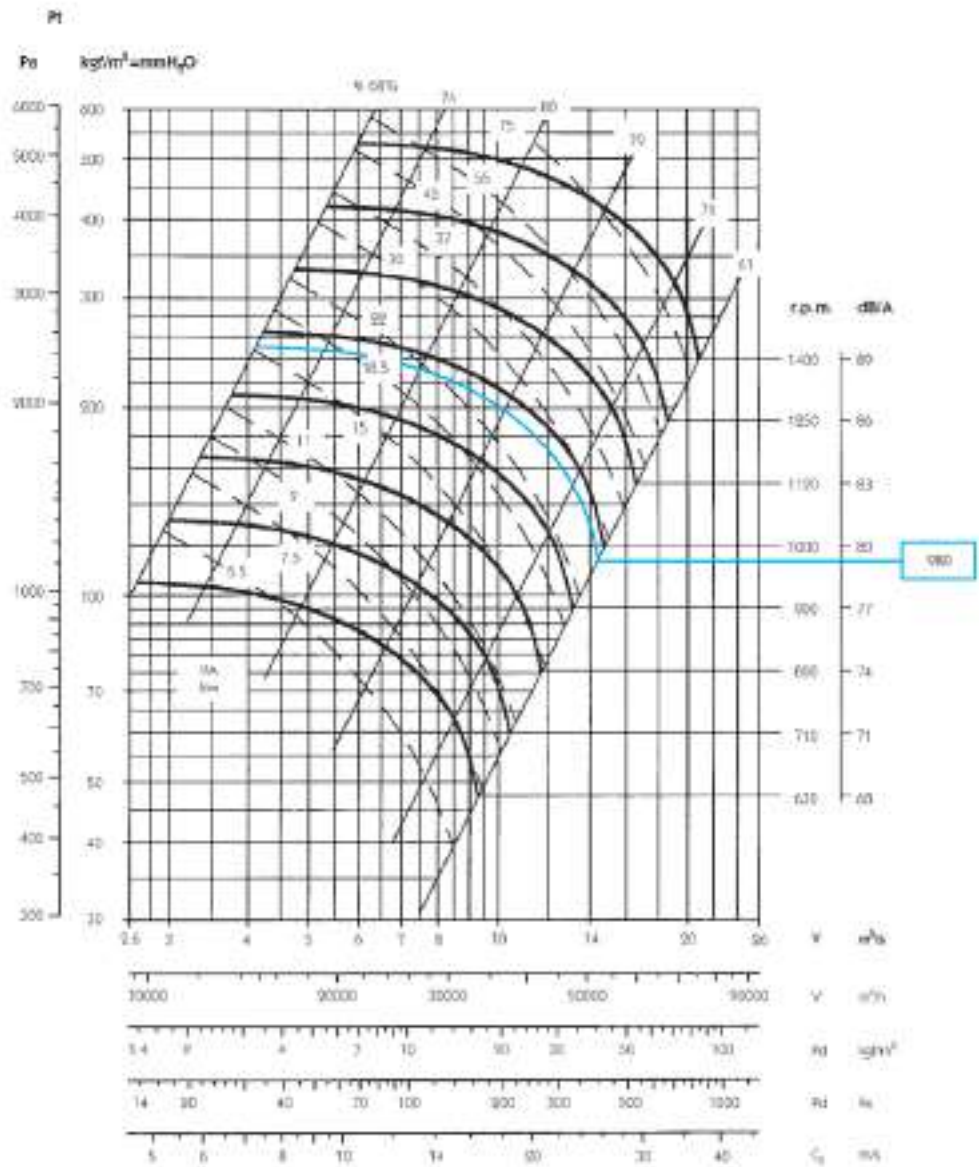

Margen sobre el caudal $\pm 5\%$
 Margen del nivel sonoro $+3$ db
 Margen kW absorbidos $\pm 3\%$

Características en impulsión.

Rpm máximas admisibles

Clase 1	
≤ 100 °C	1250
100 ... 200 °C	1120
200 ... 300 °C	1000

Rpm

Características para:
 sistema 4 y 5 en motor
 directo con 2/4/6/8 polos
 según modelo.

Curvas Características

CAMA 1250

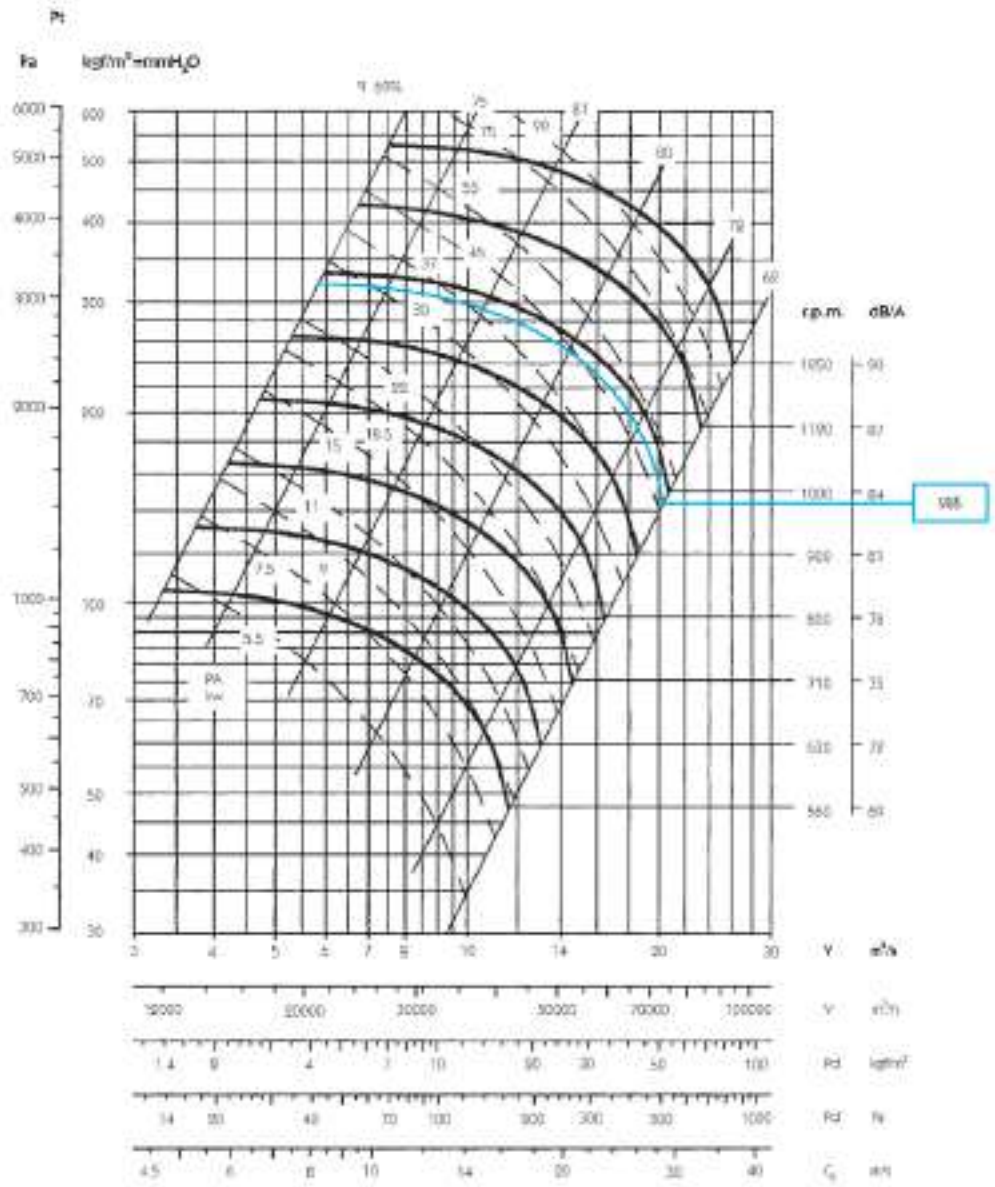

LARGE SERIES

Margen sobre el caudal $\pm 5\%$
 Margen del nivel sonoro $+3\text{ dB}$
 Margen kW absorbidos $\pm 3\%$

Características en impulsión.

Rpm máximas admisibles

Clase 1	
$\leq 100\text{ }^\circ\text{C}$	1120
100 ... 200 $^\circ\text{C}$	1000
200 ... 300 $^\circ\text{C}$	900

Rpm

Características para:
 sistema 4 y 5 en motor
 directo con 2/4/6/8 polos
 según modelo.

Curvas Características

CAMA 1400

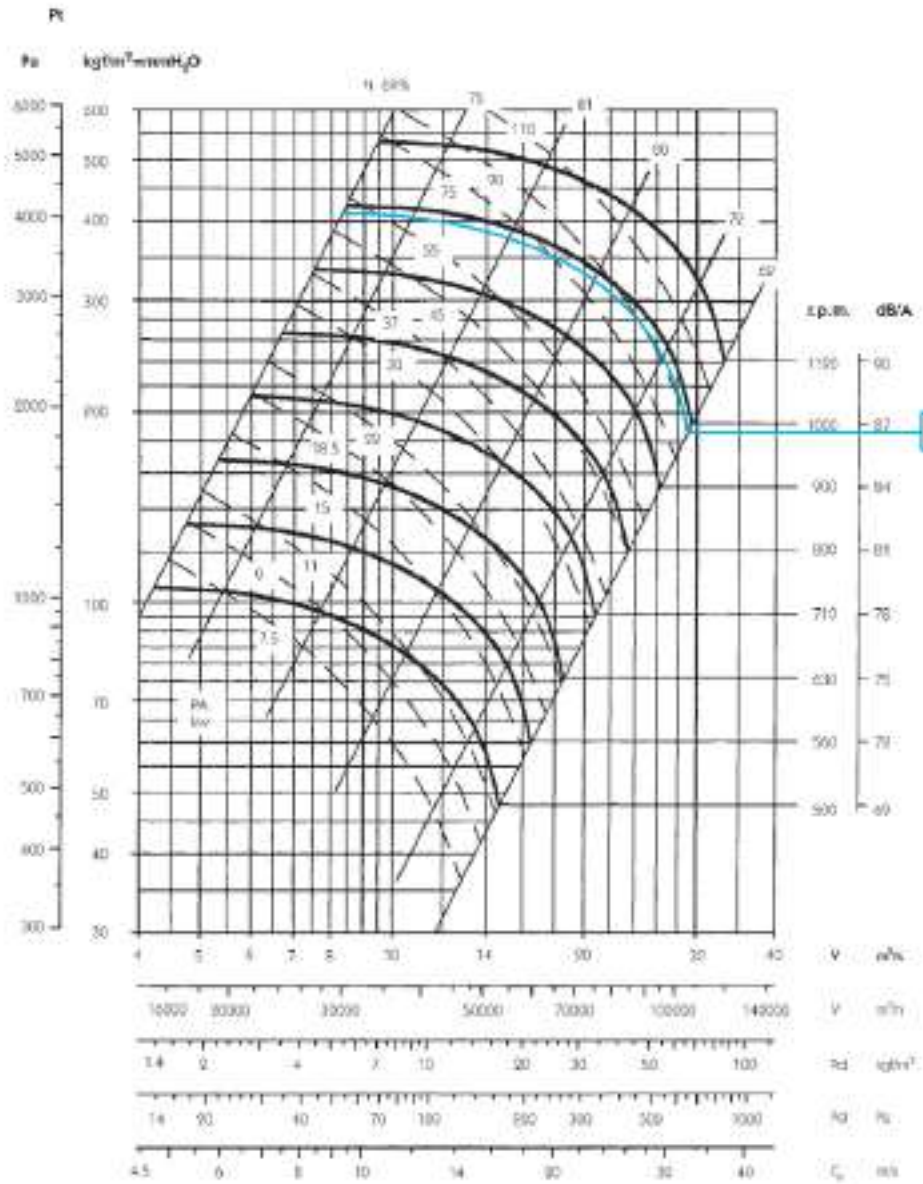

Margen sobre el caudal ± 5 %
 Margen del nivel sonoro +3 db
 Margen kW absorbidos ± 3%
 Características en impulsión.

Rpm máximas admisibles

Clase 1	
≤ 100 °C	1000
100 ... 200 °C	900
200 ... 300 °C	800

Rpm Características para:
 sistema 4 y 5 en motor
 directo con 2/4/6/8 polos
 según modelo.

LARGE SERIES

Curvas Características

CAMA 1800

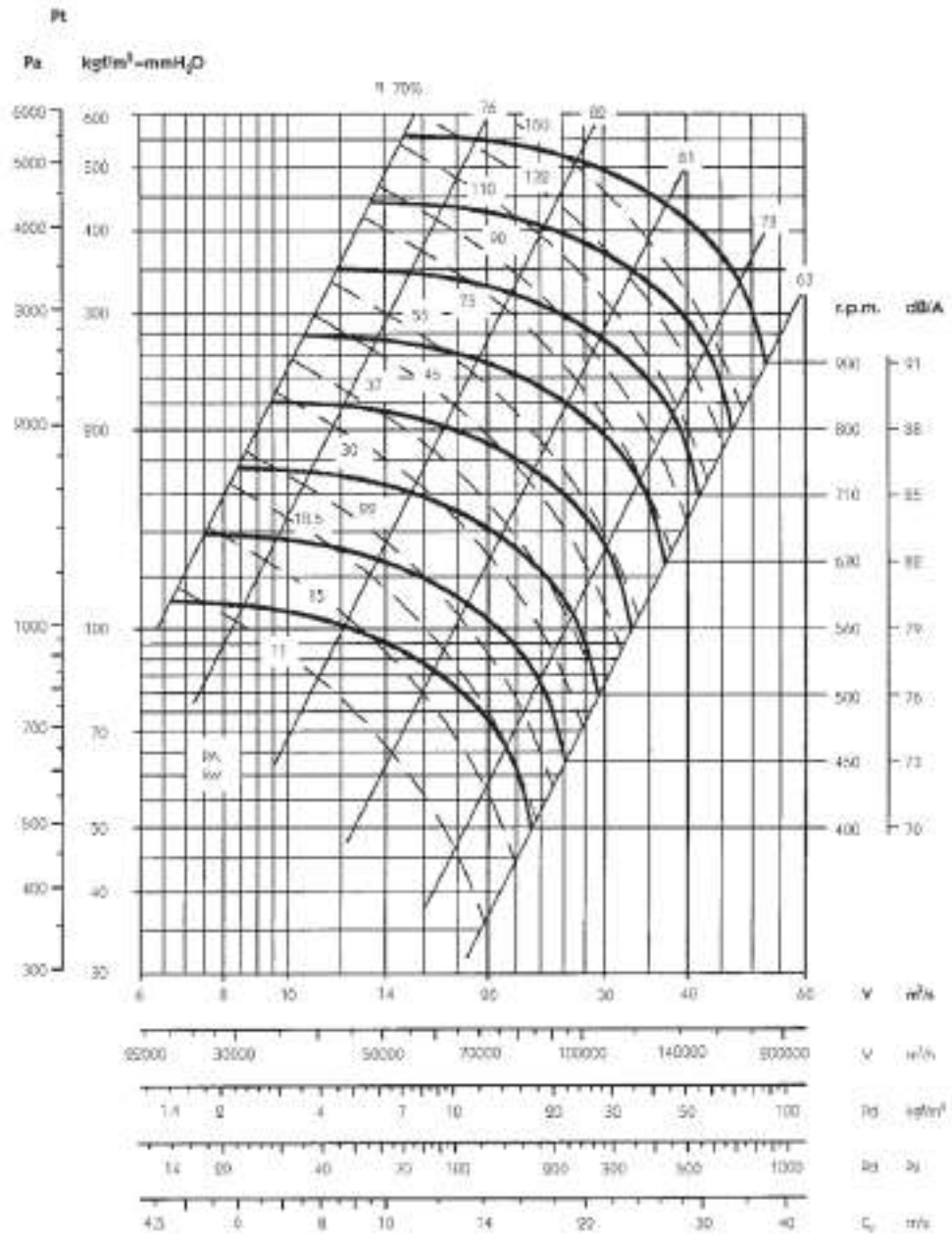

Margen sobre el caudal ± 5 %
 Margen del nivel sonoro +3 db
 Margen kW absorbidos ± 3%

Rpm máximas admisibles

Clase 1	
≤ 100 °C	800
100 ... 200 °C	710
200 ... 300 °C	630

Curvas Características

CAMA 2000

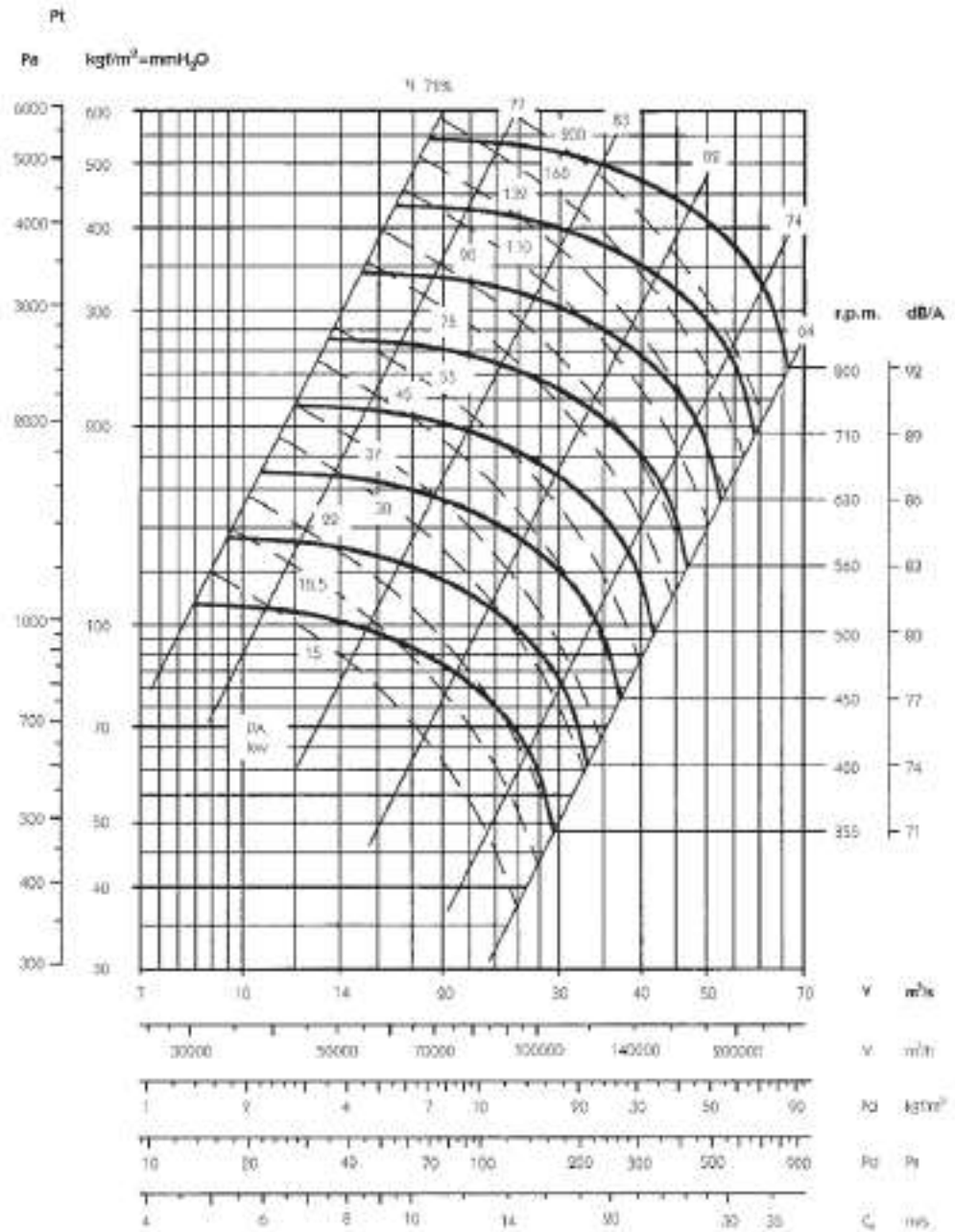

Margen sobre el caudal ± 5 %
 Margen del nivel sonoro +3 db
 Margen kW absorbidos ± 3%

Rpm máximas admisibles

Clase 1	
≤ 100 °C	710
100 ... 200 °C	630
200 ... 300 °C	560

Dimensiones mm

SISTEMA
4

CAMA 250...500

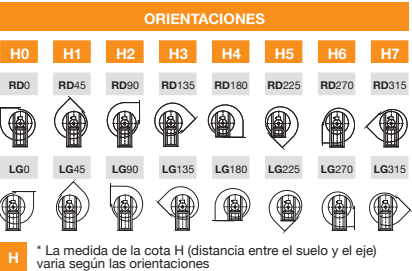
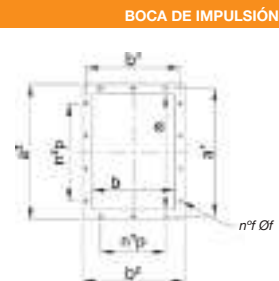
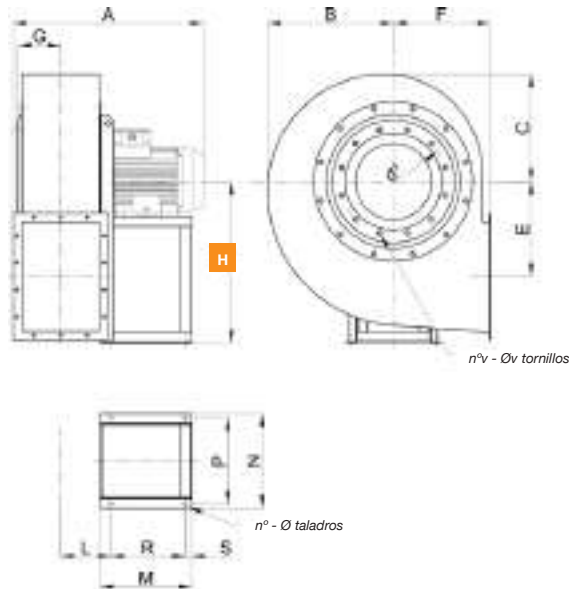

MOD.	FRAME	A*	B	C	E	F	G	HO-1-2-3	H4-5	H6-7	L	M*	N	P	R*	S
CAMA 250/B	63 B/2	390	240	210	175	195	86	315	195	315	126	150	224	200	75	25
CAMA 250/A	71 A/2	405	240	210	175	195	86	315	195	315	126	190	244	220	115	25
CAMA 280/B	71 B/2	420	265	225	202	200	95	375	200	375	135	190	244	220	115	25
CAMA 280/A	80 A/2	450	265	225	202	200	95	375	200	375	135	190	244	220	115	25
CAMA 310/B	80 B/2	465	300	255	229	225	105	400	225	400	144	190	244	220	115	25
CAMA 310/A	90 S/2	480	300	255	229	225	105	400	225	400	144	215	269	245	140	25
CAMA 350/B	90 S/2	505	335	285	253	255	116	450	255	450	155	215	269	245	140	25
CAMA 350/A	90 L/2	530	335	285	253	255	116	450	255	450	155	215	269	245	140	25
CAMA 400/B	100 LA/2	585	380	320	286	285	126	500	285	500	168	260	312	280	185	25
CAMA 400/A	112 M/2	585	380	320	286	285	126	500	285	500	168	260	312	280	185	25
CAMA 450/B	132 SA/2	700	425	360	321	320	142	560	320	560	182	320	342	310	245	25
CAMA 450/A	132 SB/2	700	425	360	321	320	142	560	320	560	182	320	342	310	245	25
CAMA 500/B	160 MA/2	805	470	405	355	360	146	600	360	600	198	425	440	400	345	30
CAMA 500/A	160 MB/2	805	470	405	355	360	146	600	360	600	198	425	440	400	345	30
CAMA 500/B	90 S/4	590	470	405	355	360	146	600	360	600	198	215	269	245	140	25
CAMA 500/A	90 L/4	615	470	405	355	360	146	600	360	600	198	215	269	245	140	25

MOD.	BOCA IMPULSIÓN														kg	WD ²	
	n°	Ø	d ¹	n°v	Øv	a	b	a ¹	b ¹	a ²	b ²	n°p	n°p	n°f			øf
CAMA 250/B	4	10	219	8	M6	205	146	241	182	275	216	1-112	1-112	8	12	20	0,1
CAMA 250/A	4	10	219	8	M6	205	146	241	182	275	216	1-112	1-112	8	12	23	0,11
CAMA 280/B	4	10	241	8	M6	229	164	265	200	299	234	1-112	1-112	8	12	30	0,15
CAMA 280/A	4	10	241	8	M6	229	164	265	200	299	234	1-112	1-112	8	12	32	0,16
CAMA 310/B	4	10	265	8	M6	256	183	292	219	326	253	1-112	2-112	10	12	40	0,2
CAMA 310/A	4	10	265	8	M6	256	183	292	219	326	253	1-112	2-112	10	12	43	0,22
CAMA 350/B	4	10	292	8	M8	288	205	332	249	368	285	1-125	2-125	10	12	65	0,45
CAMA 350/A	4	10	292	8	M8	288	205	332	249	368	285	1-125	2-125	10	12	70	0,5
CAMA 400/B	4	12	332	8	M8	322	229	366	273	402	309	1-125	2-125	10	12	100	0,7
CAMA 400/A	4	12	332	8	M8	322	229	366	273	402	309	1-125	2-125	10	12	105	0,9
CAMA 450/B	4	12	366	8	M8	361	256	405	300	441	336	1-125	2-125	10	12	140	1,1
CAMA 450/A	4	12	366	8	M8	361	256	405	300	441	336	1-125	2-125	10	12	150	1,4
CAMA 500/B	4	14	405	8	M8	404	288	448	332	484	368	2-125	3-125	14	12	225	2,5
CAMA 500/A	4	14	405	8	M8	404	288	448	332	484	368	2-125	3-125	14	12	240	2,8
CAMA 500/B	4	10	405	8	M8	404	288	448	332	484	368	2-125	3-125	14	12	125	2
CAMA 500/A	4	10	405	8	M8	404	288	448	332	484	368	2-125	3-125	14	12	130	2,2

(*) Para construcciones a "ALTA TEMP." cotas "A-M-R" + 50 mm.
(kg) Peso ventilador con motor.
WD² = Momento de inercia del rodete, expresado en Kg x m²

LARGE SERIES

Dimensiones mm

SISTEMA
4

CAMA 560...630

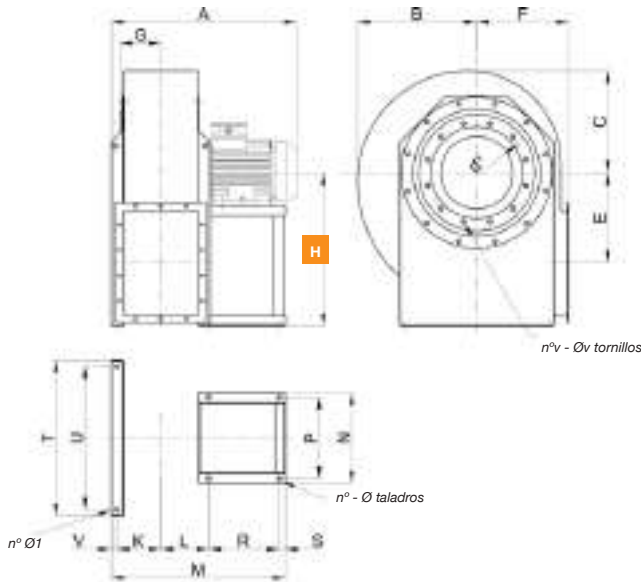

BOCA DE IMPULSIÓN

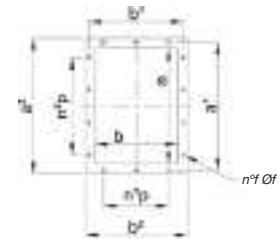

ORIENTACIONES

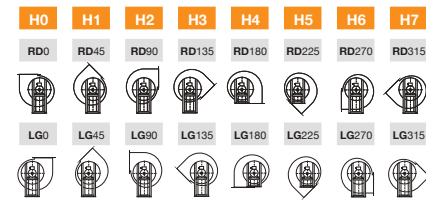

H * La medida de la cota H (distancia entre el suelo y el eje) varía según las orientaciones

MOD.	FRAME	A*	B	C	E	F	G	HO-1-2-3	H4-5	H6-7	L	K	M*
CAMA 560/B	160 L/2	950	525	445	390	400	175	670	400	670	214	196	808
CAMA 560/A	180 M/2	990	525	445	390	400	175	670	400	670	234	196	853
CAMA 560/B	100 LA/4	710	525	445	390	400	175	670	400	670	214	196	643
CAMA 560/A	100 LB/4	710	525	445	390	400	175	670	400	670	214	196	643
CAMA 630/B	112 M/4	750	590	505	441	450	199	750	450	750	234	217	684
CAMA 630/A	132 S/4	840	590	505	441	450	199	750	450	750	234	217	744

MOD.	N	P	R*	S	T	U	V	n°	Ø	Ø'	d'	n°v	Øv
CAMA 560/B	440	400	345	30	690	630	23	4	14	17	448	12	M8
CAMA 560/A	490	450	370	30	690	630	23	4	17	17	448	12	M8
CAMA 560/B	312	280	185	25	690	630	23	4	12	17	448	12	M8
CAMA 560/A	312	280	185	25	690	630	23	4	12	17	448	12	M8
CAMA 630/B	312	280	185	25	760	700	23	4	12	17	497	12	M8
CAMA 630/A	342	310	245	25	760	700	23	4	12	17	497	12	M8

BOCA IMPULSIÓN

MOD.	a	b	a'	b'	a²	b²	n°p	n²p	n°f	of	kg	WD²
CAMA 560/B	453	322	497	366	533	402	2-125	3-125	14	12	280	3,5
CAMA 560/A	453	322	497	366	533	402	2-125	3-125	14	12	310	4
CAMA 560/B	453	322	497	366	533	402	2-125	3-125	14	12	140	3,2
CAMA 560/A	453	322	497	366	533	402	2-125	3-125	14	12	140	3,5
CAMA 630/B	507	361	551	405	587	441	2-125	3-125	14	12	180	5,5
CAMA 630/A	507	361	551	405	587	441	2-125	3-125	14	12	190	6,2

(*) Para construcciones a "ALTA TEMP." cotas "A-M-R" + 50 mm.
(kg) Peso ventilador con motor.
WD² = Momento de inercia del rodete, expresado en Kg x m²

LARGE SERIES

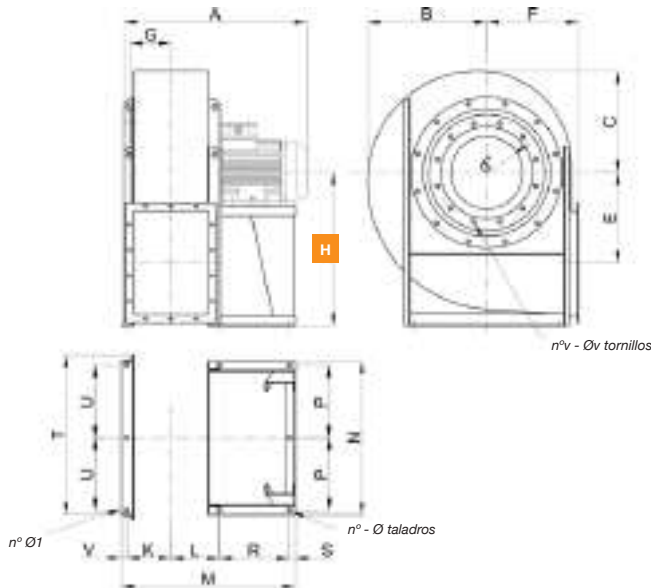
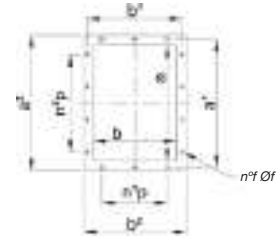
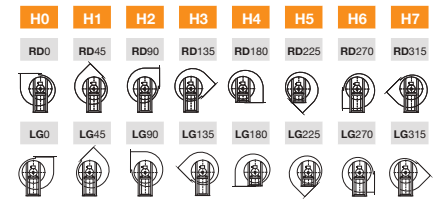
Dimensiones mm
CAMA 710...1400

BOCA DE IMPULSIÓN

ORIENTACIONES

H * La medida de la cota H (distancia entre el suelo y el eje) varía según las orientaciones

MOD.	FRAME	A*	B	C	E	F	G	HO-1-2-3	H4-5	H6-7	L	K	M*	N	P	R*	S	T
CAMA 710/B	132 MA/4	915	670	570	500	500	221	670	500	850	251	243	793	831	385	230	40	920
CAMA 710/A	160 M/4	960	670	570	500	500	221	670	500	850	251	243	898	831	385	335	40	920
CAMA 800/B	160 L/4	1090	745	635	560	560	245	750	560	950	276	267	947	921	430	335	40	1000
CAMA 800/A	180 M/4	1130	745	635	560	560	245	750	560	950	276	267	992	921	430	380	40	1000
CAMA 800/B	132 MA/6	965	745	635	560	560	245	750	560	950	276	267	842	921	430	230	40	1000
CAMA 800/A	132 MB/6	965	745	635	560	560	245	750	560	950	276	267	842	921	430	230	40	1000
CAMA 900/B	200 L/4	1240	835	710	630	630	272	850	630	1060	303	297	1116	1021	480	450	40	1100
CAMA 900/A	225 S/4	1290	835	710	630	630	272	850	630	1060	303	297	1126	1021	480	460	40	1100
CAMA 900/B	160 M/6	1060	835	710	630	630	272	850	630	1060	303	297	1001	1021	480	335	40	1100
CAMA 900/A	160 L/6	1140	835	710	630	630	272	850	630	1060	303	297	1001	1021	480	335	40	1100
CAMA 1000/B	225 M/4	1365	930	795	710	710	306	950	710	1180	334	323	1198	1120	530	450	50	1230
CAMA 1000/A	250 M/4	1440	930	795	710	710	306	950	710	1180	334	323	1268	1120	530	520	50	1230
CAMA 1000/B	180 L/6	1255	930	795	710	710	306	950	710	1180	334	323	1118	1120	530	370	50	1230
CAMA 1000/A	200 LA/6	1315	930	795	710	710	306	950	710	1180	334	323	1188	1120	530	440	50	1230
CAMA 1120/B	280 S/4	1655	1045	895	800	800	340	1060	800	1320	398	365	1477	1260	590	610	50	1370
CAMA 1120/A	280 M/4	1655	1045	895	800	800	340	1060	800	1320	398	365	1477	1260	590	610	50	1370
CAMA 1120/B	200 LB/6	1405	1045	895	800	800	340	1060	800	1320	398	365	1277	1260	590	410	50	1370
CAMA 1120/A	225 M/6	1455	1045	895	800	800	340	1060	800	1320	398	365	1287	1260	590	420	50	1370
CAMA 1250/B	250 M/6	1605	1175	1005	900	900	379	1180	900	1500	437	403	1434	1390	655	490	50	1540
CAMA 1250/A	280 S/6	1730	1175	1005	900	900	379	1180	900	1500	437	403	1554	1390	655	610	50	1540
CAMA 1400/B	280 M/6	1815	1305	1115	1000	1000	428	1320	1000	1700	500	446	1640	1530	725	580	60	1690
CAMA 1400/A	315 S/6	1835	1305	1115	1000	1000	428	1320	1000	1700	500	446	1700	1530	725	640	60	1690

BOCA IMPULSIÓN

MOD.	U	V	n°	Ø	Ø¹	d¹	n°v	Øv	a	b	a¹	b¹	a²	b²	n¹p	n²p	n¹f	Øf	kg	WD²
CAMA 710/B	385	29	5+3	19	19	551	12	M8	569	404	629	464	669	504	2-160	3-160	14	14	270	10,5
CAMA 710/A	385	29	5+3	19	19	551	12	M8	569	404	629	464	669	504	2-160	3-160	14	14	300	12
CAMA 800/B	430	29	5+3	19	19	629	12	M8	638	453	698	513	738	553	2-160	3-160	14	14	400	16,5
CAMA 800/A	430	29	5+3	19	19	629	12	M8	638	453	698	513	738	553	2-160	3-160	14	14	425	18,5
CAMA 800/B	430	29	5+3	19	19	629	12	M8	638	453	698	513	738	553	2-160	3-160	14	14	330	15
CAMA 800/A	430	29	5+3	19	19	629	12	M8	638	453	698	513	738	553	2-160	3-160	14	14	340	17,5
CAMA 900/B	480	26	5+3	19	19	698	12	M10	715	507	775	567	815	607	2-160	4-160	16	14	570	30
CAMA 900/A	480	26	5+3	19	19	698	12	M10	715	507	775	567	815	607	2-160	4-160	16	14	610	35
CAMA 900/B	480	26	5+3	19	19	698	12	M10	715	507	775	567	815	607	2-160	4-160	16	14	460	29
CAMA 900/A	480	26	5+3	19	19	698	12	M10	715	507	775	567	815	607	2-160	4-160	16	14	490	34
CAMA 1000/B	530	41	5+3	19	19	775	16	M10	801	569	871	639	921	689	2-200	3-200	14	14	755	48
CAMA 1000/A	530	41	5+3	19	19	775	16	M10	801	569	871	639	921	689	2-200	3-200	14	14	825	52
CAMA 1000/B	530	41	5+3	19	19	775	16	M10	801	569	871	639	921	689	2-200	3-200	14	14	650	47
CAMA 1000/A	530	41	5+3	19	19	775	16	M10	801	569	871	639	921	689	2-200	3-200	14	14	680	50
CAMA 1120/B	590	54	5+3	24	24	861	16	M10	898	638	968	708	1018	758	3-200	4-200	18	14	1200	105
CAMA 1120/A	590	54	5+3	24	24	861	16	M10	898	638	968	708	1018	758	3-200	4-200	18	14	1250	120
CAMA 1120/B	590	54	5+3	24	24	861	16	M10	898	638	968	708	1018	758	3-200	4-200	18	14	980	115
CAMA 1120/A	590	54	5+3	24	24	861	16	M10	898	638	968	708	1018	758	3-200	4-200	18	14	1040	116
CAMA 1250/B	655	54	5+3	24	24	958	16	M10	1007	715	1077	785	1127	835	3-200	4-200	18	14	1300	180
CAMA 1250/A	655	54	5+3	24	24	958	16	M10	1007	715	1077	785	1127	835	3-200	4-200	18	14	1400	190
CAMA 1400/B	725	54	5+3	24	24	1067	24	M10	1130	801	1210	881	1270	941	3-200	5-200	20	18	1850	300
CAMA 1400/A	725	54	5+3	24	24	1067	24	M10	1130	801	1210	881	1270	941	3-200	5-200	20	18	1950	320

(*) Para construcciones a "ALTA TEMP." cotas "A-M-R" + 50 mm.
(kg) Peso ventilador con motor.
WD² = Momento de inercia del rodete, expresado en Kg x m²

Dimensiones mm

CAMA-X 250...500

SISTEMA
1

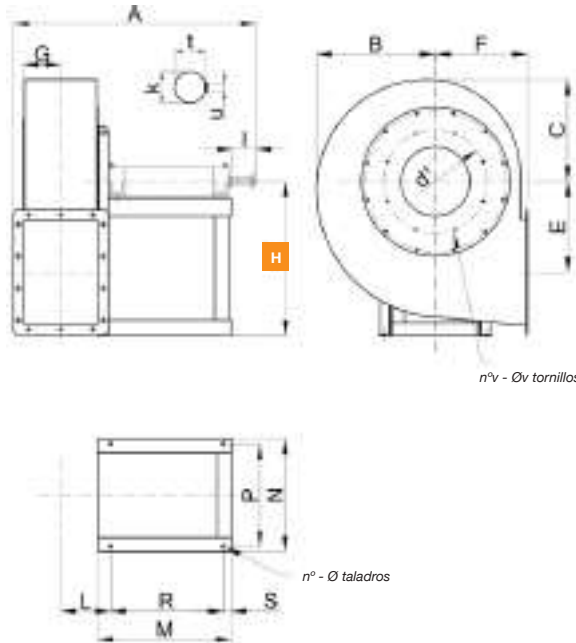

n° - Øv tornillos

n° - Ø taladros

SISTEMA
12

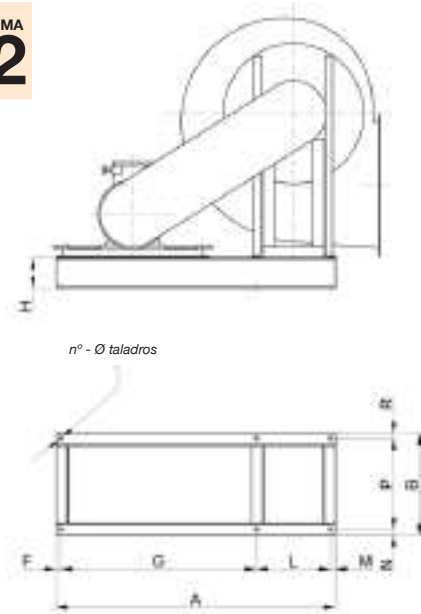

n° - Ø taladros

MOD.	A*	B	C	E	F	G	H0	H1	H2	H3	H4	H5
CAMA 250	465	240	210	175	195	86	315	315	315	315	195	195
CAMA 280	560	265	225	202	200	95	375	375	375	375	200	200
CAMA 310	580	300	255	229	225	105	400	400	400	400	225	225
CAMA 350	805	335	285	253	255	116	450	450	450	450	255	255
CAMA 400	930	380	320	286	285	126	500	500	500	500	285	285
CAMA 450	960	425	360	321	320	142	560	560	560	560	320	320
CAMA 500	1000	470	405	355	360	158	600	600	600	600	360	360

MOD.	A	B*	H	F	G	L	M	N	P*	R	N°	Φ	kg
CAMA 250	700	185	80	15	480	190	15	20	145	20	6	10	19
CAMA 280	895	265	100	20	630	230	15	25	215	25	6	12	30
CAMA 310	895	265	100	20	630	230	15	25	215	25	6	12	30
CAMA 350	980	450	120	20	630	310	20	25	400	25	6	14	45
CAMA 400	1020	530	120	20	650	330	20	25	480	25	6	14	50
CAMA 450	1175	530	120	25	800	330	20	25	480	25	6	14	55
CAMA 500	1265	495	160	25	830	385	25	30	430	35	6	17	78

MOD.	H6	H7	L	M*	N	P	R*	S	n°	Φ	k	l
CAMA 250	315	315	126	220	214	190	145	25	4	10	19k6	40
CAMA 280	375	375	135	290	254	230	215	25	4	12	24k6	50
CAMA 310	400	400	144	290	254	230	215	25	4	12	24k6	50
CAMA 350	450	450	155	480	350	310	400	30	4	14	28k6	60
CAMA 400	500	500	168	560	370	330	480	30	4	14	38k6	80
CAMA 450	560	560	182	560	370	330	480	30	4	14	38k6	80
CAMA 500	600	600	198	520	438	385	430	40	4	17	42k6	110

(*) Para construcciones a "ALTA TEMP." en mod. de 250 a 500, cotas "B-P" + 50 mm.
Kg = Peso de la base soporte

MOD.	t	u	d ¹	n°v	Φv	kg	WD ²
CAMA 250	21,5	6	219	8	M6	27	0,11
CAMA 280	27	8	241	8	M6	27	0,16
CAMA 310	27	8	265	8	M6	43	0,22
CAMA 350	31	8	292	8	M8	73	0,5
CAMA 400	41	10	332	8	M8	85	0,9
CAMA 450	41	10	366	8	M8	105	1,4
CAMA 500	45	12	405	8	M8	145	2,8

(*) Para construcciones a "ALTA TEMP." en mod. de 250 a 500, cotas "A-M-R" + 50 mm.
(kg) Peso ventilador sin motor.
WD² = Momento de inercia del rodete, expresado en Kg x m²

BOCA DE IMPULSIÓN

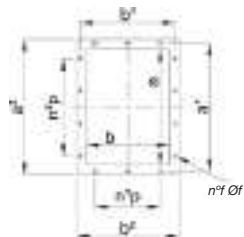

n° Of

BOCA IMPULSIÓN

MOD.	a	b	a ¹	b ¹	a ²	b ²	n°p	n°f	Φf	
CAMA 250	205	146	241	182	275	216	1-112	1-112	8	12
CAMA 280	229	164	265	200	299	234	1-112	1-112	8	12
CAMA 310	256	183	292	219	326	253	1-112	2-112	10	12
CAMA 350	288	205	332	249	368	285	1-125	2-125	10	12
CAMA 400	322	229	366	273	402	309	1-125	2-125	10	12
CAMA 450	361	256	405	300	441	336	1-125	2-125	10	12
CAMA 500	404	288	448	332	484	368	2-125	3-125	14	12

ORIENTACIONES

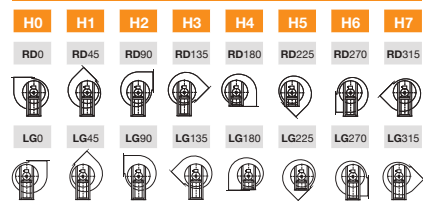

H * La medida de la cota H (distancia entre el suelo y el eje) varía según las orientaciones

LARGE SERIES

Dimensiones mm

CAMA-X 560...630

SISTEMA
1

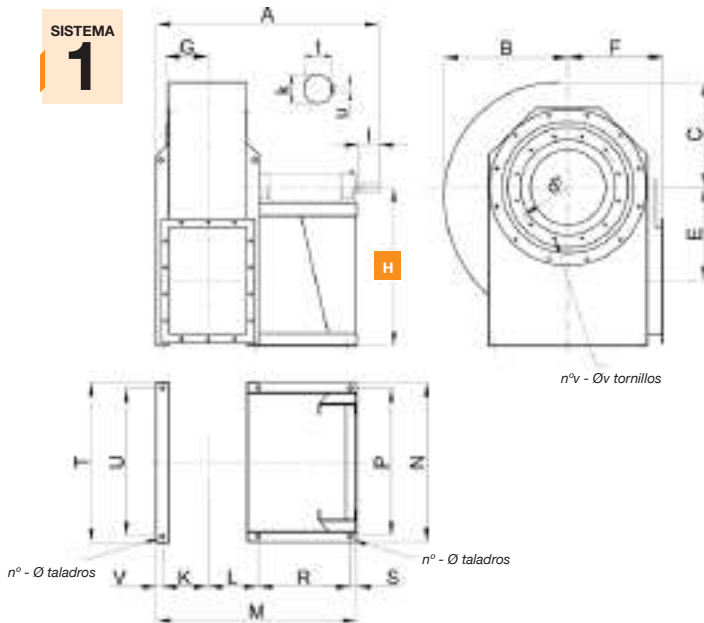

SISTEMA
12

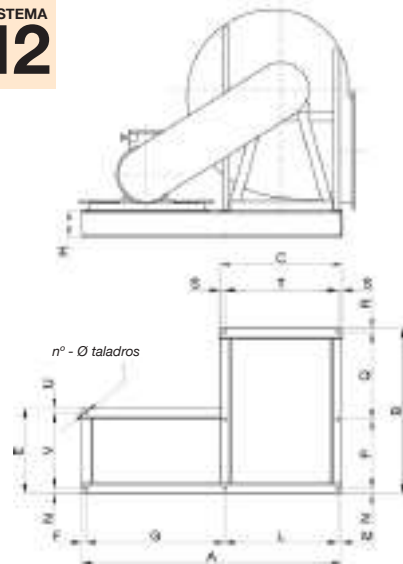

MOD.	A*	B	C	E	F	G	H0	H1	H2	H3
CAMA 560	1055	525	445	390	400	175	670	670	670	670
CAMA 630	1095	590	505	441	450	199	750	750	750	750

MOD.	A	B*	C	E	H	F	G	L	M	N
CAMA 560	1415	893	690	510	160	25	735	630	25	30
CAMA 630	1610	933	760	530	160	25	860	700	25	30

MOD.	H4	H5	H6	H7	L	K	M*	N	P	R*
CAMA 560	400	400	670	670	214	196	903	683	630	430
CAMA 630	450	450	750	750	233	217	943	753	700	430

MOD.	P*	Q	R	S	T	U	V	N°	Φ	kg
CAMA 560	430	410	23	30	630	25	455	8	17	105
CAMA 630	430	450	23	30	700	25	475	8	17	115

MOD.	S	T	U	V	n°	Φ	k	l	t	u
CAMA 560	40	690	630	23	4+2	17	48k6	110	51,5	14
CAMA 630	40	760	700	23	4+2	17	48k6	110	51,5	14

MOD.	d ¹	n°v	Φv	kg	WD ²
CAMA 560	448	12	M8	175	4
CAMA 630	497	12	M8	210	6,6

(*) Para construcciones a "ALTA TEMP." en mod. de 560 a 630, cotas "A-M-R" + 50 mm.
(kg) Peso ventilador sin motor.
WD² = Momento de inercia del rodete, expresado en Kg x m²

(*) Para construcciones a "ALTA TEMP." en mod. de 560 a 630, cotas "B-P" + 50 mm.
Kg = Peso de la base soporte

BOCA DE IMPULSIÓN

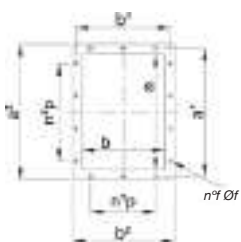

BOCA IMPULSIÓN

MOD.	a	b	a'	b'	a''	b''	n°p	n°p'	n°f	Φf
CAMA 560	453	322	497	366	533	402	2-125	3-125	14	12
CAMA 630	507	361	551	405	587	441	2-125	3-125	14	12

ORIENTACIONES

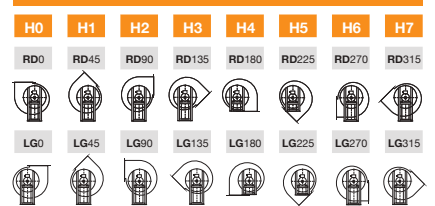

H * La medida de la cota H (distancia entre el suelo y el eje) varía según las orientaciones

Dimensiones mm

CAMA-X 710...2000

SISTEMA 1

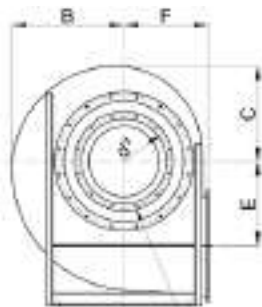
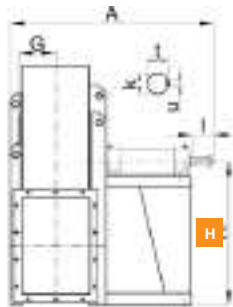

n°v - Øv tornillos

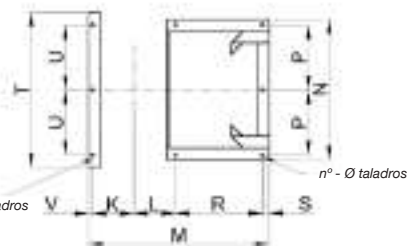

n° - Ø taladros

SISTEMA 12

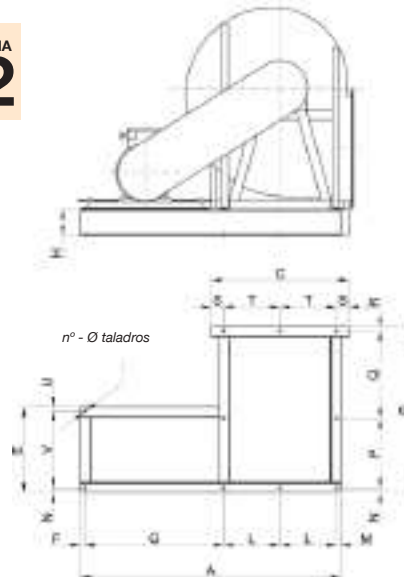

n° - Ø taladros

MOD.	A*	B	C	E	F	G	H0	H1	H2	H3	H4	H5
CAMA 710	1235	670	570	500	500	221	670	670	670	670	500	500
CAMA 800	1335	745	635	560	560	245	750	750	750	750	560	560
CAMA 900	1390	835	710	630	630	272	850	850	850	850	630	630
CAMA 1000	1545	930	795	710	710	306	950	950	950	950	710	710
CAMA 1120	1820	1045	895	800	800	341	1060	1060	1060	1060	800	800
CAMA 1250	1895	1175	1005	900	900	379	1180	1180	1180	1180	900	900
CAMA 1400	2060	1305	1115	1000	1000	428	1320	1320	1320	1320	1000	1000
CAMA 1600	2350	1535	1245	1120	1120	479	1500	1500	1250	1250	1120	1120
CAMA 1800	2530	1705	1390	1250	1250	535	1650	1550	1400	1320	1250	1250
CAMA 2000	2650	1920	1555	1400	1400	577	1850	1700	1600	1450	1400	1400

MOD.	A	B*	C	E	H	F	G	L	M	N	P*
CAMA 710	1980	1069	920	690	180	30	1150	385	30	30	515
CAMA 800	2070	1166	1000	690	180	30	1150	430	30	30	565
CAMA 900	2200	1124	1100	750	180	30	1180	480	30	30	565
CAMA 1000	2300	1329	1230	755	180	30	1180	530	30	35	605
CAMA 1120	2470	1592	1370	830	180	35	1220	590	35	35	760
CAMA 1250	2600	1667	1540	830	180	35	1220	655	35	35	760
CAMA 1400	3150	1794	1690	990	180	35	1630	725	35	35	780
CAMA 1600	3340	2063	1950	990	180	35	1630	820	35	35	920
CAMA 1800	3600	2185	2150	1100	180	35	1700	915	35	35	920
CAMA 2000	3800	2309	2390	1100	180	35	1700	1015	35	35	920

MOD.	H6	H7	L	K	M*	N	P	R*	S	T	U	V
CAMA 710	850	850	251	243	1078	831	385	515	40	920	385	29
CAMA 800	950	950	276	267	1177	921	430	565	40	1000	430	29
CAMA 900	1060	1060	303	297	1231	1021	480	565	40	1100	480	26
CAMA 1000	1180	1180	334	323	1353	1120	530	605	50	1230	530	41
CAMA 1120	1320	1320	398	365	1627	1260	590	760	50	1370	590	54
CAMA 1250	1500	1500	437	403	1704	1390	655	760	50	1540	655	54
CAMA 1400	1700	1500	500	446	1840	1530	725	780	60	1690	725	54
CAMA 1600	1900	1600	568	505	2117	1720	820	920	60	1950	820	64
CAMA 1800	2120	1800	623	569	2226	1910	915	920	60	2150	915	54
CAMA 2000	2360	2000	684	631	2379	2110	1015	920	60	2390	1015	84

MOD.	Q	R	S	T	U	V	N°	Φ	kg
CAMA 710	494	30	75	385	30	630	10	19	167
CAMA 800	543	28	70	430	30	630	10	19	175
CAMA 900	600	29	70	480	30	690	10	19	190
CAMA 1000	657	32	85	530	30	690	10	19	200
CAMA 1120	763	34	95	590	35	760	10	24	295
CAMA 1250	840	32	115	655	35	760	10	24	310
CAMA 1400	946	33	120	725	35	920	10	24	365
CAMA 1600	1073	35	155	820	35	920	10	28	390
CAMA 1800	1192	38	160	915	35	1030	10	28	475
CAMA 2000	1315	39	180	1015	35	1030	10	28	500

(*) Para construcciones a "ALTA TEMP." en mod. de 710 a 900, cotas "B-P" + 50 mm.
Kg = Peso de la base soporte

MOD.	n°	Φ	k	l	t	u	d ¹	n°v	Φv	kg	WD ²
CAMA 710	5+3	19	48k6	110	51,5	14	551	12	M8	290	12,3
CAMA 800	5+3	19	55m6	110	59	16	629	12	M8	260	19
CAMA 900	5+3	19	55m6	110	59	16	698	12	M10	410	35,5
CAMA 1000	5+3	19	65 m6	140	69	18	775	16	M10	530	52
CAMA 1120	5+3	24	75m6	140	79,5	20	861	16	M10	870	120
CAMA 1250	5+3	24	75m6	140	79,5	20	958	16	M10	1070	190
CAMA 1400	5+3	24	80m6	170	85	22	1067	24	M10	1520	320
CAMA 1600	5+3	28	90m6	170	95	25	1200	24	M10	2000	520
CAMA 1800	5+3	28	100j6	210	106	28	1337	24	M10	1850	900
CAMA 2000	5+3	28	100j6	210	106	28	1491	32	M10	3550	1400

(*) Para construcciones a "ALTA TEMP." en mod. de 710 a 900, cotas "A-M-R" + 50 mm.
(kg) Peso ventilador sin motor.
WD² = Momento de inercia del rodete, expresado en Kg x m²

BOCA DE IMPULSIÓN

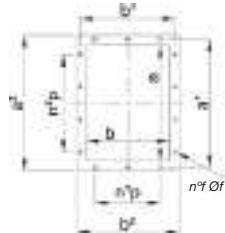

n°f Of

BOCA IMPULSIÓN

MOD.	a	b	a'	b'	a''	b''	n°p	n°p	n°f	Φf
CAMA 710	569	404	629	464	669	504	2-160	3-160	14	14
CAMA 800	638	453	698	513	738	553	2-160	3-160	14	14
CAMA 900	715	507	775	567	815	607	2-160	4-160	16	14
CAMA 1000	801	569	871	639	921	689	2-200	3-200	14	14
CAMA 1120	898	638	968	708	1018	758	3-200	4-200	18	14
CAMA 1250	1007	715	1077	785	1127	835	3-200	4-200	18	14
CAMA 1400	1130	801	1210	881	1270	941	3-200	5-200	20	18
CAMA 1600	1267	898	1347	978	1407	1038	4-200	6200	24	18
CAMA 1800	1421	1007	1501	1087	1561	1147	4-200	6-200	24	18
CAMA 2000	1593	1130	1683	1220	1753	1290	5-200	7-200	28	22

ORIENTACIONES

H0	H1	H2	H3	H4	H5	H6	H7
RD0	RD45	RD90	RD135	RD180	RD225	RD270	RD315
LG0	LG45	LG90	LG135	LG180	LG225	LG270	LG315

H * La medida de la cota H (distancia entre el suelo y el eje) varía según las orientaciones

LARGE SERIES

Accesorios

Contrabrida aspiración

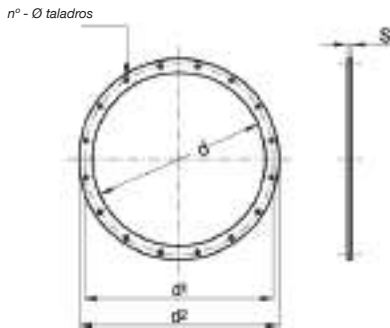

MOD.	d	d'	d ²	n°	Φ	S	kg
CAMA 250	185	219	255	8	9	4	0,7
CAMA 280	205	241	275	8	9	4	0,75
CAMA 310	229	265	299	8	9	4	0,8
CAMA 350	255	292	325	8	11	4	1
CAMA 400	286	332	366	8	11	5	1,6
CAMA 450	321	366	401	8	11	5	1,8
CAMA 500	361	405	441	8	11	5	2
CAMA 560	406	448	486	12	11	5	2,2
CAMA 630	456	497	536	12	11	5	2,5
CAMA 710	506	551	586	12	11	5	2,7
CAMA 800	568	629	668	12	11	6	4,6
CAMA 900	638	698	738	12	11	6	5
CAMA 1000	718	775	818	16	13	6	5,5
CAMA 1120	808	861	908	16	13	6	6,2
CAMA 1250	908	958	1008	16	13	6	7
CAMA 1400	1008	1067	1108	24	13	6	7,8
CAMA 1600	1130	1200	1250	24	13	8	14
CAMA 1800	1260	1337	1380	24	13	8	15,5
CAMA 2000	1410	1491	1530	32	13	8	17

Contrabrida impulsión

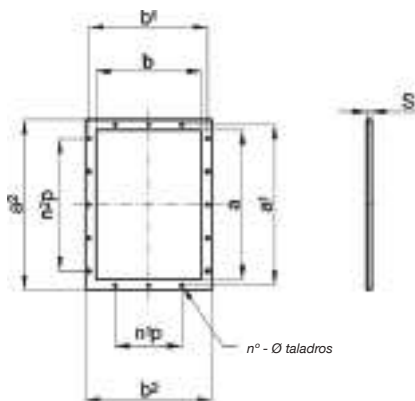

MOD.	a	b	a'	b'	a ²	b ²	n°p	n²p	n°	Φ	s	kg
CAMA 250	205	146	241	182	275	216	1-112	1-112	8	12	4	0,9
CAMA 280	229	164	265	200	299	234	1-112	1-112	8	12	4	1
CAMA 310	256	183	292	219	326	253	1-112	2-112	10	12	4	1,1
CAMA 350	288	205	332	249	368	285	1-125	2-125	10	12	5	1,8
CAMA 400	322	229	366	273	402	309	1-125	2-125	10	12	5	2
CAMA 450	361	256	405	300	441	336	1-125	2-125	10	12	5	2,2
CAMA 500	404	288	448	332	484	368	2-125	3-125	14	12	5	2,4
CAMA 560	453	322	497	366	533	402	2-125	3-125	14	12	5	2,7
CAMA 630	507	361	551	405	587	441	2-125	3-125	14	12	5	3
CAMA 710	569	404	629	464	669	504	2-160	3-160	14	14	6	5
CAMA 800	638	453	698	513	738	553	2-160	3-160	14	14	6	5,6
CAMA 900	715	507	775	567	815	607	2-160	4-160	16	14	6	6,2
CAMA 1000	801	569	871	639	921	689	2-200	3-200	14	14	8	11,2
CAMA 1120	898	638	968	708	1018	758	3-200	4-200	18	14	8	12,5
CAMA 1250	1007	715	1077	785	1127	835	3-200	4-200	18	14	8	14
CAMA 1400	1130	801	1210	881	1270	941	3-200	5-200	20	18	8	18
CAMA 1600	1267	898	1347	978	1407	1038	4-200	6-200	24	18	8	20
CAMA 1800	1421	1007	1501	1087	1561	1147	4-200	6-200	24	18	8	22,3
CAMA 2000	1593	1130	1683	1220	1753	1290	5-200	7-200	28	22	8	28,5

Red protección en aspiración

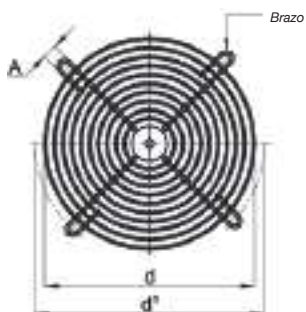

MOD.	d	d'	A	n°	kg
CAMA 250	185	222	9	4	0,18
CAMA 280	205	332	9	4	0,2
CAMA 310	229	366	9	4	0,25
CAMA 350	255	405	11	4	0,3
CAMA 400	286	448	11	4	0,35
CAMA 450	321	497	11	4	0,4
CAMA 500	361	551	11	8	0,7
CAMA 560	406	629	11	8	0,8
CAMA 630	456	698	11	8	0,9
CAMA 710	506	775	11	8	1
CAMA 800	568	861	11	8	1,2
CAMA 900	638	958	11	8	1,5
CAMA 1000	718	1067	13	8	2
CAMA 1120	808	1200	13	8	2,5
CAMA 1250	908	1337	13	8	3
CAMA 1400	1008	1491	13	8	3,5
CAMA 1600	1130	1663	13	8	4
CAMA 1800	1260	1856	13	8	4,5
CAMA 2000	1410	2073	13	8	5

Accesorios

Junta anti vibratoria en aspiración

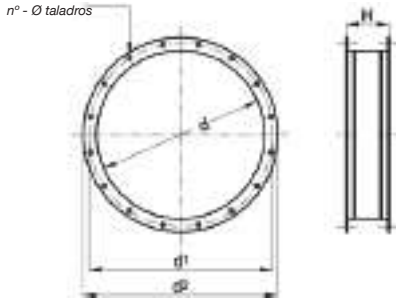

MOD.	d	d'	d ²	n°	Φ	H	kg
CAMA 250	185	219	255	8	9	200	1,7
CAMA 280	205	241	275	8	9	200	1,8
CAMA 310	229	265	299	8	9	200	2
CAMA 350	255	292	325	8	11	200	2,2
CAMA 400	286	332	366	8	11	200	3,4
CAMA 450	321	366	401	8	11	200	3,8
CAMA 500	361	405	441	8	11	200	4,2
CAMA 560	406	448	486	12	11	200	4,6
CAMA 630	456	497	536	12	11	200	5,1
CAMA 710	506	551	586	12	11	200	5,6
CAMA 800	568	629	668	12	11	200	9,4
CAMA 900	638	698	738	12	11	200	10,4
CAMA 1000	718	775	818	16	13	200	11,6
CAMA 1120	808	861	908	16	13	200	13
CAMA 1250	908	958	1008	16	13	200	14,4
CAMA 1400	1008	1067	1108	24	13	200	16
CAMA 1600	1130	1200	1250	24	13	200	28,5
CAMA 1800	1260	1337	1380	24	13	200	31,5
CAMA 2000	1410	1491	1530	32	13	200	34,5

Junta anti vibratoria en impulsión

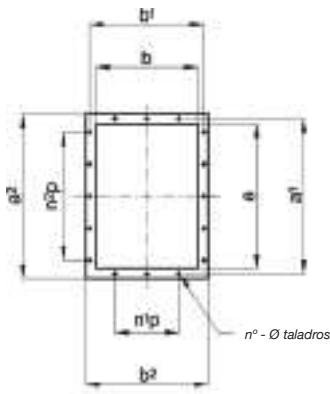

MOD.	a	b	a'	b'	a ²	b ²	n°p	n°p	n°	Φ	H	kg
CAMA 250	205	146	241	182	275	216	1-112	1-112	8	12	200	2
CAMA 280	229	164	265	200	299	234	1-112	1-112	8	12	200	2,2
CAMA 310	256	183	292	219	326	253	1-112	2-112	10	12	200	2,4
CAMA 350	288	205	332	249	368	285	1-125	2-125	10	12	200	3,8
CAMA 400	322	229	366	273	402	309	1-125	2-125	10	12	200	4,2
CAMA 450	361	256	405	300	441	336	1-125	2-125	10	12	200	4,6
CAMA 500	404	288	448	332	484	368	2-125	3-125	14	12	200	5
CAMA 560	453	322	497	366	533	402	2-125	3-125	14	12	200	5,6
CAMA 630	507	361	551	405	587	441	2-125	3-125	14	12	200	6,2
CAMA 710	569	404	629	464	669	504	2-160	3-160	14	14	200	10,2
CAMA 800	638	453	698	513	738	553	2-160	3-160	14	14	200	11,4
CAMA 900	715	507	775	567	815	607	2-160	4-160	16	14	200	12,6
CAMA 1000	801	569	871	639	921	689	2-200	3-200	14	14	200	23
CAMA 1120	898	638	968	708	1018	758	3-200	4-200	18	14	200	25,5
CAMA 1250	1007	715	1077	785	1127	835	3-200	4-200	18	14	200	28,5
CAMA 1400	1130	801	1210	881	1270	941	3-200	5-200	20	18	200	37
CAMA 1600	1267	898	1347	978	1407	1038	4-200	6-200	24	18	200	41
CAMA 1800	1421	1007	1501	1087	1561	1147	4-200	6-200	24	18	200	45,5
CAMA 2000	1593	1130	1683	1220	1753	1290	5-200	7-200	28	22	200	58

Regulador de caudal en aspiración

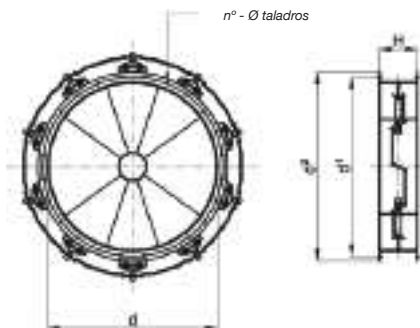

MOD.	d	d'	d ²	n°	Φ	H	kg
CAMA 450	321	366	401	8	11	200	24
CAMA 500	361	405	441	8	11	250	26
CAMA 560	406	448	486	12	11	250	30
CAMA 630	456	497	536	12	11	250	32
CAMA 710	506	551	586	12	11	250	45
CAMA 800	568	629	668	12	11	250	50
CAMA 900	638	698	738	12	11	300	58
CAMA 1000	718	775	818	16	13	300	68
CAMA 1120	808	861	908	16	13	350	87
CAMA 1250	908	958	1008	16	13	350	102
CAMA 1400	1008	1067	1108	24	13	350	120
CAMA 1600	1130	1200	1250	24	13	400	150
CAMA 1800	1260	1337	1380	24	13	400	170
CAMA 2000	1410	1491	1530	32	13	400	190

LARGE SERIES

Accesorios

Dámper de aletas contrapuestas

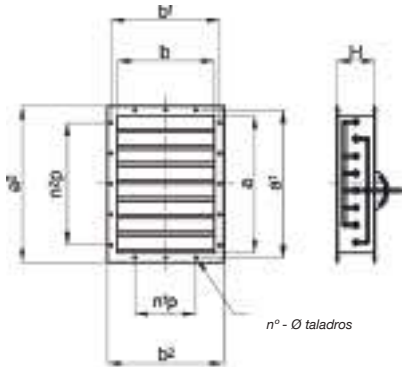

MOD.	a	b	a1	b1	a2	b2	n1p	n2p	n°	Φ	H (1)	H (2)	kg (1)	kg (2)
CAMA 400	322	229	366	273	402	309	1-125	2-125	10	12	220	250	11	12
CAMA 450	361	256	405	300	441	336	1-125	2-125	10	12	220	250	14	15
CAMA 500	404	288	448	332	484	368	2-125	3-125	14	12	220	250	18	19
CAMA 560	453	322	497	366	533	402	2-125	3-125	14	12	220	250	21	22
CAMA 630	507	361	551	405	587	441	2-125	3-125	14	12	220	250	24	25
CAMA 710	569	404	629	464	669	504	2-160	3-160	14	14	220	250	28	29
CAMA 800	638	453	698	513	738	553	2-160	3-160	14	14	220	250	32	33
CAMA 900	715	507	775	567	815	607	2-160	4-160	16	14	220	250	36	38
CAMA 1000	801	569	871	639	921	689	2-200	3-200	14	14	220	250	44	46
CAMA 1120	898	638	968	708	1018	758	3-200	4-200	18	14	220	250	50	52
CAMA 1250	1007	715	1077	785	1127	835	3-200	4-200	18	14	220	250	55	58
CAMA 1400	1130	801	1210	881	1270	941	3-200	5-200	20	18	220	250	81	84
CAMA 1600	1267	898	1347	978	1407	1038	4-200	6-200	24	18	220	250	92	96
CAMA 1800	1421	1007	1501	1087	1561	1147	4-200	6-200	24	18	220	250	105	110
CAMA 2000	1593	1130	1683	1220	1753	1290	5-200	7-200	28	22	220	250	140	145

(1) Hasta 300 mm H₂O.
(2) A partir de 300 mm H₂O.

Amortiguadores

TIPO 1

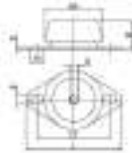

TIPO 2

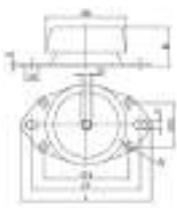

TIPO 3

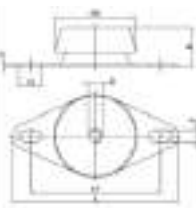

MOD.	MODELO AMORTIGUADORES	TIPO	øA	B	D	CF	CF1	CF2	F	øF1	L	M	S
CAMA-250	CF 623110	1	67	33...34	10	76,5	-	-	9	-	90,5	16	2
CAMA-280	CF 623110	1	67	33...34	10	76,5	-	-	9	-	90,5	16	2
CAMA-310	CF 623110	1	67	33...34	10	76,5	-	-	9	-	90,5	16	2
CAMA-350	CF 623110	1	67	33...34	10	76,5	-	-	9	-	90,5	16	2
CAMA-400	CF 623110	1	67	33...34	10	76,5	-	-	9	-	90,5	16	2
CAMA-450	CF 623110	1	67	33...34	10	76,5	-	-	9	-	90,5	16	2
CAMA-500	CF 623110	1	67	33...34	10	76,5	-	-	9	-	90,5	16	2
CAMA-560	CF 623110	1	67	33...34	10	76,5	-	-	9	-	90,5	16	2
CAMA-630	CF 623110	1	67	33...34	10	76,5	-	-	9	-	90,5	16	2
CAMA-710	CF 623110	1	67	33...34	10	76,5	-	-	9	-	90,5	16	2
CAMA-800	CF 924512	2	92	44...45	12	120	98	50	10,5	8,5	130	15,5	2,5
CAMA-900	CF 924512	2	92	44...45	12	120	98	50	10,5	8,5	130	15,5	2,5
CAMA-1000	CF 924512	2	92	44...45	12	120	98	50	10,5	8,5	130	15,5	2,5
CAMA-1120	CF 924512	2	92	44...45	12	120	98	50	10,5	8,5	130	15,5	2,5
CAMA-1250	CF 924512	2	92	44...45	12	120	98	50	10,5	8,5	130	15,5	2,5
CAMA-1400	CF 924512	2	92	44...45	12	120	98	50	10,5	8,5	130	15,5	2,5
CAMA-1600	CF 1204516	3	92	45	26,5	149,5			14		190	16	3,5
CAMA-1800	CF 1204516	3	92	45	26,5	149,5			14		190	16	3,5
CAMA-2000	CF 1204516	3	92	45	26,5	149,5			14		190	16	3,5

Silenciadores circulares

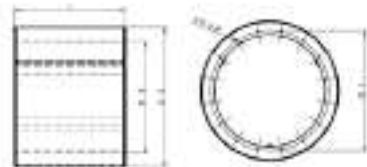

Los silenciadores se utilizan para bajar el nivel sonoro en instalaciones de acondicionamiento o ventilación, fabricados en acero cincado

- Bajo demanda: otras construcciones en diferentes materiales.

øD	øE	L	øI	F	øM
315	515	ØD,1,5ØD, 2ØD	355	8	M8
355	555	ØD,1,5ØD, 2ØD	395	8	M8
400	600	ØD,1,5ØD, 2ØD	450	8	M8
450	650	ØD,1,5ØD, 2ØD	500	8	M8
500	700	ØD,1,5ØD, 2ØD	560	12	M8
560	760	ØD,1,5ØD, 2ØD	620	12	M8
630	830	ØD,1,5ØD, 2ØD	690	12	M8
710	910	ØD,1,5ØD, 2ØD	770	16	M8
800	1000	ØD,1,5ØD, 2ØD	860	16	M8

øD	øE	L	øI	F	øM
900	1100	ØD,1,5ØD, 2ØD	970	16	M10
1000	1200	ØD,1,5ØD, 2ØD	1070	16	M10
1120	1320	ØD,1,5ØD, 2ØD	1190	20	M10
1250	1450	ØD,1,5ØD, 2ØD	1320	20	M10
1400	1600	ØD,1,5ØD, 2ØD	1470	20	M10
1500	1700	ØD,1,5ØD, 2ØD	1570	20	M10
1600	1800	ØD,1,5ØD, 2ØD	1680	24	M14
1700	1900	ØD,1,5ØD, 2ØD	1780	24	M14
1800	2000	ØD,1,5ØD, 2ØD	1880	24	M14

MOTOR DIRECTO

CAMC

Ventiladores centrífugos de media presión y simple aspiración de gran robustez con envolvente y turbina en chapa de acero

Diseñados para aire con polvo



* Las imágenes son solo a nivel ilustrativo, el producto puede variar en función del tamaño, especificaciones y posición.

Ventilador:

- Envolvente en chapa de acero.
- Turbina a reacción, en chapa de acero de gran robustez, especialmente diseñados para aire con mucho polvo y materiales de tamaño reducido.
- Motor directamente acoplado.
- Con trampilla de inspección y limpieza a partir del tamaño 560.

Motor:

- Motores con eficiencia IE3 para potencias iguales o superiores a 0,75 kW, excepto monofásicos, 2 velocidades y 8 polos.
- Motores clase F con rodamientos a bolas. Protección IP55.
- Trifásicos 230/400 V 50 Hz (hasta 4 kW) y 400/690 V 50 Hz (potencias superiores a 4 kW).
- Temperatura máxima del aire a transportar: -25 °C +90 °C.

Acabado:

- Anticorrosivo en resina de poliéster polimerizada a 190 °C, previo desengrase con tratamiento nanotecnológico libre de fosfatos.

Bajo demanda:

- Bobinados especiales para diferentes tensiones.
- Ventilador preparado para transportar aire hasta +150 °C.
- Ejecuciones especiales para temperaturas +300 °C.
- Ventilador en acero inoxidable.
- Certificación ATEX Categoría 2.
- Acoplamiento elástico sistema 8.

Formas constructivas motor directo

SISTEMA 4

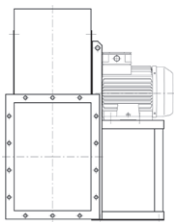

Accionamiento directo, turbina montada en el eje motor, montado sobre la silleta.

SISTEMA 5

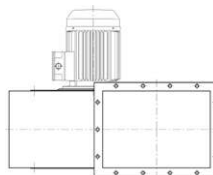

Accionamiento directo, turbina montada en el eje motor, motor de brida montado sobre la carcasa del ventilador.

SISTEMA 8

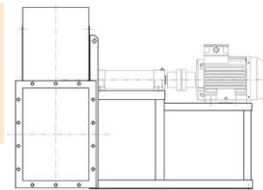

Accionamiento por acoplamiento elástico, turbina montada en el eje soporte, montado al motor mediante acoplamiento elástico. Todo montado conjuntamente sobre la silleta ventilador.

Orientaciones

RD 0 RD45 RD90 RD135 RD180 RD225 RD270 RD315

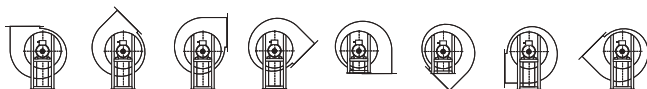

LG 0 LG45 LG90 LG135 LG180 LG225 LG270 LG315

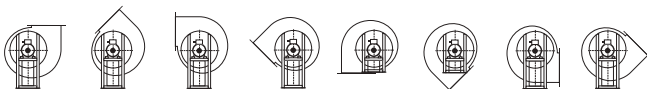

LARGE SERIES

MOTOR A TRANSMISIÓN

CAMC-X

Ventiladores de media presión accionados a transmisión, equipados con motor eléctrico, conjunto de poleas, correas y protectores normalizados según norma ISO-13857
 Diseñados para aire con polvo



Motor:

- Motores con eficiencia IE3.
- Motores clase F con rodamientos a bolas. Protección IP55.
- Trifásicos 230/400 V 50 Hz (hasta 4 kW) y 400/690 V 50 Hz (potencias superiores a 4 kW).
- Temperatura máxima del aire a transportar: -25 °C +90 °C.

Acabado:

- Anticorrosivo en resina de poliéster polimerizada a 190 °C, previo desengrase con tratamiento nanotecnológico libre de fosfatos.

Bajo demanda:

- Bobinados especiales para diferentes tensiones.
- Ventilador preparado para transportar aire hasta +300 °C.
- Ventilador en acero inoxidable.
- Certificación ATEX Categoría 2.
- Acoplamiento elástico sistema 8.

Ventilador:

- Envoltente en chapa de acero.
- Turbina a reacción en chapa de acero de gran robustez, especialmente diseñados para aire con polvo y materiales en suspensión de tamaño reducido.
- Motor montado sobre bancada general.
- Con trampilla de inspección y limpieza a partir del tamaño 560.

* Las imágenes son solo a nivel ilustrativo, el producto puede variar en función del tamaño, especificaciones y posición.

Formas constructivas motor a transmisión

SISTEMA 12

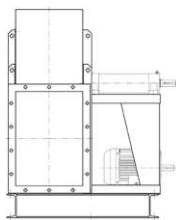

Accionamiento a transmisión, igual al SISTEMA 1, con el motor y ventilador montados en la bancada común. Posiciones de motor "W" o "Z" y excepcionalmente "X" o "Y".

SISTEMA 9

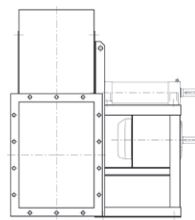

Accionamiento a transmisión, igual al SISTEMA 1, con el motor montado en el lateral de la silleta, en posición "W" o "Z".

SISTEMA 1

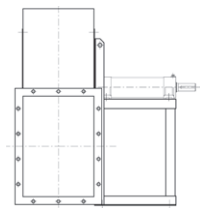

Accionamiento a transmisión, turbina montada en el eje soporte. Soporte montado sobre la silleta.

Orientaciones

RD 0 RD45 RD90 RD135 RD180 RD225 RD270 RD315

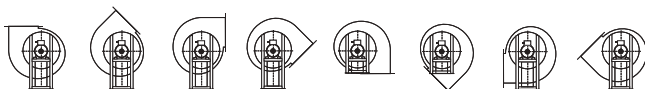

LG 0 LG45 LG90 LG135 LG180 LG225 LG270 LG315

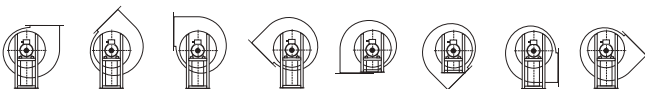

SELECCIÓN RÁPIDA SISTEMA 4

Características en impulsión

MOD.	FRAME	kW ass	kW inst.	r.p.m	dB	V m³/s																		
						0,16	0,18	0,2	0,23	0,26	0,3	0,33	0,36	0,41	0,46	0,51	0,58	0,66	0,75	0,83				
						Pt kgf/m²=mmH₂O																		
CAMC 360	80 B/2	1	1,1	2820	73	238	235	231	223	214	203	190	180	155	130									
CAMC 380	90 S/2	1,3	1,5	2840	76		290	284	280	275	268	262	250	225	202	180								
CAMC 410	90 L/2	2	2,2	2840	79				330	326	319	313	306	292	276	260	237	205						
CAMC 440	100 LA/2	2,8	3	2850	81							390	384	375	362	355	334	294	265					
CAMC 470	112 M/2	3,8	4	2860	82								440	433	425	419	408	392	375	353				
CAMC 500	132 SA/2	5,2	5,5	2900	84												489	481	475	465				
CAMC 520	132 SB/2	7,2	7,5	2900	86															533	524	512		
CAMC 550	160 MA/2	8,8	11	2910	87																		565	

MOD.	FRAME	kW ass	kW inst.	r.p.m	dB	V m³/s											
						0,93	1,05	1,16	1,33	1,5	1,66	1,86	2,08				
						Pt kgf/m²=mmH₂O											
CAMC 470	112 M/2	3,8	4	2860	82	324	275										
CAMC 500	132 SA/2	5,2	5,5	2900	84	445	418	350									
CAMC 520	132 SB/2	7,2	7,5	2900	86	500	482	456	420	370							
CAMC 550	160 MA/2	8,8	11	2910	87	548	524	502	483	458	420	360					
CAMC 560	160 MA/2	10,5	11	2910	89		573	557	538	505	486	452					
CAMC 600	160 MB/2	14,5	15	2930	91				635	624	608	576	550				

Margen sobre el caudal ±5%.
Margen del nivel sonoro +3...5db.

Características en aspiración

MOD.	FRAME	kW ass	kW inst.	r.p.m	dB	V m³/s																		
						0,16	0,18	0,2	0,23	0,26	0,3	0,33	0,36	0,41	0,46	0,51	0,58	0,66	0,75	0,83				
						Pt kgf/m²=mmH₂O																		
CAMC 360	80 B/2	1	1,1	2820	76	214	212	208	201	193	183	171	162	140	117									
CAMC 380	90 S/2	1,3	1,5	2840	78		261	256	252	248	241	236	225	203	182	162								
CAMC 410	90 L/2	2	2,2	2840	82				297	293	287	282	275	263	248	234	213	185						
CAMC 440	100 LA/2	2,8	3	2850	84							351	346	338	326	320	301	265	239					
CAMC 470	112 M/2	3,8	4	2860	85								396	390	383	377	367	353	338	318				
CAMC 500	132 SA/2	5,2	5,5	2900	87												440	433	428	419				
CAMC 520	132 SB/2	7,2	7,5	2900	89															480	472	461		
CAMC 550	160 MA/2	8,8	11	2910	90																		509	

MOD.	FRAME	kW ass	kW inst.	r.p.m	dB	V m³/s											
						0,93	1,05	1,16	1,33	1,5	1,66	1,86	2,08				
						Pt kgf/m²=mmH₂O											
CAMC 470	112 M/2	3,8	4	2860	85	292	248										
CAMC 500	132 SA/2	5,2	5,5	2900	87	401	376	315									
CAMC 520	132 SB/2	7,2	7,5	2900	89	450	434	410	378	333							
CAMC 550	160 MA/2	8,8	11	2910	90	493	472	452	435	412	378	324					
CAMC 560	160 MA/2	10,5	11	2910	92		516	501	484	455	437	407					
CAMC 600	160 MB/2	14,5	15	2930	94				572	562	547	518	495				

Margen sobre el caudal ±5%.
Margen del nivel sonoro +3...5db.

Curvas Características

CAMC 360

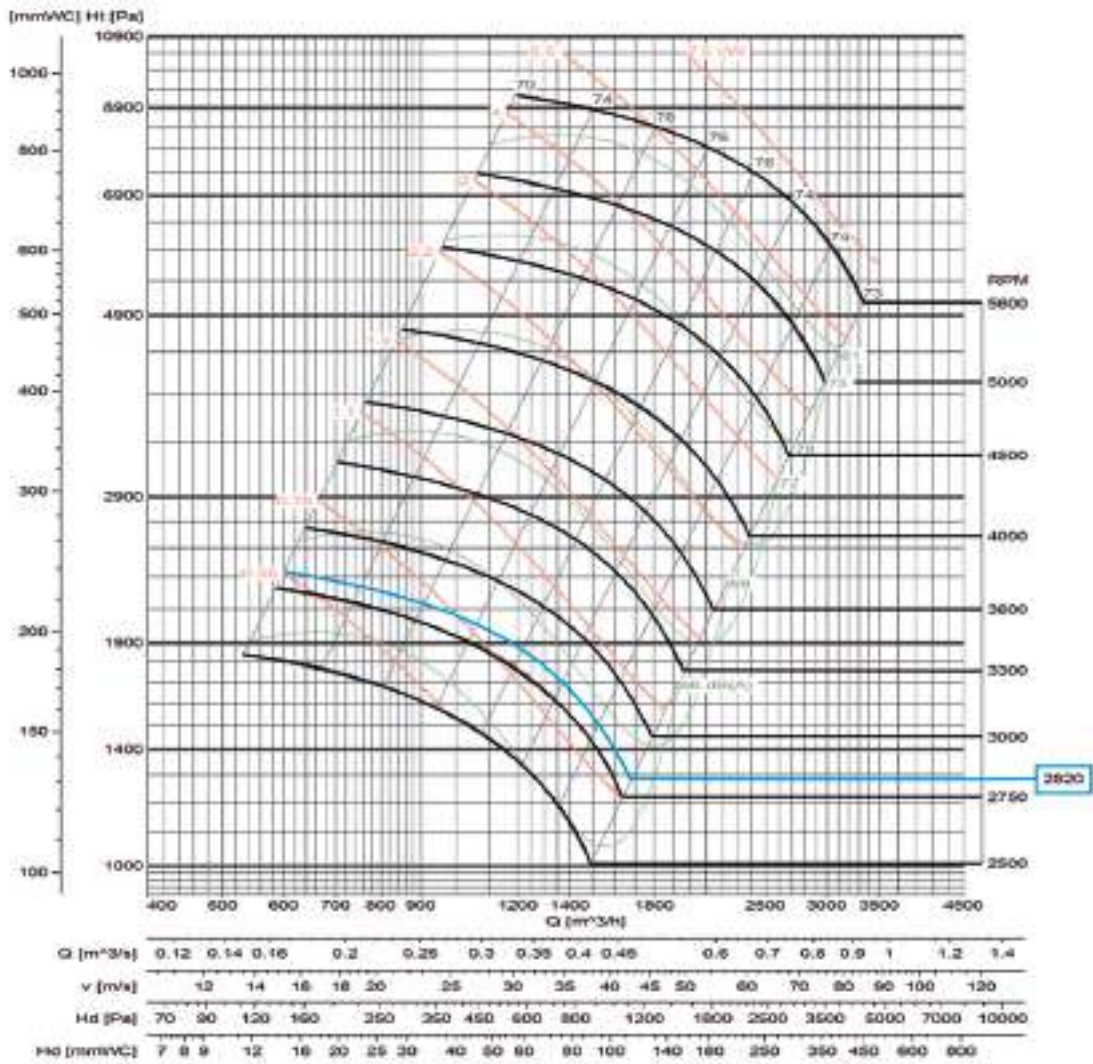

Margen sobre el caudal ± 5 %
 Margen del nivel sonoro +3...5db
 Margen kW absorbidos ± 3%

Características en impulsión.

Rpm

Características para:
 sistema 4 y 5 en motor
 directo con 2/4/6/8 polos
 según modelo.

Curvas Características

CAMC 380

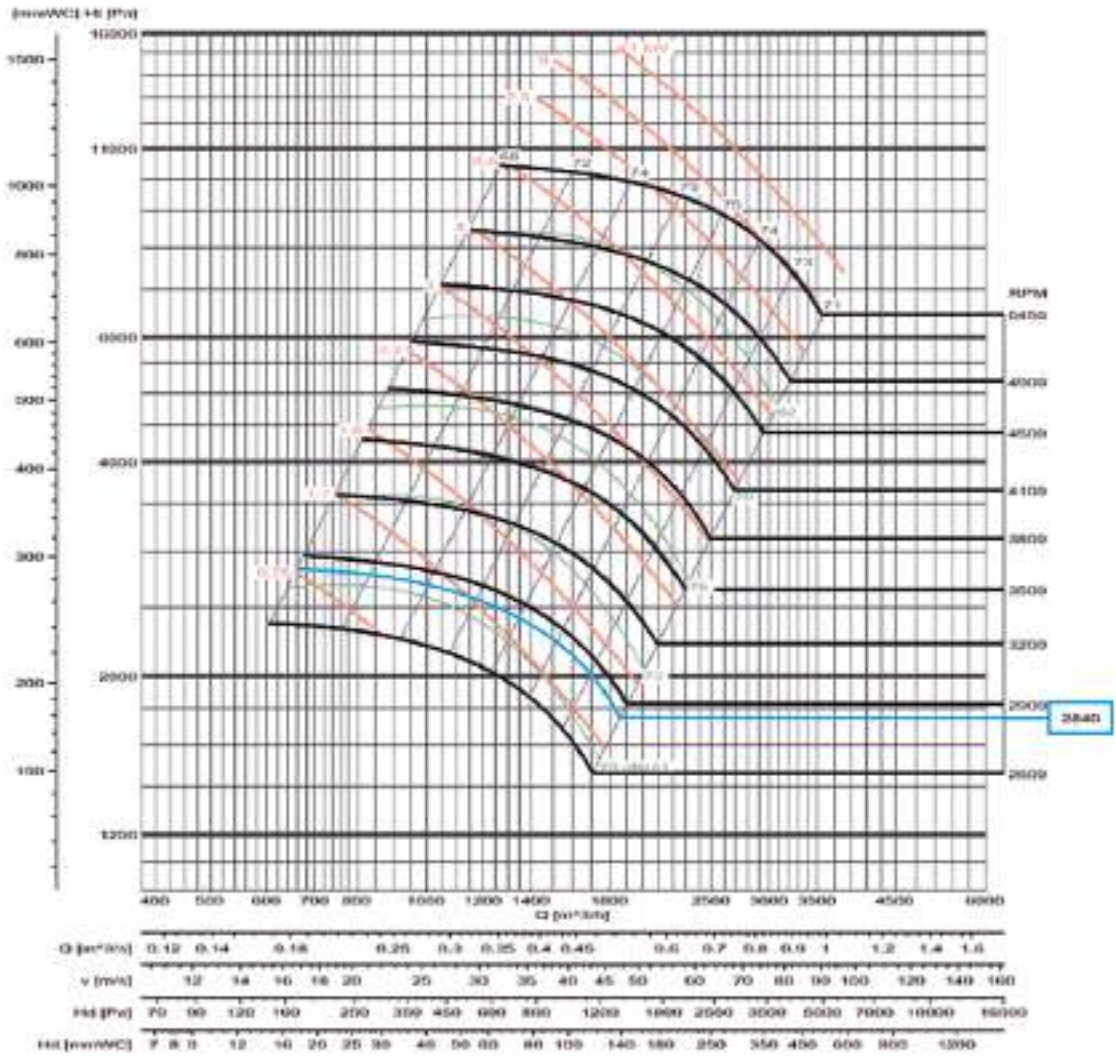

LARGE SERIES

Margen sobre el caudal ± 5 %
 Margen del nivel sonoro +3...5db
 Margen kW absorbidos ± 3%

Características en impulsión.

Rpm

Características para:
 sistema 4 y 5 en motor
 directo con 2/4/6/8 polos
 según modelo.

Curvas Características

CAMC 410

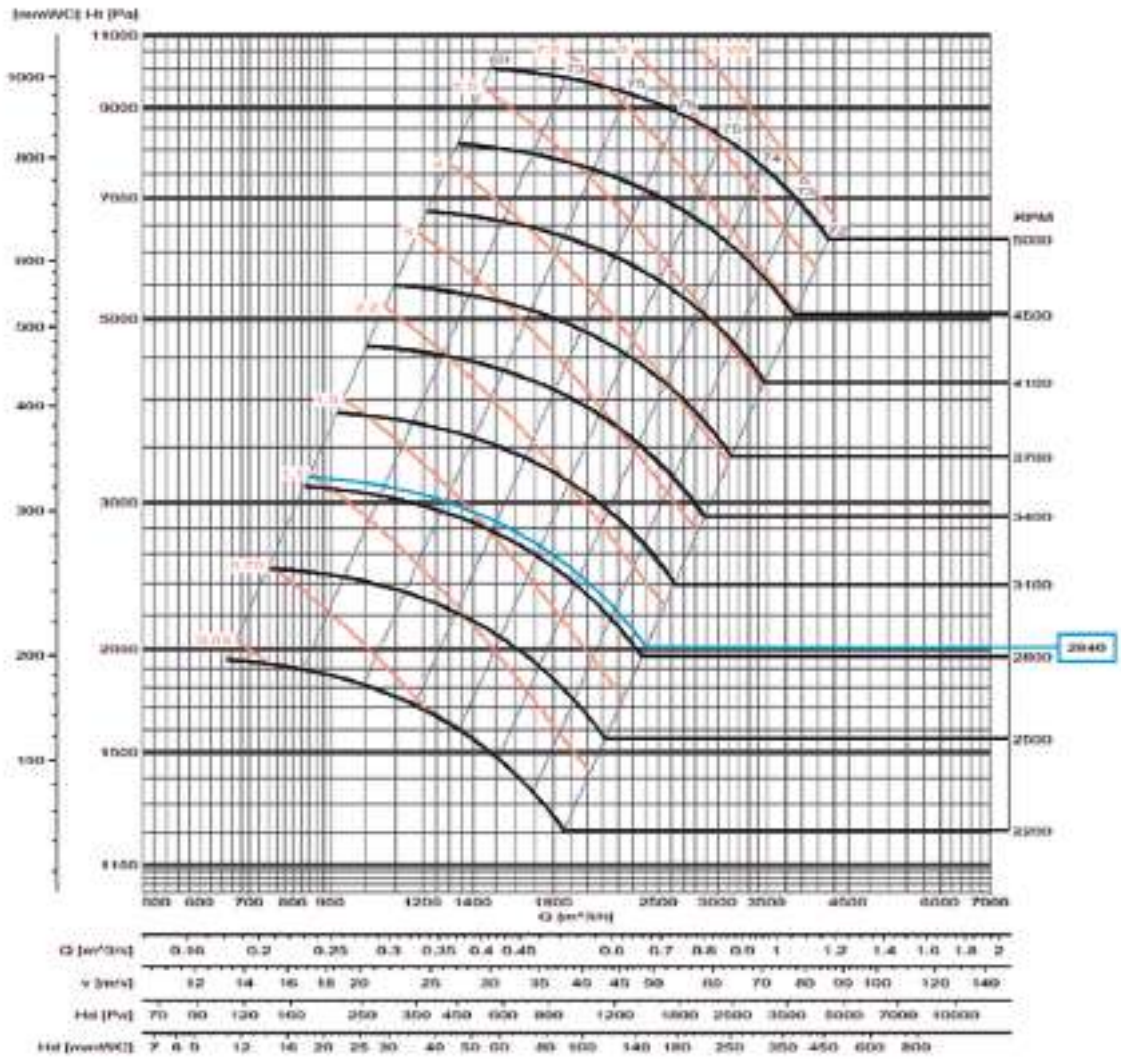

Margen sobre el caudal ± 5 %
 Margen del nivel sonoro +3...5db
 Margen kW absorbidos ± 3%

Características en impulsión.

Rpm

Características para:
 sistema 4 y 5 en motor
 directo con 2/4/6/8 polos
 según modelo.

Curvas Características

CAMC 440

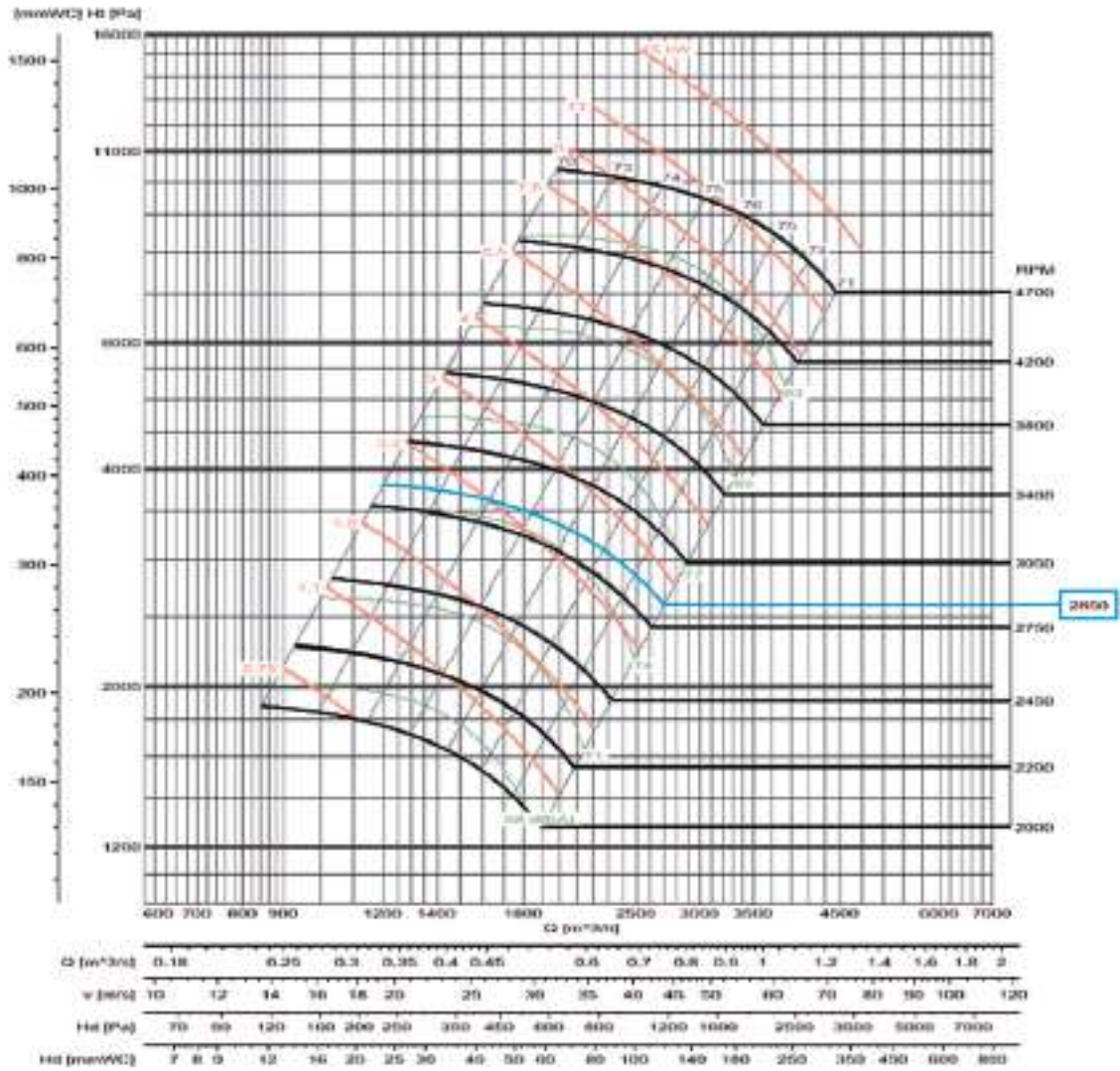

LARGE SERIES

Margen sobre el caudal ± 5 %
 Margen del nivel sonoro +3...5db
 Margen kW absorbidos ± 3%

Características en impulsión.

Rpm Características para:
 sistema 4 y 5 en motor
 directo con 2/4/6/8 polos
 según modelo.

Curvas Características

CAMC 470

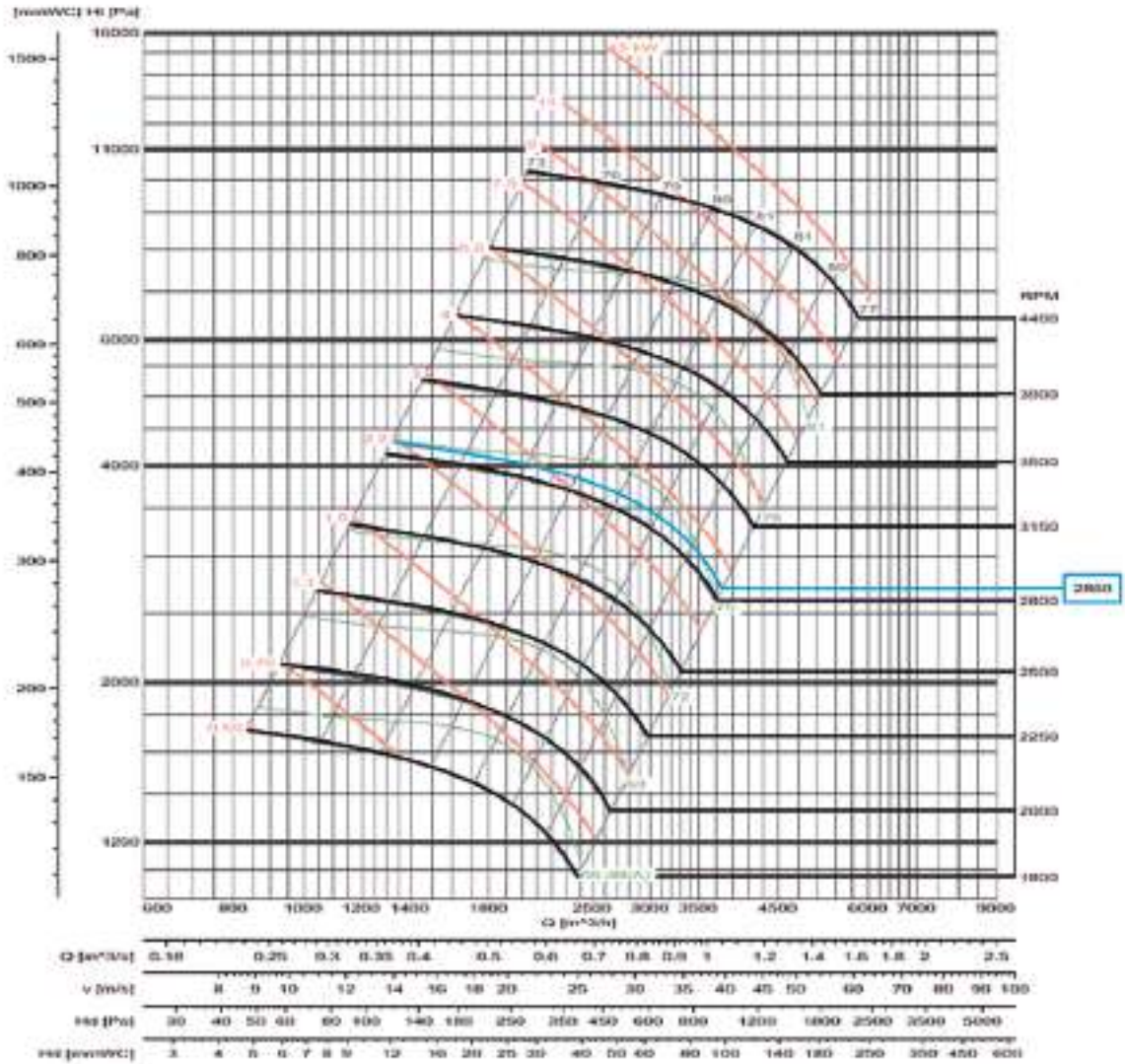

Margen sobre el caudal $\pm 5\%$
 Margen del nivel sonoro $+3...5\text{db}$
 Margen kW absorbidos $\pm 3\%$

Características en impulsión.

Rpm

Características para:
 sistema 4 y 5 en motor
 directo con 2/4/6/8 polos
 según modelo.

Curvas Características

CAMC 500

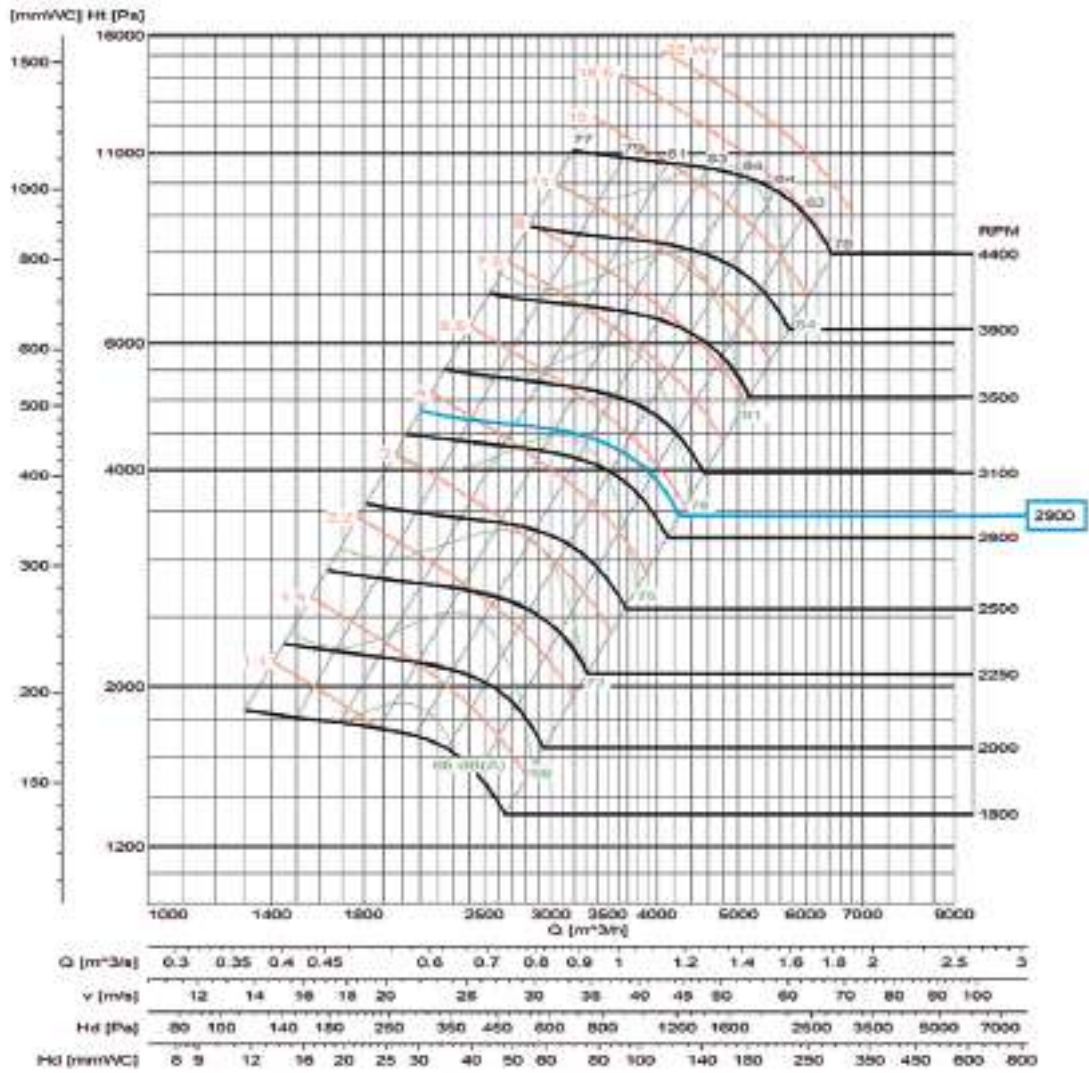

LARGE SERIES

Margen sobre el caudal ± 5 %
 Margen del nivel sonoro +3...5db
 Margen kW absorbidos ± 3%

Características en impulsión.

Rpm

Características para:
 sistema 4 y 5 en motor
 directo con 2/4/6/8 polos
 según modelo.

Curvas Características

CAMC 520

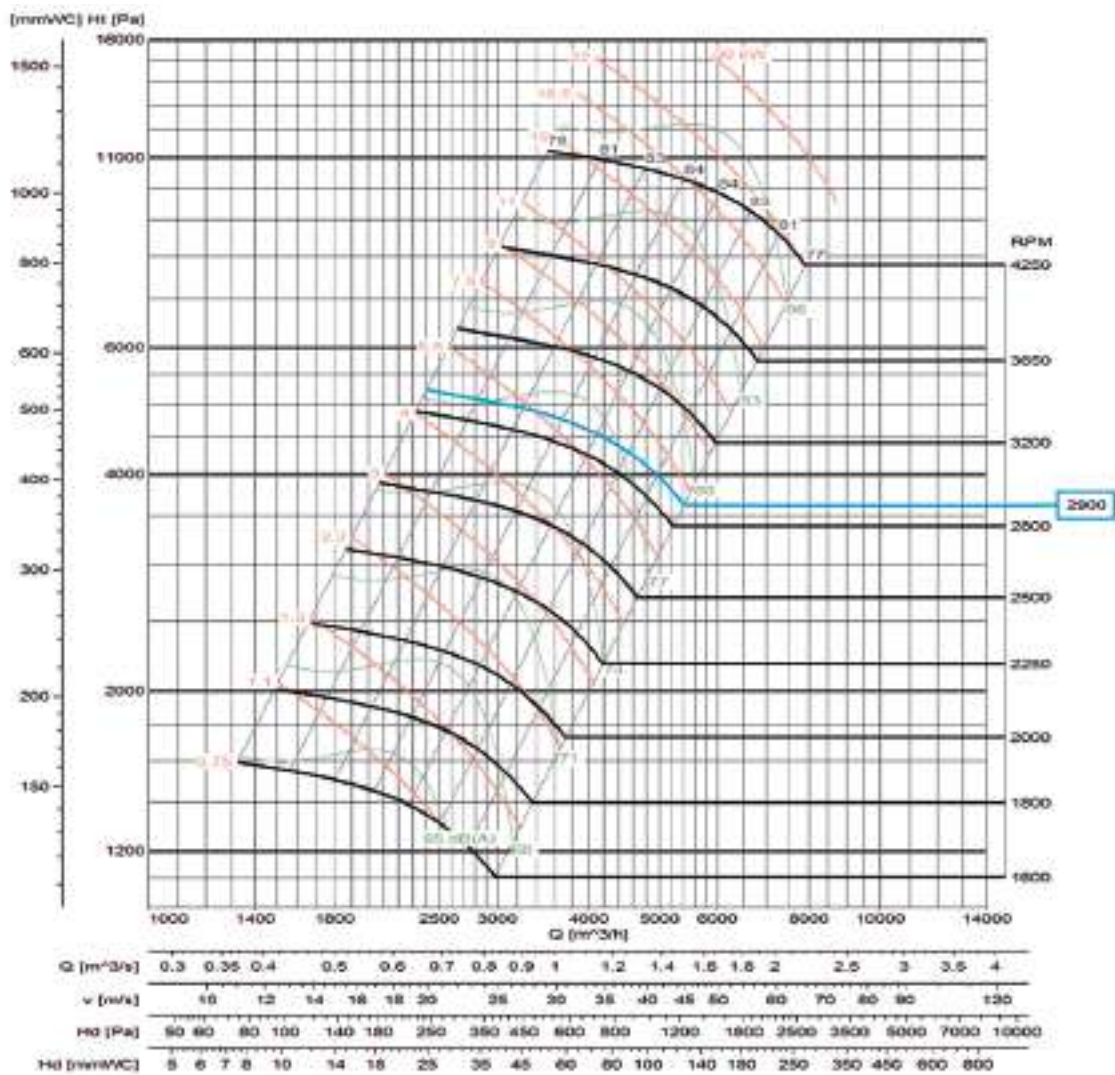

Margen sobre el caudal $\pm 5\%$
 Margen del nivel sonoro $+3...5\text{db}$
 Margen kW absorbidos $\pm 3\%$

Características en impulsión.

Rpm

Características para:
 sistema 4 y 5 en motor
 directo con 2/4/6/8 polos
 según modelo.

Curvas Características

CAMC 550

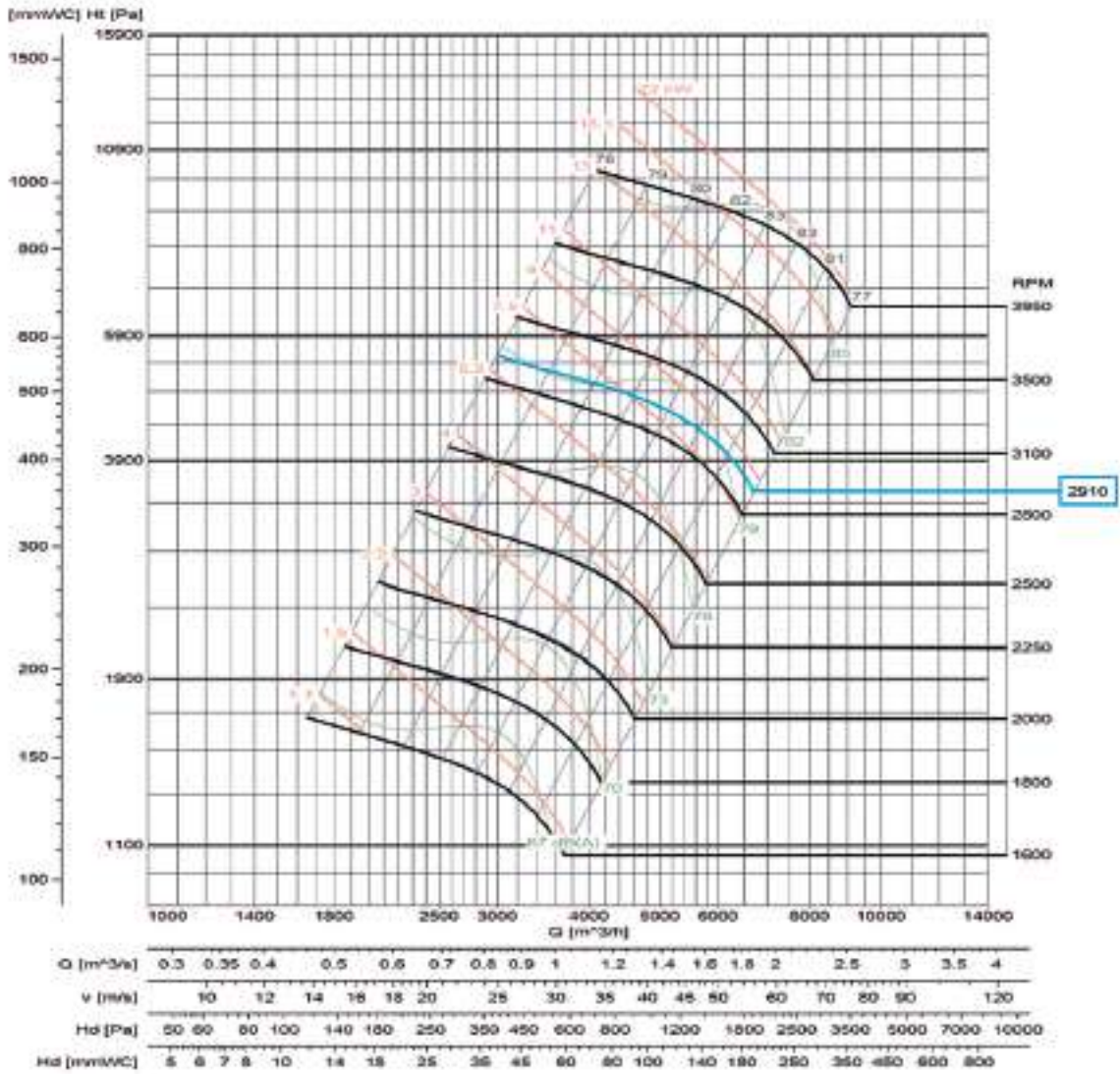

LARGE SERIES

Margen sobre el caudal ± 5 %
 Margen del nivel sonoro +3...5db
 Margen kW absorbidos ± 3%

Características en impulsión.

Rpm Características para:
 sistema 4 y 5 en motor
 directo con 2/4/6/8 polos
 según modelo.

Curvas Características

CAMC 560

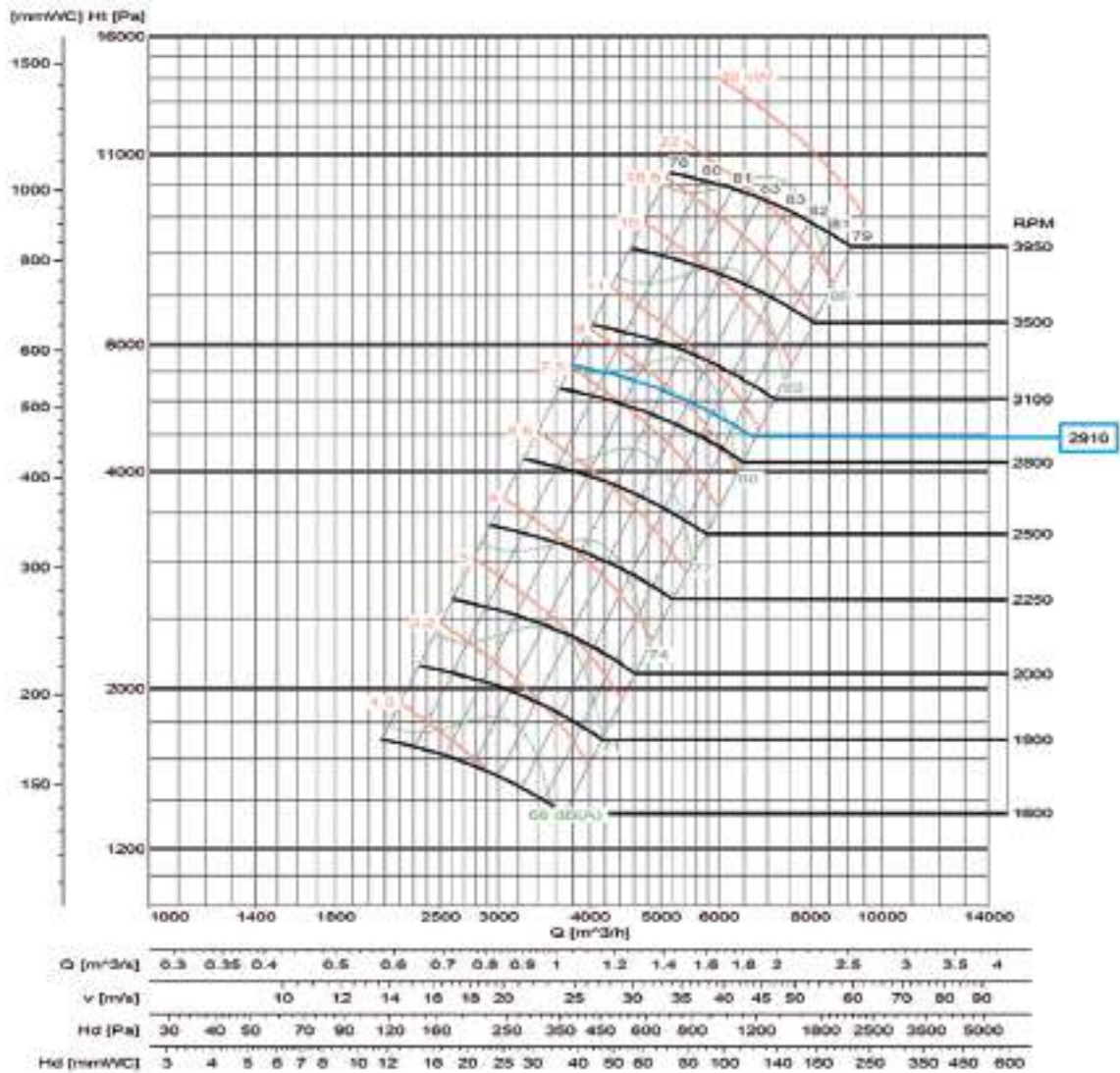

Margen sobre el caudal $\pm 5\%$
 Margen del nivel sonoro $+3...5\text{db}$
 Margen kW absorbidos $\pm 3\%$

Características en impulsión.

Rpm

Características para:
 sistema 4 y 5 en motor
 directo con 2/4/6/8 polos
 según modelo.

Curvas Características

CAMC 600

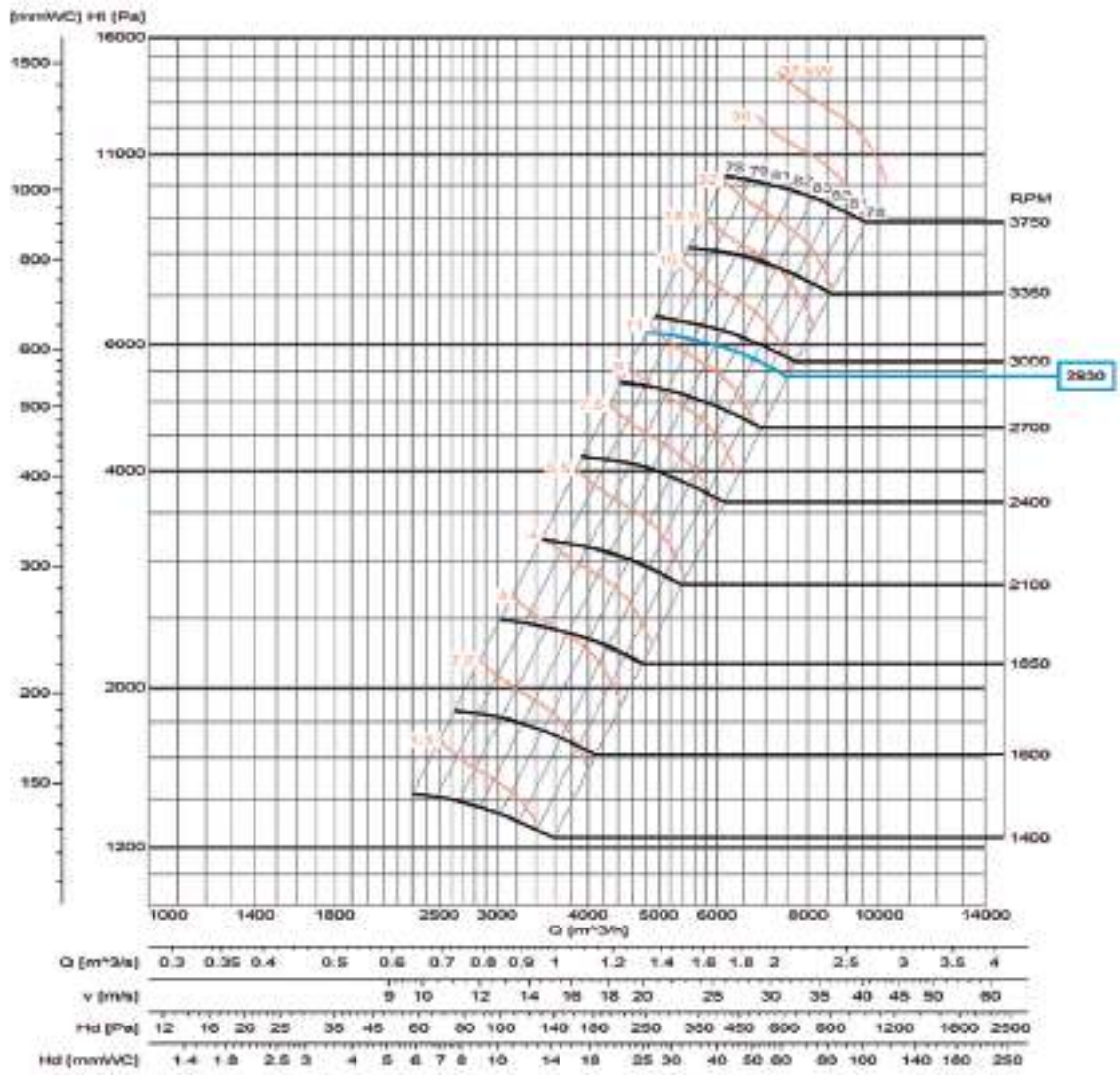

LARGE SERIES

Margen sobre el caudal ± 5 %
 Margen del nivel sonoro +3...5db
 Margen kW absorbidos ± 3%

Características en impulsión.

Rpm

Características para:
 sistema 4 y 5 en motor
 directo con 2/4/6/8
 según modelo.

Dimensiones mm

SISTEMA
4

CAMC 360...600

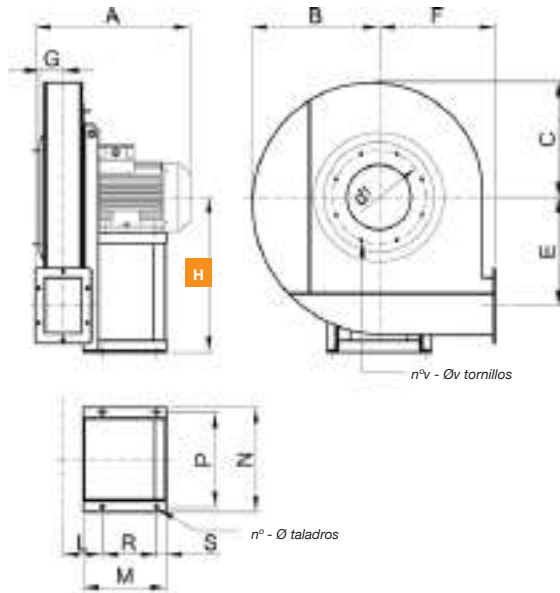

BOCA DE IMPULSIÓN

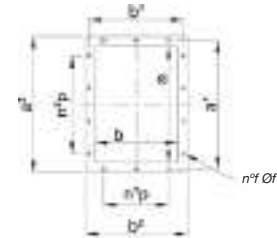

ORIENTACIONES

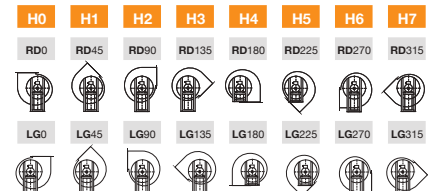

H * La medida de la cota H (distancia entre el suelo y el eje) varía según las orientaciones

MOD.	FRAME	A*	B	C	E	F	G	H0-1-2-3	H4-5	H6-7	L	M*	N	P	R*	S
CAMC 360	80 B/2	365	305	275	260	280	53	355	280	355	95	190	244	220	115	25
CAMC 380	90 S/2	380	305	275	260	280	53	355	280	355	95	215	269	245	140	25
CAMC 410	90 L/2	415	330	300	280	300	60	400	300	400	101	215	269	245	140	25
CAMC 440	100 LA/2	455	390	350	335	355	65	450	355	450	106	260	312	280	185	25
CAMC 470	112 M/2	485	420	380	355	375	77	500	375	500	119	260	312	280	185	25
CAMC 500	132 SA/2	575	420	380	355	375	77	500	375	500	119	320	342	310	245	25
CAMC 520	132 SB/2	590	480	453	400	420	85	560	420	560	127	320	342	310	245	25
CAMC 550	160 MA/2	615	480	453	400	420	85	560	420	560	127	320	342	310	245	25
CAMC 560	160 MA/2	680	495	445	410	430	93	580	430	580	137	425	440	400	345	30
CAMC 600	160 MB/2	800	515	460	450	450	110	665	450	665	157	425	440	400	345	30

BOCA IMPULSIÓN

MOD.	n°	Φ	d ¹	n°v	Φv	a	b	a ¹	b ¹	a ²	b ²	n°p	n°p	n°f	Φf	kg	WD ²
CAMC 360	4	10	200	8	M6	129	84	161	116	179	134	-	1-90	6	8	35	0,3
CAMC 380	4	10	200	8	M6	129	84	161	116	179	134	-	1-90	6	8	45	0,35
CAMC 410	4	10	241	8	M6	144	95	176	126	194	145	-	1-90	6	8	55	0,5
CAMC 440	4	12	241	8	M6	164	105	194	135	214	155	1-90	1-90	8	8	70	0,8
CAMC 470	4	12	292	8	M8	204	130	235	161	264	190	1-90	2-90	10	10	90	1,35
CAMC 500	4	12	292	8	M8	204	130	235	161	264	190	1-90	2-90	10	10	120	1,7
CAMC 520	4	12	332	8	M8	229	146	259	176	289	206	1-90	2-90	10	10	140	2
CAMC 550	4	12	332	8	M8	229	146	259	176	289	206	1-90	2-90	10	10	155	2,5
CAMC 560	4	14	366	8	M8	255	166	286	194	315	226	1-90	2-90	10	10	200	2,7
CAMC 600	4	14	366	8	M8	320	206	356	235	380	266	1-100	3-100	12	10	235	3,3

(*) Para construcciones a "ALTA TEMP" cotas *A-M-R*+50mm.
(kg) Peso ventilador con motor.
WD² = Momento de inercia del rodete, expresado en Kg x m²

Para obtener las dimensiones de los sistemas 1, 9 y 12 consultar a nuestro equipo técnico.

Accesorios

Contrabrida aspiración

n° - Ø taladros

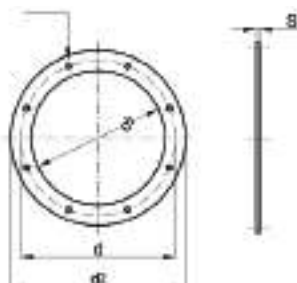

MOD.	d	d'	d''	n°	Φ	s	kg
CAMC 360	200	165	235	8	9	4	0,65
CAMC 380	200	165	235	8	9	4	0,65
CAMC 410	241	205	275	8	9	4	0,75
CAMC 440	241	205	275	8	9	4	0,75
CAMC 470	292	255	325	8	11	4	1
CAMC 500	292	255	325	8	11	4	1
CAMC 520	332	286	366	8	11	5	1,6
CAMC 550	332	286	366	8	11	5	1,6
CAMC 560	366	321	401	8	11	5	1,8
CAMC 600	366	321	401	8	11	5	1,8

Contrabrida impulsión

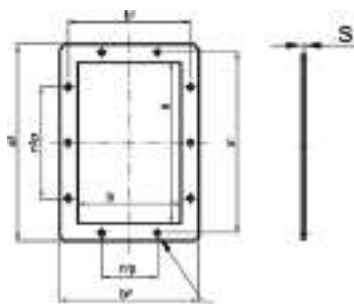

n° - Ø taladros

MOD.	a	b	a'	b'	a''	b''	n°p	n°p	n°	Φ	s	kg
CAMC 360	129	85	161	116	179	135	-	1--90	6	8	4	0,4
CAMC 380	129	85	161	116	179	135	-	1--90	6	8	4	0,4
CAMC 410	144	95	176	126	194	145	-	1--90	6	8	4	0,45
CAMC 440	164	105	194	135	214	155	1--90	1--90	8	8	4	0,5
CAMC 470	204	130	235	161	264	190	1--90	2--90	10	10	4	0,7
CAMC 500	204	130	235	161	264	190	1--90	2--90	10	10	4	0,7
CAMC 520	229	146	259	176	289	206	1--90	2--90	10	10	4	0,8
CAMC 550	229	146	259	176	289	206	1--90	2--90	10	10	4	0,8
CAMC 560	255	166	286	194	315	226	1--90	2--90	10	10	4	0,9
CAMC 600	320	206	356	235	380	266	1-100	3-100	12	10	4	1

Red protección en aspiración

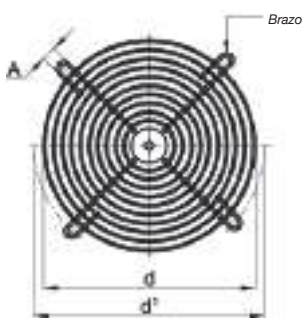

MOD.	d	d'	A	n°	kg
CAMC 360	165	200	9	4	0,15
CAMC 380	165	200	9	4	0,15
CAMC 410	205	241	9	4	0,2
CAMC 440	205	241	9	4	0,2
CAMC 470	255	292	11	4	0,3
CAMC 500	255	292	11	4	0,3
CAMC 520	286	332	11	4	0,35
CAMC 550	286	332	11	4	0,35
CAMC 560	321	366	11	4	0,4
CAMC 600	321	366	11	4	0,4

Junta anti vibratoria en aspiración

n° - Ø taladros

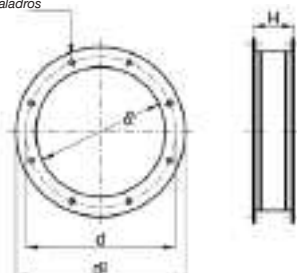

MOD.	d	d'	d''	n°	Φ	H	kg
CAMC 360	200	165	235	8	9	200	1,5
CAMC 380	200	165	235	8	9	200	1,5
CAMC 410	241	205	275	8	9	200	1,7
CAMC 440	241	205	275	8	9	200	1,7
CAMC 470	292	255	325	8	11	200	2,2
CAMC 500	292	255	325	8	11	200	2,2
CAMC 520	332	286	366	8	11	200	3,4
CAMC 550	332	286	366	8	11	200	3,4
CAMC 560	366	321	401	8	11	200	3,8
CAMC 600	366	321	401	8	11	200	3,8

LARGE SERIES

Accesorios

Junta anti vibratoria en impulsión

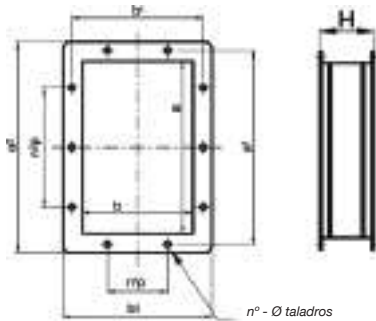

MOD.	a	b	a'	b'	a²	b²	n°p	n²p	n°	Ø	H	kg
CAMC 360	129	85	161	116	179	135	-	1--90	6	8	200	1
CAMC 380	129	85	161	116	179	135	-	1--90	6	8	200	1
CAMC 410	144	95	176	126	194	145	-	1--90	6	8	200	1,1
CAMC 440	164	105	194	135	214	155	1--90	1--90	8	8	200	1,2
CAMC 470	204	130	235	161	264	190	1--90	2--90	10	10	200	1,6
CAMC 500	204	130	235	161	264	190	1--90	2--90	10	10	200	1,6
CAMC 520	229	146	259	176	289	206	1--90	2--90	10	10	200	1,8
CAMC 550	229	146	259	176	289	206	1--90	2--90	10	10	200	1,8
CAMC 560	255	166	286	194	315	226	1--90	2--90	10	10	200	2
CAMC 600	320	206	356	235	380	266	1-100	3-100	12	10	200	2,2

Amortiguadores

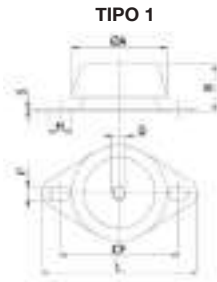

MOD.	MODELO AMORTIGUADORES	TIPO	ØA	B	D	CF	F	L	M	S
CAMC 360	CF 623110	1	67	33...34	10	76,5	9	90,5	16	2
CAMC 380	CF 623110	1	67	33...34	10	76,5	9	90,5	16	2
CAMC 410	CF 623110	1	67	33...34	10	76,5	9	90,5	16	2
CAMC 440	CF 623110	1	67	33...34	10	76,5	9	90,5	16	2
CAMC 470	CF 623110	1	67	33...34	10	76,5	9	90,5	16	2
CAMC 500	CF 623110	1	67	33...34	10	76,5	9	90,5	16	2
CAMC 520	CF 623110	1	67	33...34	10	76,5	9	90,5	16	2
CAMC 550	CF 623110	1	67	33...34	10	76,5	9	90,5	16	2
CAMC 560	CF 623110	1	67	33...34	10	76,5	9	90,5	16	2
CAMC 600	CF 623110	1	67	33...34	10	76,5	9	90,5	16	2

Silenciadores circulares



Los silenciadores se utilizan para bajar el nivel sonoro en instalaciones de acondicionamiento o ventilación, fabricados en acero cincado

- Bajo demanda: otras construcciones en diferentes materiales.

ØD	ØE	L	ØI	F	ØM	ØD	ØE	L	ØI	F	ØM
315	515	ØD,1,5ØD, 2ØD	355	8	M8	900	1100	ØD,1,5ØD, 2ØD	970	16	M10
355	555	ØD,1,5ØD, 2ØD	395	8	M8	1000	1200	ØD,1,5ØD, 2ØD	1070	16	M10
400	600	ØD,1,5ØD, 2ØD	450	8	M8	1120	1320	ØD,1,5ØD, 2ØD	1190	20	M10
450	650	ØD,1,5ØD, 2ØD	500	8	M8	1250	1450	ØD,1,5ØD, 2ØD	1320	20	M10
500	700	ØD,1,5ØD, 2ØD	560	12	M8	1400	1600	ØD,1,5ØD, 2ØD	1470	20	M10
560	760	ØD,1,5ØD, 2ØD	620	12	M8	1500	1700	ØD,1,5ØD, 2ØD	1570	20	M10
630	830	ØD,1,5ØD, 2ØD	690	12	M8	1600	1800	ØD,1,5ØD, 2ØD	1680	24	M14
710	910	ØD,1,5ØD, 2ØD	770	16	M8	1700	1900	ØD,1,5ØD, 2ØD	1780	24	M14
800	1000	ØD,1,5ØD, 2ØD	860	16	M8	1800	2000	ØD,1,5ØD, 2ØD	1880	24	M14

MOTOR DIRECTO

CAMD

Ventiladores centrífugos de media presión y simple aspiración de gran robustez con envolvente y turbina en chapa de acero
Diseñados para aire con polvo



* Las imágenes son solo a nivel ilustrativo, el producto puede variar en función del tamaño, especificaciones y posición.

Ventilador:

- Envolvente en chapa de acero.
- Turbina a reacción, en chapa de acero de gran robustez, especialmente diseñados para aire con mucho polvo y materiales de tamaño reducido.
- Motor directamente acoplado.
- Con trampilla de inspección y limpieza a partir del tamaño 560.
- Los tamaños superiores a 1600, se suministran con carcasa partida para facilitar el transporte.

- Carcasa soldada en continuo a partir del tamaño 710.

Motor:

- Motores con eficiencia IE3 para potencias iguales o superiores a 0,75 kW, excepto monofásicos, 2 velocidades y 8 polos.
- Motores clase F con rodamientos a bolas. Protección IP55.
- Trifásicos 230/400 V 50 Hz (hasta 4 kW) y 400/690 V 50 Hz (potencias superiores a 4 kW).
- Temperatura máxima del aire a transportar: -25 °C +90 °C.

Acabado:

- Anticorrosivo en resina de poliéster polimerizada a 190 °C, previo desengrase con tratamiento nanotecnológico libre de fosfatos.

Bajo demanda:

- Bobinados especiales para diferentes tensiones.
- Ventilador preparado para transportar aire hasta +150 °C.
- Ejecuciones especiales para temperaturas +300 °C.
- Ventilador en acero inoxidable.
- Certificación ATEX Categoría 2.
- Acoplamiento elástico sistema 8.

Formas constructivas motor directo

SISTEMA 4

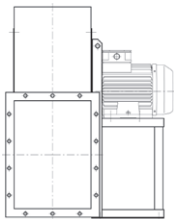

Accionamiento directo, turbina montada en el eje motor, montado sobre la silleta.

SISTEMA 5

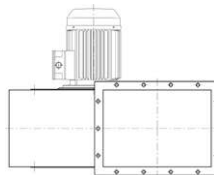

Accionamiento directo, turbina montada en el eje motor, motor de brida montado sobre la carcasa del ventilador.

SISTEMA 8

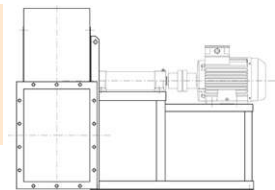

Accionamiento por acoplamiento elástico, turbina montada en el eje soporte, montado al motor mediante acoplamiento elástico. Todo montado conjuntamente sobre la silleta ventilador.

Orientaciones

RD 0 RD45 RD90 RD135 RD180 RD225 RD270 RD315

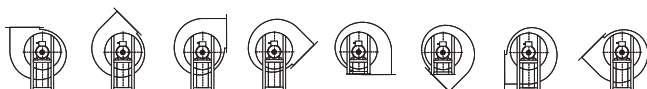

LG 0 LG45 LG90 LG135 LG180 LG225 LG270 LG315

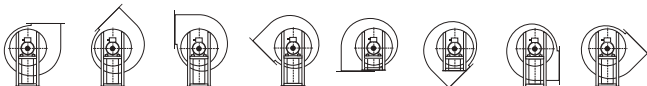

LARGE SERIES

MOTOR A TRANSMISIÓN

CAMD-X

Ventiladores de media presión accionados a transmisión, equipados con motor eléctrico, conjunto de poleas, correas y protectores normalizados según norma ISO-13857

Diseñados para aire con polvo



* Las imágenes son solo a nivel ilustrativo, el producto puede variar en función del tamaño, especificaciones y posición.

Ventilador:

- Envoltente en chapa de acero.
- Turbina a reacción, en chapa de acero de gran robustez, especialmente diseñados para aire con mucho polvo y materiales de tamaño reducido.
- Motor montado sobre bancada general.
- Con trampilla de inspección y limpieza a partir del tamaño 560.
- Los tamaños superiores a 1600, se suministran con carcasa partida para facilitar el transporte.

- Carcasa soldada en continuo a partir del tamaño 710.

Motor:

- Motores con eficiencia IE3.
- Motores clase F con rodamientos a bolas. Protección IP55.
- Trifásicos 230/400 V 50 Hz (hasta 4 kW) y 400/690 V 50 Hz (potencias superiores a 4 kW).
- Temperatura máxima del aire a transportar: -25 °C +90 °C.

Acabado:

- Anticorrosivo en resina de poliéster polimerizada a 190 °C, previo desengrase con tratamiento nanotecnológico libre de fosfatos.

Bajo demanda:

- Bobinados especiales para diferentes tensiones.
- Ventilador preparado para transportar aire hasta +300 °C.
- Ventilador en acero inoxidable.
- Certificación ATEX Categoría 2.
- Acoplamiento elástico sistema 8.

Formas constructivas motor a transmisión

SISTEMA 12

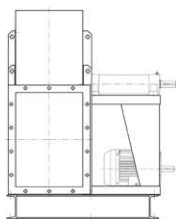

Accionamiento a transmisión, igual al SISTEMA 1, con el motor y ventilador montados en la bancada común. Posiciones de motor "W" o "Z" y excepcionalmente "X" o "Y".

SISTEMA 9

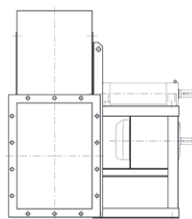

Accionamiento a transmisión, igual al SISTEMA 1, con el motor montado en el lateral de la silleta, en posición "W" o "Z".

SISTEMA 1

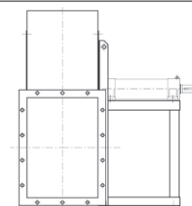

Accionamiento a transmisión, turbina montada en el eje soporte. Soporte montado sobre la silleta.

Orientaciones

RD 0 RD45 RD90 RD135 RD180 RD225 RD270 RD315

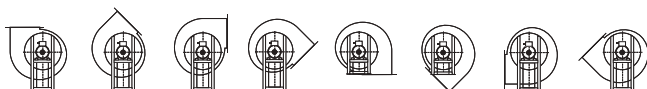

LG 0 LG45 LG90 LG135 LG180 LG225 LG270 LG315

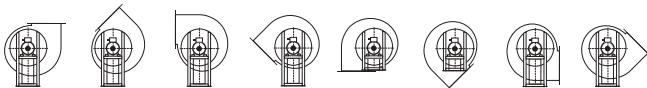

SELECCIÓN RÁPIDA SISTEMA 4

Características en impulsión

Modelo	Frame	kW abs	kW inst.	r.p.m.	dB	V m³/s															
						0,35	0,4	0,45	0,55	0,6	0,65	0,75	0,85	0,95	1,05	1,2	1,3	1,5	1,7	1,9	
						Pt kgf/m²=mmH₂O															
CAMD 400/B	90 L/2	2	2,2	2840	75	225	225	223	220	210	200	190	180								
CAMD 400/A	100 LA/2	2,6	3	2850	76	270	270	265	260	255	250	235	220	205	190	140	115				
CAMD 450/B	112 M/2	3,7	4	2860	78				305	305	300	295	290	280	275	260					
CAMD 450/A	132 SA/2	4,4	5,5	2900	84				350	350	345	340	335	325	310	290	270	240	190	130	
CAMD 500/B	132 SB/2	6,4	7,5	2900	85							380	380	375	370	365	355	330	300		
CAMD 500/A	160 MA/2	7,6	11	2910	87							440	440	435	430	420	405	385	365	335	
CAMD 560/B	160 MA/2	10,6	11	2910	88										490	485	480	475	465	450	
CAMD 560/A	160 MB/2	13,5	15	2930	88										560	555	550	545	535	510	
CAMD 630/B	180 MB/2	20	22	2950	88													635	630	625	
CAMD 630/A	200 LA/2	26	30	2950	90													725	720	715	
CAMD 560/B	90 L/4	1,4	1,5	1380	68				120	120	118	115	114	112	105	95					
CAMD 560/A	100 LA/4	1,8	2,2	1410	69				135	135	132	130	128	125	120	115	105	100	75	60	
CAMD 630/B	100 LB/4	2,7	3	1410	70							160	160	158	155	150	145	140	130		
CAMD 630/A	112 M/4	3,5	4	1420	71							180	180	178	175	170	165	160	150	140	
CAMD 710/B	112 M/4	3,9	4	1420	72										195	194	190	185	180	175	
CAMD 710/A	132 S/4	5,4	5,5	1430	73										220	218	215	212	210	200	
CAMD 800/B	132 MA/4	7,4	7,5	1430	75													240	240	235	
CAMD 800/A	160 M/4	10	11	1465	78													282	280	280	
CAMD 900/B	132 MA/6	3,9	4	950	68													130	130	128	127
CAMD 900/A	132 MB/6	5	5,5	950	69													150	150	145	143
CAMD 1000/B	160 M/6	6,5	7,5	960	70																165
CAMD 1000/A	160 L/6	8,7	11	960	71																190

Margen sobre el caudal ±5%
Margen del nivel sonoro +3...5db

Modelo	Frame	kW abs	kW inst.	r.p.m.	dB	V m³/s															
						2,1	2,3	2,7	3	3,3	3,7	4,2	4,7	5,3	6	6,5	7,5	8,5	9,5	10,5	
						Pt kgf/m²=mmH₂O															
CAMD 500/A	160 MA/2	7,6	11	2910	87	300	260	160													
CAMD 560/B	160 MA/2	10,6	11	2910	88	420	405														
CAMD 560/A	160 MB/2	13,5	15	2930	88	500	475	425	375												
CAMD 630/B	180 MB/2	20	22	2950	88	615	605	585	550	505											
CAMD 630/A	200 LA/2	26	30	2950	90	705	695	670	640	600	550	490	400	300							
CAMD 710/B	200 LB/2	36	37	2960	91	800	790	785	765	750	740	700	660								
CAMD 710/A	225 M/2	44	45	2960	92	905	903	900	880	860	850	815	760	700	625	550	380				
CAMD 800/B	280 S/2	64	75	2970	93				1050	1040	1025	1020	1000	970	920	850					
CAMD 800/A	280 M/2	84	90	2970	94				1200	1180	1175	1160	1140	1100	1050	1000	950	800	650	500	
CAMD 900/B	315 MA/2	116	132	2980	96							1320	1310	1300	1280	1250	1220	1180	1050		
CAMD 900/A	315 MB/2	150	160	2980	98							1500	1490	1480	1450	1420	1400	1350	1250	1180	
CAMD 630/A	112 M/4	3,5	4	1420	71	120	105	75													
CAMD 710/B	112 M/4	3,9	4	1420	72	175															
CAMD 710/A	132 S/4	5,4	5,5	1430	73	190	180	170	150	120											
CAMD 800/B	132 MA/4	7,4	7,5	1430	75	225	220	215	210												
CAMD 800/A	160 M/4	10	11	1465	78	275	270	260	250	240	220	200	160	120							
CAMD 900/B	160 L/4	14	15	1465	80		320	318	315	310	300	290	270								
CAMD 900/A	180 L/4	20	22	1470	82		370	365	360	350	340	330	315	290	260	220	160				
CAMD 1000/B	200 L/4	26	30	1470	84				390	390	380	375	370	360	350	330					
CAMD 1000/A	225 S/4	32	37	1480	86				455	452	450	440	430	425	400	380	350	300	250	180	
CAMD 1120/B	225 M/4	44	45	1480	87							500	490	485	475	470	460	400	380		
CAMD 1120/A	250 M/4	54	55	1480	89							575	570	565	555	550	540	500	475	450	
CAMD 1250/B	280 S/4	74	75	1485	90										630	630	620	620	610	590	
CAMD 1250/A	315 S/4	98	110	1485	92										730	725	720	710	680	660	
CAMD 1400/B	315 MA/4	130	132	1485	94													800	795	790	
CAMD 1400/A	315 MC/4	170	200	1485	95													920	920	910	

Margen sobre el caudal ±5%
Margen del nivel sonoro +3...5db

LARGE SERIES

SELECCIÓN RÁPIDA SISTEMA 4

Características en impulsión

Modelo	Frame	kW abs	kW inst.	r.p.m.	dB	V m ³ /s																
						2,1	2,3	2,7	3	3,3	3,7	4,2	4,7	5,3	6	6,5	7,5	8,5	9,5	10,5		
						Pt kgf/m ² =mmH ₂ O																
CAMD 900/B	132 MA/6	3,9	4	950	68	125	120	115	105													
CAMD 900/A	132 MB/6	5	5,5	950	69	140	138	135	125	115	100	80	60									
CAMD 1000/B	160 M/6	6,5	7,5	960	70	163	160	158	155	154	145	135										
CAMD 1000/A	160 L/6	8,7	11	960	71	188	188	185	180	170	165	160	145	130	100	75						
CAMD 1120/B	180 L/6	12	15	970	74			215	213	210	208	205	200	185	180							
CAMD 1120/A	200 LA/6	15	18,5	975	75			250	245	240	235	230	225	220	205	190	170	150	100			
CAMD 1250/B	200 LB/6	20	22	975	76						270	265	260	258	255	245	235	210				
CAMD 1250/A	225 M/6	27	30	980	77						320	315	310	305	295	285	275	265	245	230		
CAMD 1400/B	250 M/6	36	37	980	80											345	340	335	330	325	315	300
CAMD 1400/A	280 M/6	49	55	985	81											400	395	390	385	380	370	350

Margen sobre el caudal ±5%
Margen del nivel sonoro +3...5db

Modelo	Frame	kW abs	kW inst.	r.p.m.	dB	V m ³ /s															
						12	13	15	17	19	21	23	27	30							
						Pt kgf/m ² =mmH ₂ O															
CAMD 900/A	315 MB/2	150	160	2980	98	1075	950	620													
CAMD 1120/A	250 M/4	54	55	1480	89	380	325	230													
CAMD 1250/B	280 S/4	74	75	1485	90	560	510														
CAMD 1250/A	315 S/4	98	110	1485	92	640	610	560	480	380	270										
CAMD 1400/B	315 MA/4	130	132	1485	94	780	760	730	680	630											
CAMD 1400/A	315 MC/4	170	200	1485	95	900	880	850	810	760	710	630	500	380							
CAMD 1250/A	225 M/6	27	30	980	77	185	120														
CAMD 1400/B	250 M/6	36	37	980	80	280															
CAMD 1400/A	280 M/6	49	55	985	81	340	320	280	240	165											

Margen sobre el caudal ±5%
Margen del nivel sonoro +3...5db

SELECCIÓN RÁPIDA SISTEMA 4

Características en aspiración

Modelo	Frame	kW abs	kW inst.	r.p.m.	dB	V m³/s														
						2,1	2,3	2,7	3	3,3	3,7	4,2	4,7	5,3	6	6,5	7,5	8,5	9,5	10,5
Pt kgf/m² = mmH ₂ O																				
CAMD 900/B	132 MA/6	3,9	4	950	71	119	114	109	100											
CAMD 900/A	132 MB/6	5	5,5	950	72	133	131	128	119	109	95	76	57							
CAMD 1000/B	160 M/6	6,5	7,5	960	73	155	152	150	147	146	138	128								
CAMD 1000/A	160 L/6	8,7	11	960	74	179	179	176	171	162	157	152	138	124	95	71				
CAMD 1120/B	180 L/6	12	15	970	77			204	202	200	198	195	190	176	171					
CAMD 1120/A	200 LA/6	15	18,5	975	78			238	233	228	223	219	214	209	195	181	162	143	95	
CAMD 1250/B	200 LB/6	20	22	975	79					257	252	247	245	242	233	223	200			
CAMD 1250/A	225 M/6	27	30	980	80					304	299	295	290	280	271	261	252	233	219	
CAMD 1400/B	250 M/6	36	37	980	83									328	323	318	314	309	299	285
CAMD 1400/A	280 M/6	49	55	985	84									380	375	371	366	361	352	333

Margen sobre el caudal ±5%
Margen del nivel sonoro +3...5db

Modelo	Frame	kW abs	kW inst.	r.p.m.	dB	V m³/s									
						12	13	15	17	19	21	23	27	30	
Pt kgf/m² = mmH ₂ O															
CAMD 900/A	315 MB/2	150	160	2980	101	1021	903	589							
CAMD 1120/A	250 M/4	54	55	1480	92	361	309	219							
CAMD 1250/B	280 S/4	74	75	1485	93	532	485								
CAMD 1250/A	315 S/4	98	110	1485	95	608	580	532	456	361	257				
CAMD 1400/B	315 MA/4	130	132	1485	97	741	722	694	646	599					
CAMD 1400/A	315 MC/4	170	200	1485	98	855	836	808	770	722	675	599	475	361	
CAMD 1250/A	225 M/6	27	30	980	80	176	114								
CAMD 1400/B	250 M/6	36	37	980	83	266									
CAMD 1400/A	280 M/6	49	55	985	84	323	304	266	228	157					

Margen sobre el caudal ±5%
Margen del nivel sonoro +3...5db

Curvas Características

CAMD 400

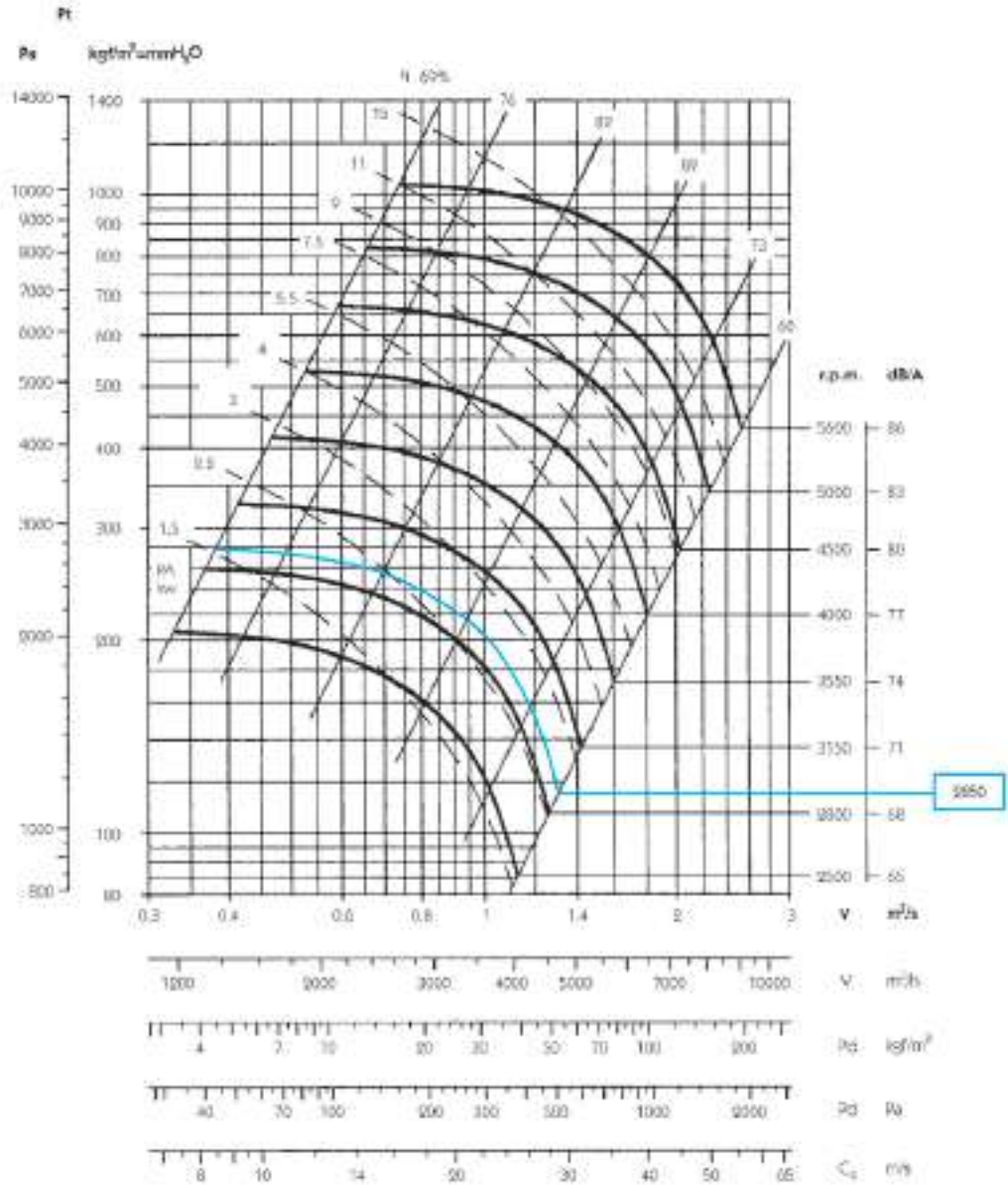

LARGE SERIES

Margen sobre el caudal $\pm 5\%$
 Margen del nivel sonoro $+3...5\text{db}$
 Margen kW absorbidos $\pm 3\%$

Características en impulsión.

Rpm máximas admisibles

Clase 1	
$\leq 100\text{ }^\circ\text{C}$	6000
100... 200 $^\circ\text{C}$	5300
200... 300 $^\circ\text{C}$	4750

Rpm

Características para:
 sistema 4 y 5 en motor
 directo con 2/4/6/8 polos
 según modelo.

Curvas Características

CAMD 500

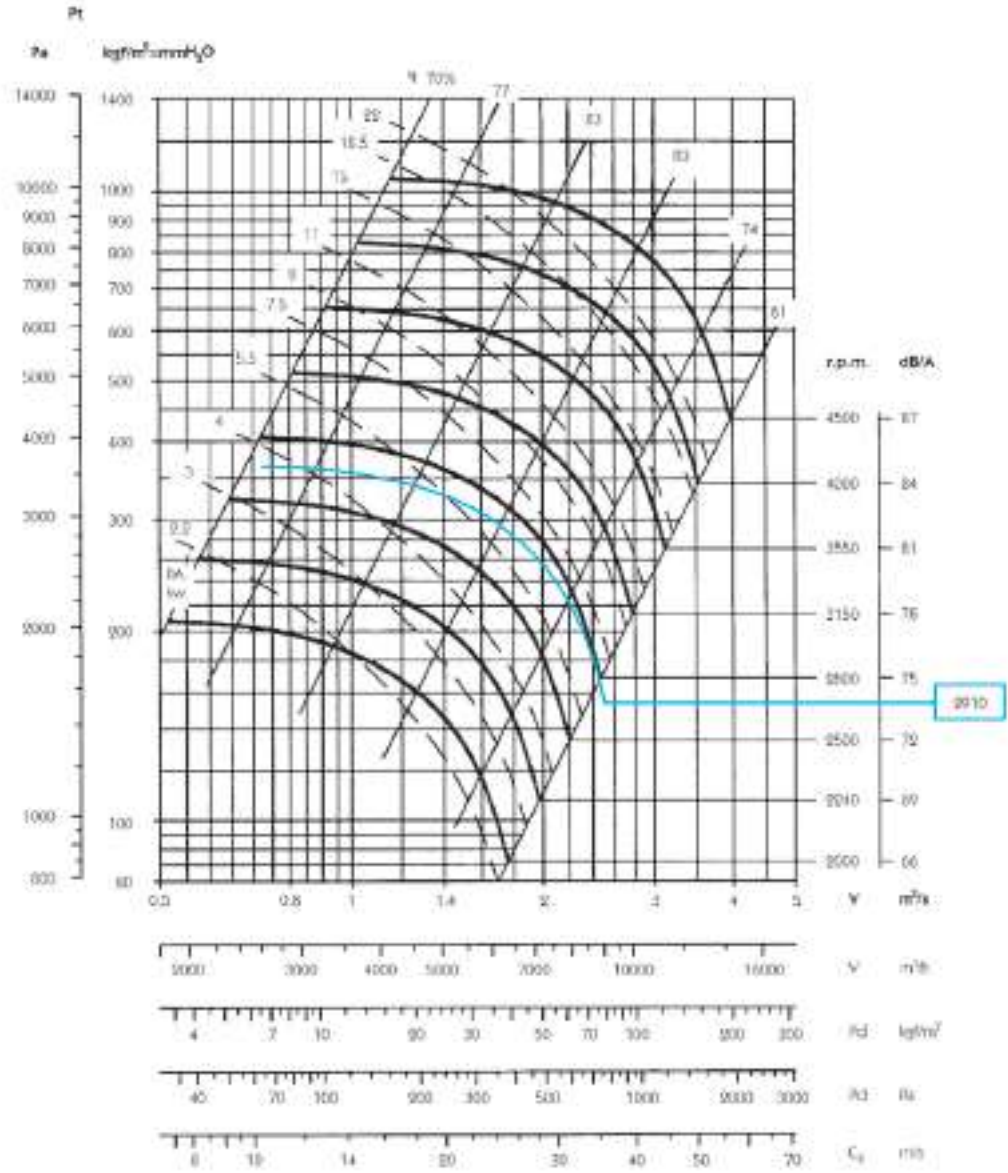

LARGE SERIES

Margen sobre el caudal $\pm 5\%$
 Margen del nivel sonoro $+3...5\text{db}$
 Margen kW absorbidos $\pm 3\%$

Características en impulsión.

Rpm máximas admisibles

Clase 1	
$\leq 100\text{ }^\circ\text{C}$	4750
100... 200 $^\circ\text{C}$	4250
200... 300 $^\circ\text{C}$	3750

Rpm

Características para:
 sistema 4 y 5 en motor
 directo con 2/4/6/8 polos
 según modelo.

Curvas Características

CAMD 560

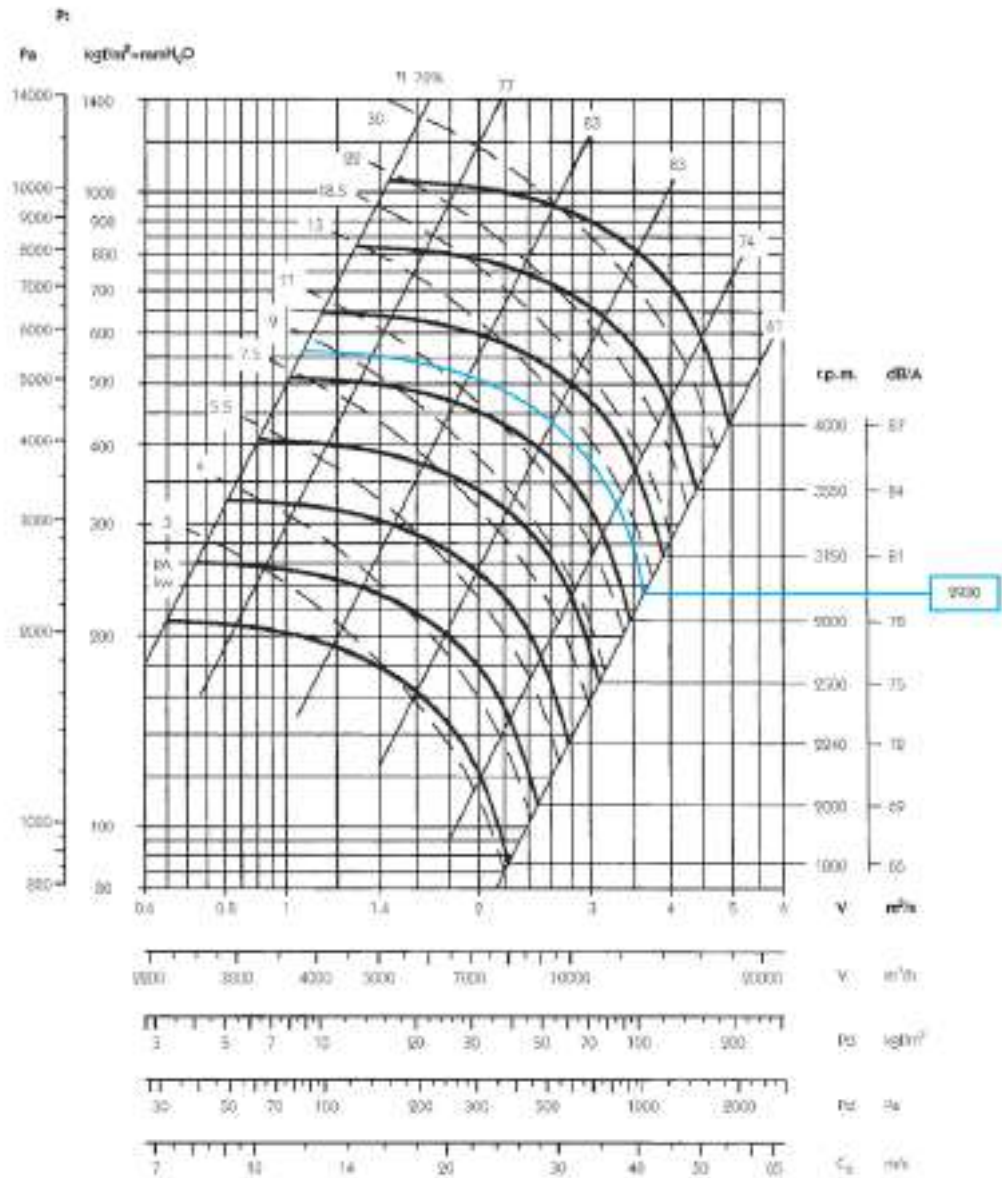

Margen sobre el caudal $\pm 5\%$
 Margen del nivel sonoro $+3...5\text{db}$
 Margen kW absorbidos $\pm 3\%$

Características en impulsión.

Rpm máximas admisibles

Clase 1	
$\leq 100\text{ }^\circ\text{C}$	4250
100... 200 $^\circ\text{C}$	3750
200... 300 $^\circ\text{C}$	3350

Rpm

Características para:
 sistema 4 y 5 en motor
 directo con 2/4/6/8
 según modelo.

Curvas Características

CAMD 630

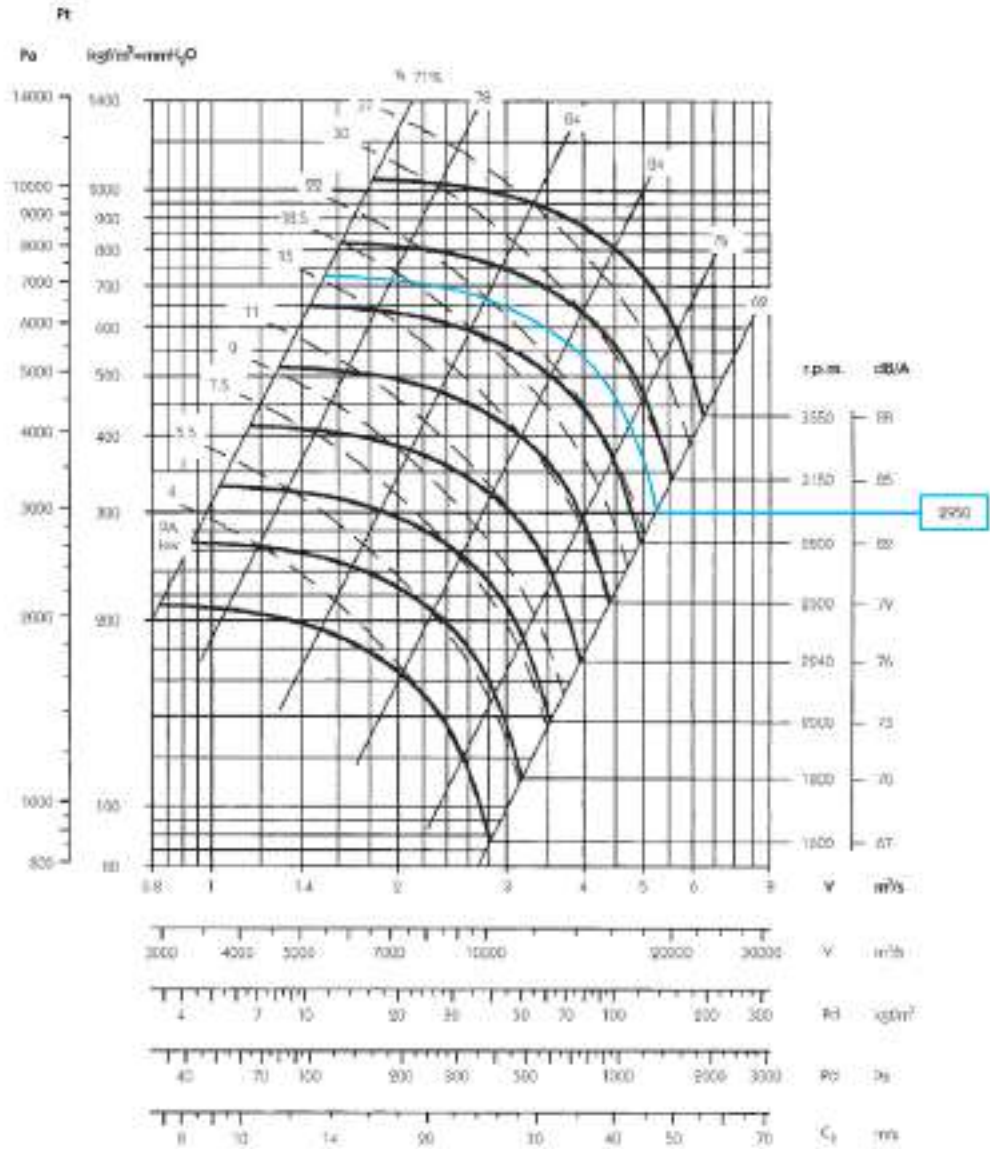

LARGE SERIES

Margen sobre el caudal ± 5 %
 Margen del nivel sonoro +3...5db
 Margen kW absorbidos ± 3%

Características en impulsión.

Rpm máximas admisibles

Clase 1	
≤ 100 °C	3750
100... 200 °C	3350
200... 300 °C	3000

Rpm

Características para:
 sistema 4 y 5 en motor
 directo con 2/4/6/8 polos
 según modelo.

Curvas Características

CAMD 710

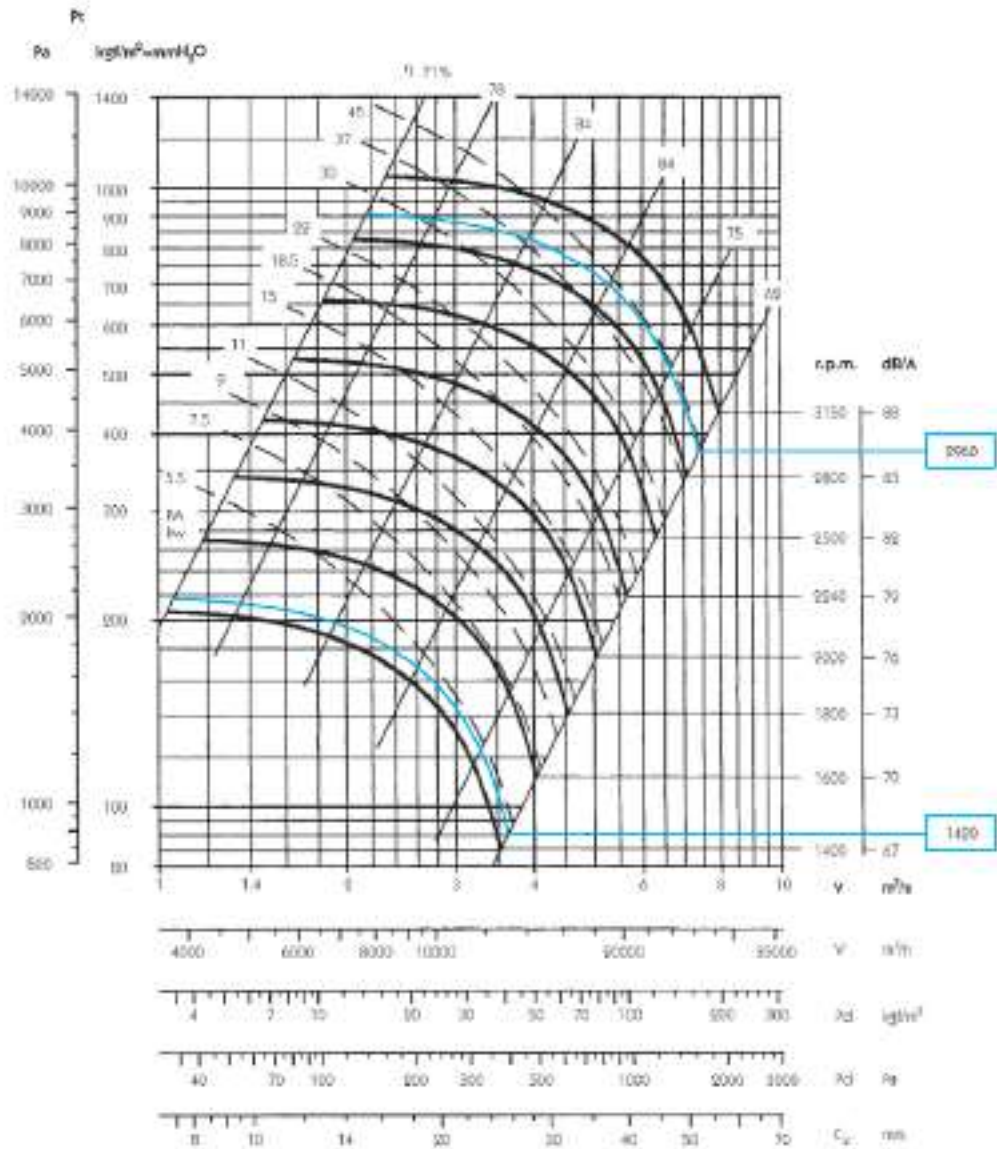

Margen sobre el caudal $\pm 5\%$
 Margen del nivel sonoro $+3...5\text{db}$
 Margen kW absorbidos $\pm 3\%$

Características en impulsión.

Rpm máximas admisibles

Clase 1	
$\leq 100\text{ }^\circ\text{C}$	3350
100... 200 $^\circ\text{C}$	3000
200... 300 $^\circ\text{C}$	2650

Rpm

Características para:
 sistema 4 y 5 en motor
 directo con 2/4/6/8 polos
 según modelo.

Curvas Características

CAMD 800

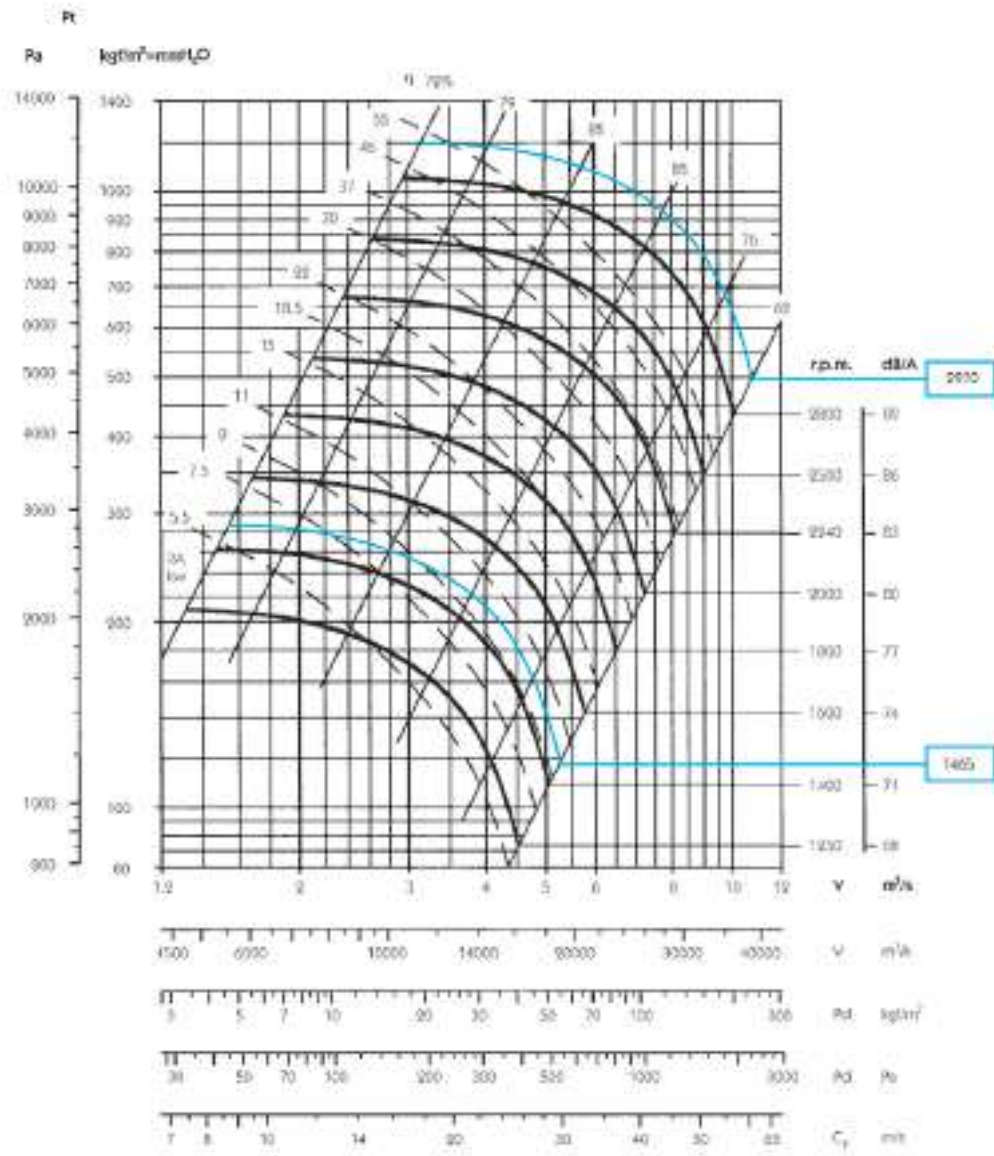

LARGE SERIES

Margen sobre el caudal $\pm 5\%$
 Margen del nivel sonoro $+3...5\text{db}$
 Margen kW absorbidos $\pm 3\%$

Características en impulsión.

Rpm máximas admisibles

Clase 1	
$\leq 100\text{ }^\circ\text{C}$	3000
100... 200 $^\circ\text{C}$	2650
200... 300 $^\circ\text{C}$	2360

Rpm

Características para:
 sistema 4 y 5 en motor
 directo con 2/4/6/8 polos
 según modelo.

Curvas Características

CAMD 900

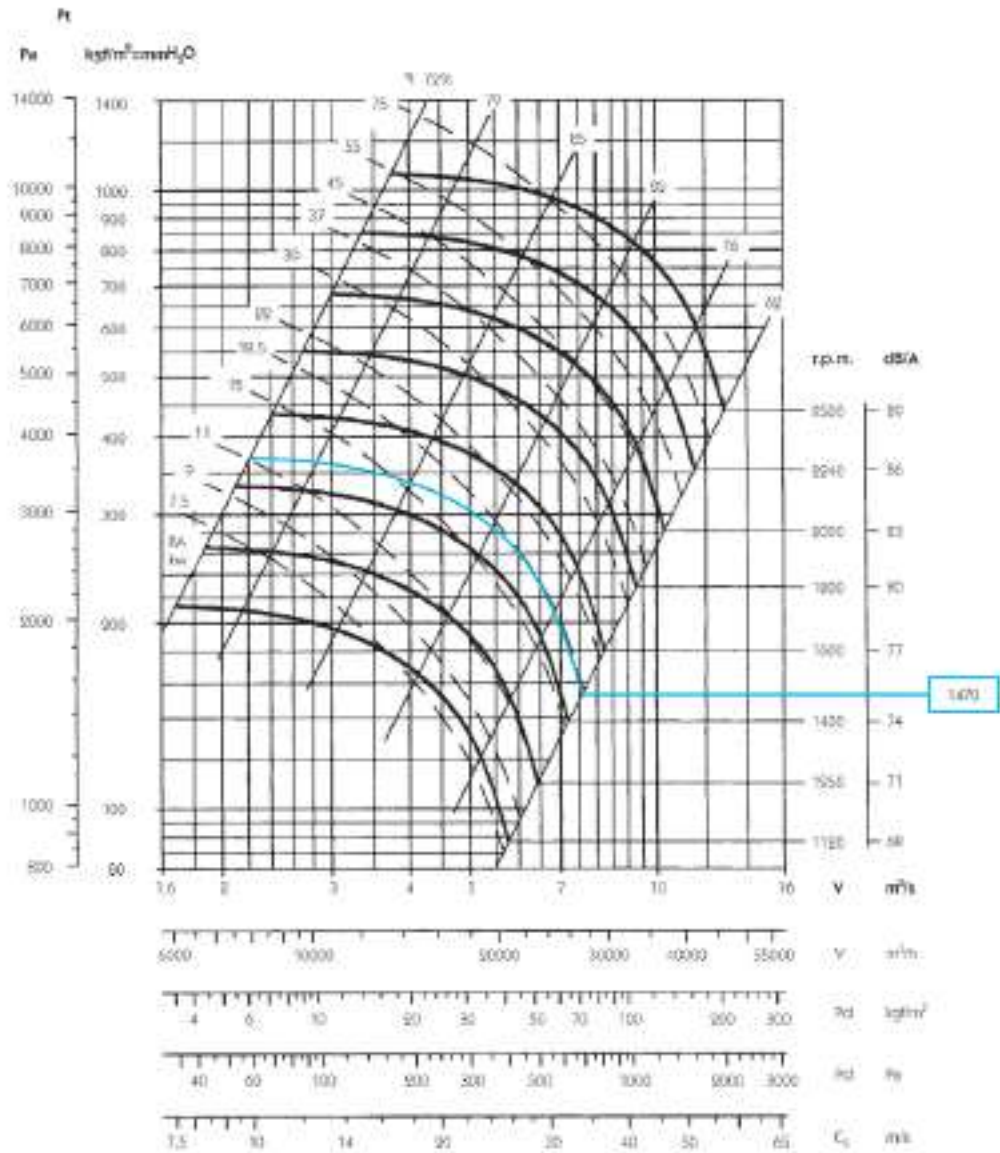

Margen sobre el caudal $\pm 5\%$
 Margen del nivel sonoro $+3...5\text{db}$
 Margen kW absorbidos $\pm 3\%$

Características en impulsión.

Rpm máximas admisibles

Clase 1	
$\leq 100\text{ }^\circ\text{C}$	2650
100... 200 $^\circ\text{C}$	2360
200... 300 $^\circ\text{C}$	2120

Rpm

Características para:
 sistema 4 y 5 en motor
 directo con 2/4/6/8 polos
 según modelo.

Curvas Características

CAMD 1000

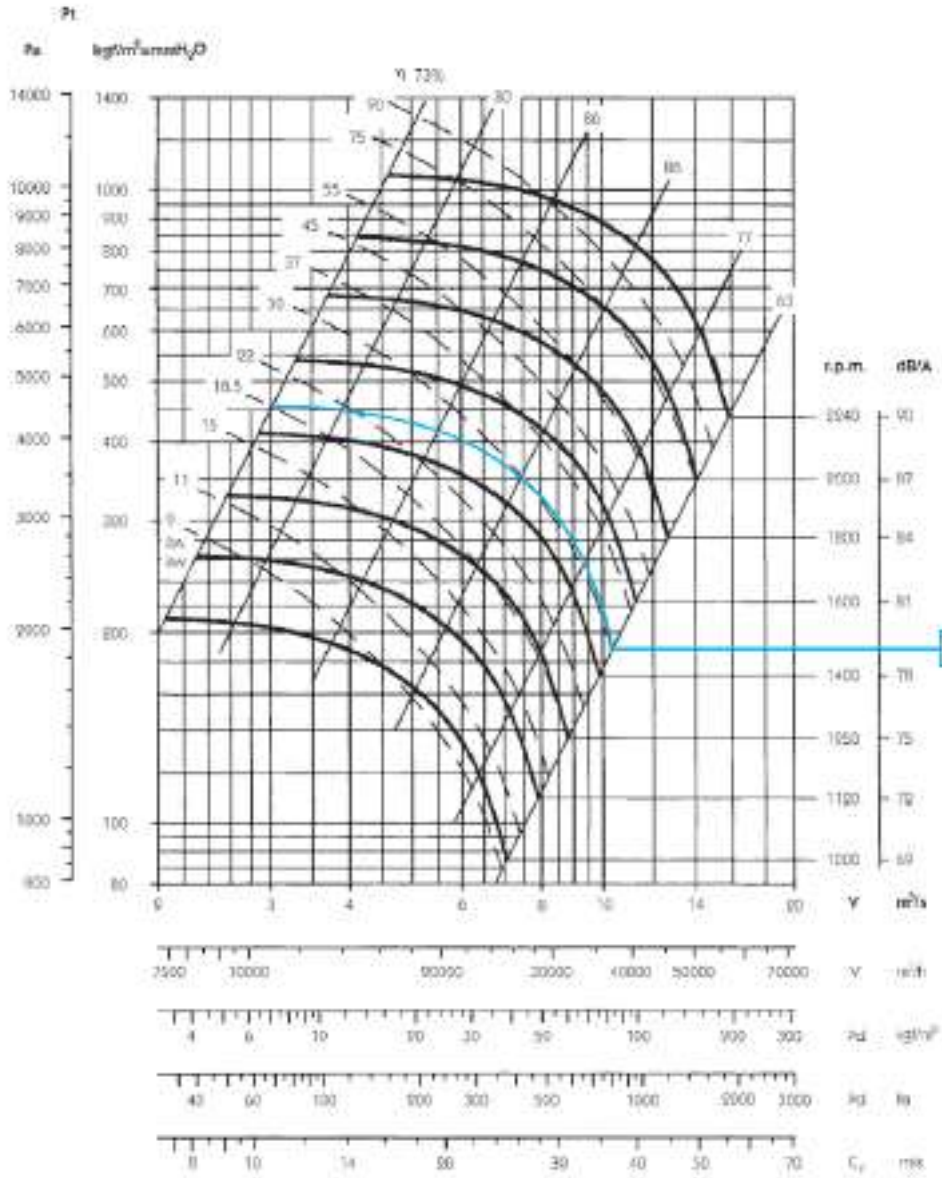

LARGE SERIES

Margen sobre el caudal $\pm 5\%$
 Margen del nivel sonoro $+3...5db$
 Margen kW absorbidos $\pm 3\%$

Características en impulsión.

Rpm máximas admisibles

Clase 1	
$\leq 100\text{ }^{\circ}\text{C}$	2360
100... 200 $^{\circ}\text{C}$	2120
200... 300 $^{\circ}\text{C}$	1900

Rpm

Características para:
 sistema 4 y 5 en motor
 directo con 2/4/6/8 polos
 según modelo.

Curvas Características

CAMD 1120

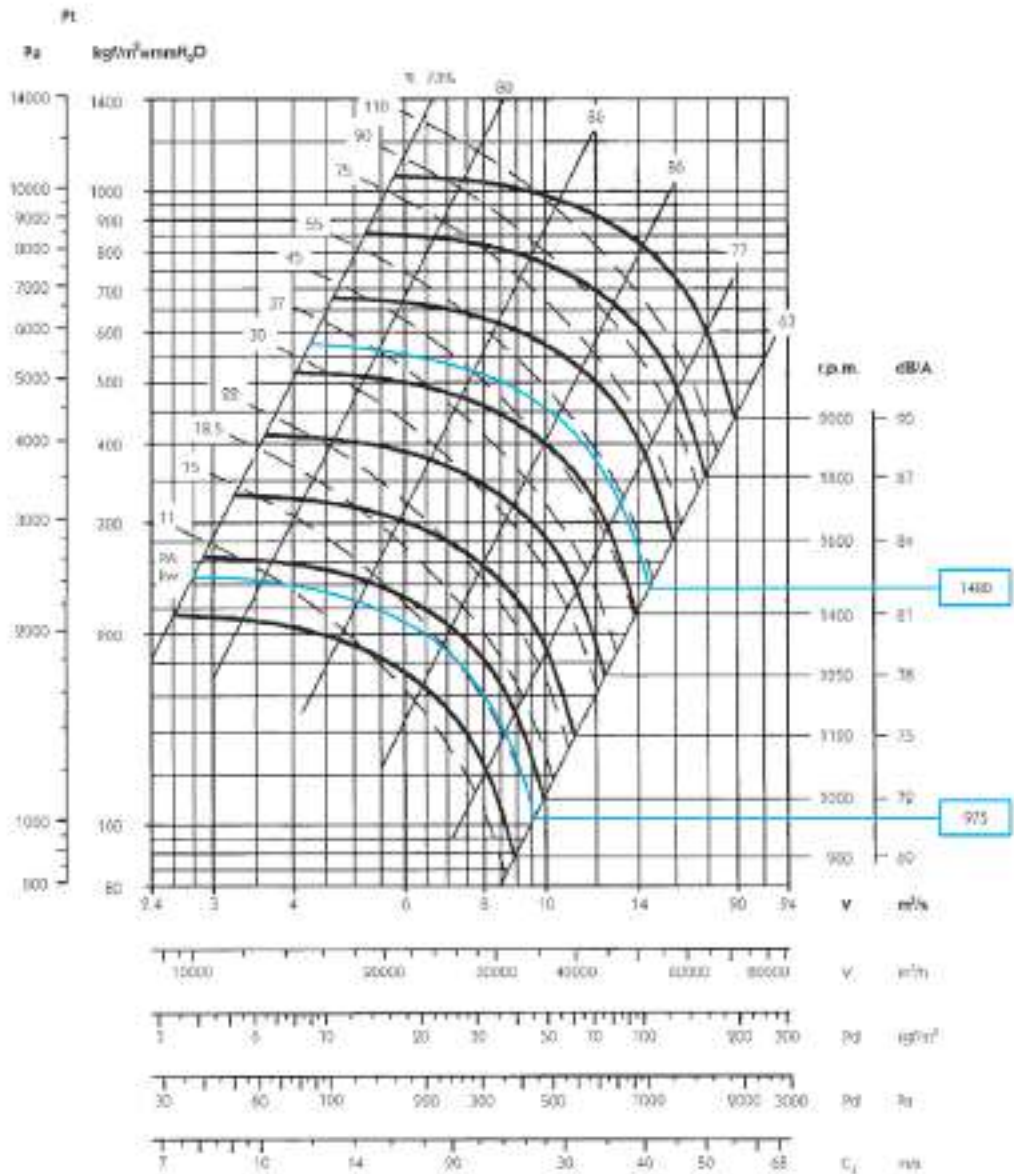

Margen sobre el caudal $\pm 5\%$
 Margen del nivel sonoro $+3...5\text{db}$
 Margen kW absorbidos $\pm 3\%$

Características en impulsión.

Rpm máximas admisibles

Clase 1	
$\leq 100\text{ }^\circ\text{C}$	2120
100... 200 $^\circ\text{C}$	1900
200... 300 $^\circ\text{C}$	1700

Rpm

Características para:
 sistema 4 y 5 en motor
 directo con 2/4/6/8 polos
 según modelo.

Curvas Características

CAMD 1250

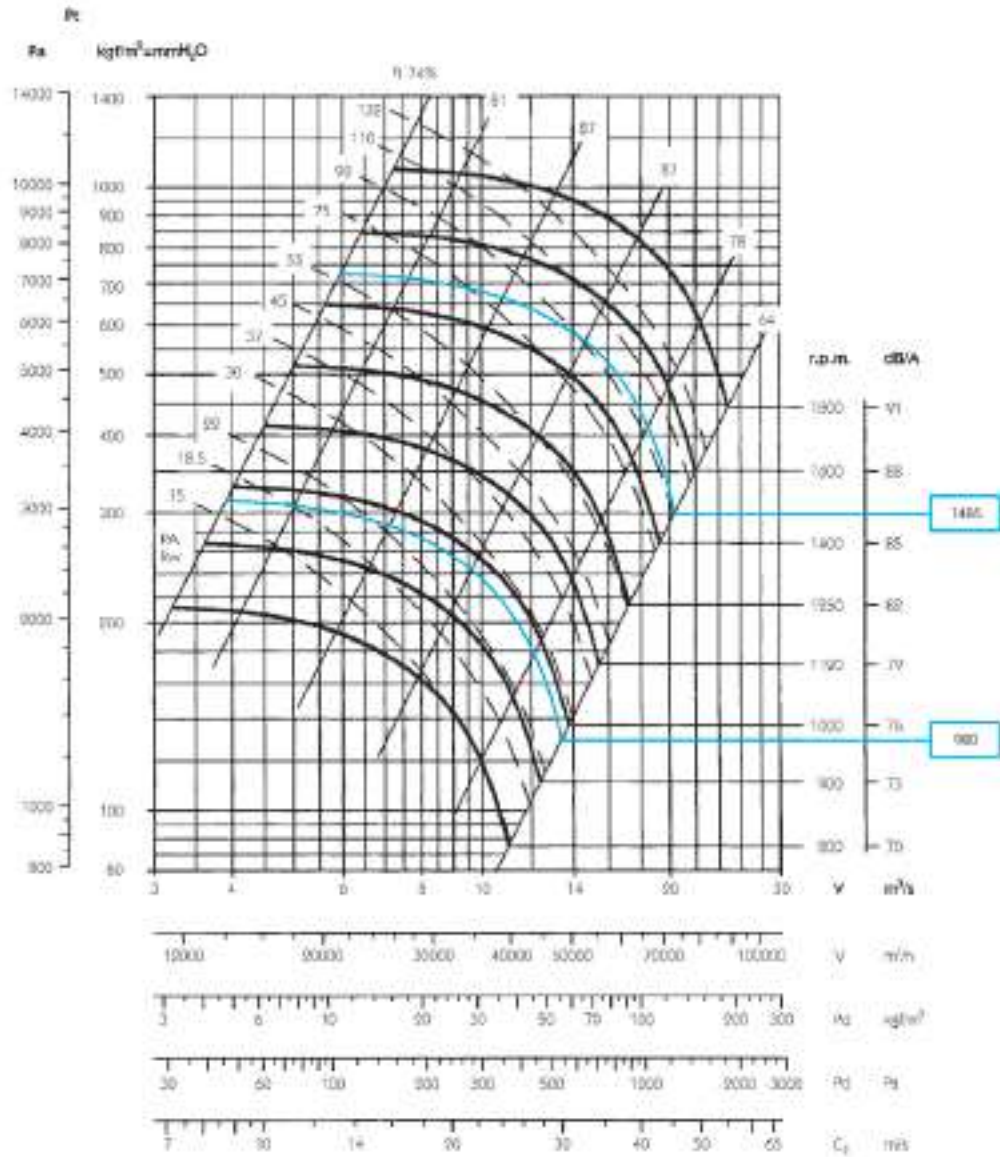

LARGE SERIES

Margen sobre el caudal $\pm 5\%$
 Margen del nivel sonoro $+3...5\text{db}$
 Margen kW absorbidos $\pm 3\%$

Características en impulsión.

Rpm máximas admisibles

Clase 1	
$\leq 100\text{ }^\circ\text{C}$	1900
100... 200 $^\circ\text{C}$	1700
200... 300 $^\circ\text{C}$	1500

Rpm

Características para:
 sistema 4 y 5 en motor
 directo con 2/4/6/8 polos
 según modelo.

Curvas Características

CAMD 1400

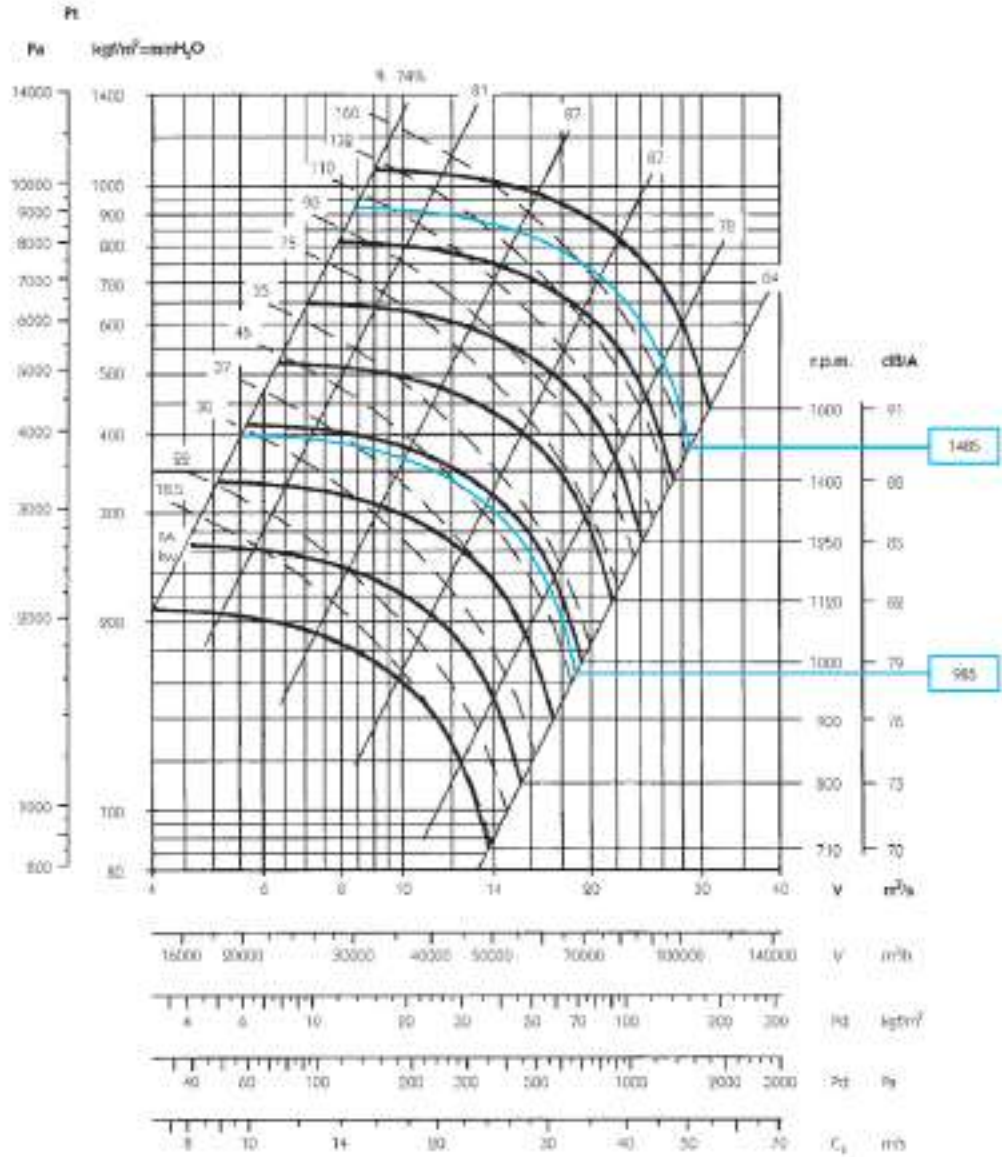

Margen sobre el caudal ± 5 %
 Margen del nivel sonoro +3...5db
 Margen kW absorbidos ± 3%

Características en impulsión.

Rpm máximas admisibles

Clase 1	
≤ 100 °C	1700
100... 200 °C	1500
200... 300 °C	1320

Rpm

Características para:
 sistema 4 y 5 en motor
 directo con 2/4/6/8 polos
 según modelo.

Curvas Características

CAMD 1600

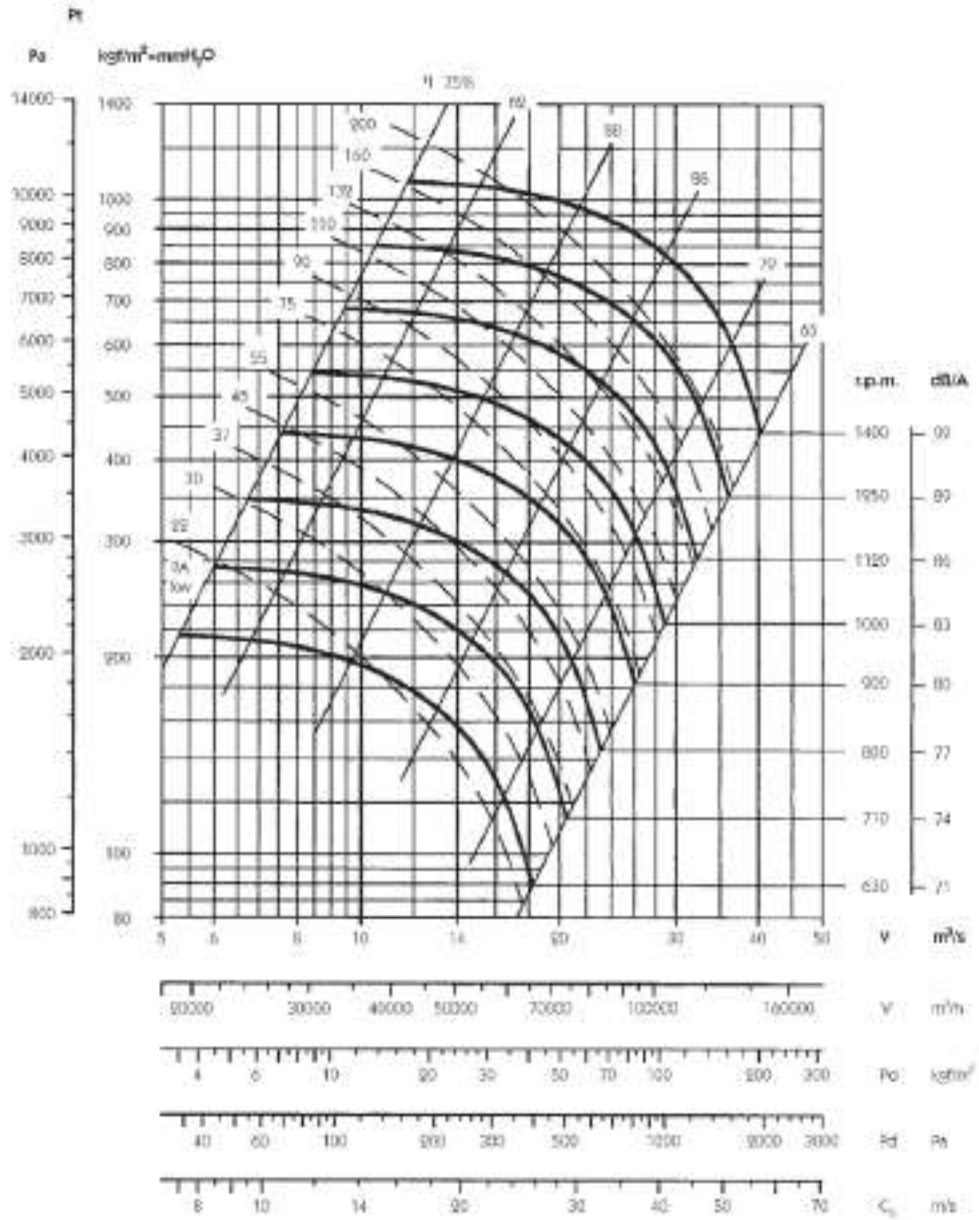

LARGE SERIES

Margen sobre el caudal ± 5 %
 Margen del nivel sonoro +3...5db
 Margen kW absorbidos ± 3%

Características en impulsión.

Rpm máximas admisibles

Clase 1	
≤ 100 °C	1500
100... 200 °C	1320
200... 300 °C	1180

Curvas Características

CAMD 1800

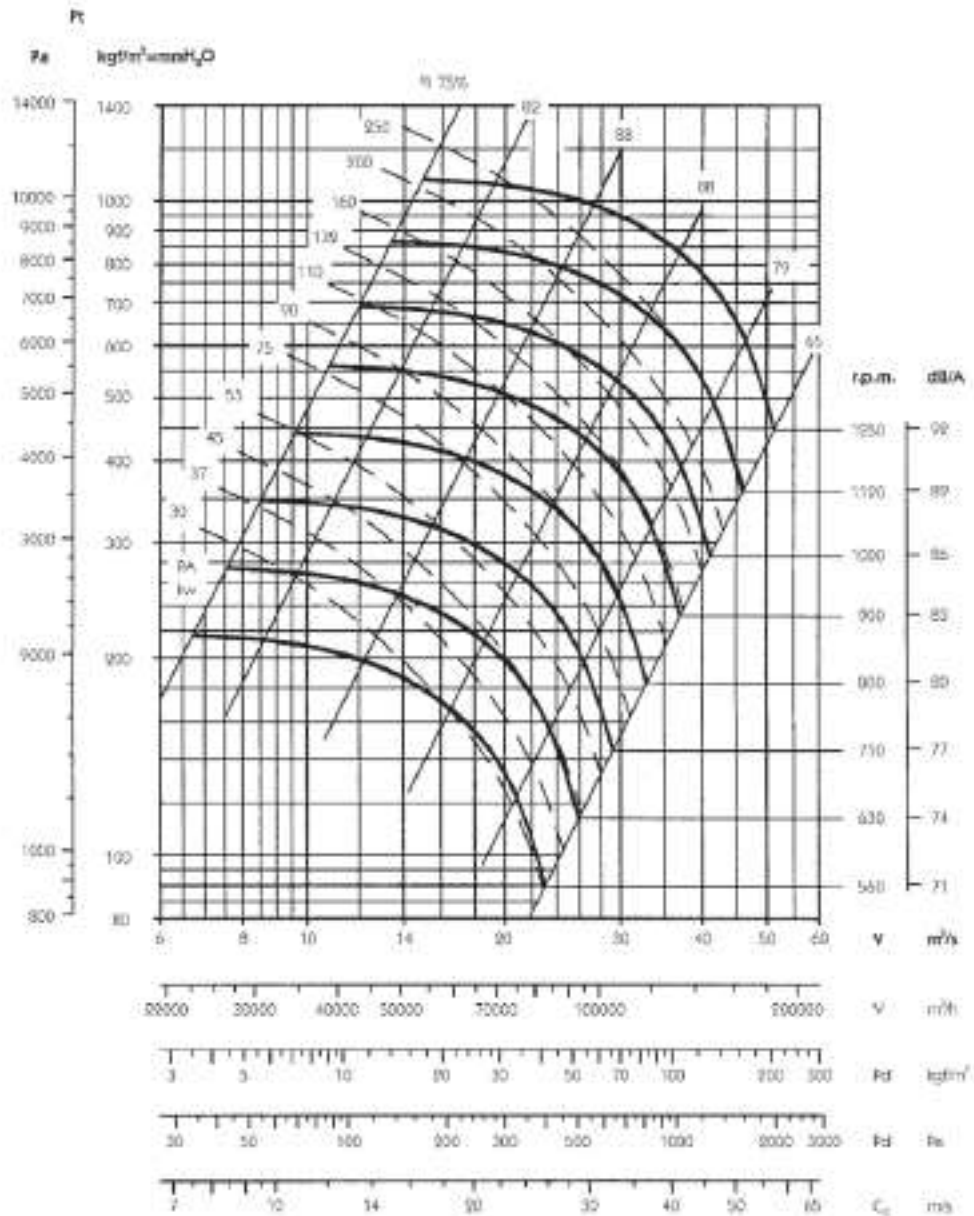

Margen sobre el caudal $\pm 5\%$
 Margen del nivel sonoro $+3...5\text{db}$
 Margen kW absorbidos $\pm 3\%$

Características en impulsión.

Rpm máximas admisibles

Clase 1	
$\leq 100\text{ }^\circ\text{C}$	1320
100... 200 $^\circ\text{C}$	1180
200... 300 $^\circ\text{C}$	1060

Curvas Características

CAMD 2000

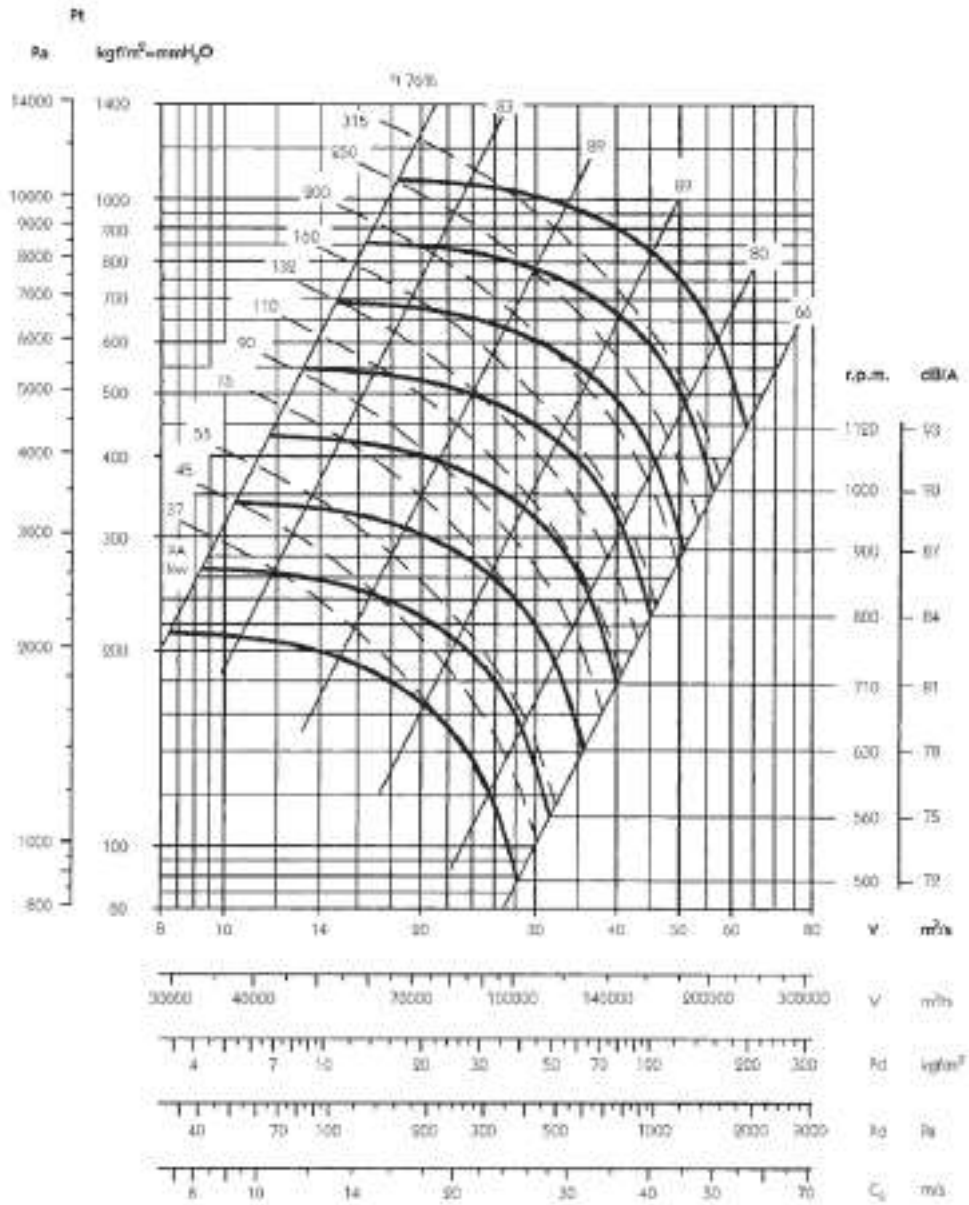

LARGE SERIES

Margen sobre el caudal ± 5 %
 Margen del nivel sonoro +3...5db
 Margen kW absorbidos ± 3%

Características en impulsión.

Rpm máximas admisibles

Clase 1	
≤ 100 °C	1180
100... 200 °C	1060
200... 300 °C	930

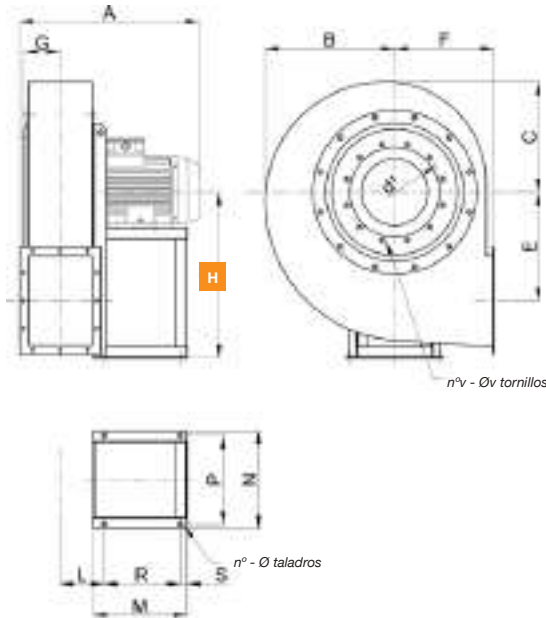
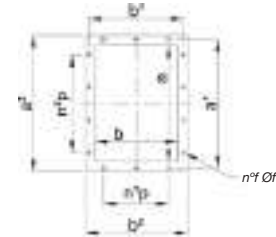
Dimensiones mm
CAMD 400...500

BOCA DE IMPULSIÓN

ORIENTACIONES

H0	H1	H2	H3	H4	H5	H6	H7
RD0	RD45	RD90	RD135	RD180	RD225	RD270	RD315
LG0	LG45	LG90	LG135	LG180	LG225	LG270	LG315

H * La medida de la cota H (distancia entre el suelo y el eje) varía según las orientaciones

MOD.	FRAME	A*	B	C	E	F	G	HO-1-2-3	H4-5	H6-7	L	M*	N	P	R*	S	n°
CAMD 400/B	90 L/2	515	390	330	319	285	103	500	285	500	145	215	269	245	140	25	4
CAMD 400/A	100 LA/2	545	390	330	319	285	103	500	285	500	145	260	312	280	185	25	4
CAMD 450/B	112 M/2	570	415	355	357	320	114	560	320	560	156	260	312	280	185	25	4
CAMD 450/A	132 SA/2	660	415	355	357	320	114	560	320	560	156	320	342	310	245	25	4
CAMD 500/B	132 SB/2	635	470	400	400	360	129	600	360	600	168	320	342	310	245	25	4
CAMD 500/A	160 MA/2	755	470	400	400	360	129	600	360	600	168	425	440	400	345	30	4

MOD.	BOCA IMPULSIÓN														kg	WD ²
	Φ	d ¹	n°v	Φv	a	b	a ¹	b ¹	a ²	b ²	n ¹ p	n ² p	n ^f	Φf		
CAMD 400/B	10	292	8	M8	256	183	292	219	326	253	1-112	2-112	10	12	70	0,6
CAMD 400/A	12	292	8	M8	256	183	292	219	326	253	1-112	2-112	10	12	80	0,7
CAMD 450/B	12	332	8	M8	288	205	332	249	368	285	1-125	2-125	10	12	100	1
CAMD 450/A	12	332	8	M8	288	205	332	249	368	285	1-125	2-125	10	12	115	1,1
CAMD 500/B	12	366	8	M8	322	229	366	273	402	309	1-125	2-125	10	12	140	2
CAMD 500/A	14	366	8	M8	322	229	366	273	402	309	1-125	2-125	10	12	200	2,4

(*) Para construcciones a "ALTA TEMP." cotas "A-M-R" + 50 mm.
 (kg) Peso ventilador con motor.
 WD² = Momento de inercia del rodete, expresado en Kg x m²

Dimensiones mm

SISTEMA
4

CAMD 560...630

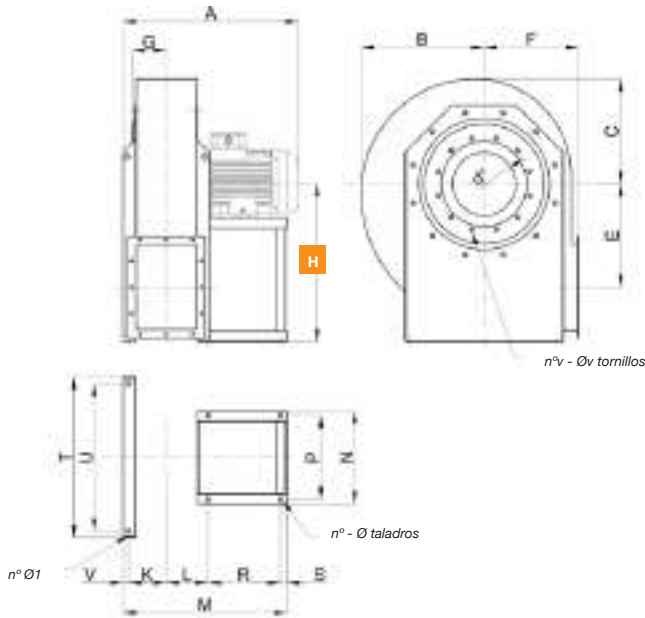

BOCA DE IMPULSIÓN

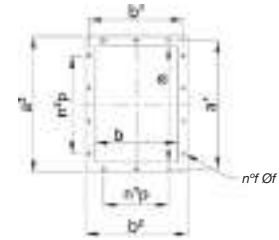

ORIENTACIONES

H0	H1	H2	H3	H4	H5	H6	H7
RD0	RD45	RD90	RD135	RD180	RD225	RD270	RD315
LG0	LG45	LG90	LG135	LG180	LG225	LG270	LG315

H * La medida de la cota H (distancia entre el suelo y el eje) varía según las orientaciones

MOD.	FRAME	A*	B	C	E	F	G	HO-1-2-3	H4-5	H6-7	L	K	M*	N	P	R*	S	T
CAMD 560/B	160 CAMA/2	805	525	445	436	400	144	670	400	670	181	165	744	440	400	345	30	690
CAMD 560/A	160 CASB/2	805	525	445	436	400	144	670	400	670	181	165	744	440	400	345	30	690
CAMD 560/B	90 L/4	615	525	445	436	400	144	670	400	670	181	165	534	269	245	140	25	690
CAMD 560/A	100 LA/4	645	525	445	436	400	144	670	400	670	181	165	579	312	280	185	25	690
CAMD 630/B	160 L/2	915	590	505	490	450	158	750	450	750	197	179	775	440	400	345	30	760
CAMD 630/A	200 LA/2	1015	590	505	490	450	158	750	450	750	227	179	890	558	515	420	40	760
CAMD 630/B	100 LB/4	675	590	505	490	450	158	750	450	750	197	179	610	312	280	185	25	760
CAMD 630/A	112 M/4	675	590	505	490	450	158	750	450	750	197	179	610	312	280	185	25	760

BOCA IMPULSIÓN

MOD.	U	V	n°	Φ	Φ'	d'	n°v	Φv	a	b	a'	b'	a²	b²	n°p	n°p'	n°f	Φf	kg	WD²
CAMD 560/B	630	23	4+2	14	17	405	8	M8	361	256	405	300	441	336	1-125	2-125	10	12	220	3
CAMD 560/A	630	23	4+2	14	17	405	8	M8	361	256	405	300	441	336	1-125	2-125	10	12	235	3,4
CAMD 560/B	630	23	4+2	10	17	405	8	M8	361	256	405	300	441	336	1-125	2-125	10	12	130	3
CAMD 560/A	630	23	4+2	12	17	405	8	M8	361	256	405	300	441	336	1-125	2-125	10	12	140	3,4
CAMD 630/B	700	23	4+2	14	17	448	12	M8	404	288	448	332	484	368	2-125	3-125	14	12	300	4,4
CAMD 630/A	700	23	4+2	19	17	448	12	M8	404	288	448	332	484	368	2-125	3-125	14	12	350	5,8
CAMD 630/B	700	23	4+2	12	17	448	12	M8	404	288	448	332	484	368	2-125	3-125	14	12	140	4,4
CAMD 630/A	700	23	4+2	12	17	448	12	M8	404	288	448	332	484	368	2-125	3-125	14	12	150	5,8

(*) Para construcciones a "ALTA TEMP." cotas "A-M-R" + 50 mm.
(kg) Peso ventilador con motor.
WD² = Momento de inercia del rodete, expresado en Kg x m²

LARGE SERIES

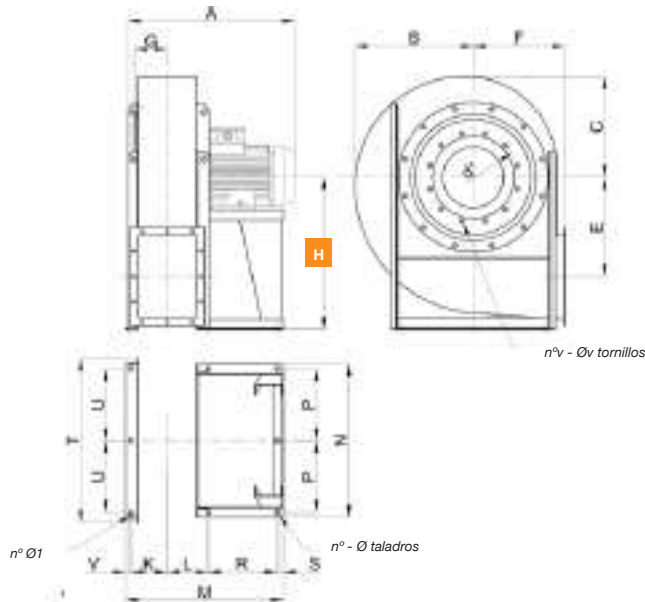
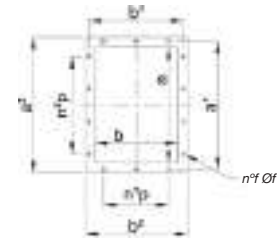
Dimensiones mm
CAMD 710...1400

BOCA DE IMPULSIÓN

ORIENTACIONES

H0	H1	H2	H3	H4	H5	H6	H7
RD0	RD45	RD90	RD135	RD180	RD225	RD270	RD315
LG0	LG45	LG90	LG135	LG180	LG225	LG270	LG315

H * La medida de la cota H (distancia entre el suelo y el eje) varía según las orientaciones

MOD.	FRAME	A*	B	C	E	F	G	HO-1-2-3	H4-5	H6-7	L	K	M*	N	P	R*	S	T
CAMD 710/B	200 LB/2	1055	670	570	558	500	179	670	500	850	210	202	931	831	385	450	40	920
CAMD 710/A	225 M/2	1105	670	570	558	500	179	670	500	850	210	202	941	831	385	460	40	920
CAMD 710/B	112 M/4	715	670	570	558	500	179	670	500	850	210	202	951	831	385	170	40	920
CAMD 710/A	132 S/4	805	670	570	558	500	179	670	500	850	210	202	711	831	385	230	40	920
CAMD 800/B	280 S/2	1345	745	635	625	560	199	750	560	950	230	221	1170	921	430	650	40	1000
CAMD 800/A	280 M/2	1345	745	635	625	560	199	750	560	950	230	221	1170	921	430	650	40	1000
CAMD 800/B	132 MA/4	870	745	635	625	560	199	750	560	950	230	221	750	921	430	230	40	1000
CAMD 800/A	160 M/4	915	745	635	625	560	199	750	560	950	230	221	855	921	430	335	40	1000
CAMD 900/B	315 MA/2	1510	835	710	703	630	221	850	630	1060	251	246	1273	1021	480	710	40	1100
CAMD 900/A	315 MB/2	1510	835	710	703	630	221	850	630	1060	251	246	1273	1021	480	710	40	1100
CAMD 900/B	160 L/4	1040	835	710	703	630	221	850	630	1060	251	246	898	1021	480	335	40	1100
CAMD 900/A	180 L/4	1080	835	710	703	630	221	850	630	1060	251	246	943	1021	480	380	40	1100
CAMD 900/B	132 MA/6	915	835	710	703	630	221	850	630	1060	251	246	793	1021	480	230	40	1100
CAMD 900/A	132 MB/6	915	835	710	703	630	221	850	630	1060	251	246	793	1021	480	230	40	1100
CAMD 1000/B	200 L/4	1195	930	795	791	710	242	950	710	1180	276	265	1072	1120	530	440	50	1230
CAMD 1000/A	225 S/4	1245	930	795	791	710	242	950	710	1180	276	265	1082	1120	530	450	50	1230
CAMD 1000/B	160 M/6	1015	930	795	791	710	242	950	710	1180	276	265	957	1120	530	325	50	1230
CAMD 1000/A	160 L/6	1095	930	795	791	710	242	950	710	1180	276	265	957	1120	530	325	50	1230
CAMD 1120/B	225 M/4	1320	1045	895	891	800	272	1060	800	1320	333	299	1156	1260	590	420	50	1370
CAMD 1120/A	250 M/4	1395	1045	895	891	800	272	1060	800	1320	333	299	1226	1260	590	490	50	1370
CAMD 1120/B	180 L/6	1210	1045	895	891	800	272	1060	800	1320	333	299	1076	1260	590	340	50	1370
CAMD 1120/A	200 LA/6	1270	1045	895	891	800	272	1060	800	1320	333	299	1146	1260	590	410	50	1370
CAMD 1250/B	280 S/4	1585	1175	1005	1003	900	287	1180	900	1500	364	330	1408	1390	655	610	50	1540
CAMD 1250/A	315 S/4	1605	1175	1005	1003	900	287	1180	900	1500	364	330	1468	1390	655	670	50	1540
CAMD 1250/B	200 LB/4	1335	1175	1005	1003	900	287	1180	900	1500	364	330	1208	1390	655	410	50	1540
CAMD 1250/A	225 M/6	1385	1175	1005	1003	900	287	1180	900	1500	364	330	1218	1390	655	420	50	1540
CAMD 1400/B	315 MA/4	1770	1305	1115	1116	1000	322	1320	1000	1700	418	365	1537	1530	725	640	60	1690
CAMD 1400/A	315 MC/4	1770	1305	1115	1116	1000	322	1320	1000	1700	418	365	1537	1530	725	640	60	1690
CAMD 1400/B	250 M/6	1525	1305	1115	1116	1000	322	1320	1000	1700	418	365	1357	1530	725	460	60	1690
CAMD 1400/A	280 M/6	1650	1305	1115	1116	1000	322	1320	1000	1700	418	365	1477	1530	725	580	60	1690

(*) Para construcciones a "ALTA TEMP." cotas "A-M-R" + 50 mm.
 (kg) Peso ventilador con motor.
 WD² = Momento de inercia del rodete, expresado en Kg x m²

LARGE SERIES

Dimensiones mm

SISTEMA
4

CAMD 710...1400

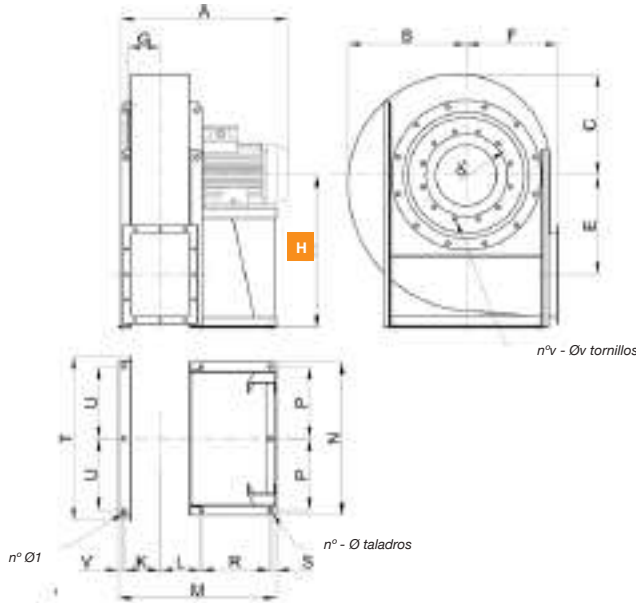

BOCA DE IMPULSIÓN

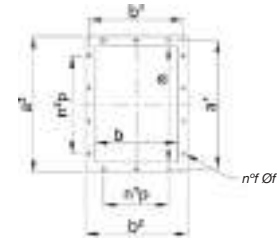

ORIENTACIONES

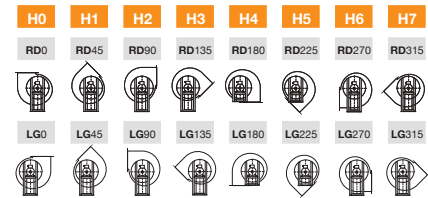

H * La medida de la cota H (distancia entre el suelo y el eje) varía según las orientaciones

BOCA IMPULSIÓN

MOD.	U	V	n°	Φ	Φ'	d'	n°v	Φv	a	b	a'	b'	a ²	b ²	n°p	n°p	n°f	Φf	kg	WD ²
CAMD 710/B	385	29	5+3	19	19	497	12	M8	453	322	497	366	533	402	2-125	3-125	14	12	440	8
CAMD 710/A	385	29	5+3	19	19	497	12	M8	453	322	497	366	533	402	2-125	3-125	14	12	480	9,8
CAMD 710/B	385	29	5+3	19	19	497	12	M8	453	322	497	366	533	402	2-125	3-125	14	12	250	9,8
CAMD 710/A	385	29	5+3	19	19	497	12	M8	453	322	497	366	533	402	2-125	3-125	14	12	260	9,8
CAMD 800/B	430	29	5+3	19	19	551	12	M8	507	361	551	405	587	441	2-125	3-125	14	12	600	15
CAMD 800/A	430	29	5+3	19	19	551	12	M8	507	361	551	405	587	441	2-125	3-125	14	12	690	17,3
CAMD 800/B	430	29	5+3	19	19	551	12	M8	507	361	551	405	587	441	2-125	3-125	14	12	335	15
CAMD 800/A	430	29	5+3	19	19	551	12	M8	507	361	551	405	587	441	2-125	3-125	14	12	390	17,3
CAMD 900/B	480	26	5+3	19	19	629	12	M8	569	404	629	464	669	504	2-160	3-160	14	14	940	24
CAMD 900/A	480	26	5+3	19	19	629	12	M8	569	404	629	464	669	504	2-160	3-160	14	14	960	27,5
CAMD 900/B	480	26	5+3	19	19	629	12	M8	569	404	629	464	669	504	2-160	3-160	14	14	480	24
CAMD 900/A	480	26	5+3	19	19	629	12	M8	569	404	629	464	669	504	2-160	3-160	14	14	530	27,5
CAMD 900/B	480	26	5+3	19	19	629	12	M8	569	404	629	464	669	504	2-160	3-160	14	14	390	24
CAMD 900/A	480	26	5+3	19	19	629	12	M8	569	404	629	464	669	504	2-160	3-160	14	14	400	27,5
CAMD 1000/B	530	41	5+3	19	19	698	12	M8	638	453	698	513	738	553	2-160	3-160	14	14	660	40
CAMD 1000/A	530	41	5+3	19	19	698	12	M8	638	453	698	513	738	553	2-160	3-160	14	14	700	50
CAMD 1000/B	530	41	5+3	19	19	698	12	M8	638	453	698	513	738	553	2-160	3-160	14	14	560	40
CAMD 1000/A	530	41	5+3	19	19	698	12	M8	638	453	698	513	738	553	2-160	3-160	14	14	590	50
CAMD 1120/B	590	54	5+3	24	24	775	16	M10	715	507	775	567	815	607	2-160	4-160	16	14	980	70
CAMD 1120/A	590	54	5+3	24	24	775	16	M10	715	507	775	567	815	607	2-160	4-160	16	14	1050	88
CAMD 1120/B	590	54	5+3	24	24	775	16	M10	715	507	775	567	815	607	2-160	4-160	16	14	820	70
CAMD 1120/A	590	54	5+3	24	24	775	16	M10	715	507	775	567	815	607	2-160	4-160	16	14	900	88
CAMD 1250/B	655	54	5+3	24	24	861	16	M10	801	569	871	639	921	889	2-200	3-200	14	14	1350	120
CAMD 1250/A	655	54	5+3	24	24	861	16	M10	801	569	871	639	921	889	2-200	3-200	14	14	1400	148
CAMD 1250/B	655	54	5+3	24	24	861	16	M10	801	569	871	639	921	889	2-200	3-200	14	14	1100	120
CAMD 1250/A	655	54	5+3	24	24	861	16	M10	801	569	871	639	921	889	2-200	3-200	14	14	1180	148
CAMD 1400/B	725	54	5+3	24	24	958	16	M10	898	638	968	708	1018	758	3-200	4-200	18	14	1930	200
CAMD 1400/A	725	54	5+3	24	24	958	16	M10	898	638	968	708	1018	758	3-200	4-200	18	14	2010	250
CAMD 1400/B	725	54	5+3	24	24	958	16	M10	898	638	968	708	1018	758	3-200	4-200	18	14	1620	200
CAMD 1400/A	725	54	5+3	24	24	958	16	M10	898	638	968	708	1018	758	3-200	4-200	18	14	1740	250

(*) Para construcciones a "ALTA TEMP" cotas "A-M-R" + 50 mm.
(kg) Peso ventilador con motor.
WD² = Momento de inercia del rodete, expresado en Kg x m²

LARGE SERIES

Dimensiones mm

CAMD-X 400...500

SISTEMA 1

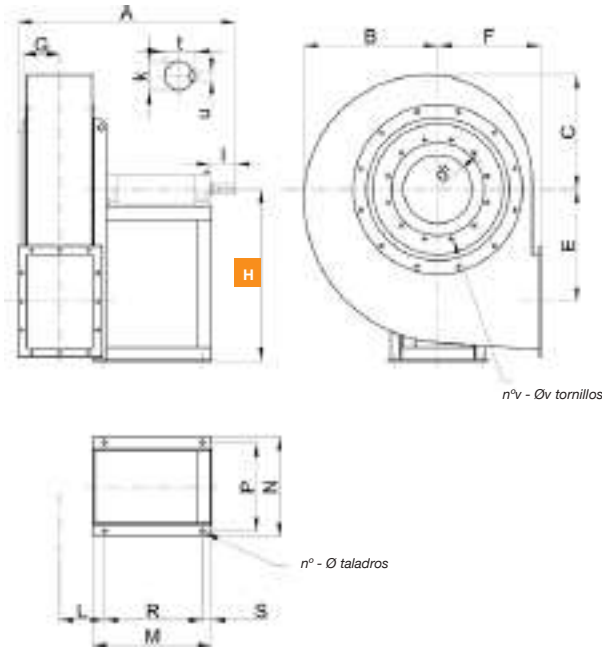

SISTEMA 12

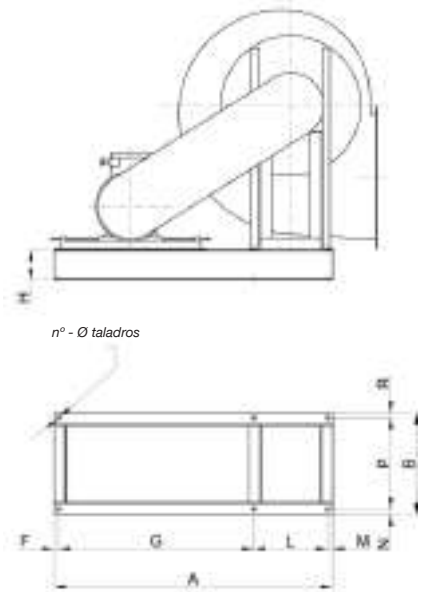

MOD.	A*	B	C	E	F	G	H0	H1	H2	H3	H4	H5
CAMD 400	880	390	330	319	285	103	500	500	500	500	285	285
CAMD 450	905	415	355	357	320	114	560	560	560	560	320	320
CAMD 500	940	490	410	400	360	129	600	600	600	600	360	360

MOD.	A	B*	H	F	G	L	M	N	P*
CAMD 400	1020	530	120	20	650	330	20	25	480
CAMD 450	1175	530	120	25	800	330	20	25	480
CAMD 500	1265	495	160	25	830	385	25	30	430

MOD.	H6	H7	L	M*	N	P	R*	S	n°	Φ	k	l
CAMD 400	500	500	145	560	370	330	480	30	4	14	38k6	80
CAMD 450	560	560	156	560	370	330	480	30	4	14	38k6	80
CAMD 500	600	600	168	520	438	385	430	40	4	17	42k6	110

MOD.	R	N°	Φ	kg
CAMD 400	25	6	14	50
CAMD 450	25	6	14	55
CAMD 500	35	6	17	76

MOD.	t	u	d ¹	n°v	Φv	kg	WD ²
CAMD 400	41	10	292	8	M8	80	0,7
CAMD 450	41	10	232	8	M8	90	1,1
CAMD 500	45	12	366	8	M8	130	2,4

(*) Para construcciones a "ALTA TEMP." en mod. de 400 a 500, cotas "B-P" + 50 mm.
Kg = Peso de la base soporte

(*) Para construcciones a "ALTA TEMP." en mod. de 400 a 500, cotas "A-M-R" + 50 mm.
(kg) Peso ventilador sin motor.
WD² = Momento de inercia del rodete, expresado en Kg x m²

BOCA DE IMPULSIÓN

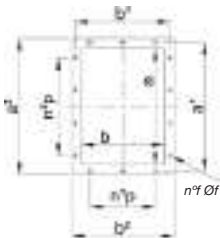

BOCA IMPULSIÓN

MOD.	a	b	a'	b'	a''	b''	n°p	n°p	n°f	Φf
CAMD 400	256	183	292	219	326	253	1-112	2-112	10	12
CAMD 450	288	205	332	249	368	285	1-125	2-125	10	12
CAMD 500	322	229	366	273	402	309	1-125	2-125	10	12

ORIENTACIONES

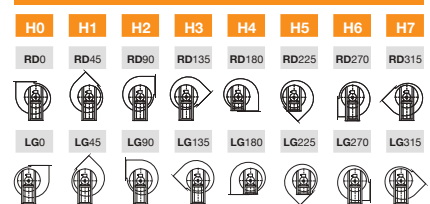

H * La medida de la cota H (distancia entre el suelo y el eje) varía según las orientaciones

Dimensiones mm

CAMD-X 560...630

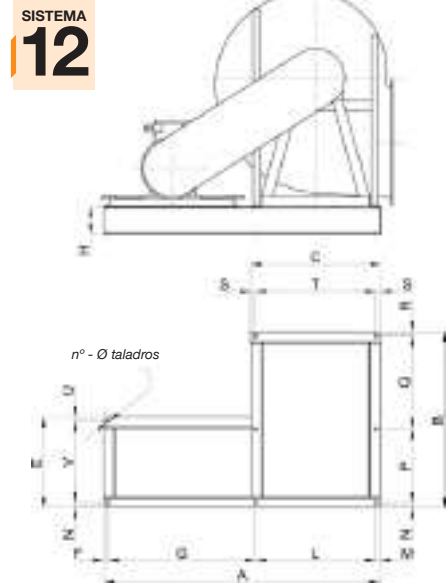
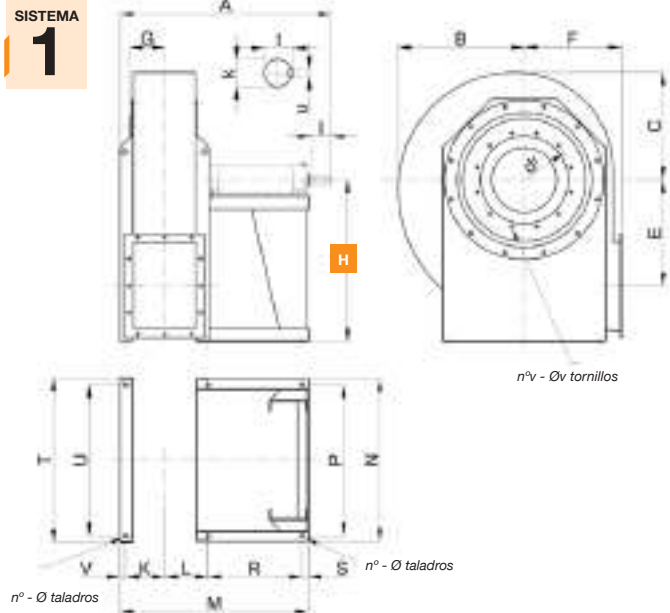

MOD.	A*	B	C	E	F	G	H0	H1	H2	H3	H4	H5
CAMD 560	990	525	445	436	400	144	670	670	670	670	400	400
CAMD 630	1020	590	505	490	450	158	750	750	750	750	450	450

MOD.	A	B*	C	E	H	F	G	L	M	N	P*
CAMD 560	1415	829	690	510	160	25	735	630	25	30	430
CAMD 630	1610	859	760	530	160	25	860	700	25	30	430

MOD.	H6	H7	L	K	M*	N	P	R*	S	T	U	V
CAMD 560	670	670	181	165	839	683	630	430	40	690	630	23
CAMD 630	750	750	197	179	869	753	700	430	40	760	700	23

MOD.	Q	R	S	T	U	V	N°	Φ	kg
CAMD 560	346	23	30	630	25	455	8	17	102
CAMD 630	376	23	30	700	25	475	8	17	112

MOD.	n°	Φ	k	l	t	u	d ¹	n°v	Φv	kg	WD ²
CAMD 560	4+2	17	48k6	110	51,5	14	405	8	M8	170	3,4
CAMD 630	4+2	17	48k6	110	51,5	14	448	12	M8	200	5,8

(*) Para construcciones a "ALTA TEMP." en mod. de 560 a 630, cotas "B-P" + 50 mm.
Kg = Peso de la base soporte

(*) Para construcciones a "ALTA TEMP." en mod. de 560 a 630, cotas "A-M-R" + 50 mm.
(kg) Peso ventilador sin motor.
WD² = Momento de inercia del rodete, expresado en Kg x m²

LARGE SERIES

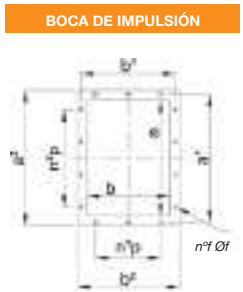

MOD.	a	b	a ¹	b ¹	a ²	b ²	n°p	n°p	n°f	Φf
CAMD 560	361	256	405	300	441	336	1-125	2-125	10	12
CAMD 630	404	288	448	332	484	368	2-125	3-125	14	12



H * La medida de la cota H (distancia entre el suelo y el eje) varía según las orientaciones

Dimensiones mm

CAMD-X 710...2000

SISTEMA 1

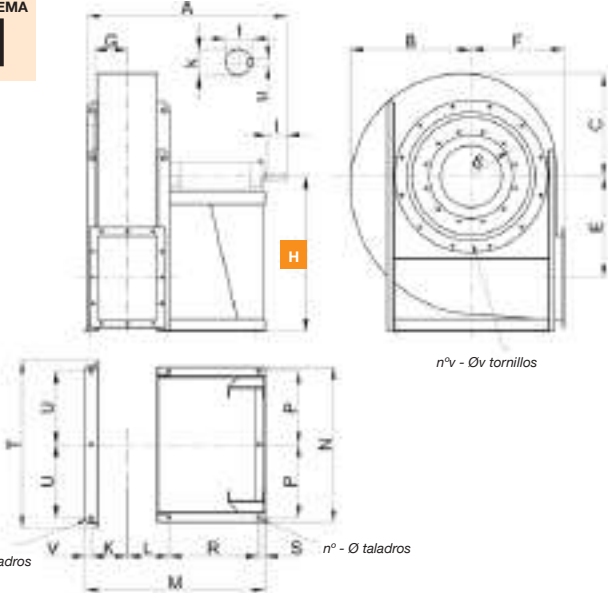

n° - Ø taladros

n°v - Øv tornillos

n° - Ø taladros

SISTEMA 12

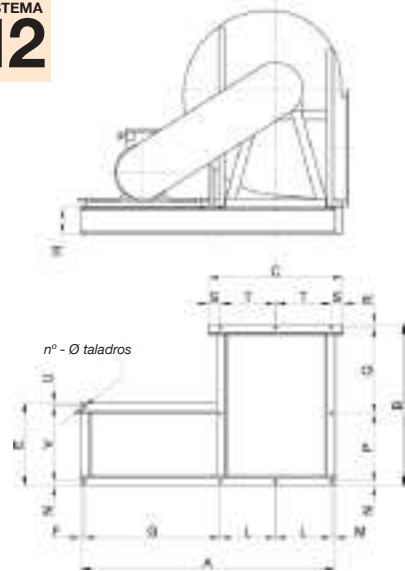

n° - Ø taladros

MOD.	A*	B	C	E	F	G	H0	H1	H2	H3	H4	H5
CAMD 710	1150	670	570	558	500	179	670	670	670	670	500	500
CAMD 800	1240	745	635	625	560	199	750	750	750	750	560	560
CAMD 900	1290	835	710	703	630	221	850	850	850	850	630	630
CAMD 1000	1430	930	795	791	710	242	950	950	950	950	710	710
CAMD 1120	1690	1045	895	891	800	272	1060	1060	1060	1060	800	800
CAMD 1250	1750	1175	1005	1003	900	287	1180	1180	1180	1180	900	900
CAMD 1400	1900	1305	1115	1116	1000	322	1320	1320	1320	1320	1000	1000
CAMD 1600	2165	1535	1245	1250	1120	360	1500	1500	1250	1250	1120	1120
CAMD 1800	2320	1705	1390	1395	1250	404	1650	1550	1400	1320	1250	1250
CAMD 2000	2420	1920	1555	1563	1400	453	1850	1700	1600	1450	1400	1400

MOD.	H6	H7	L	K	M*	N	P	R*	S	T	U	V
CAMD 710	850	850	210	202	996	831	385	515	40	920	385	29
CAMD 800	950	950	230	221	1085	921	430	565	40	1000	430	29
CAMD 900	1060	1060	251	246	1128	1021	480	565	40	1100	480	26
CAMD 1000	1180	1180	276	265	1237	1120	530	605	50	1230	530	41
CAMD 1120	1320	1320	333	299	1496	1260	590	760	50	1370	590	54
CAMD 1250	1500	1500	364	330	1558	1390	655	760	50	1540	655	54
CAMD 1400	1700	1500	418	365	1677	1530	725	780	60	1690	725	54
CAMD 1600	1900	1600	477	413	1934	1720	820	920	60	1950	820	64
CAMD 1800	2120	1800	524	466	2020	1910	915	920	60	2150	915	54
CAMD 2000	2360	2000	568	515	2147	2110	1015	920	60	2390	1015	84

MOD.	n°	Φ	k	l	t	u	d ¹	n°v	Φv	kg	WD ²
CAMD 710	5+3	19	48k6	110	51,5	14	497	12	M8	270	9,8
CAMD 800	5+3	19	55m6	110	59	16	551	12	M8	330	17,3
CAMD 900	5+3	19	55m6	110	59	16	629	12	M8	380	27,5
CAMD 1000	5+3	19	65m6	140	69	18	698	12	M8	500	50
CAMD 1120	5+3	24	75m6	140	79,5	20	775	16	M10	770	88
CAMD 1250	5+3	24	75m6	140	79,5	20	861	16	M10	1000	148
CAMD 1400	5+3	24	80m6	170	85	22	958	16	M10	1380	250
CAMD 1600	5+3	28	90m6	170	95	25	1067	24	M10	1820	410
CAMD 1800	5+3	28	100j6	210	106	28	1200	24	M10	2600	725
CAMD 2000	5+3	28	100j6	210	106	28	1337	24	M10	3150	1110

(*) Para construcciones a "ALTA TEMP." en mod. de 710 a 900, cotas "A-M-R" + 50 mm.
 (kg) Peso ventilador sin motor.
 WD² = Momento de inercia del rodete, expresado en Kg x m²

MOD.	A	B*	C	E	H	F	G	L	M	N	P*
CAMD 710	1980	987	920	690	180	30	1150	385	30	30	515
CAMD 800	2070	1074	1000	690	180	30	1150	430	30	30	565
CAMD 900	2200	1121	1100	750	180	30	1180	480	30	30	565
CAMD 1000	2300	1213	1230	755	180	30	1180	530	30	35	605
CAMD 1120	2470	1461	1370	830	180	35	1220	590	35	35	760
CAMD 1250	2600	1521	1540	830	180	35	1220	655	35	35	760
CAMD 1400	3150	1631	1690	990	180	35	1630	725	35	35	780
CAMD 1600	3340	1880	1950	990	180	35	1630	820	35	35	920
CAMD 1800	3600	1979	2150	1100	180	35	1700	915	35	35	920
CAMD 2000	3800	2077	2390	1100	180	35	1700	1015	35	35	920

MOD.	Q	R	S	T	U	V	N°	Φ	kg
CAMD 710	412	30	75	385	30	630	10	19	165
CAMD 800	451	28	70	430	30	630	10	19	170
CAMD 900	497	29	70	480	30	690	10	19	182
CAMD 1000	541	32	85	530	30	690	10	19	255
CAMD 1120	632	34	95	590	35	760	10	24	285
CAMD 1250	694	32	115	655	35	760	10	24	300
CAMD 1400	783	33	120	725	35	920	10	24	350
CAMD 1600	890	35	155	820	35	920	10	28	380
CAMD 1800	986	38	160	915	35	1030	10	28	460
CAMD 2000	1083	39	180	1015	35	1030	10	28	485

(*) Para construcciones a "ALTA TEMP." en mod. de 710 a 900, cotas "B-P" + 50 mm.
 Kg = Peso de la base soporte

BOCA DE IMPULSIÓN

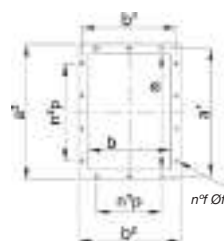

ORIENTACIONES

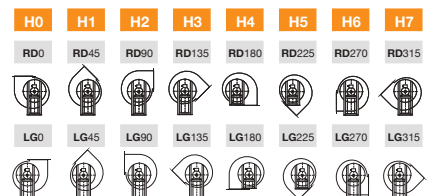

H * La medida de la cota H (distancia entre el suelo y el eje) varía según las orientaciones

BOCA IMPULSIÓN

MOD.	a	b	a'	b'	a ²	b ²	n°p	n°p	n°f	Φf
CAMD 710	453	322	497	366	533	402	2-125	3-125	14	12
CAMD 800	507	361	551	405	587	441	2-125	3-125	14	12
CAMD 900	569	404	629	464	669	504	2-160	3-160	14	14
CAMD 1000	638	453	698	513	738	553	2-160	3-160	14	14
CAMD 1120	715	507	775	567	815	607	2-160	4-160	16	14

BOCA IMPULSIÓN

MOD.	a	b	a'	b'	a ²	b ²	n°p	n°p	n°f	Φf
CAMD 1250	801	569	871	639	921	689	2-200	3-200	14	14
CAMD 1400	898	638	968	708	1018	758	2-200	4-200	18	14
CAMD 1600	1007	715	1077	785	1127	835	3-200	4-200	18	14
CAMD 1800	1130	801	1210	881	1270	941	3-200	5-200	20	18
CAMD 2000	1267	898	1347	978	1407	1038	4-200	6-200	24	18

LARGE SERIES

Accesorios

Contrabrida aspiración

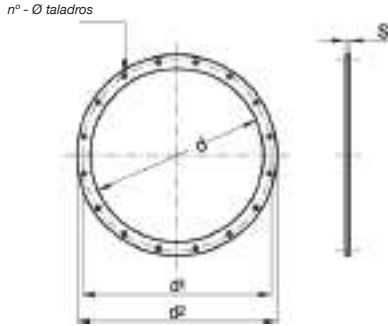

MOD.	d	d ¹	d ²	n°	Φ	s	kg
CAMD 400	255	292	325	8	11	4	1
CAMD 450	286	332	366	8	11	5	1,6
CAMD 500	321	366	401	8	11	5	1,8
CAMD 560	361	405	441	8	11	5	2
CAMD 630	406	448	486	12	11	5	2,2
CAMD 710	456	497	536	12	11	5	2,5
CAMD 800	506	551	586	12	11	5	2,7
CAMD 900	568	629	668	12	11	6	4,6
CAMD 1000	638	698	738	12	11	6	5
CAMD 1120	718	775	818	16	13	6	5,5
CAMD 1250	808	861	908	16	13	6	6,2
CAMD 1400	908	958	1008	16	13	6	7
CAMD 1600	1008	1067	1108	24	13	6	7,8
CAMD 1800	1130	1200	1250	24	13	8	13,8
CAMD 2000	1260	1337	1380	24	13	8	15,5

Contrabrida impulsión

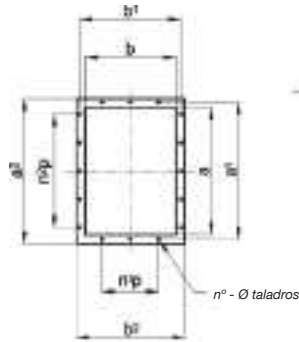

MOD.	a	b	a ¹	b ¹	a ²	b ²	n ¹ p	n ² p	n°	Φ	s	kg
CAMD 400	256	183	292	219	326	253	1-112	2-112	10	12	4	1,1
CAMD 450	288	205	332	249	368	285	1-125	2-125	10	12	5	1,8
CAMD 500	322	229	366	273	402	309	1-125	2-125	10	12	5	2
CAMD 560	361	256	405	300	441	336	1-125	2-125	10	12	5	2,2
CAMD 630	404	288	448	332	484	368	2-125	3-125	14	12	5	2,4
CAMD 710	453	322	497	366	533	402	2-125	3-125	14	12	5	2,7
CAMD 800	507	361	551	405	587	441	2-125	3-125	14	12	5	3
CAMD 900	569	404	629	464	669	504	2-160	3-160	14	14	6	5
CAMD 1000	638	453	698	513	738	553	2-160	3-160	14	14	6	5,6
CAMD 1120	715	507	775	567	815	607	2-160	4-160	16	14	6	6,2
CAMD 1250	801	569	871	639	921	689	2-200	3-200	14	14	8	11,2
CAMD 1400	898	638	968	708	1018	758	3-200	4-200	18	14	8	12,5
CAMD 1600	1007	715	1077	785	1127	835	3-200	4-200	18	14	8	14
CAMD 1800	1130	801	1210	881	1270	941	3-200	5-200	20	18	8	18
CAMD 2000	1267	898	1347	978	1407	1038	4-200	6-200	24	18	8	20

Red protección en aspiración

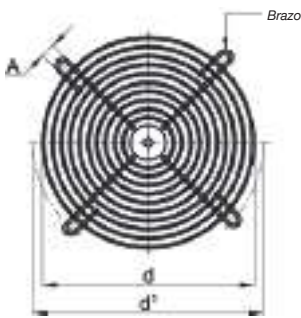

MOD.	d	d ¹	A	n°	kg
CAMD 400	255	292	11	4	0,3
CAMD 450	286	332	11	4	0,35
CAMD 500	321	366	11	4	0,4
CAMD 560	361	405	11	8	0,7
CAMD 630	406	448	11	8	0,8
CAMD 710	456	497	11	8	0,9
CAMD 800	506	551	11	8	1
CAMD 900	568	629	11	8	1,2
CAMD 1000	638	698	11	8	1,5
CAMD 1120	718	775	13	8	2
CAMD 1250	808	861	13	8	2,5
CAMD 1400	908	958	13	8	3
CAMD 1600	1008	1067	13	8	3,5
CAMD 1800	1130	1200	13	8	8,5
CAMD 2000	1260	1337	13	8	10

Junta anti vibratoria en impulsión

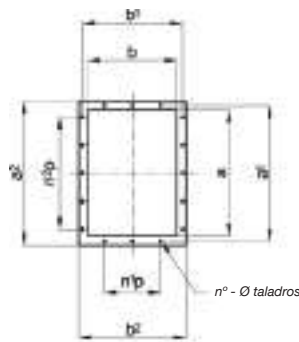

MOD.	a	b	a ¹	b ¹	a ²	b ²	n ¹ p	n ² p	n°	Φ	H	kg
CAMD 400	256	183	292	219	326	253	1-112	2-112	10	12	200	2,4
CAMD 450	288	205	332	249	368	285	1-125	2-125	10	12	200	3,8
CAMD 500	322	229	366	273	402	309	1-125	2-125	10	12	200	4,2
CAMD 560	361	256	405	300	441	336	1-125	2-125	10	12	200	4,6
CAMD 630	404	288	448	332	484	368	2-125	3-125	14	12	200	5
CAMD 710	453	322	497	366	533	402	2-125	3-125	14	12	200	5,6
CAMD 800	507	361	551	405	587	441	2-125	3-125	14	12	200	6,2
CAMD 900	569	404	629	464	669	504	2-160	3-160	14	14	200	10,2
CAMD 1000	638	453	698	513	738	553	2-160	3-160	14	14	200	11,4
CAMD 1120	715	507	775	567	815	607	2-160	4-160	16	14	200	12,6
CAMD 1250	801	569	871	639	921	689	2-200	3-200	14	14	200	23
CAMD 1400	898	638	968	708	1018	758	3-200	4-200	18	14	200	25,5
CAMD 1600	1007	715	1077	785	1127	835	3-200	4-200	18	14	200	28,5
CAMD 1800	1130	801	1210	881	1270	941	3-200	5-200	20	18	200	37
CAMD 2000	1267	898	1347	978	1407	1038	4-200	6-200	24	18	200	41

LARGE SERIES

Accesorios

Junta anti vibratoria en aspiración

n° - Ø taladros

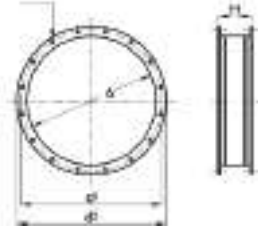

MOD.	d	d ¹	d ²	n°	Φ	H	kg
CAMD 400	255	292	325	8	11	200	2,2
CAMD 450	286	332	366	8	11	200	3,4
CAMD 500	321	366	401	8	11	200	3,8
CAMD 560	361	405	441	8	11	200	4,2
CAMD 630	406	448	486	12	11	200	4,6
CAMD 710	456	497	536	12	11	200	5,1
CAMD 800	506	551	586	12	11	200	5,6
CAMD 900	568	629	668	12	11	200	9,4
CAMD 1000	638	698	738	12	11	200	10,4
CAMD 1120	718	775	818	16	13	200	11,6
CAMD 1250	808	861	908	16	13	200	13
CAMD 1400	908	958	1008	16	13	200	14,4
CAMD 1600	1008	1067	1108	24	13	200	16
CAMD 1800	1130	1200	1250	24	13	200	29
CAMD 2000	1260	1337	1380	24	13	200	33

Regulador de caudal en aspiración

n° - Ø taladros

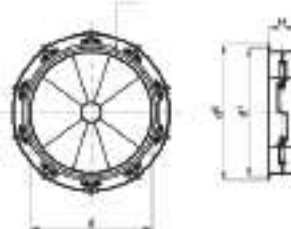

MOD.	d	d ¹	d ²	n°	Φ	H	kg
CAMD 500	321	366	401	8	11	200	24
CAMD 560	361	405	441	8	11	250	26
CAMD 630	406	448	486	12	11	250	30
CAMD 710	456	497	536	12	11	250	32
CAMD 800	506	551	586	12	11	250	45
CAMD 900	568	629	668	12	11	250	50
CAMD 1000	638	698	738	12	11	300	58
CAMD 1120	718	775	818	16	13	300	68
CAMD 1250	808	861	908	16	13	350	87
CAMD 1400	908	958	1008	16	13	350	102
CAMD 1600	1008	1067	1108	24	13	350	120
CAMD 1800	1130	1200	1250	24	13	400	150
CAMD 2000	1260	1337	1380	24	13	400	170

Dámper de aletas contrapuestas

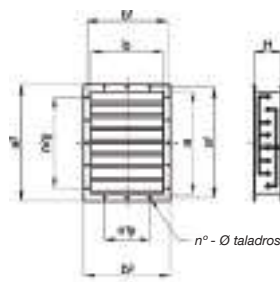

MOD.	a	b	a ¹	b ¹	a ²	b ²	n'p	n°p	n°	Φ	H (1)	H (2)	kg (1)	kg (2)
CAMD 500	322	229	366	273	402	309	1-125	2-125	10	12	220	250	11	12
CAMD 560	361	256	405	300	441	336	1-125	2-125	10	12	220	250	14	15
CAMD 630	404	288	448	332	484	368	2-125	3-125	14	12	220	250	18	19
CAMD 710	453	322	497	366	533	402	2-125	3-125	14	12	220	250	21	22
CAMD 800	507	361	551	405	587	441	2-125	3-125	14	12	220	250	24	25
CAMD 900	569	404	629	464	669	504	2-160	3-160	14	14	220	250	28	29
CAMD 1000	638	453	698	513	738	553	2-160	3-160	14	14	220	250	32	33
CAMD 1120	715	507	775	567	815	607	2-160	4-160	16	14	220	250	36	38
CAMD 1250	801	569	871	639	921	689	2-200	3-200	14	14	220	250	44	46
CAMD 1400	898	638	968	708	1018	758	3-200	4-200	18	14	220	250	50	52
CAMD 1600	1007	715	1077	785	1127	835	3-200	4-200	18	14	220	250	55	58
CAMD 1800	1130	801	1210	881	1270	941	3-200	5-200	20	18	220	250	81	84
CAMD 2000	1267	898	1347	978	1407	1038	4-200	6-200	24	18	220	250	92	96

(1) Hasta 300 mm H₂O
(2) A partir de 300 mm H₂O

Amortiguadores

TIPO 1

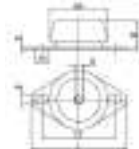

TIPO 2

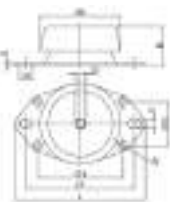

TIPO 3

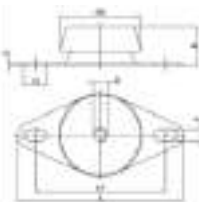

MOD.	MODELO AMORTIGUADORES	TIPO	eA	B	D	CF	CF1	CF2	F	øF1	L	M	S
CAMD 400	CF 623110	1	67	33...34	10	76,5	-	-	9	-	90,5	16	2
CAMD 450	CF 623110	1	67	33...34	10	76,5	-	-	9	-	90,5	16	2
CAMD 500	CF 623110	1	67	33...34	10	76,5	-	-	9	-	90,5	16	2
CAMD 560	CF 623110	1	67	33...34	10	76,5	-	-	9	-	90,5	16	2
CAMD 630	CF 623110	1	67	33...34	10	76,5	-	-	9	-	90,5	16	2
CAMD 710	CF 623110	1	67	33...34	10	76,5	-	-	9	-	90,5	16	2
CAMD 800	CF 924512	2	92	44...45	12	120	98	50	10,5	8,5	130	15,5	2,5
CAMD 900	CF 924512	2	92	44...45	12	120	98	50	10,5	8,5	130	15,5	2,5
CAMD 1000	CF 924512	2	92	44...45	12	120	98	50	10,5	8,5	130	15,5	2,5
CAMD 1120	CF 924512	2	92	44...45	12	120	98	50	10,5	8,5	130	15,5	2,5
CAMD 1250	CF 924512	2	92	44...45	12	120	98	50	10,5	8,5	130	15,5	2,5
CAMD 1400	CF 924512	2	92	44...45	12	120	98	50	10,5	8,5	130	15,5	2,5
CAMD-1600	CF 1204516	3	92	45	26,5	149,5	-	-	14	-	190	16	3,5
CAMD-1800	CF 1204516	3	92	45	26,5	149,5	-	-	14	-	190	16	3,5
CAMD-2000	CF 1204516	3	92	45	26,5	149,5	-	-	14	-	190	16	3,5

Silenciadores circulares

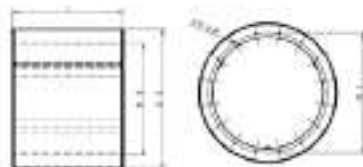

Los silenciadores se utilizan para bajar el nivel sonoro en instalaciones de acondicionamiento o ventilación, fabricados en acero cincado

- Bajo demanda: otras construcciones en diferentes materiales.

øD	øE	L	øI	F	øM
315	515	ØD,1.5ØD, 2ØD	355	8	M8
355	555	ØD,1.5ØD, 2ØD	395	8	M8
400	600	ØD,1.5ØD, 2ØD	450	8	M8
450	650	ØD,1.5ØD, 2ØD	500	8	M8
500	700	ØD,1.5ØD, 2ØD	560	12	M8
560	760	ØD,1.5ØD, 2ØD	620	12	M8
630	830	ØD,1.5ØD, 2ØD	690	12	M8
710	910	ØD,1.5ØD, 2ØD	770	16	M8
800	1000	ØD,1.5ØD, 2ØD	860	16	M8

øD	øE	L	øI	F	øM
900	1100	ØD,1.5ØD, 2ØD	970	16	M10
1000	1200	ØD,1.5ØD, 2ØD	1070	16	M10
1120	1320	ØD,1.5ØD, 2ØD	1190	20	M10
1250	1450	ØD,1.5ØD, 2ØD	1320	20	M10
1400	1600	ØD,1.5ØD, 2ØD	1470	20	M10
1500	1700	ØD,1.5ØD, 2ØD	1570	20	M10
1600	1800	ØD,1.5ØD, 2ØD	1680	24	M14
1700	1900	ØD,1.5ØD, 2ØD	1780	24	M14
1800	2000	ØD,1.5ØD, 2ØD	1880	24	M14

MOTOR DIRECTO

CASB

Ventiladores centrífugos de alta presión y simple aspiración de gran robustez con envolvente y turbina en chapa de acero

Diseñados para aire con polvo



SISTEMA

4



* Las imágenes son solo a nivel ilustrativo, el producto puede variar en función del tamaño, especificaciones y posición.

Ventilador:

- Envolvente en chapa de acero.
- Turbina a reacción en chapa de acero de gran robustez, especialmente diseñados para aire con polvo y materiales en suspensión de tamaño reducido.
- Motor directamente acoplado.
- Con trampilla de inspección y limpieza a partir del tamaño 560.
- Los tamaños superiores a 1600, se suministran con carcasa partida para facilitar el transporte.
- Carcasa soldada en continuo a partir del tamaño 710.

Motor:

- Motores con eficiencia IE3 para potencias iguales o superiores a 0,75 kW, excepto monofásicos, 2 velocidades y 8 polos.
- Motores clase F con rodamientos a bolas. Protección IP55.
- Trifásicos 230/400 V 50 Hz (hasta 4 kW) y 400/690 V 50 Hz (potencias superiores a 4 kW).
- Temperatura máxima del aire a transportar: -25 °C +90 °C.

Acabado:

- Anticorrosivo en resina de poliéster polimerizada a 190 °C, previo desengrase con tratamiento nanotecnológico libre de fosfatos.

Bajo demanda:

- Bobinados especiales para diferentes tensiones.
- Ventilador preparado para transportar aire hasta +150 °C.
- Ejecuciones especiales para temperaturas +300 °C.
- Ventilador en acero inoxidable.
- Certificación ATEX Categoría 2.
- Acoplamiento elástico sistema 8.

Código de pedido

CASB — 450 — 2T — 10

CASB: Ventiladores centrífugos de alta presión y simple aspiración de gran robustez

Tamaño turbina

Número de polos motor
2=2900 r/min 50 Hz
4=1400 r/min 50 Hz
6=900 r/min 50 Hz

T=Trifásico

Potencia motor (CV)

Formas constructivas motor directo

SISTEMA

4

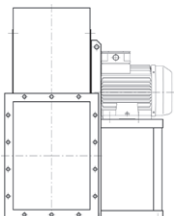

Accionamiento directo, turbina montada en el eje motor, montado sobre la silleta.

SISTEMA

5

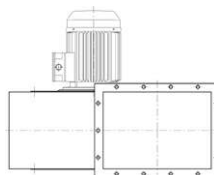

Accionamiento directo, turbina montada en el eje motor, motor de brida montado sobre la carcasa del ventilador.

SISTEMA

8

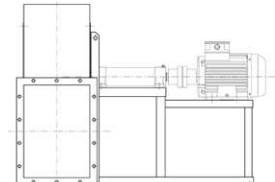

Accionamiento por acoplamiento elástico, turbina montada en el eje soporte, montado al motor mediante acoplamiento elástico. Todo montado conjuntamente sobre la silleta ventilador.

Orientaciones

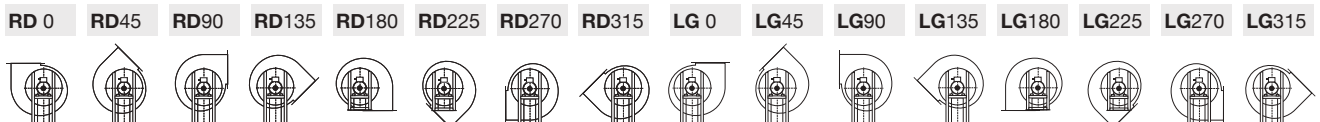

Suministro estándar LG270, otras posiciones bajo demanda. Modelos del 350 a 710 orientables. Medidas especiales en posiciones 180 y 225. Modelos del 800 al 900 orientables. Medidas especiales excepto posición 315. Modelos del 1000 al 1400 no orientables. Medidas especiales excepto posición 315.

Características técnicas

Modelo	Frame	Velocidad (r/min)	Intensidad máx admisible (A)			Potencia instalada (kW)	Caudal máximo (m³/h)	Nivel Presión Sonora dB(A)	Peso aprox (Kg)	According ErP
			230 V	400 V	690 V					
CASB-350-2T-3 IE3	90L	2910	7,32	4,21		2,20	3950	70	73	2015
CASB-400-2T-5.5 IE3	112M	2900	13,00	7,50		4,00	5550	74	108	2015
CASB-450-2T-10 IE3	132SB	2935		13,90	8,06	7,50	7900	77	150	2015
CASB-500-2T-15 IE3	160MA	2945		20,00	11,60	11,00	10800	80	230	2015
CASB-500-4T-1.5 IE3	90S	1455	4,07	2,34		1,10	5020	62	133	2015
CASB-560-2T-20 IE3	160MB	2945		27,70	16,10	15,00	13750	83	282	2015
CASB-560-2T-25 IE3	160L	2945		33,90	19,70	18,50	15900	83	292	2015
CASB-560-4T-3 IE3	100LA	1435	7,93	4,56		2,20	7800	65	139	2015
CASB-630-2T-40 IE3	200LA	2960		54,50	31,60	30,00	19450	86	382	2015
CASB-630-2T-50 IE3	200LB	2960		67,80	39,30	37,00	22700	88	392	2015
CASB-630-4T-5.5 IE3	112M	1450	13,90	8,00		5,50	10900	71	223	2015
CASB-710-4T-7.5 IE3	132S	1465		10,30	5,97	5,50	13000	71	295	2015
CASB-710-4T-10 IE3	132MA	1465		13,90	8,06	7,50	15300	73	281	2015
CASB-800-4T-15 IE3	160L	1470		20,90	12,10	11,00	19300	76	421	2015
CASB-800-4T-20 IE3	160L	1465		27,90	16,20	15,00	22450	76	396	2015
CASB-800-6T-5.5 IE3	132MA	960	15,60	8,99		4,00	13700	66	335	2015
CASB-900-4T-30 IE3	180M	1470		41,00	23,80	22,00	27550	78	581	2015
CASB-900-4T-40 IE3	200L	1480		57,10	33,10	30,00	31800	79	672	2015
CASB-900-6T-10 IE3	160M	975		14,80	8,58	7,50	19550	68	486	2015
CASB-1000-4T-50 IE3	225S	1480		66,80	38,70	37,00	38600	82	752	2015
CASB-1000-4T-60 IE3	225M	1475		80,90	46,90	45,00	42900	84	759	2015
CASB-1000-6T-15 IE3	160L	975		21,90	12,70	11,00	26750	73	614	2015
CASB-1000-6T-20 IE3	180L	975		28,20	16,30	15,00	29700	73	640	2015
CASB-1120-4T-75 IE3	250M	1480		98,60	57,20	55,00	55100	86	1143	2015
CASB-1120-4T-100 IE3	280S	1485		134,00	77,70	75,00	63050	86	1215	2015
CASB-1120-6T-25 IE3	200LR	980		35,90	20,80	18,50	38000	76	969	2015
CASB-1120-6T-30 IE3	200L	980		42,40	24,60	22,00	41600	77	991	2015
CASB-1250-4T-150 IE3	315S	1490		193,00	112,00	110,00	78600	89	1466	2015
CASB-1250-4T-175 IE3	315MA	1490		231,00	134,00	132,00	87500	90	1537	2015
CASB-1250-6T-40 IE3	225M	985		55,40	32,10	30,00	51550	79	1222	2015
CASB-1250-6T-50 IE3	250M	985		67,20	39,00	37,00	57400	79	1319	2015
CASB-1400-6T-60 IE3	280S	985		84,40	48,90	45,00	64350	81	1829	2015
CASB-1400-6T-100 IE3	315S	990		139,00	80,60	75,00	85800	83	1951	2015



Erp. (Energy Related Products)

Información de la Directiva 2009/125/EC descargable desde la web de SODECA o programa de selección QuickFan

Curvas Características

Q= Caudal en m³/h, m³/s y cfm

Pe= Presión estática en mmH₂O, Pa e inwg

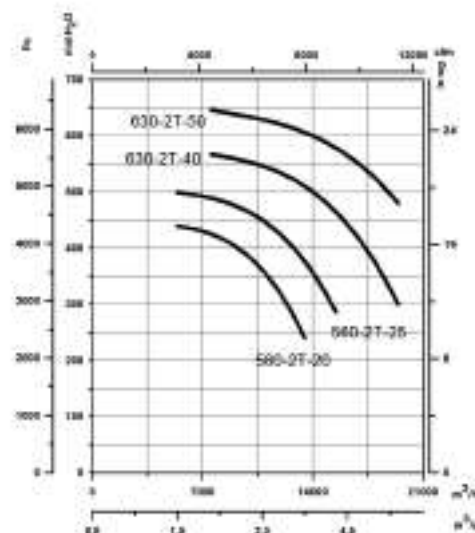
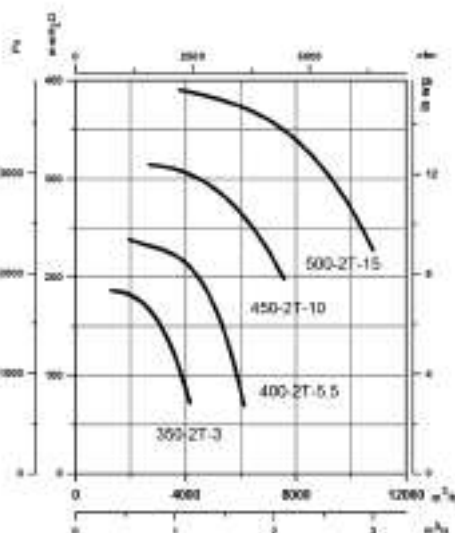

Curvas Características

Q= Caudal en m³/h, m³/s y cfm

Pe= Presión estática en mmH₂O, Pa e inwg

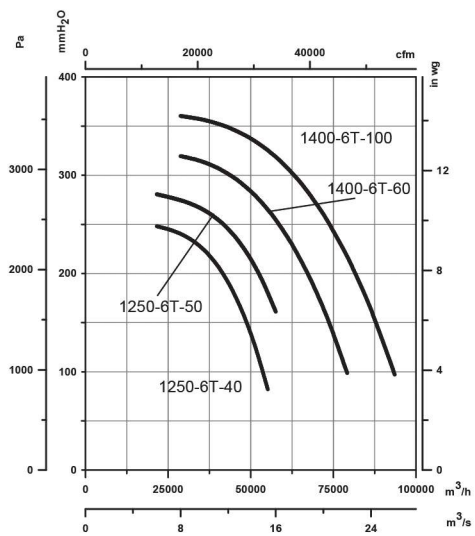
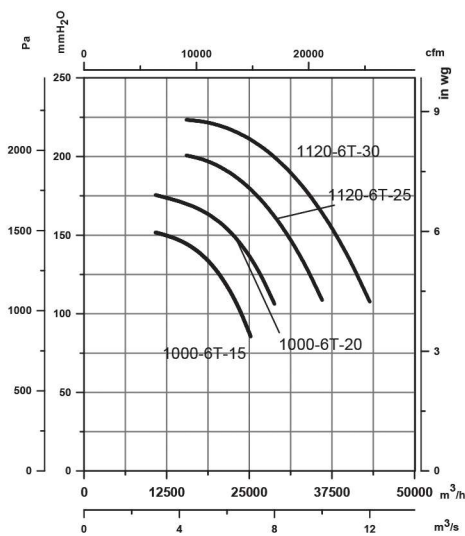
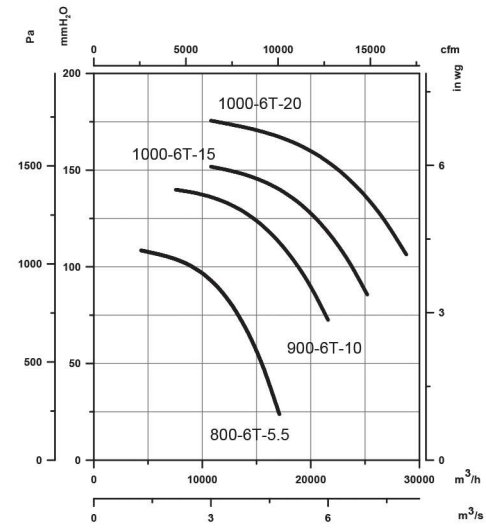
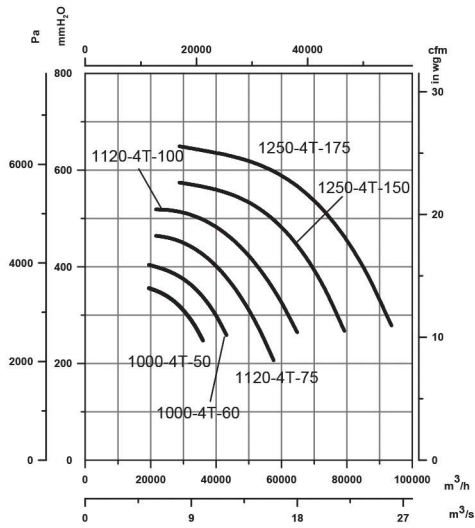
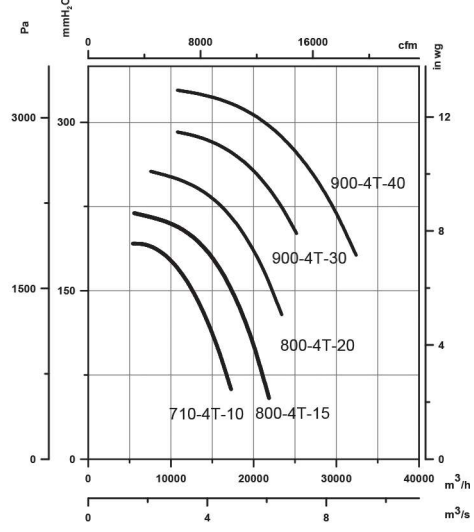
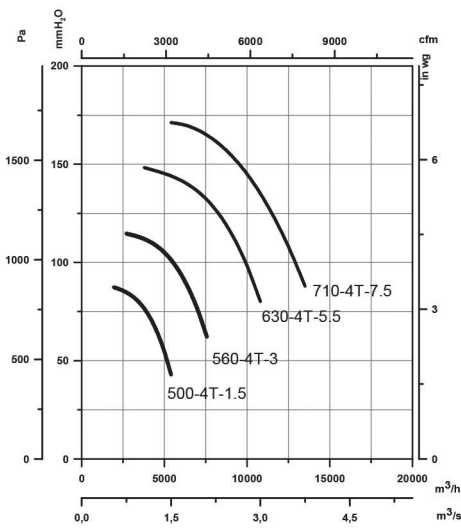

LARGE SERIES

Accesorios



MOTOR A TRANSMISIÓN

CASB-X

Ventiladores de alta presión accionados a transmisión, equipados con motor eléctrico, conjunto de poleas, correas y protectores normalizados según norma ISO-13857

Diseñados para aire con polvo



- Carcasa soldada en continuo a partir del tamaño 710.

Motor:

- Motores con eficiencia IE3.
- Motores clase F con rodamientos a bolas. Protección IP55.
- Trifásicos 230/400 V 50 Hz (hasta 4 kW) y 400/690 V 50 Hz (potencias superiores a 4 kW).
- Temperatura máxima del aire a transportar: -25 °C +90 °C.

Acabado:

- Anticorrosivo en resina de poliéster polimerizada a 190 °C, previo desengrase con tratamiento nanotecnológico libre de fosfatos.

Bajo demanda:

- Bobinados especiales para diferentes tensiones.
- Ventilador preparado para transportar aire hasta +300 °C.
- Ventilador en acero inoxidable.
- Certificación ATEX Categoría 2.
- Acoplamiento elástico sistema 8.

Ventilador:

- Envoltente en chapa de acero.
- Turbina a reacción en chapa de acero de gran robustez, especialmente diseñados para aire con polvo y materiales en suspensión de tamaño reducido.
- Motor montado sobre bancada general.
- Con trampilla de inspección y limpieza a partir del tamaño 560.
- Los tamaños superiores a 1600, se suministran con carcasa partida para facilitar el transporte.

* Las imágenes son solo a nivel ilustrativo, el producto puede variar en función del tamaño, especificaciones y posición.

Formas constructivas motor a transmisión

SISTEMA 12

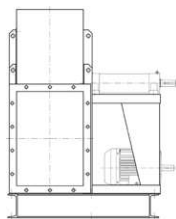

Accionamiento a transmisión, igual al SISTEMA 1, con el motor y ventilador montados en la bancada común. Posiciones de motor "W" o "Z" y excepcionalmente "X" o "Y".

SISTEMA 9

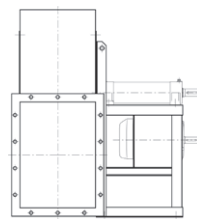

Accionamiento a transmisión, igual al SISTEMA 1, con el motor montado en el lateral de la silleta, en posición "W" o "Z".

SISTEMA 1

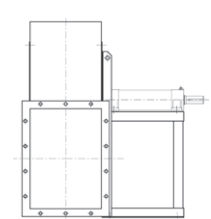

Accionamiento a transmisión, turbina montada en el eje soporte. Soporte montado sobre la silleta.

Orientaciones

RD 0 RD45 RD90 RD135 RD180 RD225 RD270 RD315

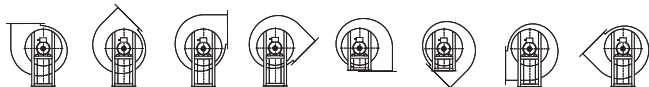

LG 0 LG45 LG90 LG135 LG180 LG225 LG270 LG315

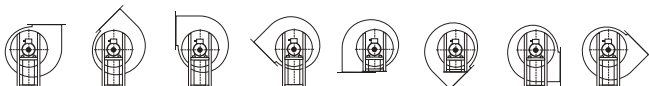

Curvas Características

CASB-X 250

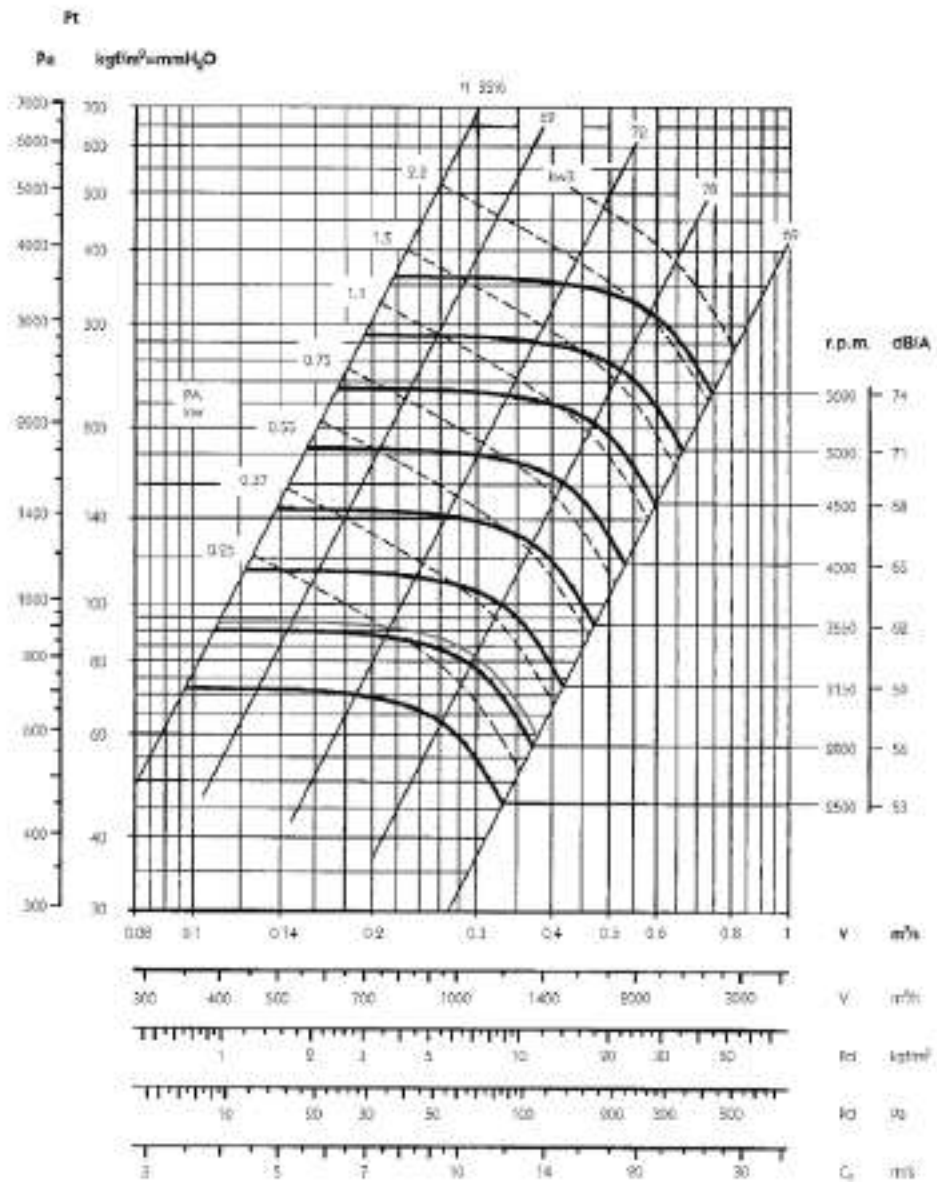

Margen sobre el caudal ± 5 %
 Margen del nivel sonoro +3...5db
 Margen kW absorbidos ± 3%

Características en impulsión.

Rpm máximas admisibles

Clase 1	
≤ 100 °C	5000
101 ... 200 °C	4500
201 ... 300 °C	4000

Curvas Características

CASB-X 280

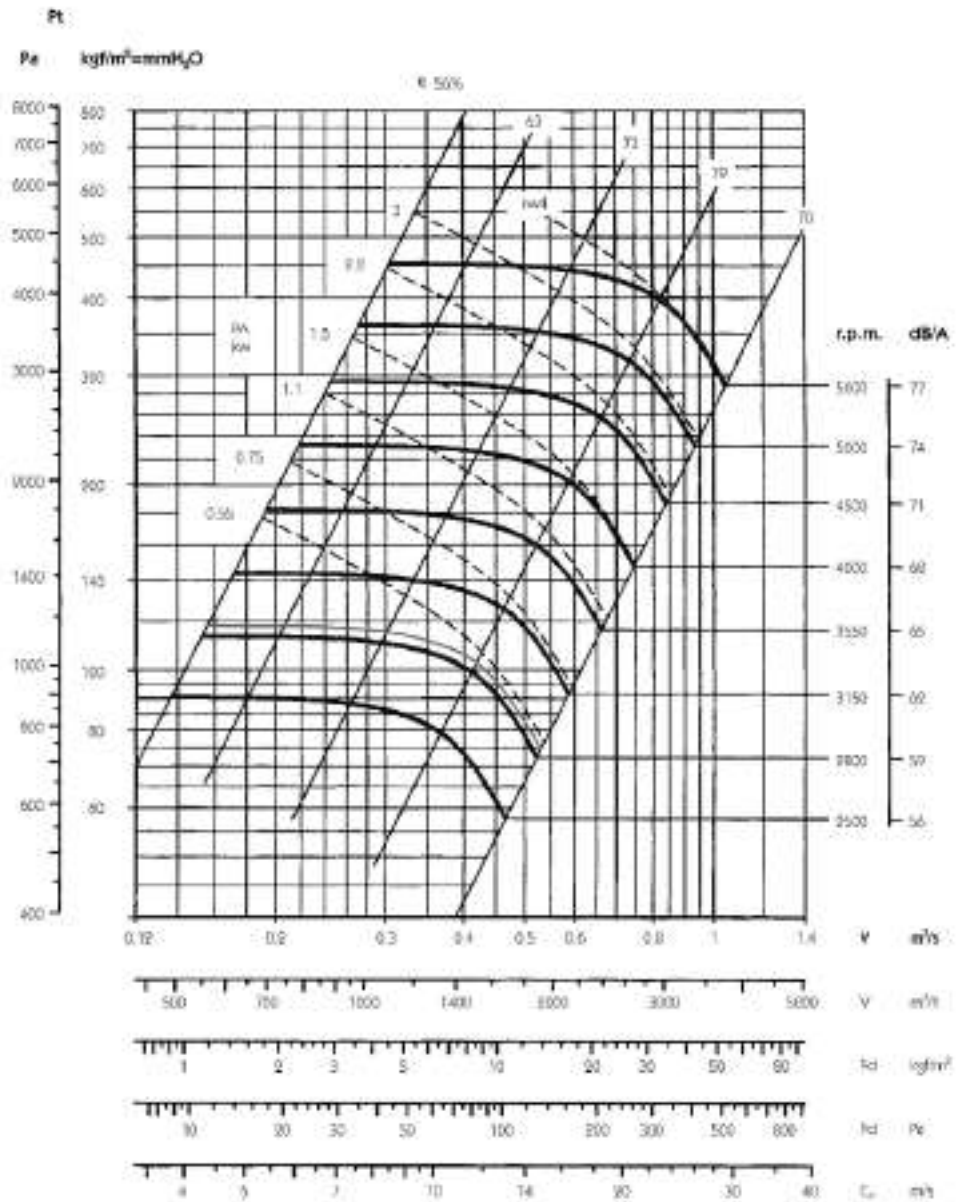

Margen sobre el caudal $\pm 5\%$
 Margen del nivel sonoro $+3...5\text{db}$
 Margen kW absorbidos $\pm 3\%$

Características en impulsión.

Rpm máximas admisibles

Clase 1	
$\leq 100\text{ }^{\circ}\text{C}$	4750
101 ... 200 $^{\circ}\text{C}$	4250
201 ... 300 $^{\circ}\text{C}$	3750

Curvas Características

CASB-X 310

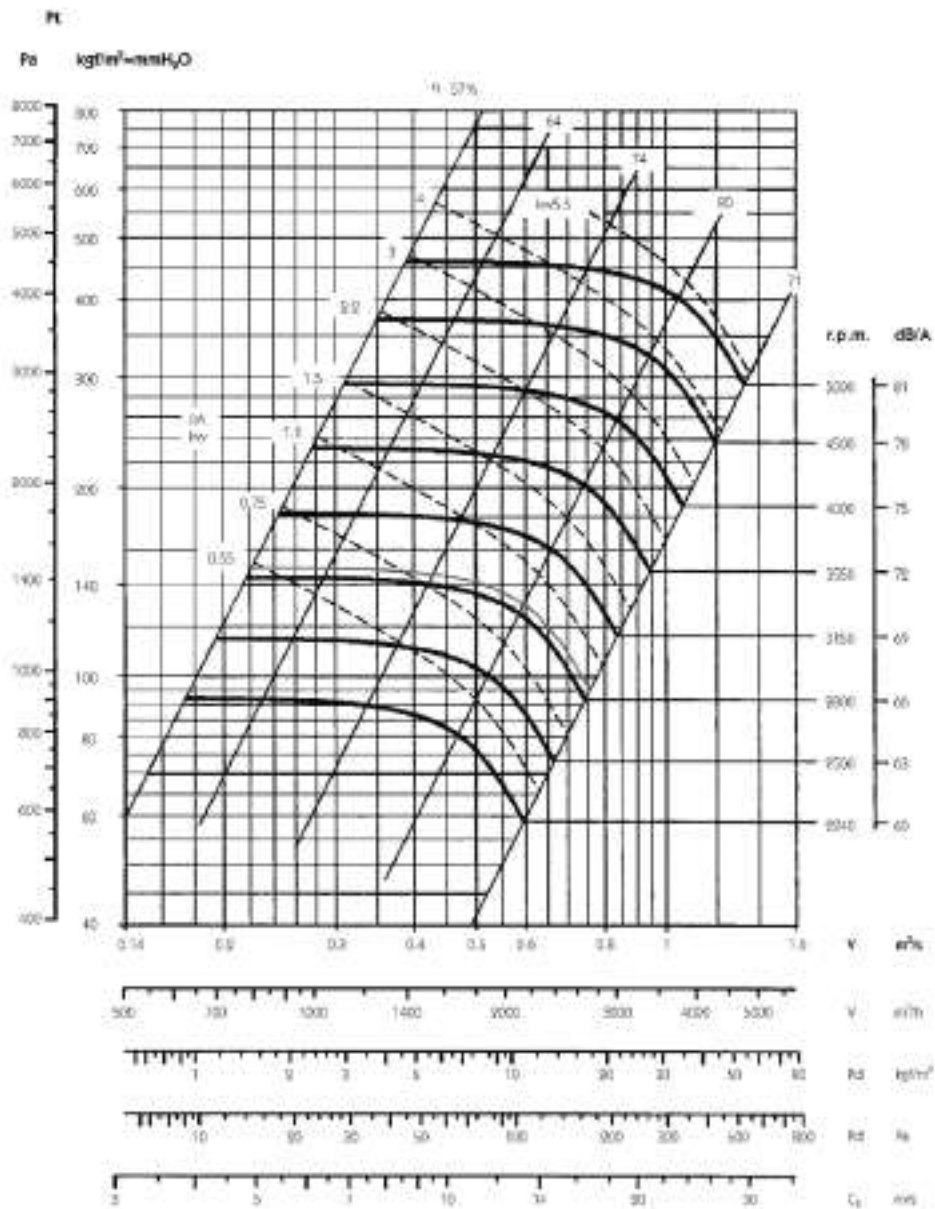

LARGE SERIES

Margen sobre el caudal ± 5 %
 Margen del nivel sonoro +3...5db
 Margen kW absorbidos ± 3%

Características en impulsión.

Rpm máximas admisibles

Clase 1	
≤ 100 °C	4500
101 ... 200 °C	4000
201 ... 300 °C	3550

Curvas Características

CASB-X 350

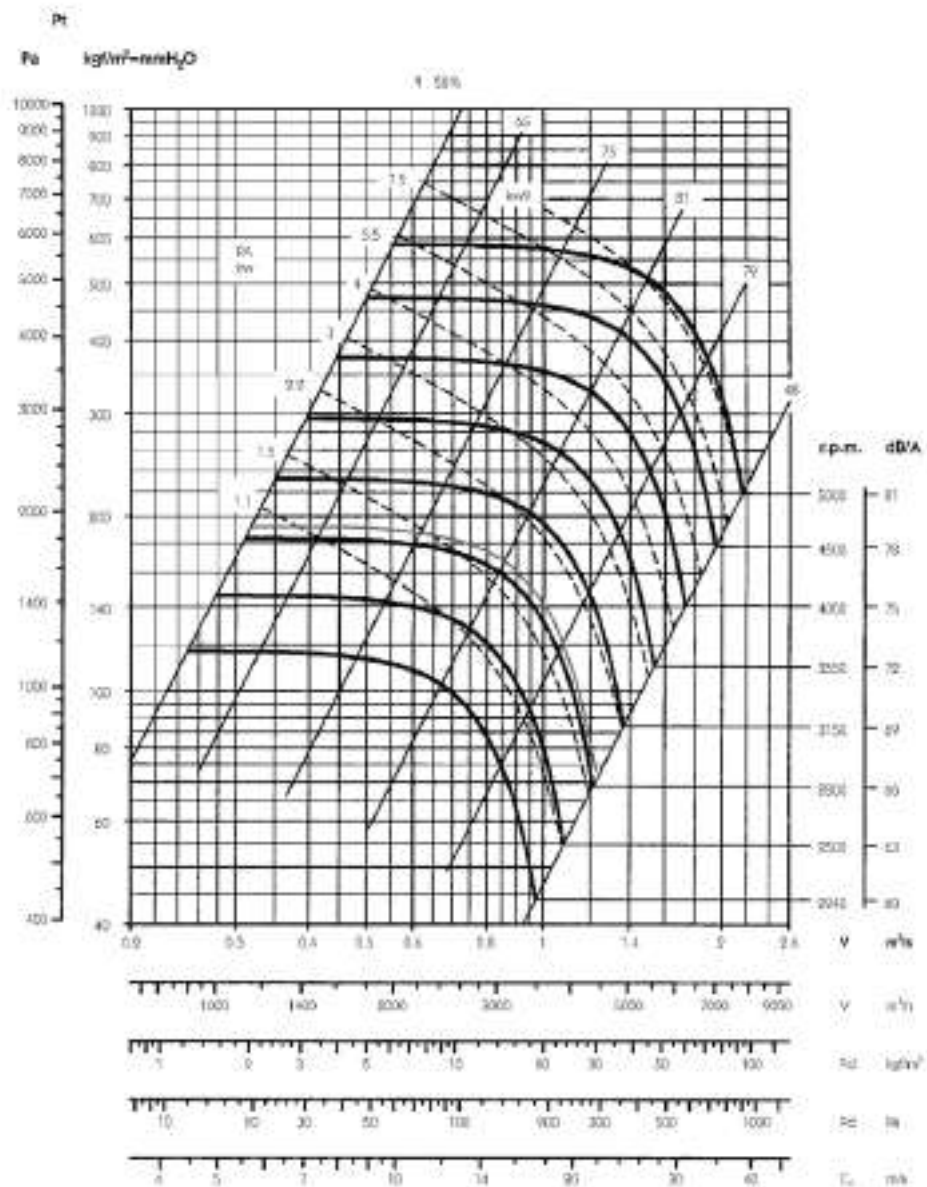

Margen sobre el caudal $\pm 5\%$
 Margen del nivel sonoro $+3...5\text{db}$
 Margen kW absorbidos $\pm 3\%$

Características en impulsión.

Rpm máximas admisibles

Clase 1	
$\leq 100\text{ }^\circ\text{C}$	4250
101 ... 200 $^\circ\text{C}$	3750
201 ... 300 $^\circ\text{C}$	3350

Curvas Características

CASB-X 400

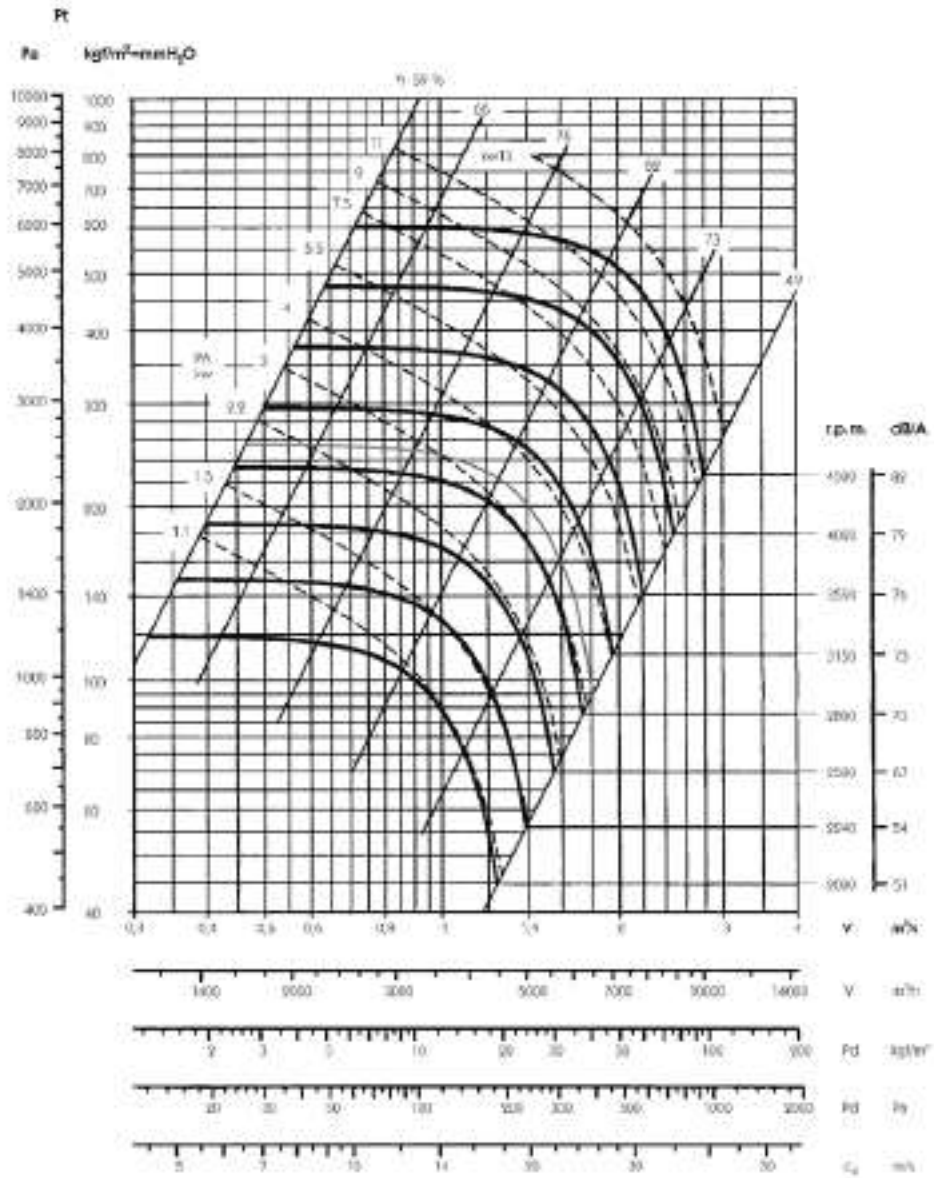

LARGE SERIES

Margen sobre el caudal ± 5 %
 Margen del nivel sonoro +3...5db
 Margen kW absorbidos ± 3%

Características en impulsión.

Rpm máximas admisibles

Clase 1	
≤ 100 °C	4000
101 ... 200 °C	3550
201 ... 300 °C	3150

Curvas Características

CASB-X 450

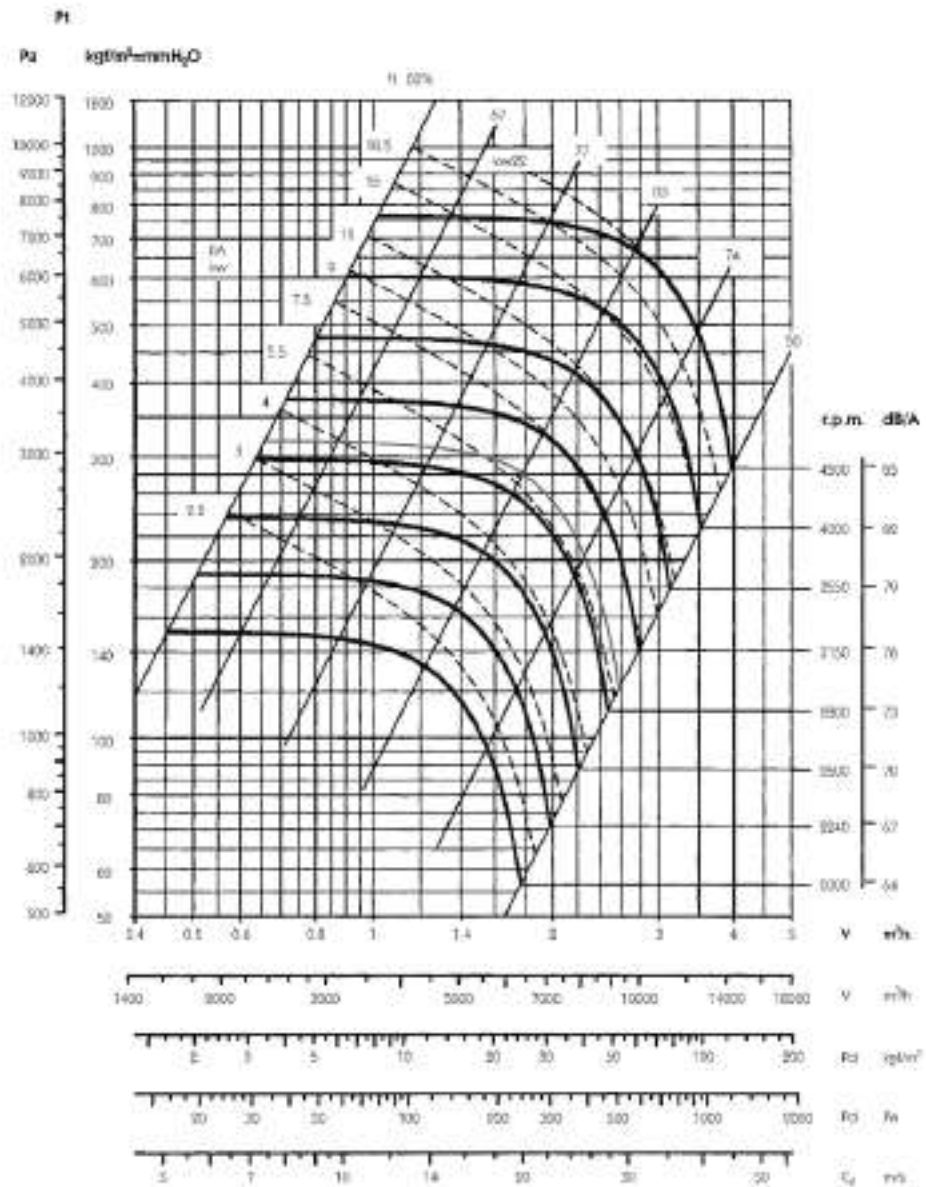

Margen sobre el caudal $\pm 5\%$
 Margen del nivel sonoro $+3...5\text{db}$
 Margen kW absorbidos $\pm 3\%$

Características en impulsión.

Rpm máximas admisibles

Clase 1	
$\leq 100^\circ\text{C}$	3750
101 ... 200 $^\circ\text{C}$	3350
201 ... 300 $^\circ\text{C}$	3000

Curvas Características

CASB-X 500

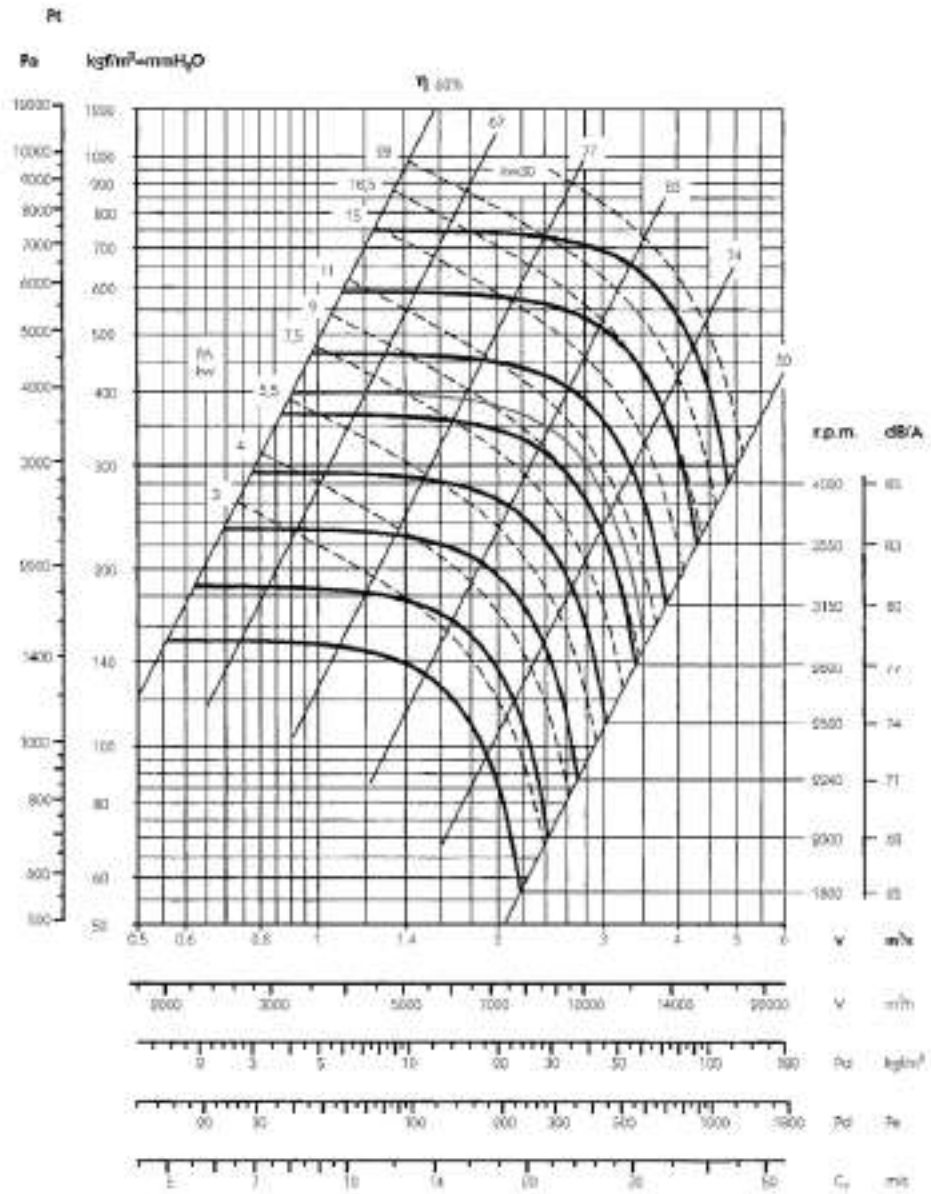

LARGE SERIES

Margen sobre el caudal ± 5 %
 Margen del nivel sonoro +3...5db
 Margen kW absorbidos ± 3%

Características en impulsión.

Rpm máximas admisibles

Clase 1	
≤ 100 °C	3550
101 ... 200 °C	3150
201 ... 300 °C	2800

Curvas Características

CASB-X 560

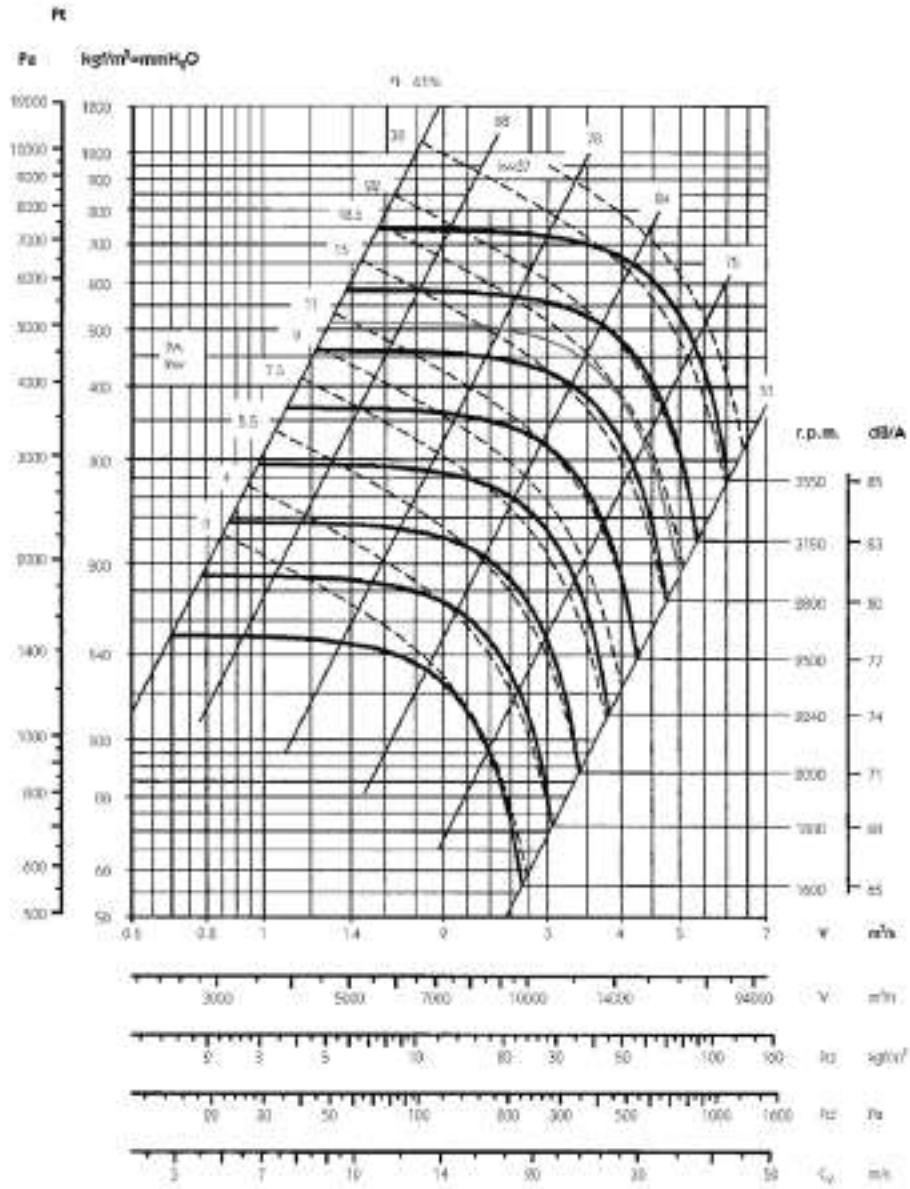

Margen sobre el caudal $\pm 5\%$
 Margen del nivel sonoro $+3...5\text{db}$
 Margen kW absorbidos $\pm 3\%$

Características en impulsión.

Rpm máximas admisibles

Clase 1	
$\leq 100\text{ }^\circ\text{C}$	3350
101 ... 200 $^\circ\text{C}$	3000
201 ... 300 $^\circ\text{C}$	2650

Curvas Características

CASB-X 630

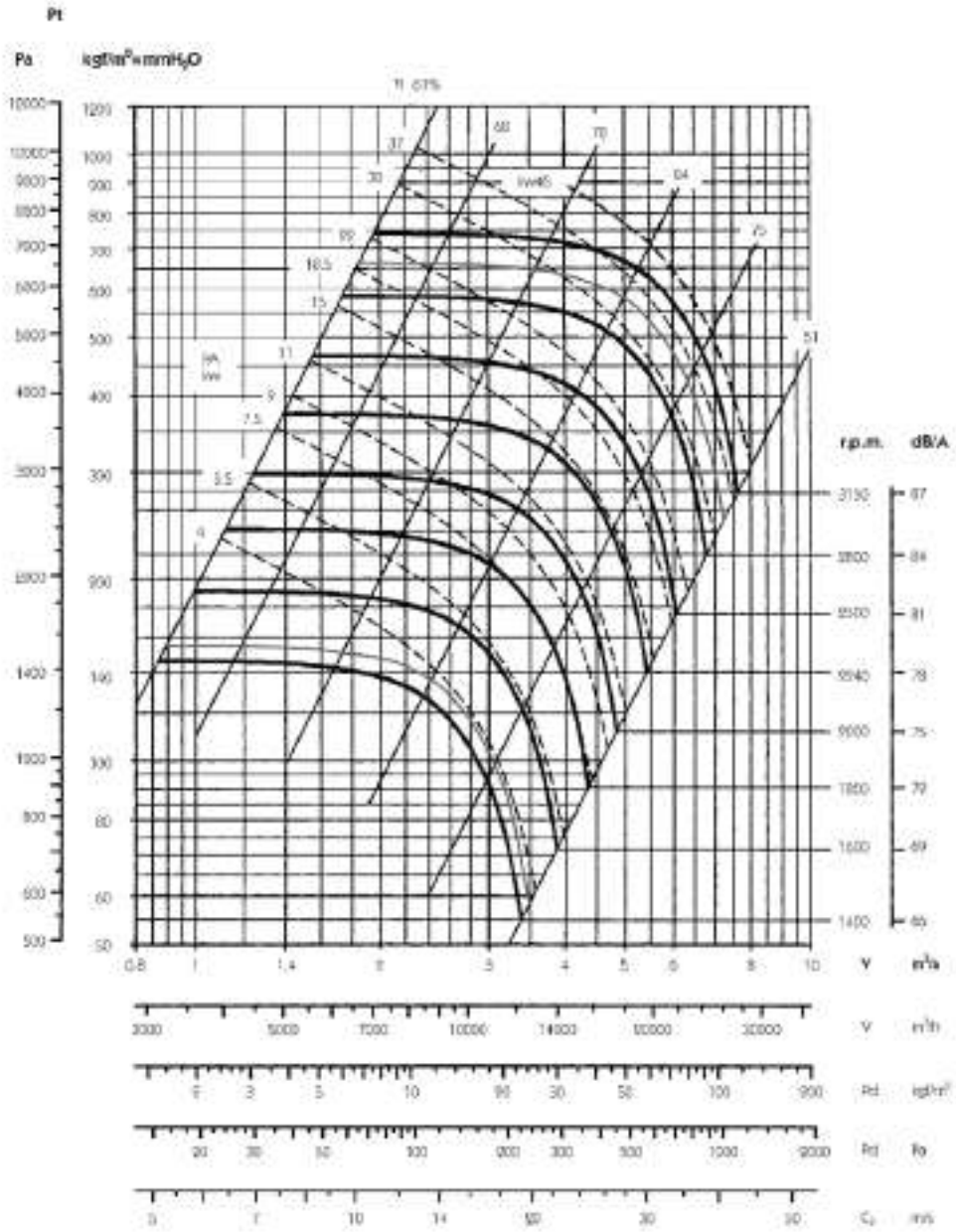

LARGE SERIES

Margen sobre el caudal $\pm 5\%$
 Margen del nivel sonoro $+3...5\text{db}$
 Margen kW absorbidos $\pm 3\%$

Características en impulsión.

Rpm máximas admisibles

Clase 1	
$\leq 100\text{ }^\circ\text{C}$	3150
101 ... 200 $^\circ\text{C}$	2800
201 ... 300 $^\circ\text{C}$	2500

Curvas Características

CASB-X 710

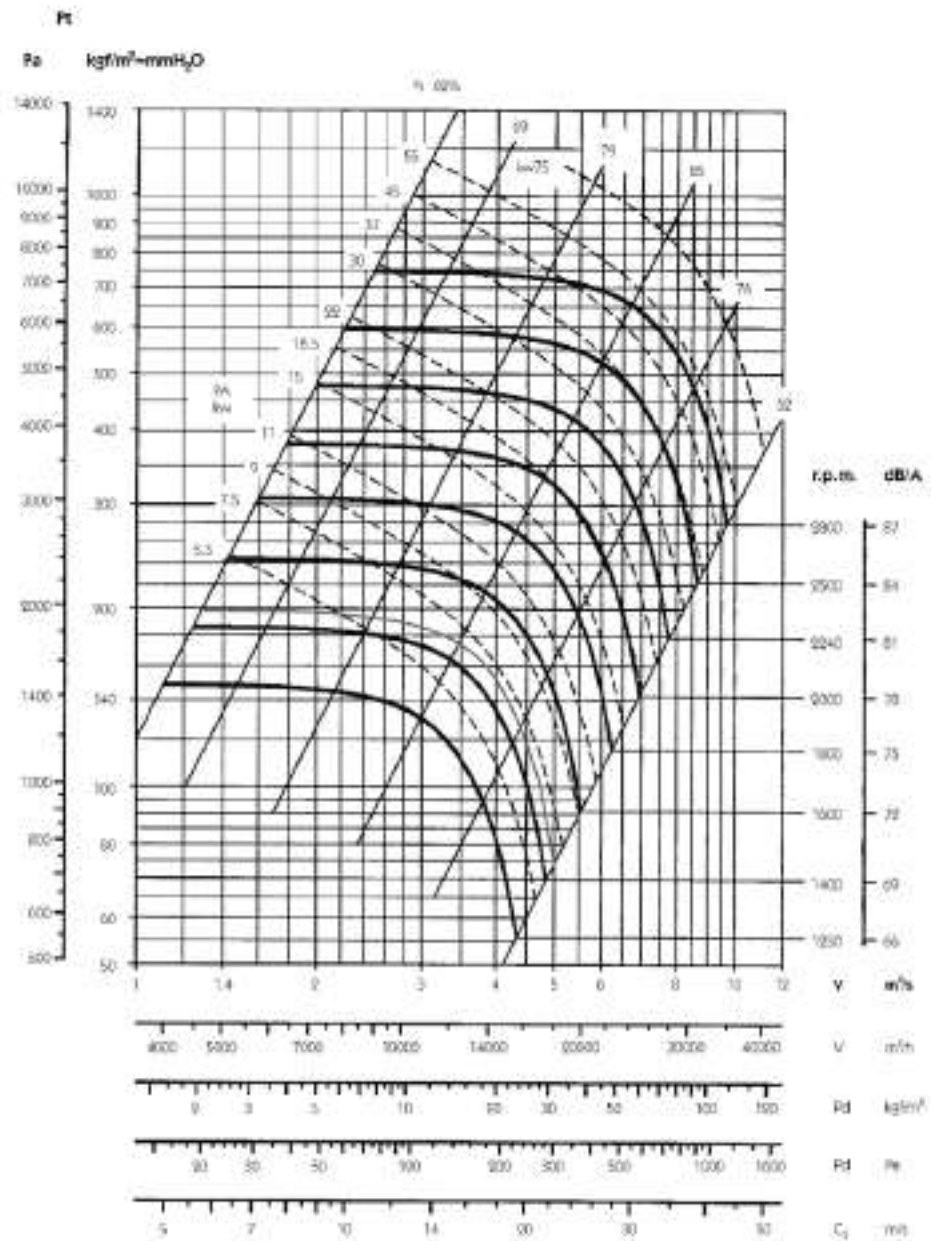

Margen sobre el caudal $\pm 5\%$
 Margen del nivel sonoro $+3...5\text{db}$
 Margen kW absorbidos $\pm 3\%$

Características en impulsión.

Rpm máximas admisibles

Clase 1	
$\leq 100\text{ }^{\circ}\text{C}$	2800
101 ... 200 $^{\circ}\text{C}$	2500
201 ... 300 $^{\circ}\text{C}$	2240

Curvas Características

CASB-X 800

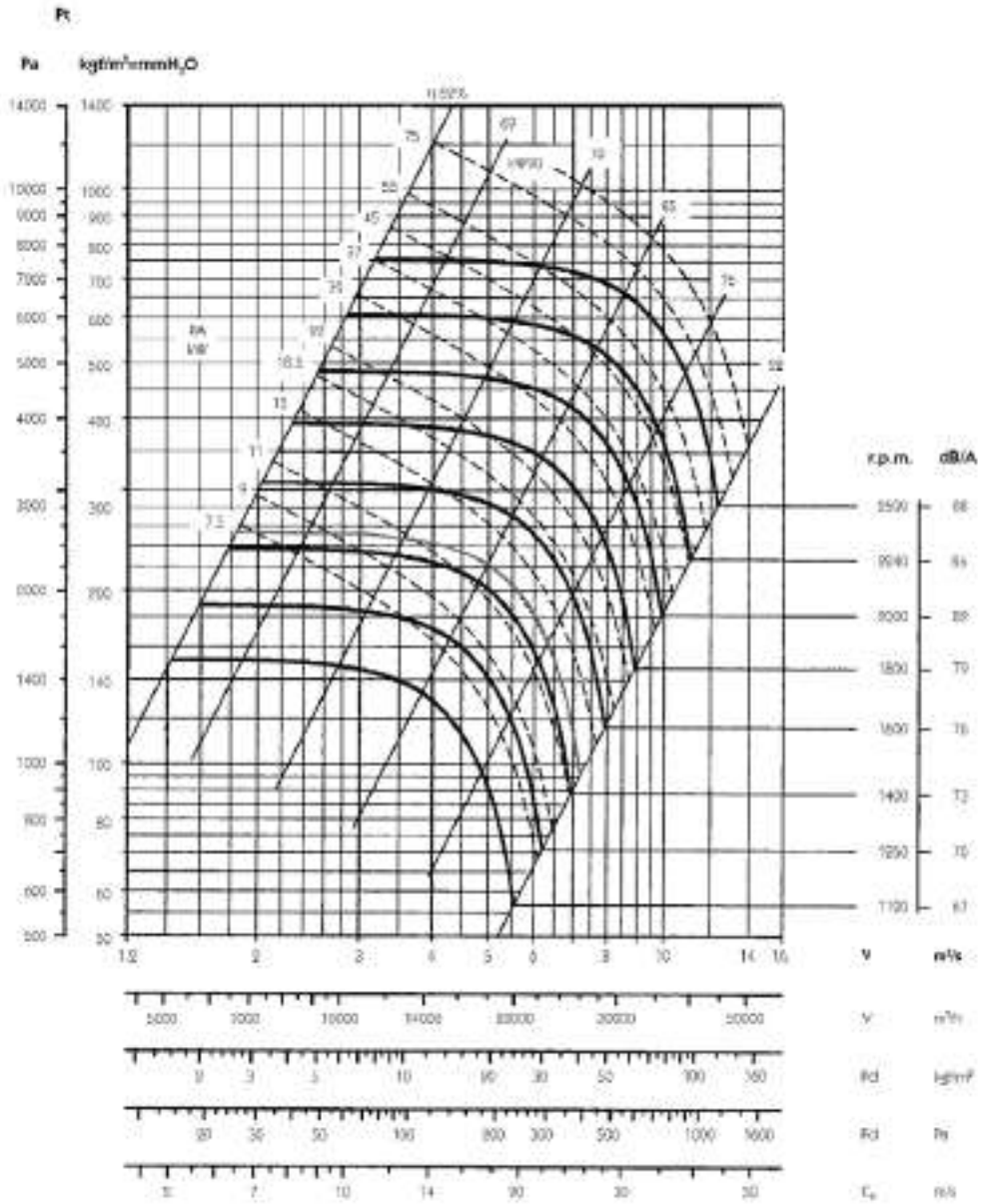

Curvas Características

CASB-X 1000

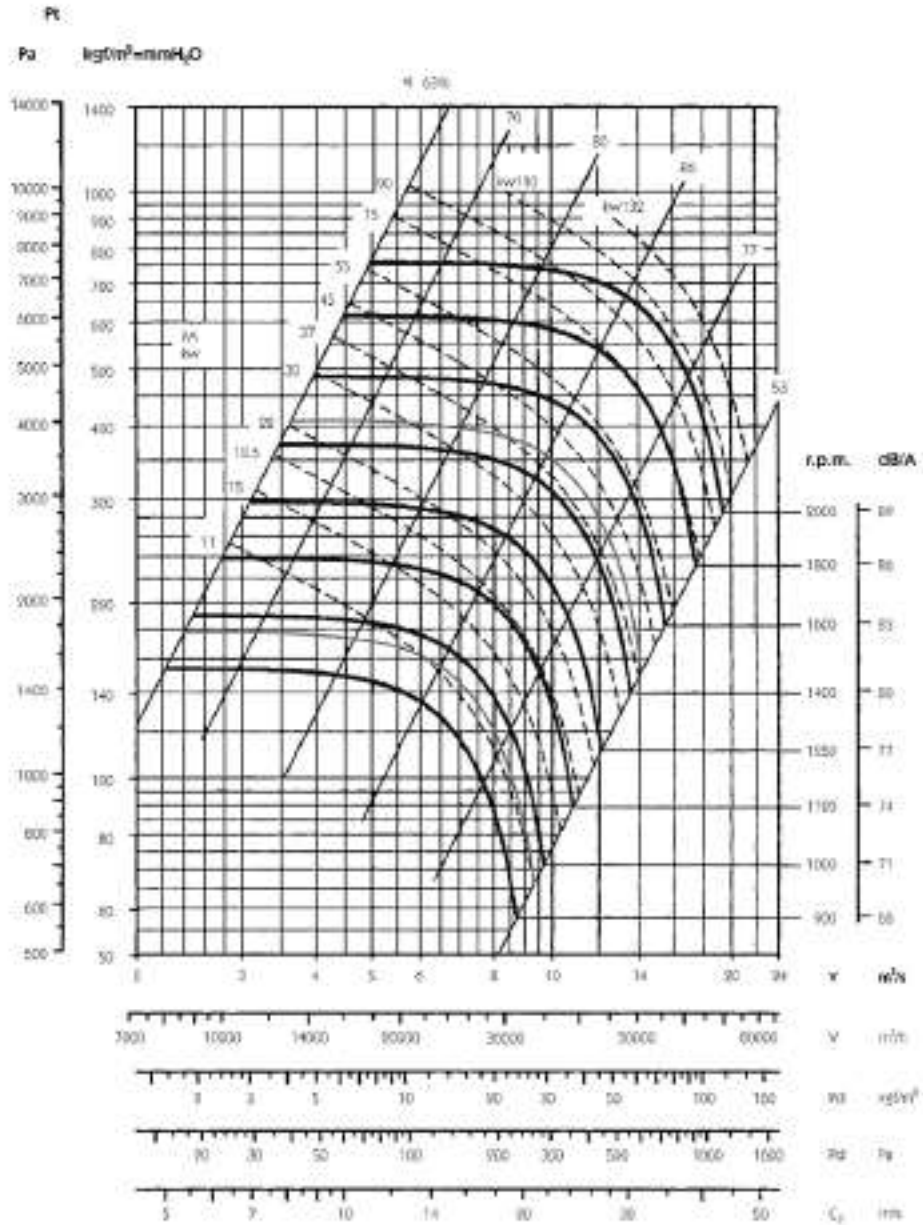

Margen sobre el caudal $\pm 5\%$
 Margen del nivel sonoro $+3...5\text{db}$
 Margen kW absorbidos $\pm 3\%$

Características en impulsión.

Rpm máximas admisibles

Clase 1	
$\leq 100\text{ }^\circ\text{C}$	2000
101 ... 200 $^\circ\text{C}$	1800
201 ... 300 $^\circ\text{C}$	1600

Curvas Características

CASB-X 1120

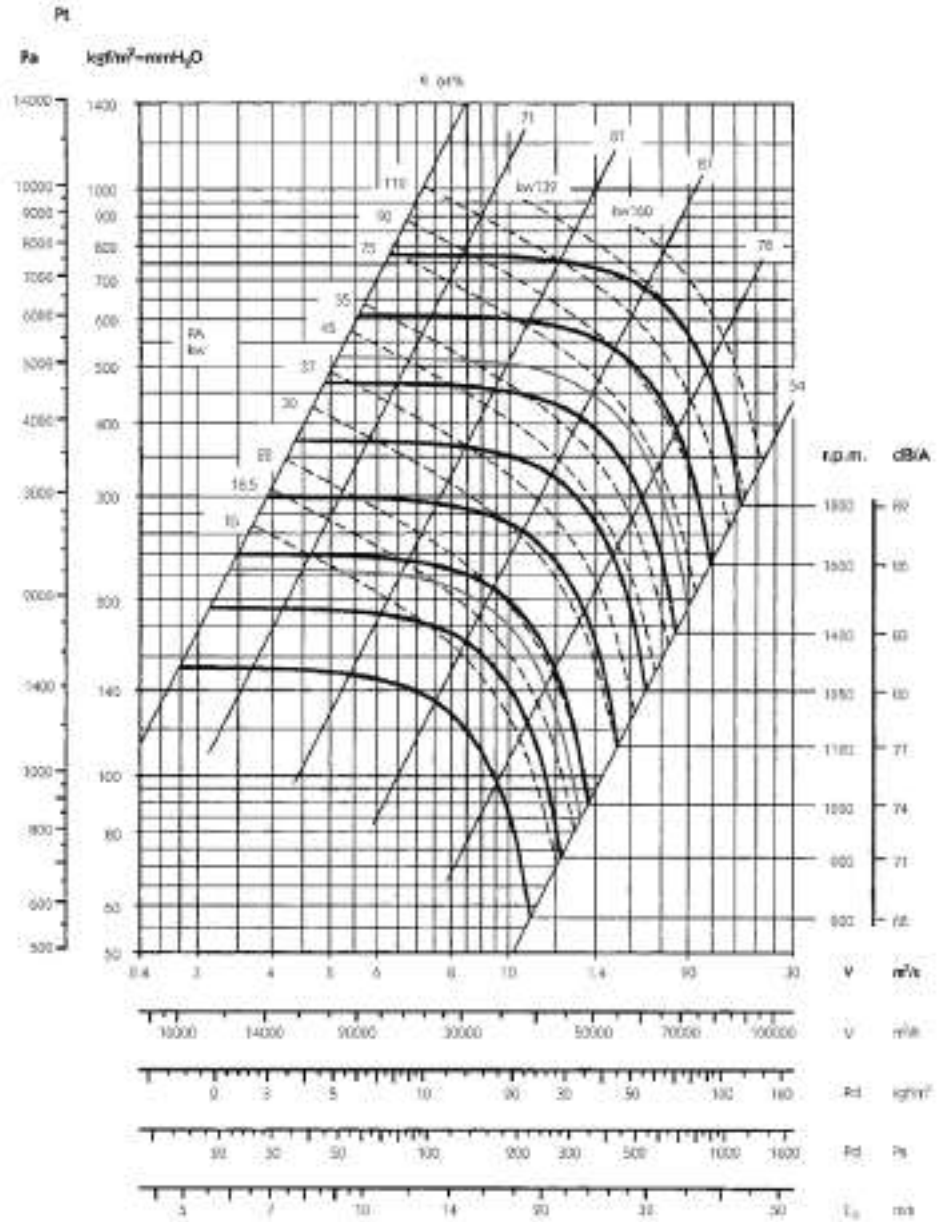

Margen sobre el caudal $\pm 5\%$
 Margen del nivel sonoro $+3...5\text{db}$
 Margen kW absorbidos $\pm 3\%$

Características en impulsión.

Rpm máximas admisibles

Clase 1	
$\leq 100\text{ }^\circ\text{C}$	1800
101 ... 200 $^\circ\text{C}$	1600
201 ... 300 $^\circ\text{C}$	1400

Curvas Características

CASB-X 1250

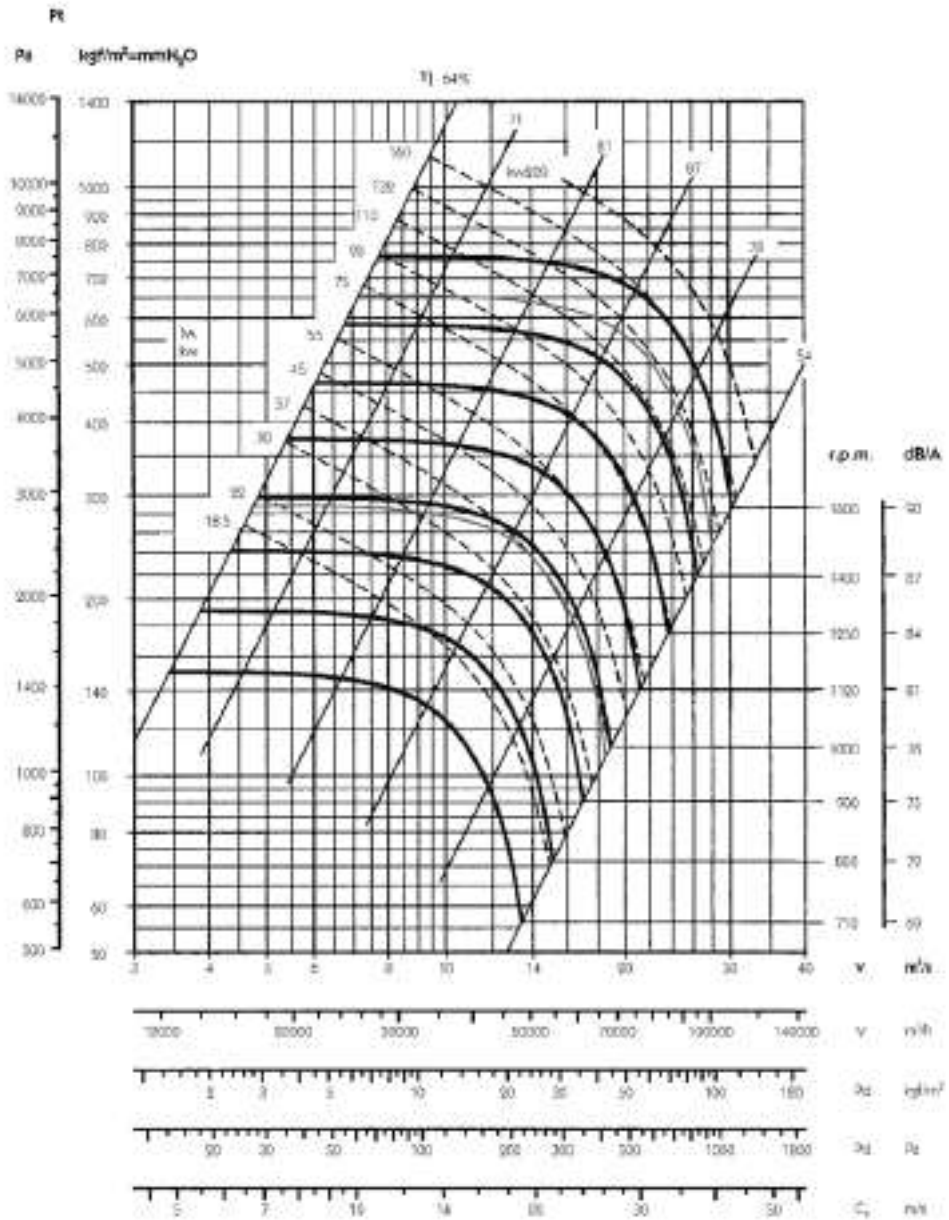

LARGE SERIES

Margen sobre el caudal ± 5 %
 Margen del nivel sonoro +3...5db
 Margen kW absorbidos ± 3%

Características en impulsión.

Rpm máximas admisibles

Clase 1	
≤ 100 °C	1600
101 ... 200 °C	1400
201 ... 300 °C	1250

Curvas Características

CASB-X 1400

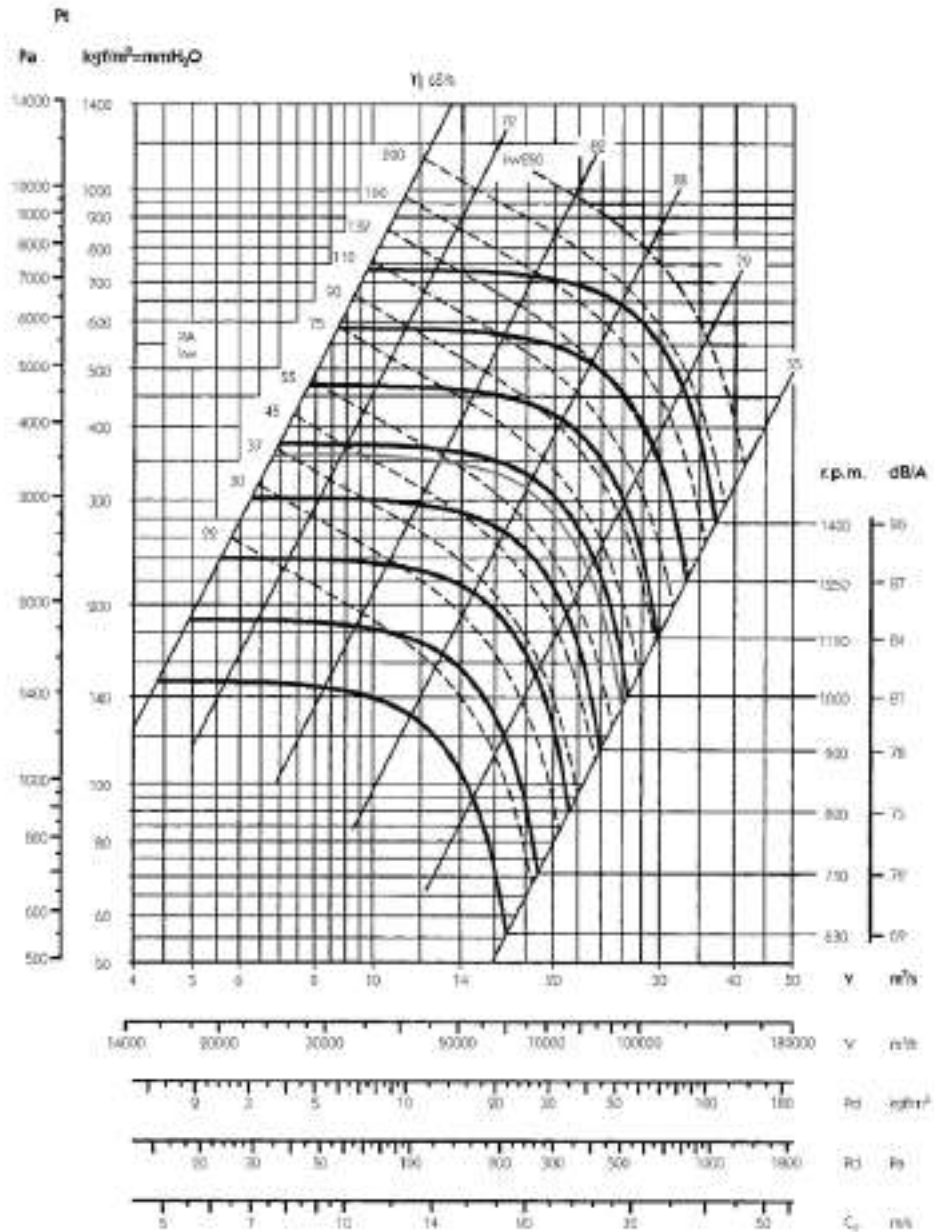

Margen sobre el caudal $\pm 5\%$
 Margen del nivel sonoro $+3...5\text{db}$
 Margen kW absorbidos $\pm 3\%$

Características en impulsión.

Rpm máximas admisibles

Clase 1	
$\leq 100\text{ }^\circ\text{C}$	1400
101 ... 200 $^\circ\text{C}$	1250
201 ... 300 $^\circ\text{C}$	1120

Curvas Características

CASB-X 1600

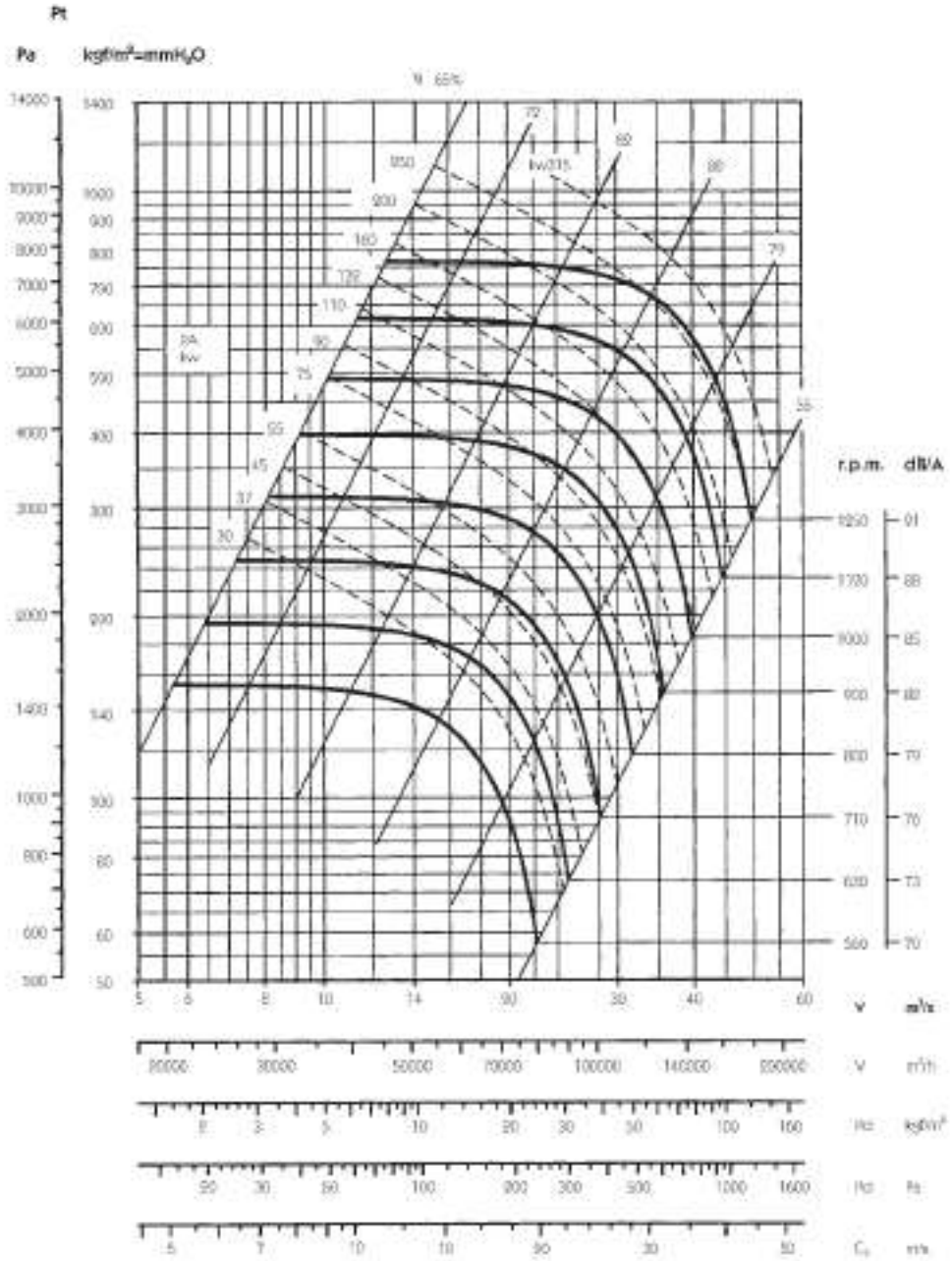

LARGE SERIES

Margen sobre el caudal ± 5 %
 Margen del nivel sonoro +3...5db
 Margen kW absorbidos ± 3%

Rpm máximas admisibles

Clase 1	
≤ 100 °C	1250
101 ... 200 °C	1120
201 ... 300 °C	1000

Curvas Características

CASB-X 1800

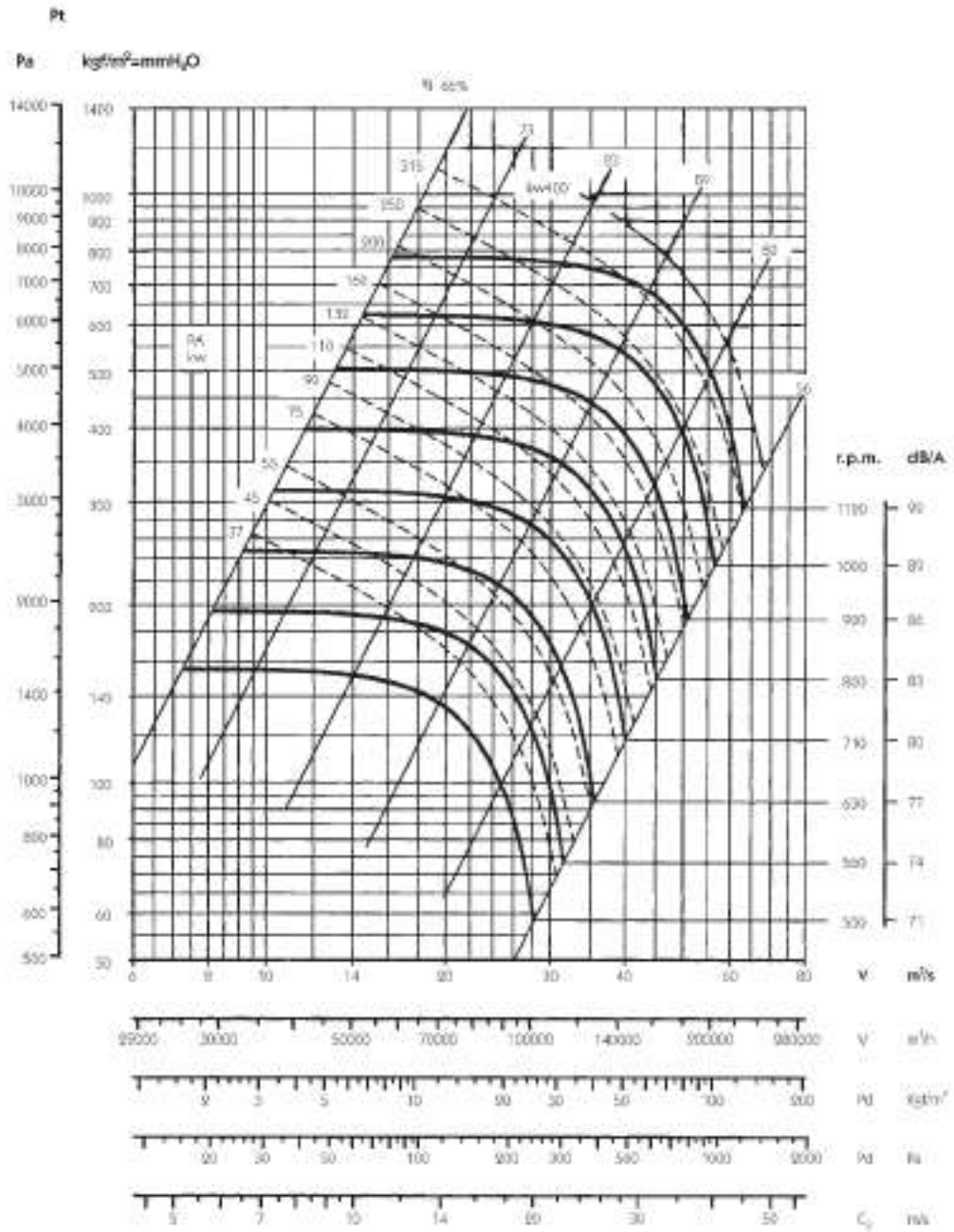

Margen sobre el caudal $\pm 5\%$
 Margen del nivel sonoro $+3...5\text{db}$
 Margen kW absorbidos $\pm 3\%$

Rpm máximas admisibles

Clase 1	
$\leq 100\text{ }^{\circ}\text{C}$	1120
101 ... 200 $^{\circ}\text{C}$	1000
201 ... 300 $^{\circ}\text{C}$	900

Curvas Características

CASB-X 2000

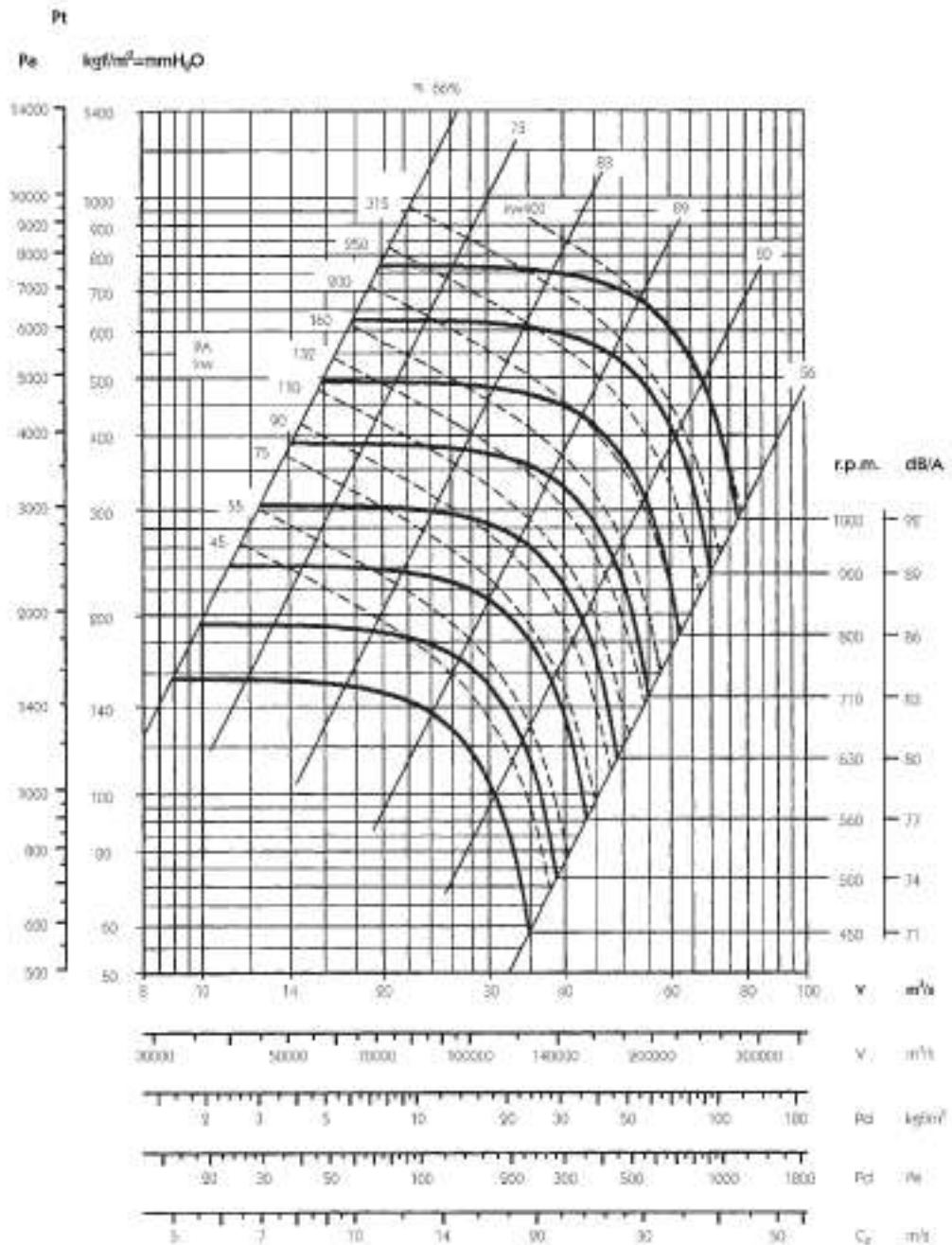

Margen sobre el caudal ± 5 %
 Margen del nivel sonoro +3...5db
 Margen kW absorbidos ± 3%

Rpm máximas admisibles

Clase 1	
≤ 100 °C	1000
101 ... 200 °C	900
201 ... 300 °C	800

Dimensiones mm

SISTEMA
4

CASB 350...500

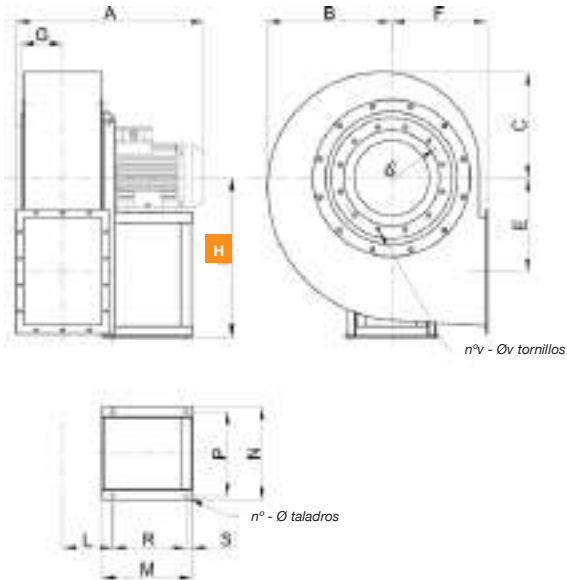

BOCA DE IMPULSIÓN

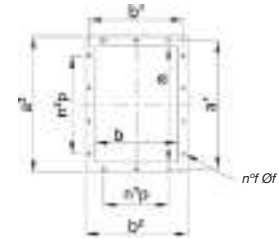

ORIENTACIONES

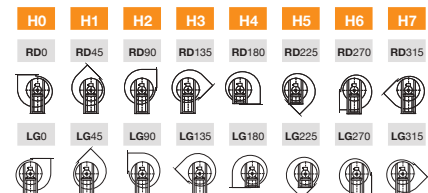

H * La medida de la cota H (distancia entre el suelo y el eje) varía según las orientaciones

MOD.	FRAME	A*	B	C	E	F	G	HO-1-2-3	H4-5	H6-7	L	M*	N	P	R*	S
CASB 350	90 L/2	535	335	285	253	255	114	450	255	450	155	215	269	245	140	25
CASB 400	112 M/2	585	380	320	286	285	128	500	285	500	168	260	312	280	185	25
CASB 450	132 SB/2	700	425	360	321	320	143	560	320	560	182	320	342	310	245	25
CASB 500	160 MA/2	805	470	405	355	360	158	600	360	600	198	425	440	400	345	30
CASB 500	90 S/4	590	470	405	355	360	158	600	360	600	198	215	269	245	140	25

BOCA IMPULSIÓN

MOD.	n°	Ø	d ¹	n°v	Øv	a	b	a ¹	b ¹	a ²	b ²	n°p	n°p	n°f	of	kg	WD ²
CASB 350	4	10	332	8	M8	288	205	332	249	368	285	1-125	2-125	10	12	65	0,4
CASB 400	4	12	366	8	M8	322	229	366	273	402	309	1-125	2-125	10	12	110	0,75
CASB 450	4	12	405	8	M8	361	256	405	300	441	336	1-125	2-125	10	12	145	1,1
CASB 500	4	14	448	12	M8	404	288	448	332	484	368	2-125	3-125	14	12	220	2,2
CASB 500	4	10	448	12	M8	404	288	448	332	484	368	2-125	3-125	14	12	125	2,3

(*) Para construcciones a "ALTA TEMP." cotas "A-M-R" + 50 mm.
(kg) Peso ventilador con motor.
WD² = Momento de inercia del rodete, expresado en Kg x m²

LARGE SERIES

Dimensiones mm

CASB 560...630

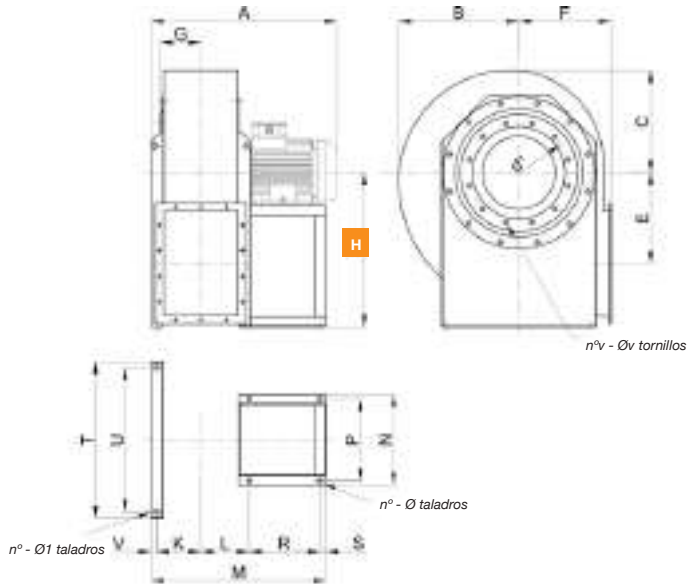

BOCA DE IMPULSIÓN

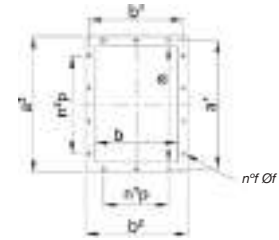

ORIENTACIONES

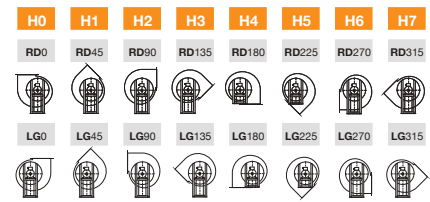

H * La medida de la cota H (distancia entre el suelo y el eje) varía según las orientaciones

MOD.	FRAME	A*	B	C	E	F	G	HO-1-2-3	H4-5	H6-7	L	K	M*	N	P	R*	S	T
CASB 560/B	160 MB/2	870	525	445	390	400	179	670	400	670	214	196	808	440	400	345	30	690
CASB 560/A	160 L/2	950	525	445	390	400	179	670	400	670	214	196	808	440	400	345	30	690
CASB 560/A	100 LA/4	710	525	445	390	400	179	670	400	670	214	196	634	312	280	185	25	690
CASB 630/B	200 LA/2	1060	590	505	441	450	199	750	450	750	264	217	964	558	515	420	40	760
CASB 630/A	200 LB/2	1060	590	505	441	450	199	750	450	750	264	217	964	558	515	420	40	760
CASB 630/A	112 M/4	720	590	505	441	450	199	750	450	750	234	217	654	312	280	185	25	760

BOCA IMPULSIÓN

MOD.	U	V	n°	Ø	Ø'	d ¹	n°v	Øv	a	b	a ¹	b ¹	a ²	b ²	n°p	n°p	n°f	Øf	kg	WD ²
CASB 560/B	630	23	4+2	14	17	497	12	M8	453	322	497	366	533	402	2-125	3-125	14	12	275	3,5
CASB 560/A	630	23	4+2	14	17	497	12	M8	453	322	497	366	533	402	2-125	3-125	14	12	285	3,8
CASB 560/A	630	23	4+2	12	17	497	12	M8	453	322	497	366	533	402	2-125	3-125	14	12	140	3,7
CASB 630/B	700	23	4+2	19	17	551	12	M8	507	361	551	405	587	441	2-125	3-125	14	12	370	5,4
CASB 630/A	700	23	4+2	19	17	551	12	M8	507	361	551	405	587	441	2-125	3-125	14	12	400	5,9
CASB 630/A	700	23	4+2	12	17	551	12	M8	507	361	551	405	587	441	2-125	3-125	14	12	170	5,7

(*) Para construcciones a "ALTA TEMP." cotas "A-M-R" + 50 mm.
(kg) Peso ventilador con motor.
WD² = Momento de inercia del rodete, expresado en Kg x m²

Dimensiones mm

CASB 710...1400

SISTEMA
4

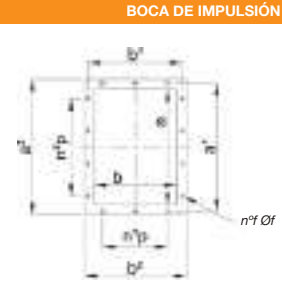
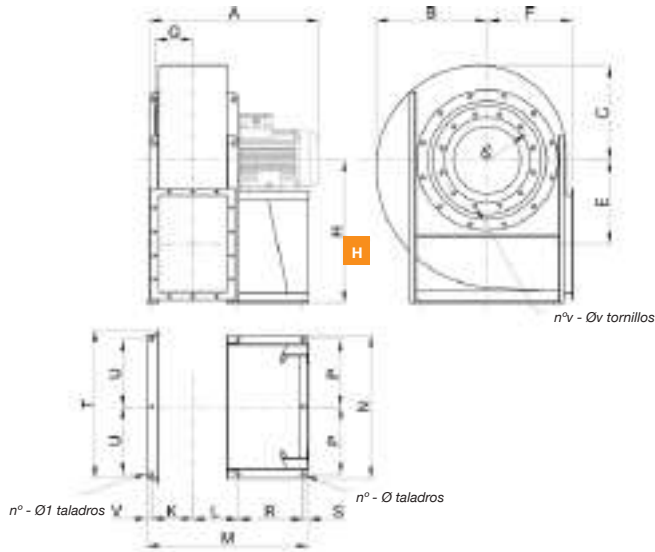

ORIENTACIONES

H0	H1	H2	H3	H4	H5	H6	H7
RD0	RD45	RD90	RD135	RD180	RD225	RD270	RD315
LG0	LG45	LG90	LG135	LG180	LG225	LG270	LG315

H * La medida de la cota H (distancia entre el suelo y el eje) varia según las orientaciones

MOD.	FRAME	A*	B	C	E	F	G	HO-1-2-3	H4-5	H6-7	L	K	M*	N	P	R*	S	T
CASB 710/B	132 S/4	890	670	570	500	500	221	670	500	850	251	243	793	831	385	230	40	920
CASB 710/A	132 MA/4	915	670	570	500	500	221	670	500	850	251	243	793	831	385	230	40	920
CASB 800/B	160 L/4	965	745	635	560	560	245	750	560	950	276	267	842	921	430	230	40	1000
CASB 800/A	160 L/4	1090	745	635	560	560	245	750	560	950	276	267	947	921	430	335	40	1000
CASB 800/A	132 MA/6	965	745	635	560	560	245	750	560	950	276	267	842	921	430	230	40	1000
CASB 900/B	180 M/4	1185	835	710	630	630	275	850	630	1060	303	297	1046	1021	480	380	40	1100
CASB 900/A	200 L/4	1245	835	710	630	630	275	850	630	1060	303	297	1116	1021	480	450	40	1100
CASB 900/A	160 M/6	1065	835	710	630	630	275	850	630	1060	303	297	1001	1021	480	335	40	1100
CASB 1000/B	225 S/4	1365	930	795	710	710	306	950	710	1180	334	323	1198	1120	530	450	50	1230
CASB 1000/A	225 M/4	1365	930	795	710	710	306	950	710	1180	334	323	1198	1120	530	450	50	1230
CASB 1000/B	160 L/6	1215	930	795	710	710	306	950	710	1180	334	323	1073	1120	530	325	50	1230
CASB 1000/A	180 L/6	1255	930	795	710	710	306	950	710	1180	334	323	1118	1120	530	370	50	1230
CASB 1120/B	250 M/4	1530	1045	895	800	800	340	1060	800	1320	398	365	1357	1260	590	490	50	1370
CASB 1120/A	280 S/4	1655	1045	895	800	800	340	1060	800	1320	398	365	1477	1260	590	610	50	1370
CASB 1120/B	200 LR/6	1405	1045	895	800	800	340	1060	800	1320	398	365	1277	1260	590	410	50	1370
CASB 1120/A	200 L/6	1405	1045	895	800	800	340	1060	800	1320	398	365	1277	1260	590	410	50	1370
CASB 1250/B	315 S/4	1750	1175	1005	900	900	385	1180	900	1500	437	403	1614	1390	650	670	50	1540
CASB 1250/A	315 MA/4	1750	1175	1005	900	900	385	1180	900	1500	437	403	1614	1390	650	670	50	1540
CASB 1250/B	225 M/6	1530	1175	1005	900	900	385	1180	900	1500	437	403	1364	1390	650	420	50	1540
CASB 1250/A	250 M/6	1605	1175	1005	900	900	385	1180	900	1500	437	403	1434	1390	650	490	50	1540
CASB 1400/B	280 S/6	1815	1305	1115	1000	1000	430	1320	1000	1700	500	446	1640	1530	725	580	60	1690
CASB 1400/A	315 S/6	1835	1305	1115	1000	1000	430	1320	1000	1700	500	446	1700	1530	725	640	60	1690

BOCA IMPULSIÓN																				
MOD.	U	V	n°	Ø	Ø'	d'	n°v	Øv	a	b	a'	b'	a²	b²	n°p	n°p'	n°f	øf	kg	WD²
CASB 710/B	385	29	5+3	19	19	629	12	M8	569	404	629	464	669	504	2-160	3-160	14	14	270	10,1
CASB 710/A	385	29	5+3	19	19	629	12	M8	569	404	629	464	669	504	2-160	3-160	14	14	280	11
CASB 800/B	430	29	5+3	19	19	698	12	M10	638	453	698	513	738	553	2-160	3-160	14	14	330	17,2
CASB 800/A	430	29	5+3	19	19	698	12	M10	638	453	698	513	738	553	2-160	3-160	14	14	405	19,1
CASB 800/A	430	29	5+3	19	19	698	12	M10	638	453	698	513	738	553	2-160	3-160	14	14	330	18,6
CASB 900/B	480	26	5+3	19	19	775	16	M10	715	507	775	567	815	607	2-160	4-160	16	14	420	33
CASB 900/A	480	26	5+3	19	19	775	16	M10	715	507	775	567	815	607	2-160	4-160	16	14	660	36
CASB 900/A	480	26	5+3	19	19	775	16	M10	715	507	775	567	815	607	2-160	4-160	16	14	490	35,5
CASB 1000/B	530	41	5+3	19	19	861	16	M10	801	569	871	639	921	689	2-200	3-200	14	14	750	70
CASB 1000/A	530	41	5+3	19	19	861	16	M10	801	569	871	639	921	689	2-200	3-200	14	14	765	76
CASB 1000/B	530	41	5+3	19	19	861	16	M10	801	569	871	639	921	689	2-200	3-200	14	14	620	65
CASB 1000/A	530	41	5+3	19	19	861	16	M10	801	569	871	639	921	689	2-200	3-200	14	14	640	70
CASB 1120/B	590	54	5+3	24	24	958	16	M10	898	638	968	708	1018	758	3-200	4-200	18	14	1150	89
CASB 1120/A	590	54	5+3	24	24	958	16	M10	898	638	968	708	1018	758	3-200	4-200	18	14	1200	95
CASB 1120/B	590	54	5+3	24	24	958	16	M10	898	638	968	708	1018	758	3-200	4-200	18	14	960	84
CASB 1120/A	590	54	5+3	24	24	958	16	M10	898	638	968	708	1018	758	3-200	4-200	18	14	990	89
CASB 1250/B	655	54	5+3	24	24	1067	24	M10	1007	715	1077	785	1127	835	3-200	4-200	18	14	1480	148
CASB 1250/A	655	54	5+3	24	24	1067	24	M10	1007	715	1077	785	1127	835	3-200	4-200	18	14	1550	170
CASB 1250/B	655	54	5+3	24	24	1067	24	M10	1007	715	1077	785	1127	835	3-200	4-200	18	14	1200	138
CASB 1250/A	655	54	5+3	24	24	1067	24	M10	1007	715	1077	785	1127	835	3-200	4-200	18	14	1330	160
CASB 1400/B	725	54	5+3	24	24	1200	24	M10	1130	801	1210	881	1270	941	3-200	5-200	20	18	1850	255
CASB 1400/A	725	54	5+3	24	24	1200	24	M10	1130	801	1210	881	1270	941	3-200	5-200	20	18	1950	268

(*) Para construcciones a "ALTA TEMP." cotas "A-M-R" + 50 mm.
(kg) Peso ventilador con motor.
WD² = Momento de inercia del rodete, expresado en Kg x m²

LARGE SERIES

Dimensiones mm

CASB-X 250...500

SISTEMA 1

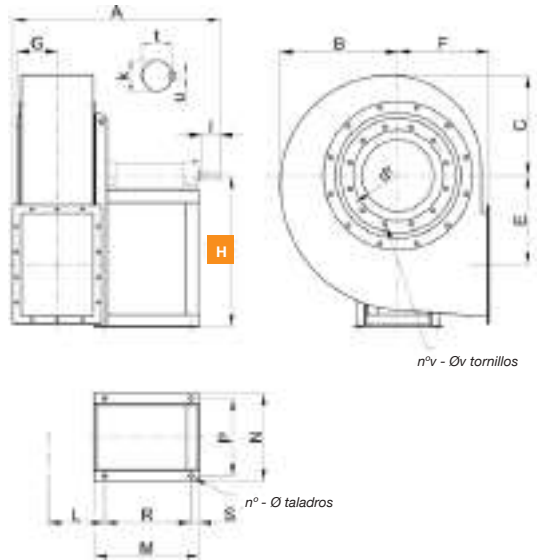

SISTEMA 12

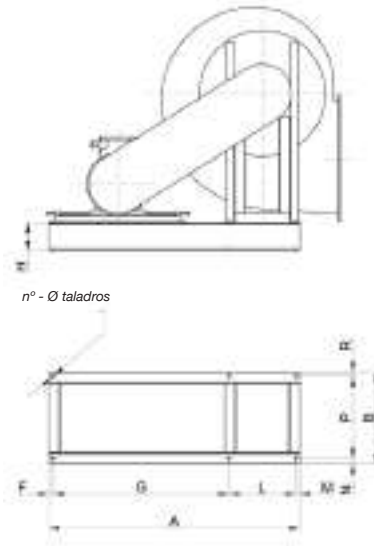

MOD.	A*	B	C	E	F	G	H0	H1	H2	H3
CASB 250	465	240	210	175	195	86	315	315	315	315
CASB 280	560	265	225	202	200	95	375	375	375	375
CASB 310	580	300	255	229	225	105	400	400	400	400
CASB 350	805	335	285	253	255	114	450	450	450	450
CASB 400	930	380	320	286	285	128	500	500	500	500
CASB 450	960	425	360	321	320	143	560	560	560	560
CASB 500	1000	470	405	355	360	158	600	600	600	600

MOD.	A	B*	H	F	G	L	M	N	P*
CASB 250	700	185	80	15	480	190	15	20	145
CASB 280	895	265	100	20	630	230	15	25	215
CASB 310	895	265	100	20	630	230	15	25	215
CASB 350	980	450	120	20	630	310	20	25	400
CASB 400	1020	530	120	20	650	330	20	25	480
CASB 450	1175	530	120	25	800	330	20	25	480
CASB 500	1265	495	160	25	830	385	25	30	430

MOD.	H4	H5	H6	H7	L	M*	N	P	R*	S
CASB 250	195	195	315	315	126	220	214	190	145	25
CASB 280	200	200	375	375	135	290	254	230	215	25
CASB 310	225	225	400	400	144	290	254	230	215	25
CASB 350	255	255	450	450	155	480	350	310	400	30
CASB 400	285	285	500	500	168	560	370	330	480	30
CASB 450	320	320	560	560	182	560	370	330	480	30
CASB 500	360	360	600	600	198	520	438	385	430	40

MOD.	R	N°	Φ	kg
CASB 250	20	6	10	19
CASB 280	25	6	12	30
CASB 310	25	6	12	30
CASB 350	25	6	14	45
CASB 400	25	6	14	50
CASB 450	25	6	14	55
CASB 500	35	6	17	78

MOD.	n°	Φ	k	l	t	u	d ¹	n°v	Φv	kg	WD ²
CASB 250	4	10	19k6	40	21,5	6	241	8	M6	25	0,1
CASB 280	4	12	24k6	50	27	8	265	8	M6	35	0,15
CASB 310	4	12	24k6	50	27	8	292	8	M8	40	0,25
CASB 350	4	14	28k6	60	31	8	332	8	M8	70	0,4
CASB 400	4	14	38k6	80	41	10	366	8	M8	80	0,75
CASB 450	4	14	38k6	80	41	10	405	8	M8	100	1,1
CASB 500	4	17	42k6	110	45	12	448	12	M8	140	2,2

(¹) Para construcciones a "ALTA TEMP." en mod. de 250 a 500, cotas "B-P" + 50 mm.
Kg = Peso de la base soporte

(¹) Para construcciones a "ALTA TEMP." en mod. de 250 a 500, cotas "A-M-R" + 50 mm.
(kg) Peso ventilador sin motor.
WD² = Momento de inercia del rodete, expresado en Kg x m²

BOCA DE IMPULSIÓN

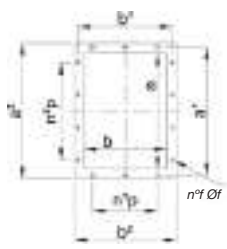

BOCA IMPULSIÓN

MOD.	a	b	a ¹	b ¹	a ²	b ²	n°p	n°v	n°f	Φf
CASB 250	205	146	241	182	275	216	1-112	1-112	8	12
CASB 280	229	164	265	200	299	234	1-112	1-112	8	12
CASB 310	256	183	292	219	326	253	1-112	2-112	10	12
CASB 350	288	205	332	249	368	285	1-125	2-125	10	12
CASB 400	322	229	366	273	402	309	1-125	2-125	10	12
CASB 450	361	256	405	300	441	336	1-125	2-125	10	12
CASB 500	404	288	448	332	484	368	2-125	3-125	14	12

ORIENTACIONES

H0	H1	H2	H3	H4	H5	H6	H7
RD0	RD45	RD90	RD135	RD180	RD225	RD270	RD315
LG0	LG45	LG90	LG135	LG180	LG225	LG270	LG315

H * La medida de la cota H (distancia entre el suelo y el eje) varía según las orientaciones

LARGE SERIES

Dimensiones mm

CASB-X 560...630

SISTEMA
1

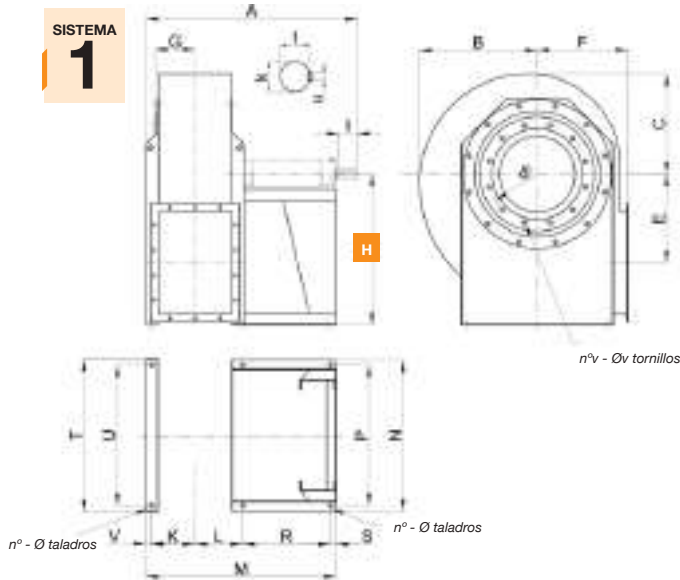

SISTEMA
12

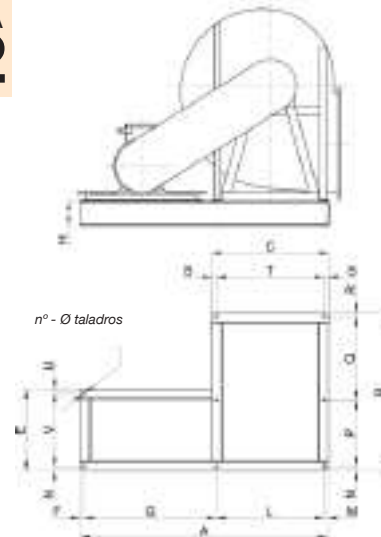

MOD.	A*	B	C	E	F	G	H0	H1	H2
CASB 560	1055	525	445	390	400	179	670	670	670
CASB 630	1095	590	505	441	450	199	750	750	750

MOD.	A	B*	C	E	H	F	G	L	M	N	P*
CASB 560	1415	893	690	510	160	25	735	630	25	30	430
CASB 630	1610	933	760	530	160	25	860	700	25	30	430

MOD.	H3	H4	H5	H6	H7	L	K	M*	N
CASB 560	670	400	400	670	670	214	196	903	683
CASB 630	750	450	450	750	750	233	217	943	753

MOD.	Q	R	S	T	U	V	N°	Φ	kg
CASB 560	410	23	30	630	25	455	8	17	105
CASB 630	450	23	30	700	25	475	8	17	115

MOD.	P	R*	S	T	U	V	n°	Φ	k
CASB 560	630	430	40	690	630	23	4+2	17	48k6
CASB 630	700	430	40	760	700	23	4+2	17	48k6

MOD.	l	t	u	d'	n°v	Φv	kg	WD²
CASB 560	110	51,5	14	497	12	M8	170	3,8
CASB 630	110	51,5	14	551	12	M8	200	5,6

(*) Para construcciones a "ALTA TEMP." en mod. de 560 a 630, cotas "A-M-R" + 50 mm.
(kg) Peso ventilador sin motor.
WD² = Momento de inercia del rodete, expresado en Kg x m²

(*) Para construcciones a "ALTA TEMP." en mod. de 560 a 630, cotas "B-P" + 50 mm.
Kg = Peso de la base soporte

BOCA DE IMPULSIÓN

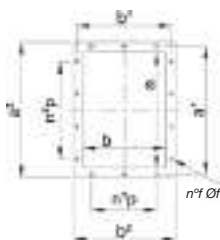

BOCA IMPULSIÓN

MOD.	a	b	a'	b'	a''	b''	n°p	n°p'	n°f	Φf
CASB 560	453	322	497	366	533	402	2-125	3-125	14	12
CASB 630	507	361	551	405	587	441	2-125	3-125	14	12

ORIENTACIONES

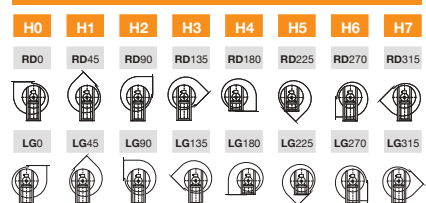

H * La medida de la cota H (distancia entre el suelo y el eje) varía según las orientaciones

Dimensiones mm

CASB-X 710...2000

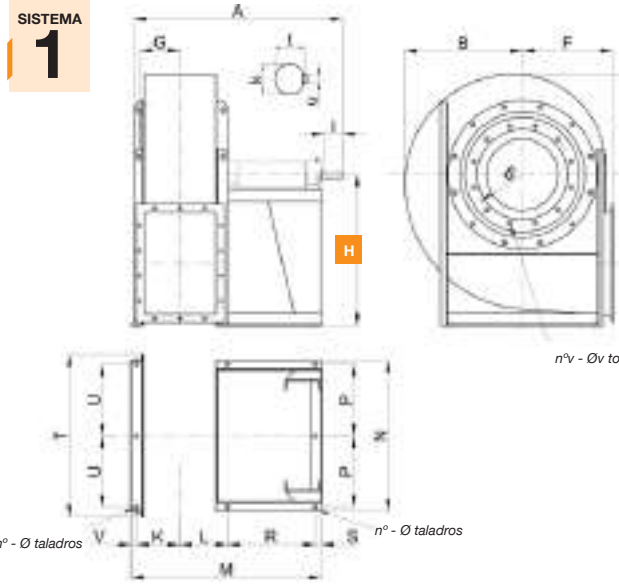

SISTEMA 12

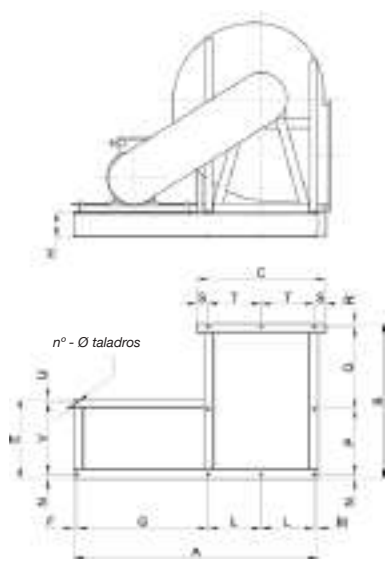

MOD.	A*	B	C	E	F	G	H0	H1	H2	H3
CASB 710	1235	670	570	500	500	221	670	670	670	670
CASB 800	1335	745	635	560	560	245	750	750	750	750
CASB 900	1390	835	710	630	630	275	850	850	850	850
CASB 1000	1545	930	795	710	710	306	950	950	950	950
CASB 1120	1820	1045	895	800	800	340	1060	1060	1060	1060
CASB 1250	1895	1175	1005	900	900	385	1180	1180	1180	1180
CASB 1400	2060	1305	1115	1000	1000	430	1320	1320	1120	1120
CASB 1600	2350	1535	1245	1120	1120	480	1500	1500	1250	1250
CASB 1800	2530	1705	1390	1250	1250	515	1650	1550	1400	1320
CASB 2000	2650	1920	1555	1400	1400	575	1850	1700	1600	1450

MOD.	H4	H5	H6	H7	L	K	M*	N	P	R*
CASB 710	500	500	850	850	251	243	1078	831	385	515
CASB 800	560	560	950	950	276	267	1177	921	430	565
CASB 900	630	630	1060	1060	303	297	1231	1021	480	565
CASB 1000	710	710	1180	1180	334	323	1353	1120	530	605
CASB 1120	800	800	1320	1320	398	365	1627	1260	590	760
CASB 1250	900	900	1500	1500	437	403	1704	1390	655	760
CASB 1400	1000	1000	1700	1500	500	446	1840	1530	725	780
CASB 1600	1120	1120	1900	1600	568	505	2117	1720	820	920
CASB 1800	1250	1250	2120	1800	623	569	2226	1910	915	920
CASB 2000	1400	1400	2360	2000	684	631	2379	2110	1015	920

MOD.	S	T	U	V	n°	Φ	k	l	t	u
CASB 710	40	920	385	29	5+3	19	48k6	110	51,5	14
CASB 800	40	1000	430	29	5+3	19	55m6	110	59	16
CASB 900	40	1100	480	26	5+3	19	55m6	110	59	16
CASB 1000	50	1230	530	41	5+3	19	65 m6	140	69	18
CASB 1120	50	1370	590	54	5+3	24	75m6	140	79,5	20
CASB 1250	50	1540	655	54	5+3	24	75m6	140	79,5	20
CASB 1400	60	1690	725	54	5+3	24	80m6	170	85	22
CASB 1600	60	1950	820	64	5+3	28	90m6	170	95	25
CASB 1800	60	2150	915	54	5+3	28	100j6	210	106	28
CASB 2000	60	2390	1015	84	5+3	28	100j6	210	106	28

MOD.	d ¹	n°v	Φv	kg	WD ²
CASB 710	629	12	M8	280	11,3
CASB 800	698	12	M8	350	19,1
CASB 900	775	16	M10	400	36
CASB 1000	861	16	M10	520	72
CASB 1120	958	16	M10	850	91
CASB 1250	1067	24	M10	1050	160
CASB 1400	1200	24	M10	1500	264
CASB 1600	1337	24	M10	1950	476
CASB 1800	1491	32	M10	2800	800
CASB 2000	1663	32	M12	3500	1250

(*) Para construcciones a "ALTA TEMP." en mod. de 710 a 900, cotas "A-M-R" + 50 mm.
 (kg) Peso ventilador sin motor.
 WD² = Momento de inercia del rodete, expresado en Kg x m²

MOD.	A	B*	C	E	H	F	G	L	M	N	P*	Q
CASB 710	1980	1072	920	690	180	30	1150	385	30	30	515	497
CASB 800	2070	1166	1000	690	180	30	1150	430	30	30	565	543
CASB 900	2200	1224	1100	750	180	30	1180	480	30	30	565	600
CASB 1000	2300	1329	1230	755	180	30	1180	530	30	35	605	657
CASB 1120	2470	1592	1370	830	180	35	1220	590	35	35	760	763
CASB 1250	2600	1667	1540	830	180	35	1220	655	35	35	760	840
CASB 1400	3150	1794	1690	990	180	35	1630	725	35	35	780	946
CASB 1600	3340	2063	1950	990	180	35	1630	820	35	35	920	1073
CASB 1800	3600	2185	2150	1100	180	35	1700	915	35	35	920	1192
CASB 2000	3800	2309	2390	1100	180	35	1700	1015	35	35	920	1315

MOD.	R	S	T	U	V	N°	Φ	kg
CASB 710	30	75	385	30	630	10	19	167
CASB 800	28	70	430	30	630	10	19	175
CASB 900	29	70	480	30	690	10	19	190
CASB 1000	32	85	530	30	690	10	19	200
CASB 1120	34	95	590	35	760	10	24	295
CASB 1250	32	115	655	35	760	10	24	310
CASB 1400	33	120	725	35	920	10	24	365
CASB 1600	35	155	820	35	920	10	28	390
CASB 1800	38	160	915	35	1030	10	28	475
CASB 2000	39	180	1015	35	1030	10	28	500

(*) Para construcciones a "ALTA TEMP." en mod. de 710 a 900, cotas "B-P" + 50 mm.
 Kg = Peso de la base soporte

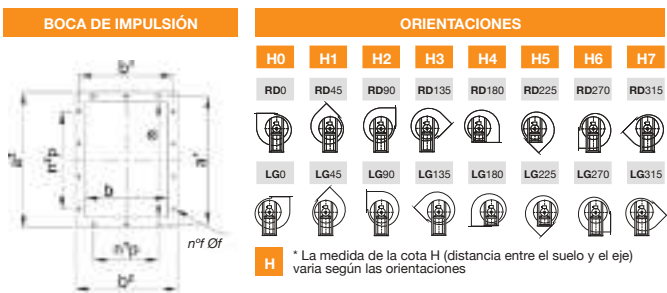

MOD.	a	b	a ¹	b ¹	a ²	b ²	n°p	n°p	n°f	Φf
CASB 710	569	404	629	464	669	504	2-160	3-160	14	14
CASB 800	638	453	698	513	738	553	2-160	3-160	14	14
CASB 900	715	507	775	567	815	607	2-160	4-160	16	14
CASB 1000	801	569	871	639	921	689	2-200	3-200	14	14
CASB 1120	898	638	968	708	1018	758	3-200	4-200	18	14
CASB 1250	1007	715	1077	785	1127	835	3-200	4-200	18	14
CASB 1400	1130	801	1210	881	1270	941	3-200	5-200	20	18
CASB 1600	1267	898	1347	978	1407	1038	4-200	6-200	24	18
CASB 1800	1421	1007	1501	1087	1561	1147	4-200	6-200	24	18
CASB 2000	1593	1130	1683	1220	1753	1290	5-200	7-200	28	22

LARGE SERIES

Accesorios

Contrabrida aspiración

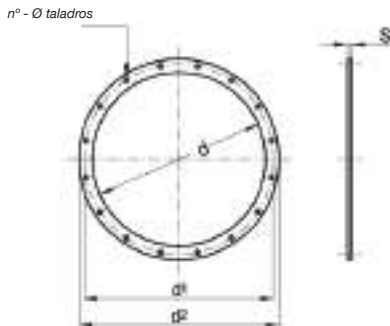

MOD.	d	d'	d'	n°	Φ	s	kg
CASB 250	205	241	275	8	9	4	0,75
CASB 280	229	265	299	8	9	4	0,8
CASB 310	255	292	325	8	11	4	1
CASB 350	286	332	366	8	11	5	1,6
CASB 400	321	366	401	8	11	5	1,8
CASB 450	361	405	441	8	11	5	2
CASB 500	406	448	486	12	11	5	2,2
CASB 560	456	497	536	12	11	5	2,5
CASB 630	506	551	586	12	11	5	2,7
CASB 710	568	629	668	12	11	6	4,6
CASB 800	638	698	738	12	11	6	5
CASB 900	718	775	818	16	13	6	5,5
CASB 1000	808	861	908	16	13	6	6,2
CASB 1120	908	958	1008	16	13	6	7
CASB 1250	1008	1067	1108	24	13	6	7,8
CASB 1400	1130	1200	1250	24	13	8	14
CASB 1600	1260	1337	1380	24	13	8	15,5
CASB 1800	1410	1491	1530	32	13	8	17
CASB 2000	1610	1663	1730	32	15	8	19,5

Contrabrida impulsión

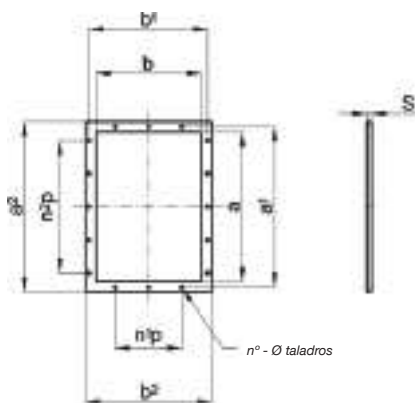

MOD.	a	b	a'	b'	a²	b²	n°p	n²p	n°	Φ	s	kg
CASB 250	205	146	241	182	275	216	1-112	1-112	8	12	4	0,9
CASB 280	229	164	265	200	299	234	1-112	1-112	8	12	4	1
CASB 310	256	183	292	219	326	253	1-112	2-112	10	12	4	1,1
CASB 350	288	205	332	249	368	285	1-125	2-125	10	12	5	1,8
CASB 400	322	229	366	273	402	309	1-125	2-125	10	12	5	2
CASB 450	361	256	405	300	441	336	1-125	2-125	10	12	5	2,2
CASB 500	404	288	448	332	484	368	2-125	3-125	14	12	5	2,4
CASB 560	453	322	497	366	533	402	2-125	3-125	14	12	5	2,7
CASB 630	507	361	551	405	587	441	2-125	3-125	14	12	5	3
CASB 710	569	404	629	464	669	504	2-160	3-160	14	14	6	5
CASB 800	638	453	698	513	738	553	2-160	3-160	14	14	6	5,6
CASB 900	715	507	775	567	815	607	2-160	4-160	16	14	8	6,2
CASB 1000	801	569	871	639	921	689	2-200	3-200	14	14	8	11,2
CASB 1120	898	638	968	708	1018	758	3-200	4-200	18	14	8	12,5
CASB 1250	1007	715	1077	785	1127	835	3-200	4-200	18	14	8	14
CASB 1400	1130	801	1210	881	1270	941	3-200	5-200	20	18	8	18
CASB 1600	1267	898	1347	978	1407	1038	4-200	6-200	24	18	8	20
CASB 1800	1421	1007	1501	1087	1561	1147	4-200	6-200	24	18	8	22,3
CASB 2000	1593	1130	1683	1220	1753	1290	5-200	7-200	28	22	8	28,5

Red protección en aspiración

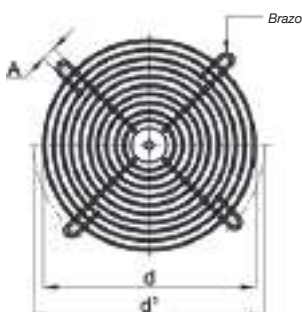

MOD.	d	d'	A	n°	kg
CASB 250	205	241	9	4	0,2
CASB 280	229	265	9	4	0,25
CASB 310	255	292	11	4	0,3
CASB 350	286	332	11	4	0,35
CASB 400	321	366	11	4	0,4
CASB 450	361	405	11	8	0,7
CASB 500	406	448	11	8	0,8
CASB 560	456	497	11	8	0,9
CASB 630	506	551	11	8	1
CASB 710	568	629	11	8	1,2
CASB 800	638	698	11	8	1,5
CASB 900	718	775	13	8	2
CASB 1000	808	861	13	8	2,5
CASB 1120	908	958	13	8	3
CASB 1250	1008	1067	13	8	3,5
CASB 1400	1130	1200	13	8	4
CASB 1600	1260	1337	13	8	4,5
CASB 1800	1410	1491	13	8	5
CASB 2000	1610	1663	15	8	5,5

Accesorios

Junta anti vibratoria en aspiración

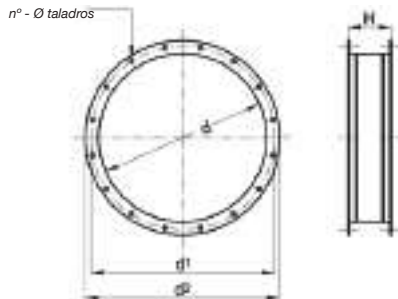

MOD.	d	d'	d''	n°	Φ	H	kg
CASB 250	205	241	275	8	9	200	1,8
CASB 280	229	265	299	8	9	200	2
CASB 310	255	292	325	8	11	200	2,2
CASB 350	286	332	366	8	11	200	3,4
CASB 400	321	366	401	8	11	200	3,8
CASB 450	361	405	441	8	11	200	4,2
CASB 500	406	448	486	12	11	200	4,6
CASB 560	456	497	536	12	11	200	5,1
CASB 630	506	551	586	12	11	200	5,6
CASB 710	568	629	668	12	11	200	9,4
CASB 800	638	698	738	12	11	200	10,4
CASB 900	718	775	818	16	13	200	11,6
CASB 1000	808	861	908	16	13	200	13
CASB 1120	908	958	1008	16	13	200	14,4
CASB 1250	1008	1067	1108	24	13	200	16
CASB 1400	1130	1200	1250	24	13	200	28,5
CASB 1600	1260	1337	1380	24	13	200	31,5
CASB 1800	1410	1491	1530	32	13	200	34,5
CASB 2000	1610	1663	1730	32	15	200	39,5

Junta anti vibratoria en impulsión

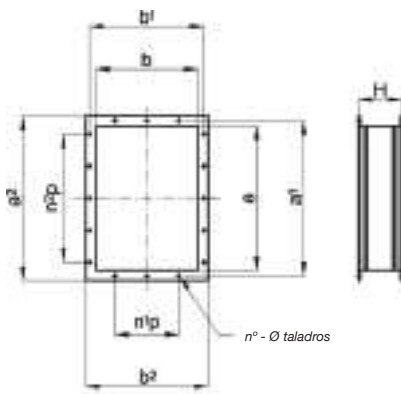

MOD.	a	b	a'	b'	a''	b''	n°p	n°p'	n°	Φ	H	kg
CASB 250	205	146	241	182	275	216	1-112	1-112	8	12	200	2
CASB 280	229	164	265	200	299	234	1-112	1-112	8	12	200	2,2
CASB 310	256	183	292	219	326	253	1-112	2-112	10	12	200	2,4
CASB 350	288	205	332	249	368	285	1-125	2-125	10	12	200	3,8
CASB 400	322	229	366	273	402	309	1-125	2-125	10	12	200	4,2
CASB 450	361	256	405	300	441	336	1-125	2-125	10	12	200	4,6
CASB 500	404	288	448	332	484	368	2-125	3-125	14	12	200	5
CASB 560	453	322	497	366	533	402	2-125	3-125	14	12	200	5,6
CASB 630	507	361	551	401	587	441	2-125	3-125	14	12	200	6,2
CASB 710	569	404	629	464	669	504	2-160	3-160	14	14	200	10,2
CASB 800	638	453	698	513	738	553	2-160	3-160	14	14	200	11,4
CASB 900	715	507	775	567	815	607	2-160	4-160	16	14	200	12,6
CASB 1000	801	569	871	639	921	689	2-200	3-200	14	14	200	23
CASB 1120	898	638	968	708	1018	758	3-200	4-200	18	14	200	25,5
CASB 1250	1007	715	1077	785	1127	835	3-200	4-200	18	14	200	28,5
CASB 1400	1130	801	1210	881	1270	941	3-200	5-200	20	18	200	37
CASB 1600	1267	898	1347	978	1407	1038	4-200	6-200	24	18	200	41
CASB 1800	1421	1007	1501	1087	1561	1147	4-200	6-200	24	18	200	45,5
CASB 2000	1593	1130	1683	1220	1753	1290	5-200	7-200	28	22	200	58

Regulador de caudal en aspiración

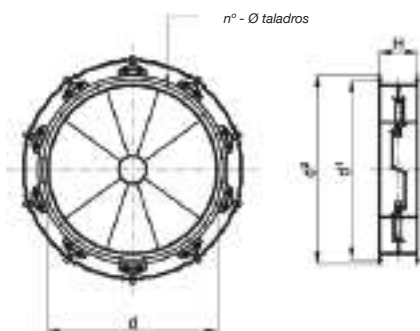

MOD.	d	d'	d''	n°	Φ	H	kg
CASB 400	321	366	401	8	11	200	24
CASB 450	361	405	441	8	11	250	26
CASB 500	406	448	486	12	11	250	30
CASB 560	456	497	536	12	11	250	32
CASB 630	506	551	586	12	11	250	45
CASB 710	568	629	668	12	11	250	50
CASB 800	638	698	738	12	11	300	58
CASB 900	718	775	818	16	13	300	68
CASB 1000	808	861	908	16	13	350	87
CASB 1120	908	958	1008	16	13	350	102
CASB 1250	1008	1067	1108	24	13	350	120
CASB 1400	1130	1200	1250	24	13	400	150
CASB 1600	1260	1337	1380	24	13	400	170
CASB 1800	1410	1491	1530	32	13	400	190
CASB 2000	1610	1663	1730	32	15	450	220

LARGE SERIES

Accesorios

Dámper de aletas contrapuestas

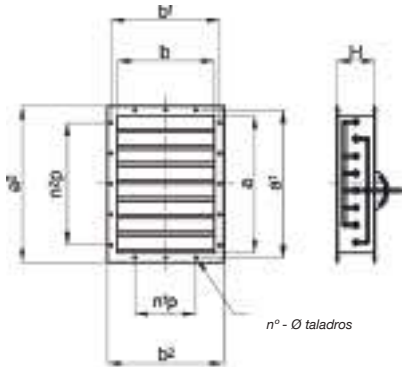

MOD.	a	b	a'	b'	a''	b''	n°p	n°p	n°	Φ	H (1)	H (2)	kg (1)	kg (2)
CASB 400	322	229	366	273	402	309	1-125	2-125	10	12	220	250	11	12
CASB 450	361	256	405	300	441	336	1-125	2-125	10	12	220	250	14	15
CASB 500	404	288	448	332	484	368	2-125	3-125	14	12	220	250	18	19
CASB 560	453	322	497	366	533	402	2-125	3-125	14	12	220	250	21	22
CASB 630	507	361	551	405	587	441	2-125	3-125	14	12	220	250	24	25
CASB 710	569	404	629	464	669	504	2-160	3-160	14	14	220	250	28	29
CASB 800	638	453	698	513	738	553	2-160	3-160	14	14	220	250	32	33
CASB 900	715	507	775	567	815	607	2-160	4-160	16	14	220	250	36	38
CASB 1000	801	569	871	639	921	689	2-200	3-200	14	14	220	250	44	46
CASB 1120	898	638	968	708	1018	758	3-200	4-200	18	14	220	250	50	52
CASB 1250	1007	715	1077	785	1127	835	3-200	4-200	18	14	220	250	55	58
CASB 1400	1130	801	1210	881	1270	941	3-200	5-200	20	18	220	250	81	84
CASB 1600	1267	898	1347	978	1407	1038	4-200	6-200	24	18	220	250	92	96
CASB 1800	1421	1007	1501	1087	1561	1147	4-200	6-200	24	18	220	250	105	110
CASB 2000	1593	1130	1683	1220	1753	1290	5-200	7-200	28	22	220	250	140	145

(1) Hasta 300 mm H₂O
(2) A partir de 300 mm H₂O

Amortiguadores

TIPO 1

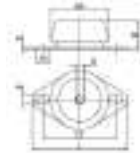

TIPO 2

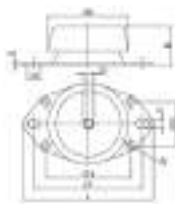

TIPO 3

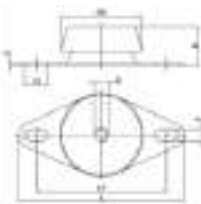

MOD.	MODELO AMORTIGUADORES	TIPO	øA	B	D	CF	CF1	CF2	F	øF1	L	M	S
CASB-250	CF 623110	1	67	33...34	10	76,5	-	-	9	-	90,5	16	2
CASB-280	CF 623110	1	67	33...34	10	76,5	-	-	9	-	90,5	16	2
CASB-310	CF 623110	1	67	33...34	10	76,5	-	-	9	-	90,5	16	2
CASB-350	CF 623110	1	67	33...34	10	76,5	-	-	9	-	90,5	16	2
CASB-400	CF 623110	1	67	33...34	10	76,5	-	-	9	-	90,5	16	2
CASB-450	CF 623110	1	67	33...34	10	76,5	-	-	9	-	90,5	16	2
CASB-500	CF 623110	1	67	33...34	10	76,5	-	-	9	-	90,5	16	2
CASB-560	CF 623110	1	67	33...34	10	76,5	-	-	9	-	90,5	16	2
CASB-630	CF 623110	1	67	33...34	10	76,5	-	-	9	-	90,5	16	2
CASB-710	CF 623110	1	67	33...34	10	76,5	-	-	9	-	90,5	16	2
CASB-800	CF 924512	2	92	44...45	12	120	98	50	10,5	8,5	130	15,5	2,5
CASB-900	CF 924512	2	92	44...45	12	120	98	50	10,5	8,5	130	15,5	2,5
CASB-1000	CF 924512	2	92	44...45	12	120	98	50	10,5	8,5	130	15,5	2,5
CASB-1120	CF 924512	2	92	44...45	12	120	98	50	10,5	8,5	130	15,5	2,5
CASB-1250	CF 924512	2	92	44...45	12	120	98	50	10,5	8,5	130	15,5	2,5
CASB-1400	CF 924512	2	92	44...45	12	120	98	50	10,5	8,5	130	15,5	2,5
CASB-1600	CF 1204516	3	92	45	26,5	149,5			14		190	16	3,5
CASB-1800	CF 1204516	3	92	45	26,5	149,5			14		190	16	3,5
CASB-2000	CF 1204516	3	92	45	26,5	149,5			14		190	16	3,5

Silenciadores circulares

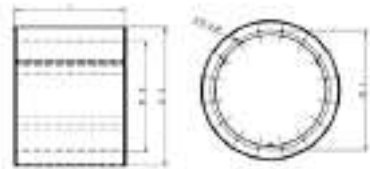

Los silenciadores se utilizan para bajar el nivel sonoro en instalaciones de acondicionamiento o ventilación, fabricados en acero cincado

- Bajo demanda: otras construcciones en diferentes materiales.

øD	øE	L	øI	F	øM
315	515	ØD,1,5ØD, 2ØD	355	8	M8
355	555	ØD,1,5ØD, 2ØD	395	8	M8
400	600	ØD,1,5ØD, 2ØD	450	8	M8
450	650	ØD,1,5ØD, 2ØD	500	8	M8
500	700	ØD,1,5ØD, 2ØD	560	12	M8
560	760	ØD,1,5ØD, 2ØD	620	12	M8
630	830	ØD,1,5ØD, 2ØD	690	12	M8
710	910	ØD,1,5ØD, 2ØD	770	16	M8
800	1000	ØD,1,5ØD, 2ØD	860	16	M8

øD	øE	L	øI	F	øM
900	1100	ØD,1,5ØD, 2ØD	970	16	M10
1000	1200	ØD,1,5ØD, 2ØD	1070	16	M10
1120	1320	ØD,1,5ØD, 2ØD	1190	20	M10
1250	1450	ØD,1,5ØD, 2ØD	1320	20	M10
1400	1600	ØD,1,5ØD, 2ØD	1470	20	M10
1500	1700	ØD,1,5ØD, 2ØD	1570	20	M10
1600	1800	ØD,1,5ØD, 2ØD	1680	24	M14
1700	1900	ØD,1,5ØD, 2ØD	1780	24	M14
1800	2000	ØD,1,5ØD, 2ØD	1880	24	M14

MOTOR DIRECTO

CAAB

Ventiladores centrífugos de alta presión y simple aspiración de gran robustez con envolvente y turbina en chapa de acero

Diseñados para aire limpio y polvoriento



* Las imágenes son solo a nivel ilustrativo, el producto puede variar en función del tamaño, especificaciones y posición.

Ventilador:

- Envolvente en chapa de acero.
- Turbina a reacción en chapa de acero de gran robustez, especialmente diseñados para aire limpio y polvoriento.
- Motor directamente acoplado.
- Con trampilla de inspección y limpieza a partir del tamaño 560.
- Todas las carcasas soldadas en continuo.

Motor:

- Motores con eficiencia IE3 para potencias iguales o superiores a 0,75 kW, excepto monofásicos, 2 velocidades y 8 polos.
- Motores clase F con rodamientos a bolas. Protección IP55.
- Trifásicos 230/400 V 50 Hz (hasta 4 kW) y 400/690 V 50 Hz (potencias superiores a 4 kW).
- Temperatura máxima del aire a transportar: -25 °C +90 °C.

Acabado:

- Anticorrosivo en resina de poliéster polimerizada a 190 °C, previo desengrase con tratamiento nanotecnológico libre de fosfatos.

Bajo demanda:

- Bobinados especiales para diferentes tensiones.
- Ventilador preparado para transportar aire hasta +150 °C.
- Ejecuciones especiales para temperaturas +300 °C.
- Ventilador en acero inoxidable.
- Certificación ATEX Categoría 2.
- Acoplamiento elástico sistema 8.

Código de pedido

CAAB — 450 — 2T — 10

CAAB: Ventiladores centrífugos de alta presión y simple aspiración de gran robustez con envolvente y turbina en chapa de acero

Tamaño turbina

Número de polos motor
2=2900 r/min 50 Hz
4=1400 r/min 50 Hz
6=900 r/min 50 Hz

T=Trifásico

Potencia motor (CV)

Formas constructivas motor directo

SISTEMA 4

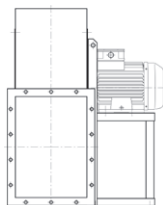

Accionamiento directo, turbina montada en el eje motor, montado sobre la silleta.

SISTEMA 5

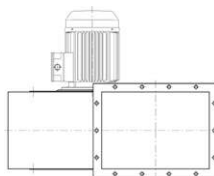

Accionamiento directo, turbina montada en el eje motor, motor de brida montado sobre la carcasa del ventilador.

SISTEMA 8

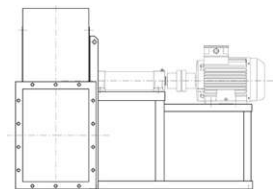

Accionamiento por acoplamiento elástico, turbina montada en el eje soporte, montado al motor mediante acoplamiento elástico. Todo montado conjuntamente sobre la silleta ventilador.

Orientaciones

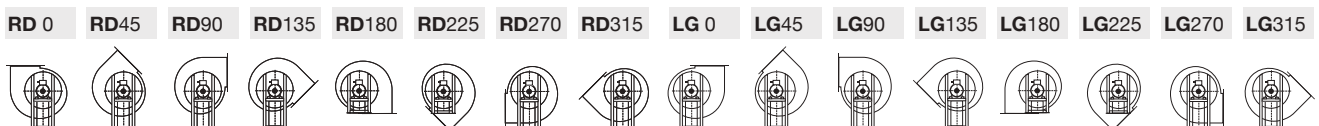

Suministro estándar LG270, otras posiciones bajo demanda. Modelos del 350 al 710 orientables. Medidas especiales en posiciones 180 y 225. Modelos del 800 al 900 orientables. Medidas especiales excepto posición 315. Modelos del 1000 al 1400 no orientables. Medidas especiales excepto posición 315.

LARGE SERIES

Características técnicas

Modelo	Frame	Velocidad (r/min)	Intensidad máx admisible (A)			Potencia instalada (kW)	Caudal máximo (m ³ /h)	Nivel Presión Sonora dB(A)	Peso aprox (Kg)	According ErP
			230 V	400 V	690 V					
CAAB-400-2T-3 IE3	90 L	2910	7,32	4,21		2,2	2880	84	55	2015
CAAB-450-2T-5.5 IE3	112 M	2900	13	7,5		4	3780	87	85	2015
CAAB-500-2T-5.5 IE3	112 M	2900	13	7,5		4	2880	87	100	2015
CAAB-500-2T-10 IE3	132 SB	2930		14,1	8,17	7,5	4680	90	120	2015
CAAB-560-2T-10 IE3	132 SB	2930		14,1	8,17	7,5	4680	90	140	2015
CAAB-560-2T-15 IE3	160 MA	2945		20	11,6	11	7560	93	175	2015
CAAB-630-2T-25 IE3	160 L	2945		33,9	19,7	18,5	10800	100	240	2015
CAAB-710-2T-30 IE3	180 M	2950		39,7	23	22	8280	100	280	2015
CAAB-710-2T-50 IE3	200 LB	2960		67,8	39,3	37	15480	100	410	2015
CAAB-800-2T-60 IE3	225 M	2960		77,5	44,9	45	15480	103	490	2015
CAAB-800-2T-100 IE3	280 S	2975		130	75,4	75	23400	102	670	2015
CAAB-900-2T-100 IE3	280 S	2975		130	75,4	75	19080	102	880	2015
CAAB-900-2T-150 IE3	315 S	2980		189	110	110	30600	104	1080	2015
CAAB-1000-2T-175 IE3	315 MA	2980		224	130	132	37800	108	1150	2015
CAAB-1000-2T-270 IE3	315 MC	2975		334	194	200	43200	108	1280	2015



Erp. (Energy Related Products)

Información de la Directiva 2009/125/EC descargable desde la web de SODECA o programa de selección QuickFan

Curvas Características

Q= Caudal en m³/h, m³/s y cfm

Pe= Presión estática en mmH₂O, Pa e inwg

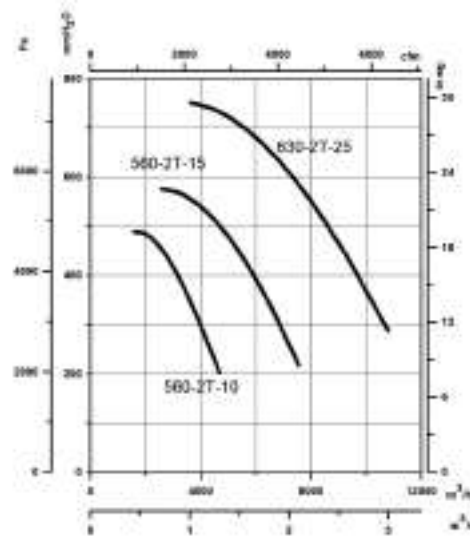
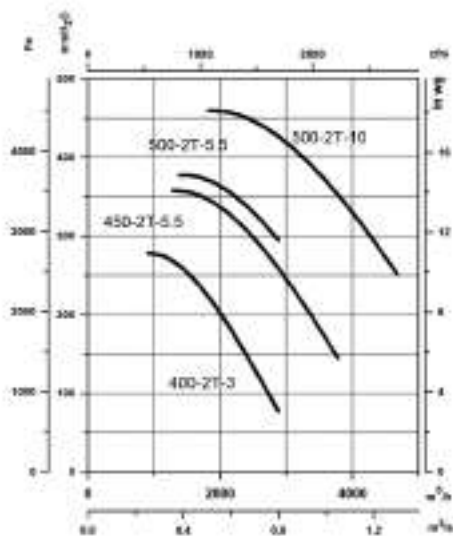

Curvas Características

Q= Caudal en m³/h, m³/s y cfm

Pe= Presión estática en mmH₂O, Pa e inwg

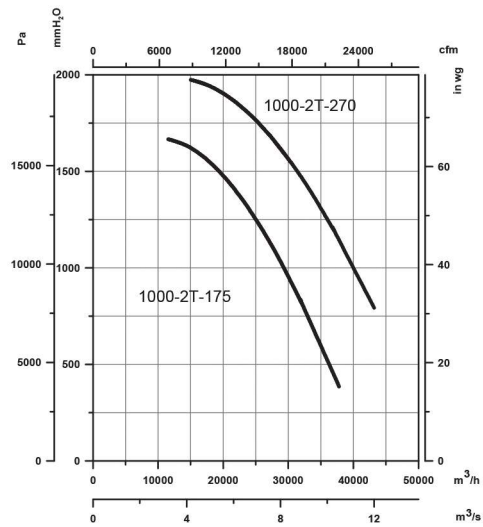
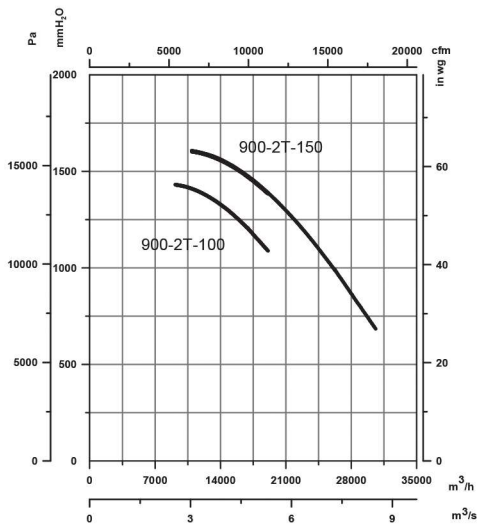
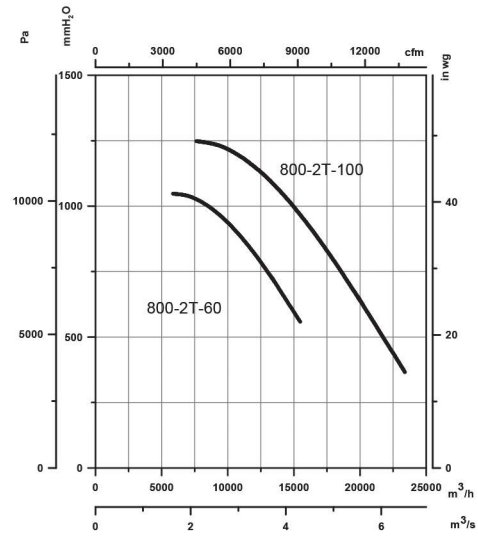
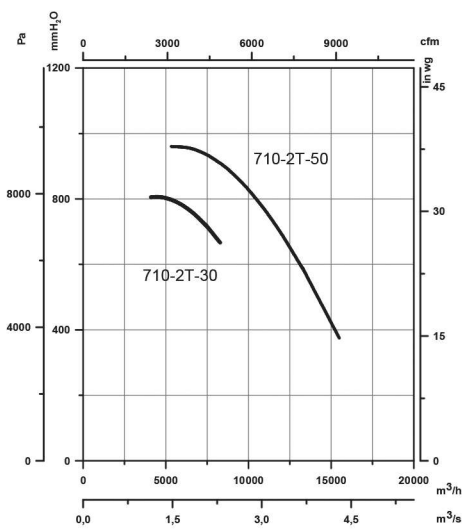

Accesorios

LARGE SERIES



MOTOR A TRANSMISIÓN

CAAB-X

Ventiladores de alta presión accionados a transmisión, equipados con motor eléctrico, conjunto de poleas, correas y protectores normalizados según norma ISO-13857

Diseñados para aire limpio y polvoriento



Motor:

- Motores con eficiencia IE3.
- Motores clase F con rodamientos a bolas. Protección IP55.
- Trifásicos 230/400 V 50 Hz (hasta 4 kW) y 400/690 V 50 Hz (potencias superiores a 4 kW).
- Temperatura máxima del aire a transportar: -25 °C +90 °C.

Acabado:

- Anticorrosivo en resina de poliéster polimerizada a 190 °C, previo desengrase con tratamiento nanotecnológico libre de fosfatos.

Bajo demanda:

- Bobinados especiales para diferentes tensiones.
- Ventilador preparado para transportar aire hasta +300 °C.
- Ventilador en acero inoxidable.
- Certificación ATEX Categoría 2.
- Acoplamiento elástico sistema 8.

Ventilador:

- Envoltente en chapa de acero.
- Turbina a reacción en chapa de acero de gran robustez, especialmente diseñados para aire limpio y polvoriento.
- Motor montado sobre bancada general.
- Con trampilla de inspección y limpieza a partir del tamaño 560.
- Todas las carcasas soldadas en continuo.

* Las imágenes son solo a nivel ilustrativo, el producto puede variar en función del tamaño, especificaciones y posición.

Formas constructivas motor a transmisión

SISTEMA 12

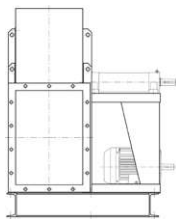

Accionamiento a transmisión, igual al SISTEMA 1, con el motor y ventilador montados en la bancada común. Posiciones de motor "W" o "Z" y excepcionalmente "X" o "Y".

SISTEMA 9

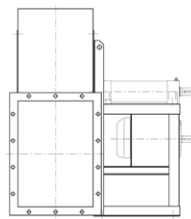

Accionamiento a transmisión, igual al SISTEMA 1, con el motor montado en el lateral de la silleta, en posición "W" o "Z".

SISTEMA 1

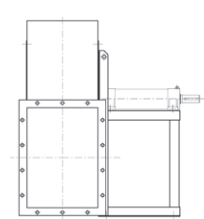

Accionamiento a transmisión, turbina montada en el eje soporte. Soporte montado sobre la silleta.

Orientaciones

RD 0 RD45 RD90 RD135 RD180 RD225 RD270 RD315

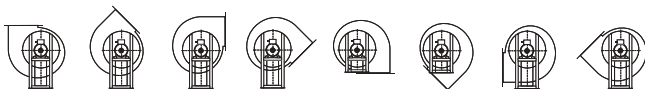

LG 0 LG45 LG90 LG135 LG180 LG225 LG270 LG315

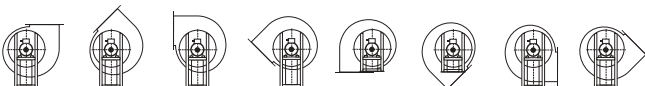

Curvas Características

CAAB-X 400

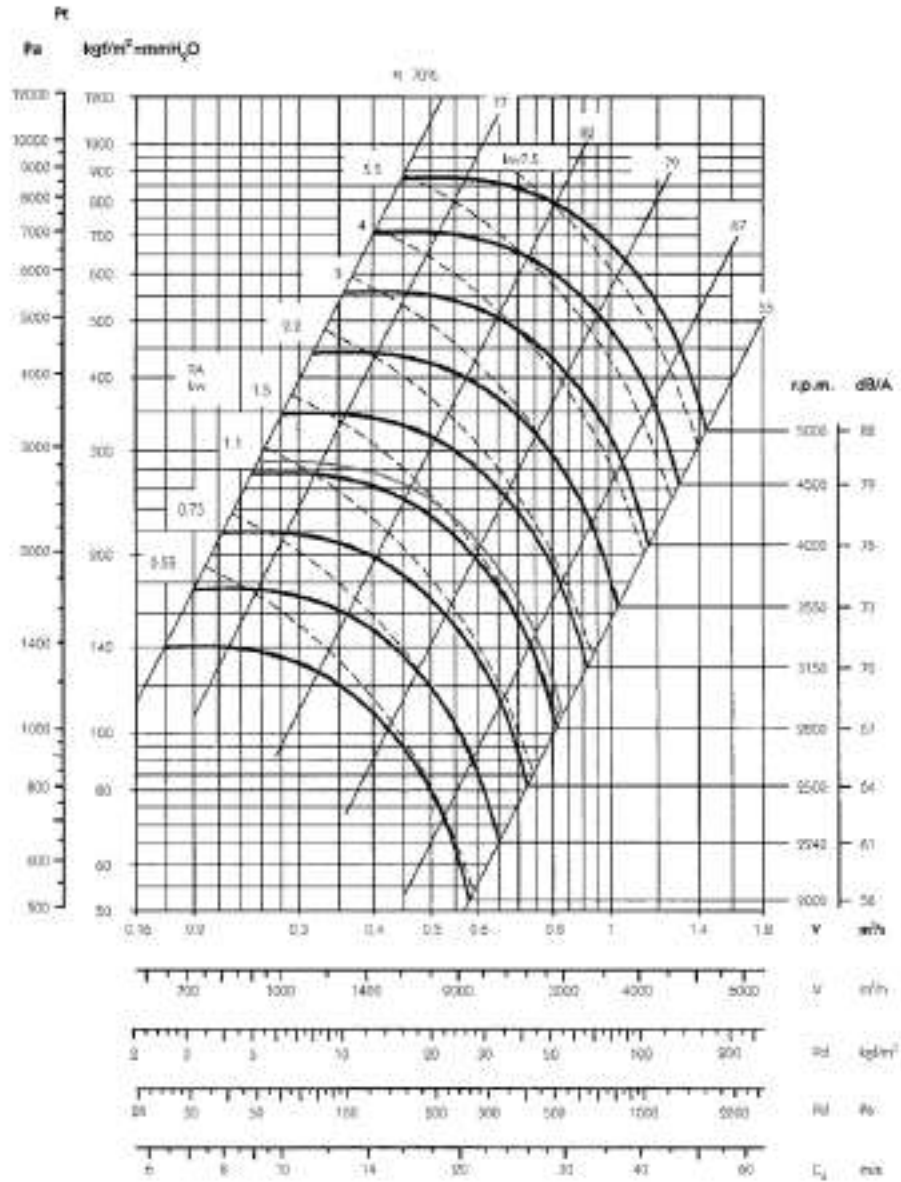

LARGE SERIES

Margen sobre el caudal ± 5 %
 Margen del nivel sonoro +3...5dB
 Margen kW absorbidos ± 3%

Características en impulsión.

Rpm máximas admisibles

Clase 1	
≤ 100 °C	4500
101 ... 200 °C	4000
201 ... 300 °C	3550

Curvas Características

CAAB-X 450

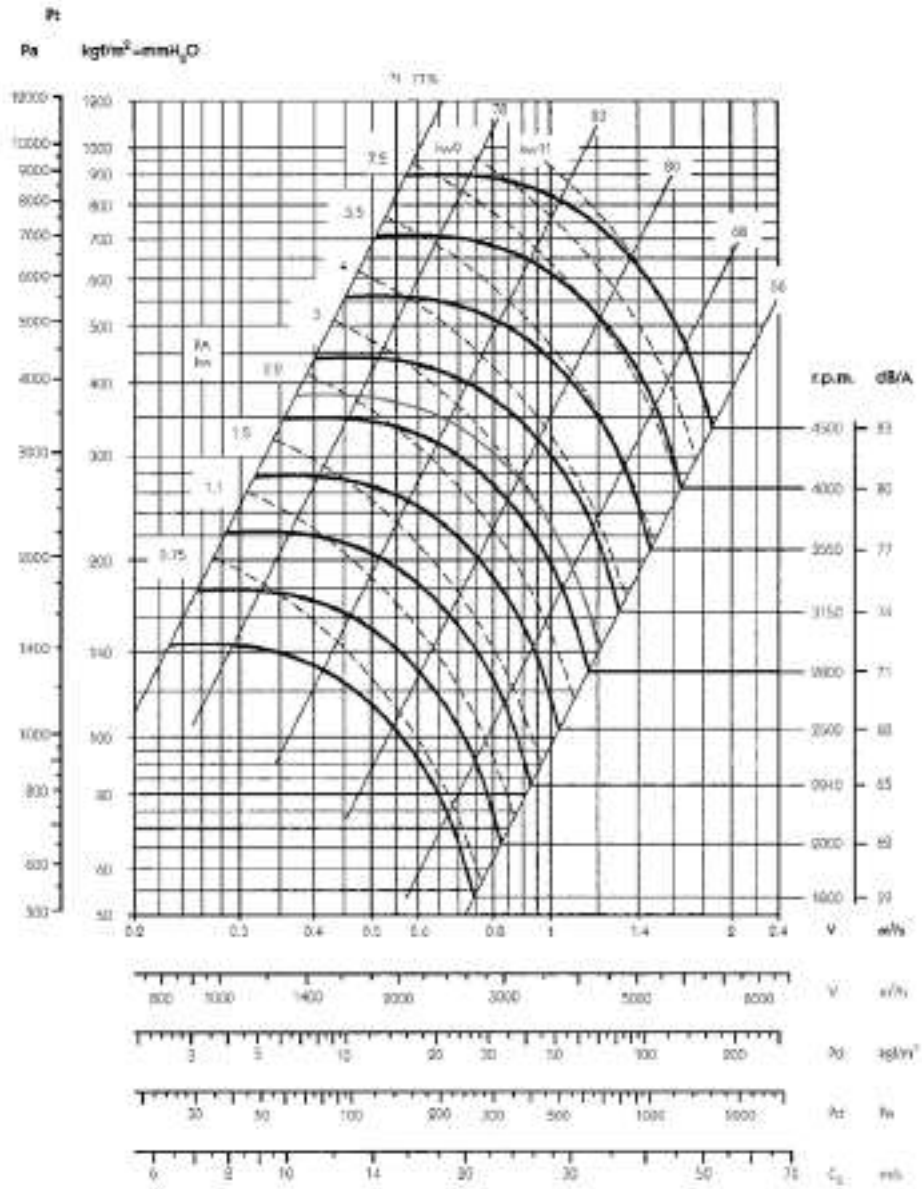

Margen sobre el caudal ± 5 %
 Margen del nivel sonoro +3...5dB
 Margen kW absorbidos ± 3%

Características en impulsión.

Rpm máximas admisibles

Clase 1	
≤ 100 °C	4250
101 ... 200 °C	3750
201 ... 300 °C	3350

Curvas Características

CAAB-X 500

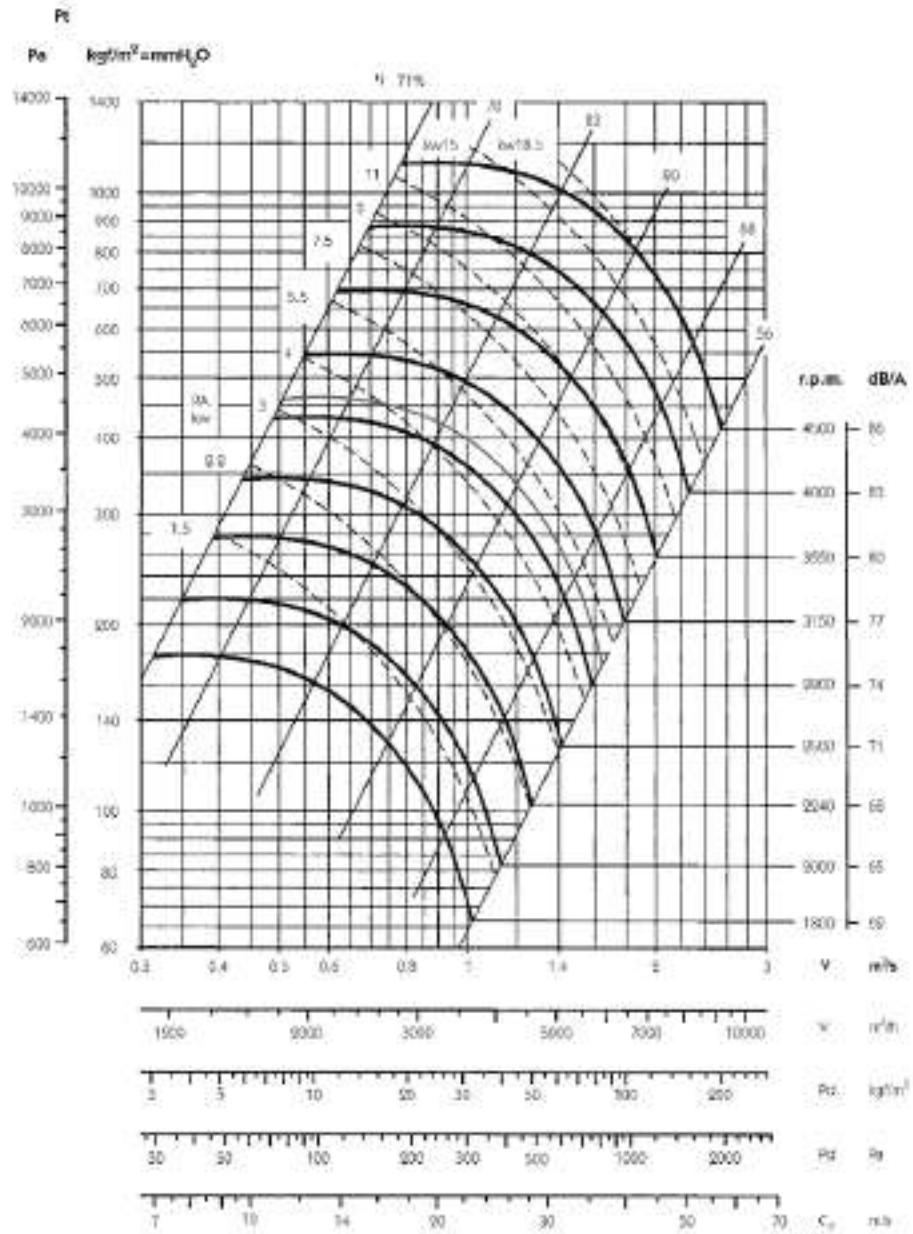

LARGE SERIES

Margen sobre el caudal ± 5 %
 Margen del nivel sonoro +3...5dB
 Margen kW absorbidos ± 3%

Características en impulsión.

Rpm máximas admisibles

Clase 1	
≤ 100 °C	4000
101 ... 200 °C	3550
201 ... 300 °C	3150

Curvas Características

CAAB-X 560

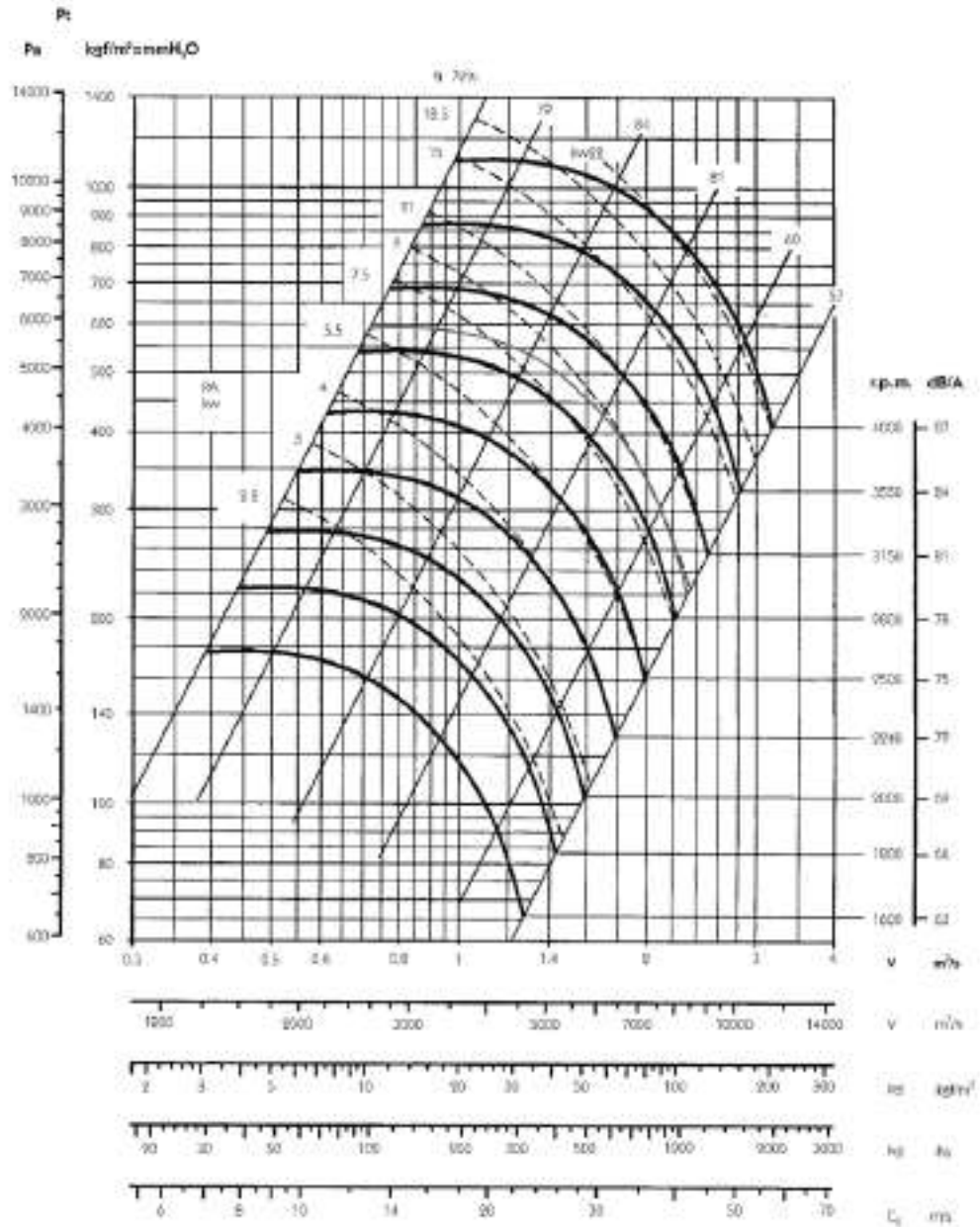

Margen sobre el caudal $\pm 5\%$
 Margen del nivel sonoro $+3...5\text{dB}$
 Margen kW absorbidos $\pm 3\%$

Características en impulsión.

Rpm máximas admisibles

Clase 1	
$\leq 100\text{ }^{\circ}\text{C}$	3750
101 ... 200 $^{\circ}\text{C}$	3350
201 ... 300 $^{\circ}\text{C}$	3000

Curvas Características

CAAB-X 630

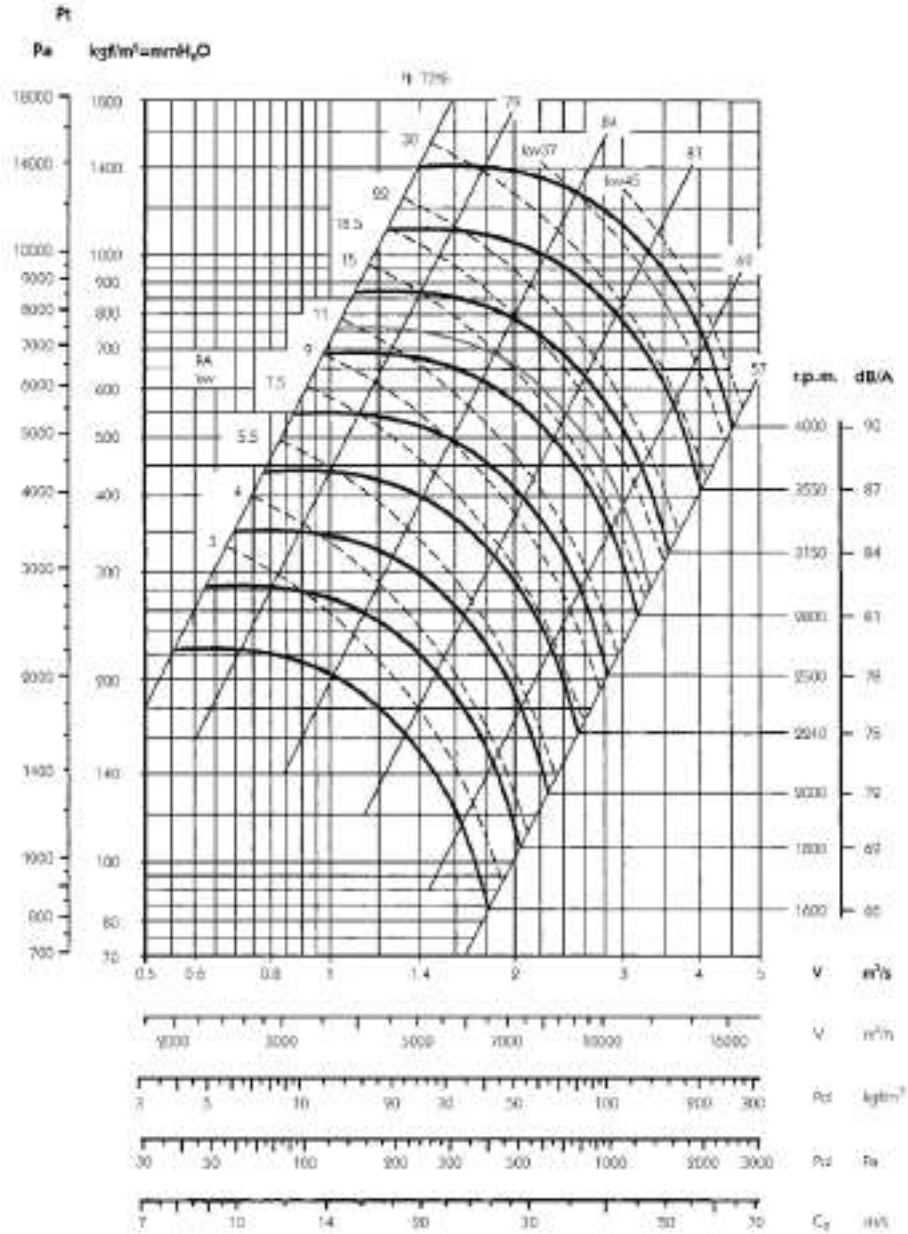

LARGE SERIES

Margen sobre el caudal ± 5 %
 Margen del nivel sonoro +3...5dB
 Margen kW absorbidos ± 3%

Características en impulsión.

Rpm máximas admisibles

Clase 1	
≤ 100 °C	3550
101 ... 200 °C	3150
201 ... 300 °C	2800

Curvas Características

CAAB-X 710

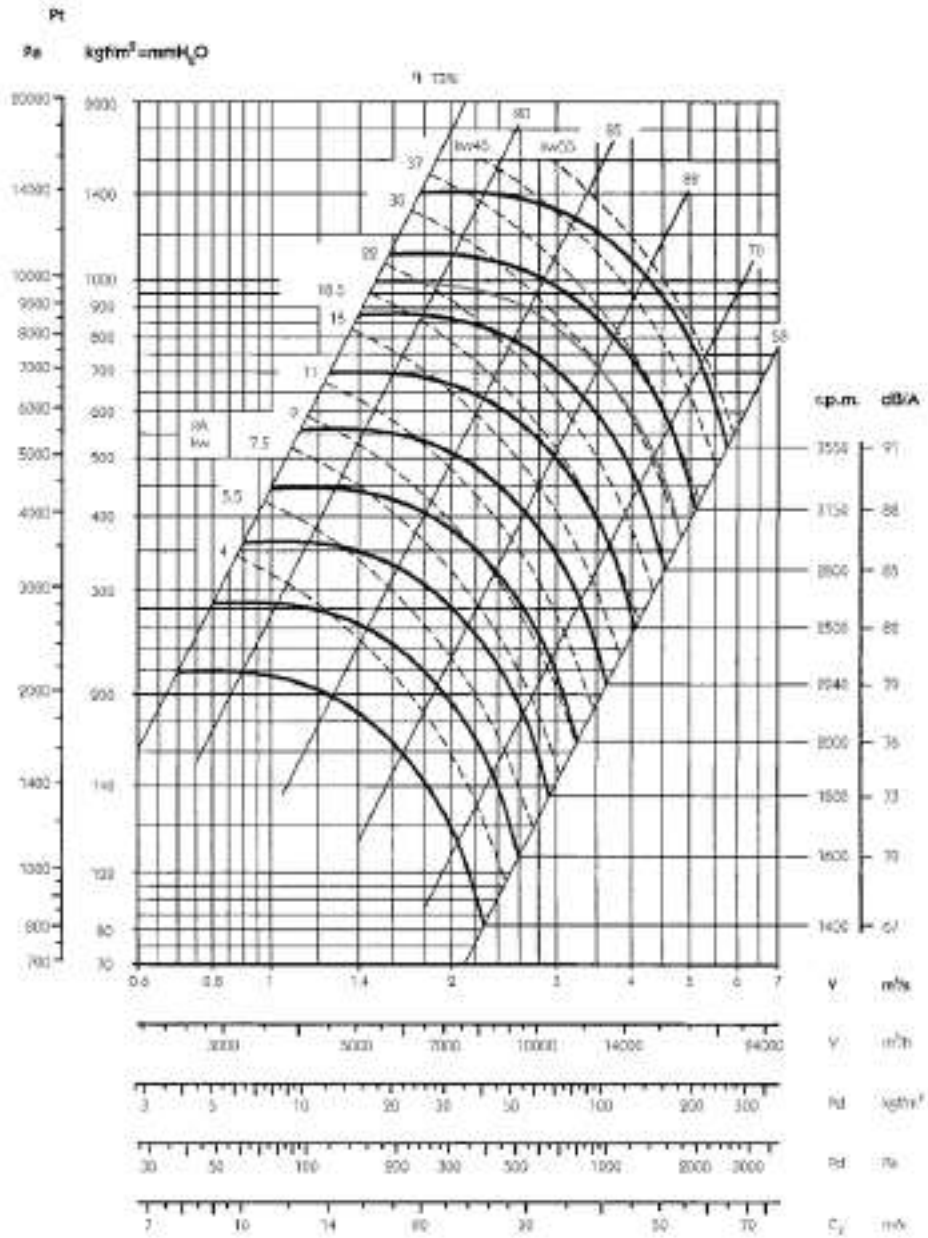

Margen sobre el caudal $\pm 5\%$
 Margen del nivel sonoro $+3...5\text{dB}$
 Margen kW absorbidos $\pm 3\%$

Características en impulsión.

Rpm máximas admisibles

Clase 1	
$\leq 100\text{ }^\circ\text{C}$	3350
101 ... 200 $^\circ\text{C}$	3000
201 ... 300 $^\circ\text{C}$	2650

Curvas Características

CAAB-X 800

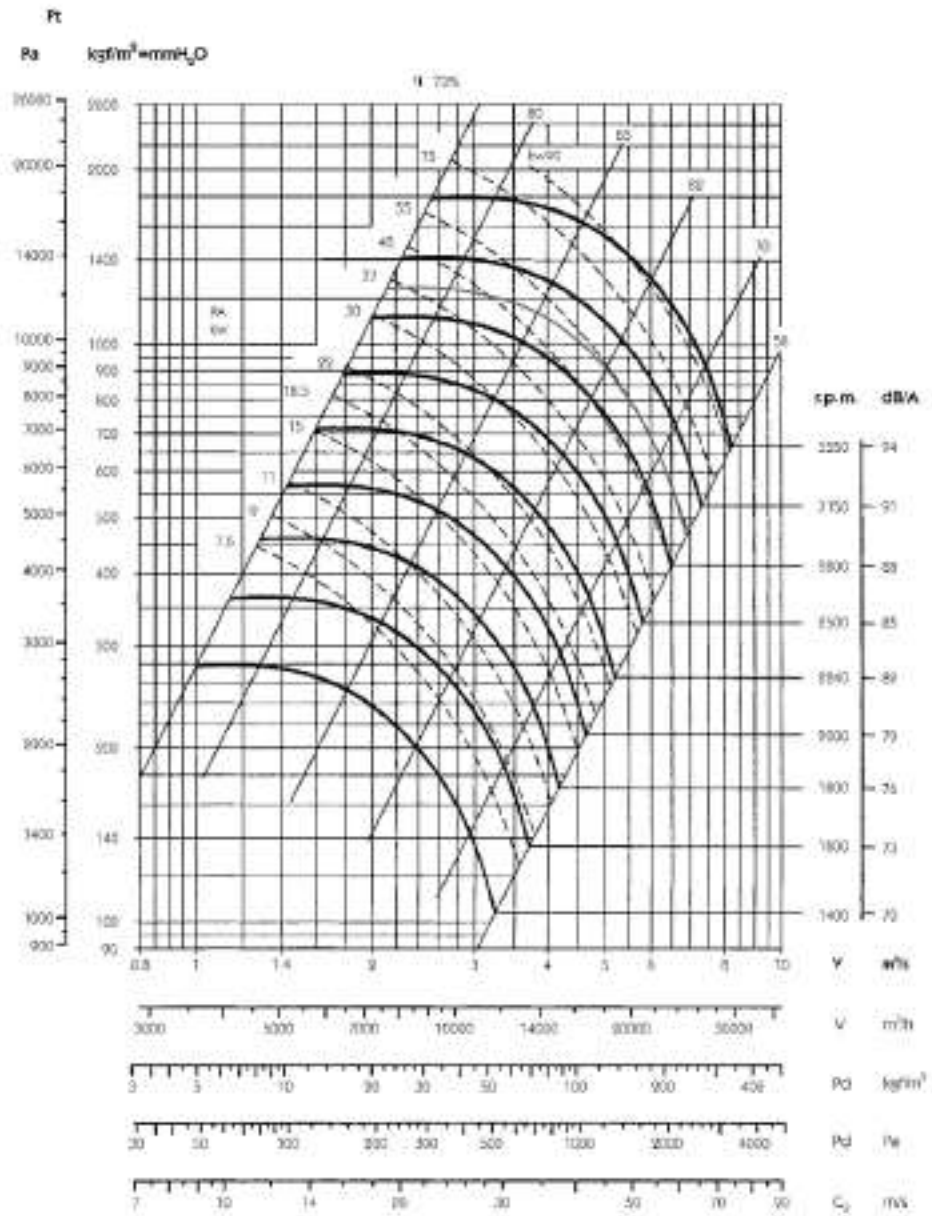

Margen sobre el caudal ± 5 %
 Margen del nivel sonoro +3...5dB
 Margen kW absorbidos ± 3%

Características en impulsión.

Rpm máximas admisibles

Clase 1	
≤ 100 °C	3150
101 ... 200 °C	2800
201 ... 300 °C	2500

Curvas Características

CAAB-X 900

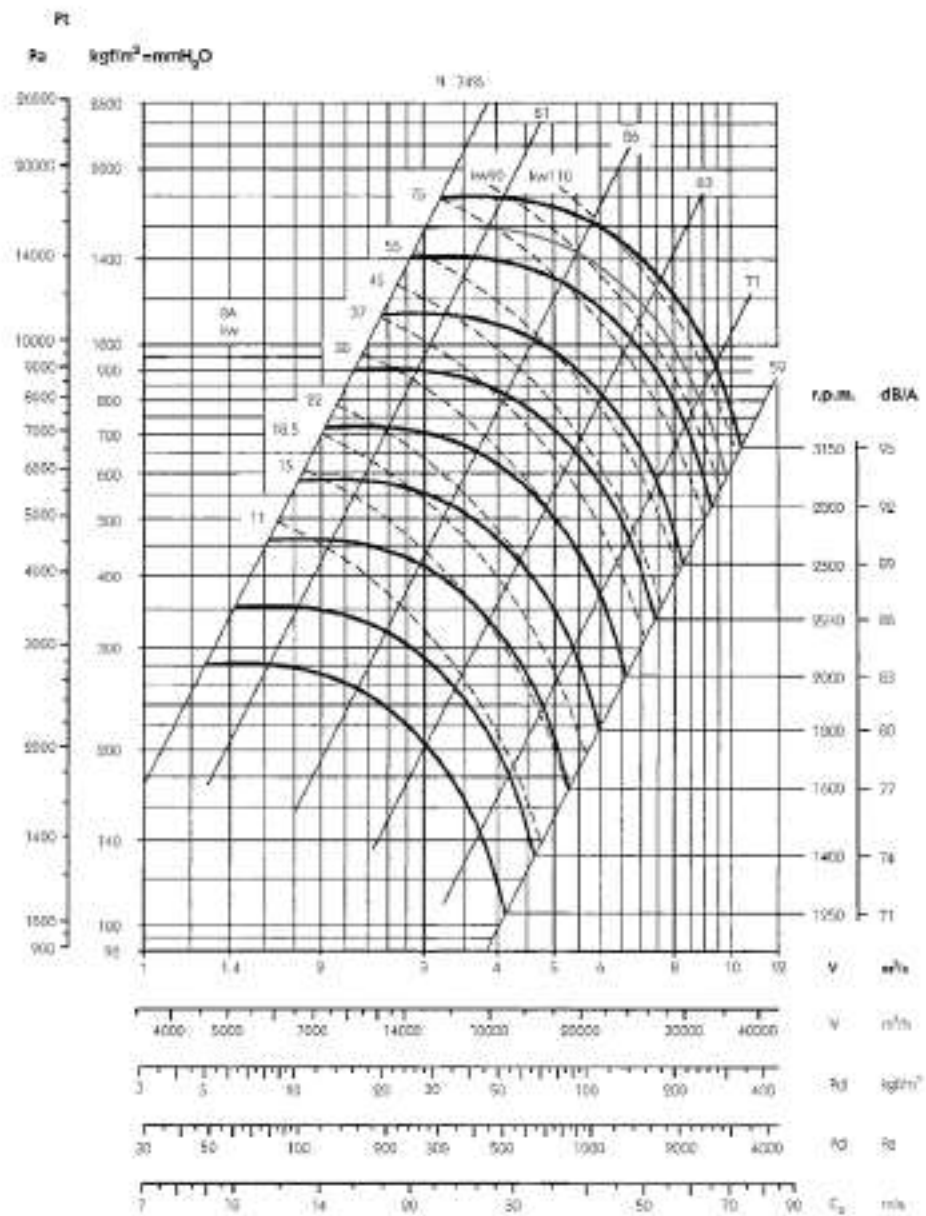

Margen sobre el caudal $\pm 5\%$
 Margen del nivel sonoro $+3...5\text{dB}$
 Margen kW absorbidos $\pm 3\%$

Características en impulsión.

Rpm máximas admisibles

Clase 1	
$\leq 100\text{ }^{\circ}\text{C}$	3000
101 ... 200 $^{\circ}\text{C}$	2650
201 ... 300 $^{\circ}\text{C}$	2360

Curvas Características

CAAB-X 1000

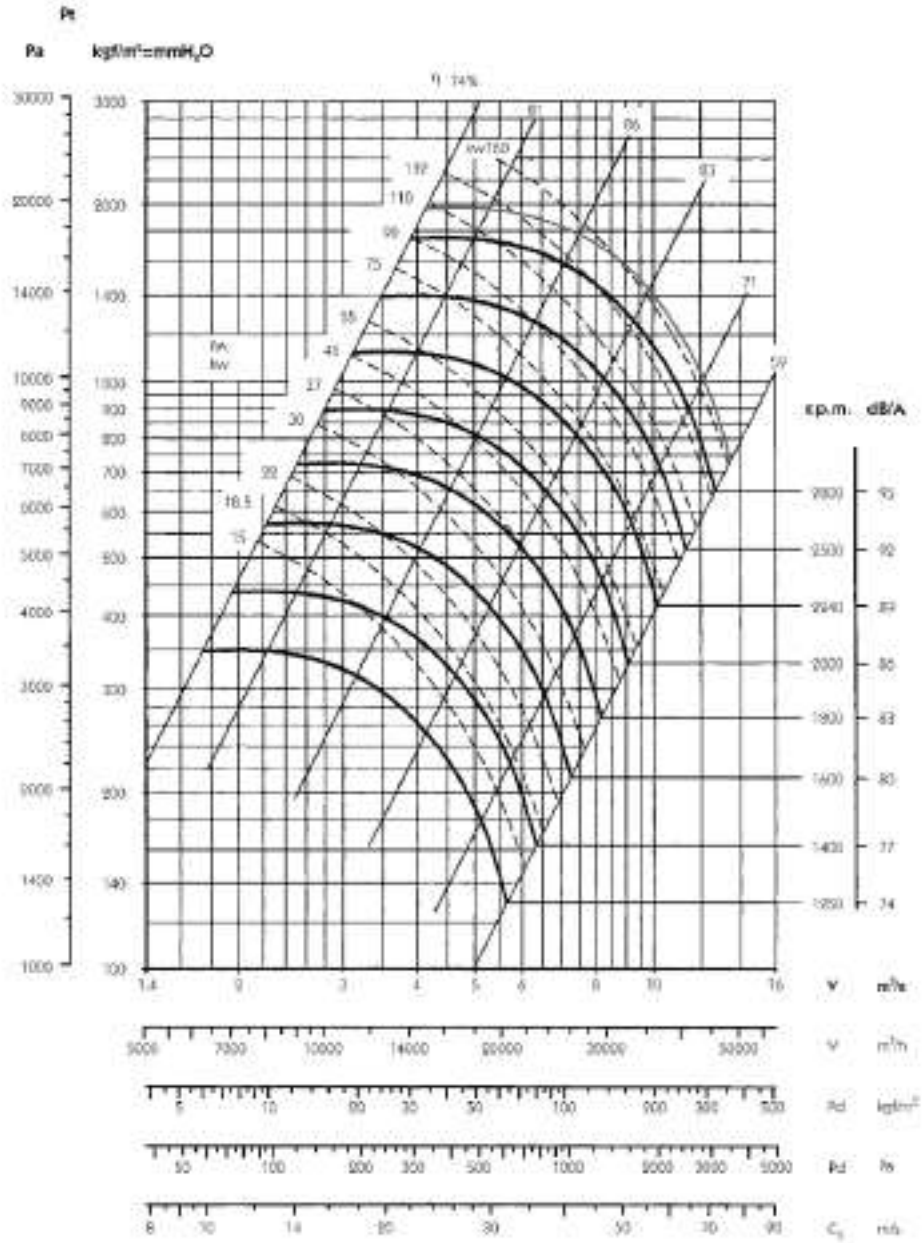

LARGE SERIES

Margen sobre el caudal $\pm 5\%$
 Margen del nivel sonoro $+3...5\text{dB}$
 Margen kW absorbidos $\pm 3\%$

Características en impulsión.

Rpm máximas admisibles

Clase 1	
$\leq 100\text{ }^\circ\text{C}$	2800
101 ... 200 $^\circ\text{C}$	2500
201 ... 300 $^\circ\text{C}$	2240

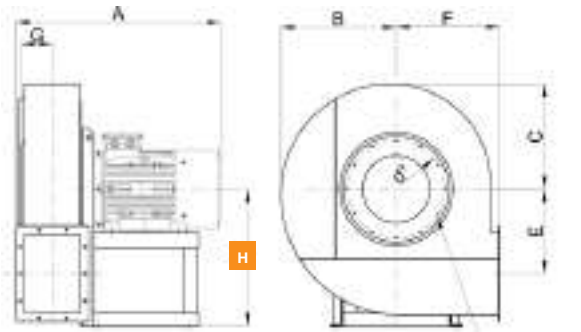
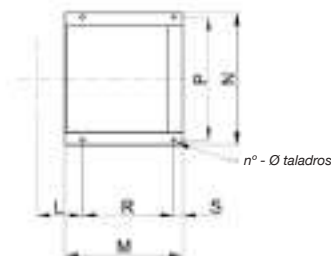
Dimensiones mm
CAAB 400...1000

n°v - Øv tornillos

n° - Ø taladros

ORIENTACIONES							
H0	H1	H2	H3	H4	H5	H6	H7
RD0	RD45	RD90	RD135	RD180	RD225	RD270	RD315
LG0	LG45	LG90	LG135	LG180	LG225	LG270	LG315

H * La medida de la cota H (distancia entre el suelo y el eje) varía según las orientaciones

MOD.	FRAME	A	B	C	E	F	G	HO-1-2-3	H4-5	H6-7	L	M	N	P	R	S	n°	Φ	d ¹	n°v	Φv
CAAB-400	90 L/2	480	305	285	217	280	88	375	280	375	126	215	269	245	140	25	4	10	241	8	M6
CAAB-450	112 M/2	525	335	310	242	300	97	400	300	400	135	260	312	280	185	25	4	12	292	8	M8
CAAB-500	112 M/2	545	375	345	272	335	106	450	335	450	145	260	312	280	185	25	4	12	332	8	M8
CAAB-500	132 SB/2	635	375	345	272	335	106	450	335	450	145	320	342	310	245	25	4	12	332	8	M8
CAAB-560	132 SB/2	660	425	385	308	375	117	500	375	500	156	320	342	310	245	25	4	12	366	8	M8
CAAB-560	160 MA/2	730	425	385	308	375	117	500	375	500	156	425	440	400	345	30	4	14	366	8	M8
CAAB-630	160 L/2	835	475	430	348	425	129	560	425	560	168	425	440	400	345	30	4	14	405	8	M8
CAAB-710	180 M/2	900	525	485	389	475	143	630	475	630	201	470	550	510	370	30	4	17	448	12	M8
CAAB-710	200 LB/2	960	525	485	389	475	143	630	475	630	211	540	608	565	420	40	4	19	448	12	M8
CAAB-800	225 M/2	1045	595	545	440	530	159	710	530	710	228	550	668	625	430	40	4	19	497	12	M8
CAAB-800	280 S/2	1245	595	545	440	530	159	710	530	710	228	740	784	725	610	50	4	21	497	12	M8
CAAB-900	280 S/2	1280	665	620	496	600	176	800	600	800	245	740	784	725	610	50	4	21	551	12	M8
CAAB-900	315 S/2	1280	665	620	496	600	176	800	600	800	245	800	890	810	670	50	4	21	551	12	M8
CAAB-1000	315 MA/2	1435	745	695	556	670	195	900	670	900	265	800	890	810	670	50	4	21	629	12	M8
CAAB-1000	315 MC/2	1435	745	695	556	670	195	900	670	900	265	800	890	810	670	50	4	21	629	12	M8

(*) Para construcciones a "ALTA TEMP." cotas "A-M-R" + 50 mm.
 (kg) Peso ventilador con motor.
 WD² = Momento de inercia del rodete, expresado en Kg x m²

Dimensiones mm

CAAB 400...1000

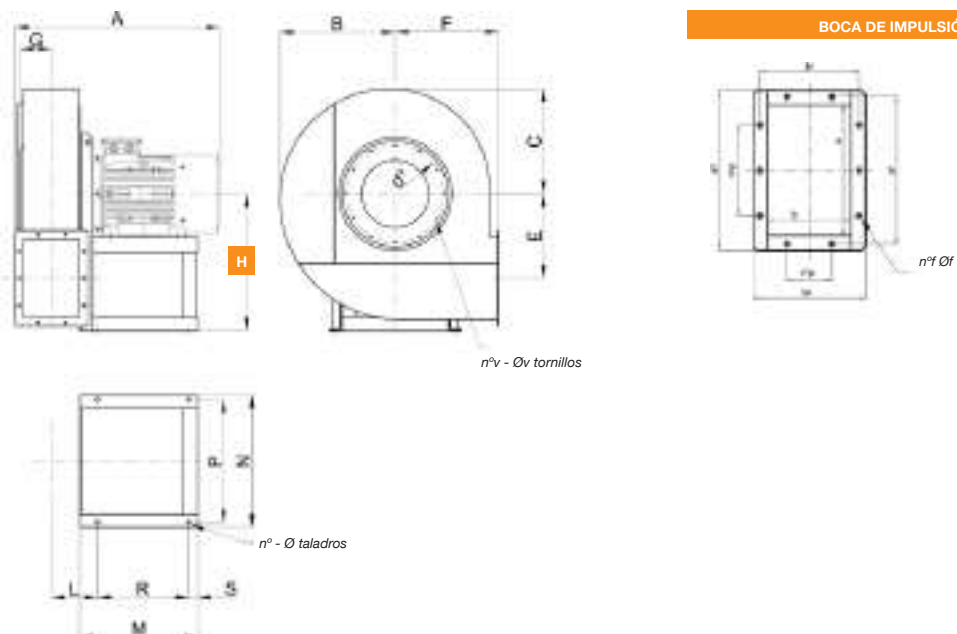

BOCA IMPULSIÓN												
MOD.	a	b	a ¹	b ¹	a ²	b ²	n ¹ p	n ² p	n ^f	Øf	kg	WD ²
CAAB-400	205	146	241	182	275	216	1-112	1-112	8	12	55	0,6
CAAB-450	229	164	265	200	299	234	1-112	1-112	8	12	85	1
CAAB-500	256	183	292	219	326	253	1-112	2-112	10	12	100	1,5
CAAB-500	256	183	292	219	326	253	1-112	2-112	10	12	120	1,7
CAAB-560	288	205	332	249	368	285	1-125	2-125	10	12	140	2,3
CAAB-560	288	205	332	249	368	285	1-125	2-125	10	12	175	2,7
CAAB-630	322	229	366	273	402	309	1-125	2-125	10	12	240	4,5
CAAB-710	361	256	405	300	441	336	1-125	2-125	10	12	280	7
CAAB-710	361	256	405	300	441	336	1-125	2-125	10	12	410	8,6
CAAB-800	404	288	448	332	484	368	2-125	3-125	14	12	490	12
CAAB-800	404	288	448	332	484	368	2-125	3-125	14	12	670	15,5
CAAB-900	453	322	497	366	533	402	2-125	3-125	14	12	880	18
CAAB-900	453	322	497	366	533	402	2-125	3-125	14	12	1080	20,5
CAAB-1000	507	361	551	405	587	441	2,125	3,125	14	12	1150	35
CAAB-1000	507	361	551	405	587	441	2,125	3,125	14	12	1280	50

(*) Para construcciones a "ALTA TEMP." cotas "A-M-R" + 50 mm.
(kg) Peso ventilador con motor.
WD² = Momento de inercia del rodetes, expresado en Kg x m²

Dimensiones mm

CAAB-X 400...1000

SISTEMA
1

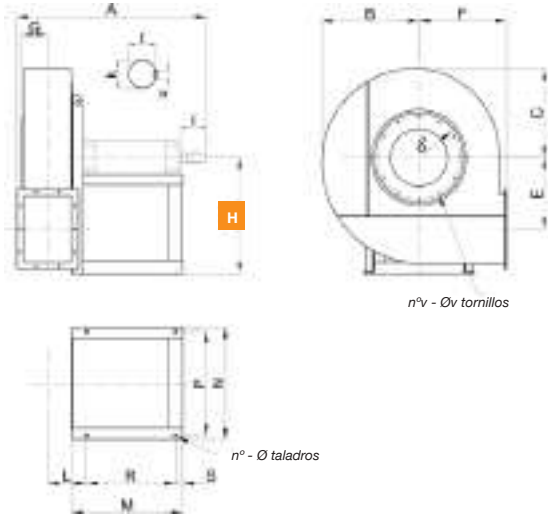

SISTEMA
12

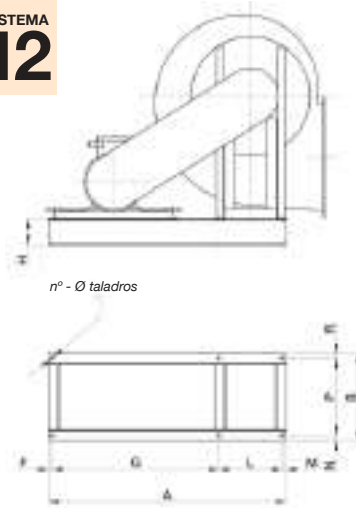

MOD.	A*	B	C	E	F	G	H0-1-2-3	H4-5	H6-7	L
CAAB 400	745	305	285	217	280	88	375	280	375	126
CAAB 450	865	335	310	242	300	97	400	300	400	135
CAAB 500	885	375	345	272	335	106	450	335	450	145
CAAB 560	920	425	385	308	375	117	500	375	500	156
CAAB 630	945	475	430	348	425	129	560	425	560	168
CAAB 710	1060	535	485	389	475	143	530	475	630	181
CAAB 800	1145	595	545	440	530	159	600	530	710	198
CAAB 900	1260	665	620	496	600	176	670	600	800	215
CAAB 1000	1565	745	695	556	670	195	750	670	900	285

MOD.	A	B*	H	F	G	L	M	N	P*
CAAB 400	900	450	120	20	550	310	20	25	400
CAAB 450	1055	530	120	25	680	330	20	25	480
CAAB 500	1055	530	120	25	680	330	20	25	480
CAAB 560	1265	485	160	25	830	385	25	30	430
CAAB 630	1445	550	160	25	1010	385	25	30	495
CAAB 710	1505	575	180	30	1050	395	30	30	515
CAAB 800	1775	700	180	30	1280	435	30	30	640
CAAB 900	1880	750	180	30	1320	500	30	35	680
CAAB 1000	2100	850	180	35	1230	800	35	35	780

MOD.	M*	N	P	R*	S	n°	Φ	k	l	t	u
CAAB 400	480	350	310	400	30	4	14	28 K6	60	31	8
CAAB 450	560	370	330	480	30	4	14	38 K6	80	41	10
CAAB 500	560	370	330	480	30	4	14	38 K6	80	41	10
CAAB 560	520	438	385	430	40	4	17	42 K6	110	45	12
CAAB 630	520	438	385	430	40	4	17	48 K6	110	51,5	14
CAAB 710	605	456	395	515	40	4	19	48 K6	110	51,5	14
CAAB 800	655	496	435	565	40	4	19	55 m6	110	59	16
CAAB 900	705	564	500	605	50	4	19	65 m6	140	69	18
CAAB 1000	940	880	820	780	60	4	24	80 m6	170	85	22

MOD.	R	n°	Φ	kg
CAAB 400	25	6	14	40
CAAB 450	25	6	14	45
CAAB 500	25	6	14	45
CAAB 560	25	6	17	70
CAAB 630	25	6	17	90
CAAB 710	30	6	19	100
CAAB 800	30	6	19	130
CAAB 900	35	6	19	185
CAAB 1000	35	6	24	190

MOD.	d ¹	n°v	Φv	kg	WD ²
CAAB 400	241	8	M6	60	0,6
CAAB 450	292	8	M8	75	1
CAAB 500	332	8	M8	90	1,7
CAAB 560	366	8	M8	125	2,7
CAAB 630	405	8	M8	170	4,5
CAAB 710	448	12	M8	220	8,6
CAAB 800	497	12	M8	300	15,5
CAAB 900	551	12	M8	500	20,5
CAAB 1000	629	12	M8	850	50

(*) Para construcciones a "ALTA TEMP." en mod. de 400 a 800, cotas "B-P" + 50 mm.
Kg = Peso de la base soporte

(*) Para construcciones a "ALTA TEMP." en mod. de 400 a 800, cotas "A-M-R" + 50 mm.
(kg) Peso ventilador sin motor.
WD² = Momento de inercia del rodetes, expresado en Kg x m²

BOCA DE IMPULSIÓN

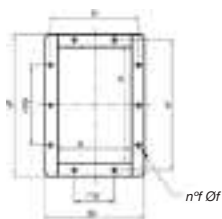

BOCA IMPULSIÓN

MOD.	a	b	a ¹	b ¹	a ²	b ²	n°p	n°p	n°f	Φf
CAAB 400	205	146	241	182	275	216	1-112	1-112	8	12
CAAB 450	229	164	265	200	299	234	1-112	1-112	8	12
CAAB 500	256	183	292	219	326	253	1-112	2-112	10	12
CAAB 560	288	205	332	249	368	285	1-125	2-125	10	12
CAAB 630	322	229	366	273	402	309	1-125	2-125	10	12
CAAB 710	361	256	405	300	441	336	1-125	2-125	10	12
CAAB 800	404	288	448	332	484	368	2-125	3-125	14	12
CAAB 900	453	322	497	366	533	402	2-125	3-125	14	12
CAAB 1000	507	361	551	405	587	441	2-125	3-125	14	12

ORIENTACIONES

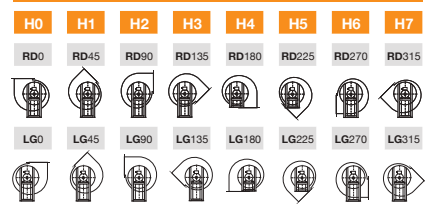

H * La medida de la cota H (distancia entre el suelo y el eje) varía según las orientaciones

Accesorios

Contrabrida aspiración

n° - Ø taladros

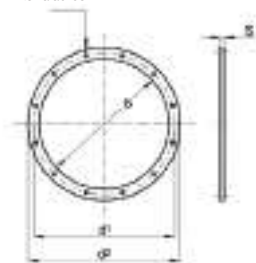

MOD.	d	d¹	d²	n°	Φ	s	kg
CAAB 400	229	265	299	8	9	4	0,8
CAAB 450	255	292	325	8	11	4	1
CAAB 500	286	332	366	8	11	5	1,6
CAAB 560	321	366	401	8	11	5	1,8
CAAB 630	361	405	441	8	11	5	2
CAAB 710	406	448	486	12	11	5	2,2
CAAB 800	456	497	536	12	11	5	2,5
CAAB 900	506	551	586	12	11	5	2,7
CAAB 1000	568	629	668	12	11	6	4,6

Contrabrida impulsión

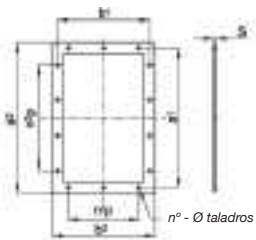

MOD.	a	b	a¹	b¹	a²	b²	n¹p	n²p	n°	Φ	s	kg
CAAB 400	205	146	241	182	275	216	1-112	1-112	8	12	4	0,9
CAAB 450	229	164	265	200	299	234	1-112	1-112	8	12	4	1
CAAB 500	256	183	292	219	326	253	1-112	2-112	10	12	4	1,1
CAAB 560	288	205	332	249	368	285	1-125	2-125	10	12	5	1,8
CAAB 630	322	229	366	273	402	309	1-125	2-125	10	12	5	2
CAAB 710	361	256	405	300	441	336	1-125	2-125	10	12	5	2,2
CAAB 800	404	288	448	332	484	368	2-125	3-125	14	12	5	2,4
CAAB 900	453	322	497	366	533	402	2-125	3-125	14	12	5	2,7
CAAB 1000	507	361	551	405	587	441	2-125	3-125	14	12	5	3

Red protección en aspiración

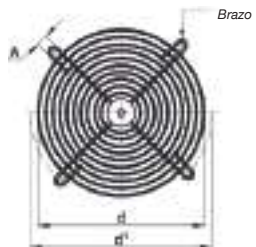

MOD.	d	d¹	A	n°	kg
CAAB 400	229	265	9	4	0,25
CAAB 450	255	292	11	4	0,3
CAAB 500	286	332	11	4	0,35
CAAB 560	321	366	11	4	0,4
CAAB 630	361	405	11	8	0,7
CAAB 710	406	448	11	8	0,8
CAAB 800	456	497	11	8	0,9
CAAB 900	506	551	11	8	1
CAAB 1000	568	629	11	8	1,2

Junta anti vibratoria en aspiración

n° - Ø taladros

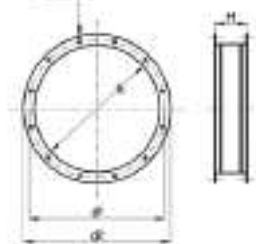

MOD.	d	d¹	d²	n°	Φ	H	kg
CAAB 400	229	265	299	8	9	200	2
CAAB 450	255	292	325	8	11	200	2,2
CAAB 500	286	332	366	8	11	200	3,4
CAAB 560	321	366	401	8	11	200	3,8
CAAB 630	361	405	441	8	11	200	4,2
CAAB 710	406	448	486	12	11	200	4,6
CAAB 800	456	497	536	12	11	200	5,1
CAAB 900	506	551	586	12	11	200	5,6
CAAB 1000	568	629	668	12	11	200	9,4

Junta anti vibratoria en impulsión

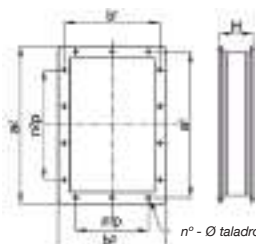

MOD.	a	b	a¹	b¹	a²	b²	n¹p	n²p	n°	Φ	H	kg
CAAB 400	205	146	241	182	275	216	1-112	1-112	8	12	200	2
CAAB 450	229	164	265	200	299	234	1-112	1-112	8	12	200	2,2
CAAB 500	256	183	292	219	326	253	1-112	2-112	10	12	200	2,4
CAAB 560	288	205	332	249	368	285	1-125	2-125	10	12	200	3,8
CAAB 630	322	229	366	273	402	309	1-125	2-125	10	12	200	4,2
CAAB 710	361	256	405	300	441	336	1-125	2-125	10	12	200	4,6
CAAB 800	404	288	448	332	484	368	2-125	3-125	14	12	200	5
CAAB 900	453	322	497	366	533	402	2-125	3-125	14	12	200	5,6
CAAB 1000	507	361	551	405	587	441	2-125	3-125	14	12	200	6,2

LARGE SERIES

Accesorios

Regulador de caudal en aspiración

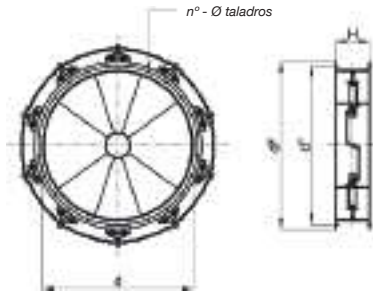

MOD.	d	d ¹	d ²	n°	Φ	H	kg
CAAB 560	321	366	401	8	11	200	24
CAAB 630	361	405	441	8	11	250	26
CAAB 710	406	448	486	12	11	250	30
CAAB 800	456	497	536	12	11	250	32
CAAB 900	506	551	586	12	11	250	45
CAAB 1000	568	629	668	12	11	250	50

Dámper de aletas contrapuestas

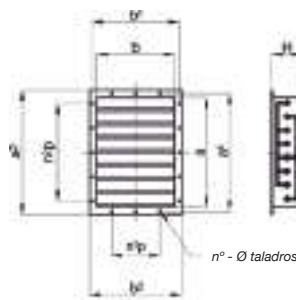

MOD.	a	b	a ¹	b ¹	a ²	b ²	n ¹ p	n ² p	n ⁰	Φ	H (1)	H (2)	kg (1)	kg (2)
CAAB 630	322	229	366	273	402	309	1-125	2-125	10	12	220	250	11	12
CAAB 710	361	256	405	300	441	336	1-125	2-125	10	12	220	250	14	15
CAAB 800	404	288	448	332	484	368	2-125	3-125	14	12	220	250	18	19
CAAB 900	453	322	497	366	533	402	2-125	3-125	14	12	220	250	21	22
CAAB 1000	507	361	551	405	587	441	2-125	3-125	14	12	220	250	24	25

(1) Hasta 300 mm H₂O.
(2) A partir de 300 mm H₂O.

Amortiguadores

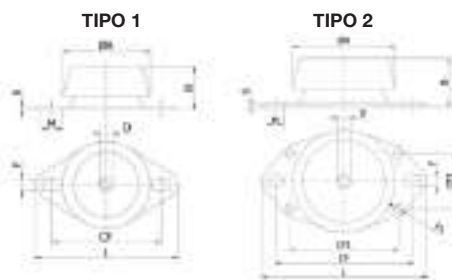

MOD.	MODELO AMORTIGUADORES	TIPO	øA	B	D	CF	CF1	CF2	F	øF1	L	M	S
CAAB 400	CF 623110	1	67	33...34	10	76,5	-	-	9	-	90,5	16	2
CAAB 450	CF 623110	1	67	33...34	10	76,5	-	-	9	-	90,5	16	2
CAAB 500	CF 623110	1	67	33...34	10	76,5	-	-	9	-	90,5	16	2
CAAB 560	CF 623110	1	67	33...34	10	76,5	-	-	9	-	90,5	16	2
CAAB 630	CF 623110	1	67	33...34	10	76,5	-	-	9	-	90,5	16	2
CAAB 710	CF 623110	1	67	33...34	10	76,5	-	-	9	-	90,5	16	2
CAAB 800	CF 924512	2	92	44...45	12	120	98	50	10,5	8,5	130	15,5	2,5
CAAB 900	CF 924512	2	92	44...45	12	120	98	50	10,5	8,5	130	15,5	2,5
CAAB 1000	CF 924512	2	92	44...45	12	120	98	50	10,5	8,5	130	15,5	2,5

Silenciadores circulares



Los silenciadores se utilizan para bajar el nivel sonoro en instalaciones de acondicionamiento o ventilación, fabricados en acero cincado

- Bajo demanda: otras construcciones en diferentes materiales.

øD	øE	L	øI	F	øM	øD	øE	L	øI	F	øM
315	515	ØD,1.5ØD,2ØD	355	8	M8	900	1100	ØD,1.5ØD,2ØD	970	16	M10
355	555	ØD,1.5ØD,2ØD	395	8	M8	1000	1200	ØD,1.5ØD,2ØD	1070	16	M10
400	600	ØD,1.5ØD,2ØD	450	8	M8	1120	1320	ØD,1.5ØD,2ØD	1190	20	M10
450	650	ØD,1.5ØD,2ØD	500	8	M8	1250	1450	ØD,1.5ØD,2ØD	1320	20	M10
500	700	ØD,1.5ØD,2ØD	560	12	M8	1400	1600	ØD,1.5ØD,2ØD	1470	20	M10
560	760	ØD,1.5ØD,2ØD	620	12	M8	1500	1700	ØD,1.5ØD,2ØD	1570	20	M10
630	830	ØD,1.5ØD,2ØD	690	12	M8	1600	1800	ØD,1.5ØD,2ØD	1680	24	M14
710	910	ØD,1.5ØD,2ØD	770	16	M8	1700	1900	ØD,1.5ØD,2ØD	1780	24	M14
800	1000	ØD,1.5ØD,2ØD	860	16	M8	1800	2000	ØD,1.5ØD,2ØD	1880	24	M14

MOTOR DIRECTO

CAAE

Ventiladores centrífugos de alta presión y simple aspiración de gran robustez con envolvente y turbina en chapa de acero

Diseñados para aire limpio y polvoriento



* Las imágenes son solo a nivel ilustrativo, el producto puede variar en función del tamaño, especificaciones y posición.

Ventilador:

- Envolvente en chapa de acero.
- Turbina a reacción en chapa de acero de gran robustez, especialmente diseñados para aire limpio y polvoriento.
- Motor directamente acoplado.
- Con trampilla de inspección y limpieza a partir del tamaño 560.
- Todas las carcasas soldadas en continuo.

Motor:

- Motores con eficiencia IE3 para potencias iguales o superiores a 0,75 kW, excepto monofásicos, 2 velocidades y 8 polos.
- Motores clase F con rodamientos a bolas. Protección IP55.
- Trifásicos 230/400 V 50 Hz (hasta 4 kW) y 400/690 V 50 Hz (potencias superiores a 4 kW).
- Temperatura máxima del aire a transportar: -25 °C +90 °C.

Acabado:

- Anticorrosivo en resina de poliéster polimerizada a 190 °C, previo desengrase con tratamiento nanotecnológico libre de fosfatos.

Bajo demanda:

- Bobinados especiales para diferentes tensiones.
- Ventilador preparado para transportar aire hasta +150 °C.
- Ejecuciones especiales para temperaturas +300 °C.
- Ventilador en acero inoxidable.
- Certificación ATEX Categoría 2.
- Acoplamiento elástico sistema 8.

Formas constructivas motor directo

SISTEMA 4

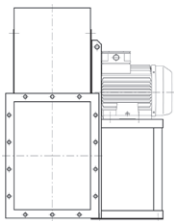

Accionamiento directo, turbina montada en el eje motor, montado sobre la silleta.

SISTEMA 5

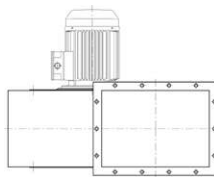

Accionamiento directo, turbina montada en el eje motor, motor de brida montado sobre la carcasa del ventilador.

SISTEMA 8

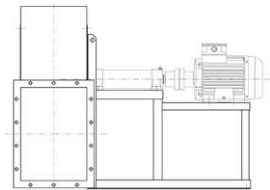

Accionamiento por acoplamiento elástico, turbina montada en el eje soporte, montado al motor mediante acoplamiento elástico. Todo montado conjuntamente sobre la silleta ventilador.

Orientaciones

RD 0 RD45 RD90 RD135 RD180 RD225 RD270 RD315

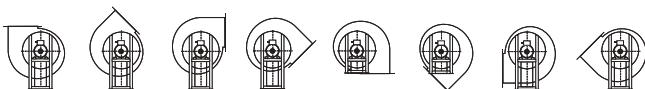

LG 0 LG45 LG90 LG135 LG180 LG225 LG270 LG315

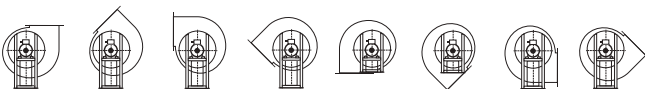

MOTOR A TRANSMISIÓN

CAAE-X

Ventiladores de alta presión accionados a transmisión, equipados con motor eléctrico, conjunto de poleas, correas y protectores normalizados según norma ISO-13857

Diseñados para aire limpio y polvoriento



Motor:

- Motores con eficiencia IE3.
- Motores clase F con rodamientos a bolas. Protección IP55.
- Trifásicos 230/400 V 50 Hz (hasta 4 kW) y 400/690 V 50 Hz (potencias superiores a 4 kW).
- Temperatura máxima del aire a transportar: -25 °C +90 °C.

Acabado:

- Anticorrosivo en resina de poliéster polimerizada a 190 °C, previo desengrase con tratamiento nanotecnológico libre de fosfatos.

Bajo demanda:

- Bobinados especiales para diferentes tensiones.
- Ventilador preparado para transportar aire hasta +300 °C.
- Ventilador en acero inoxidable.
- Certificación ATEX Categoría 2.
- Acoplamiento elástico sistema 8.

Ventilador:

- Envoltivo en chapa de acero.
- Turbina a reacción en chapa de acero de gran robustez, especialmente diseñados para aire limpio y polvoriento.
- Motor montado sobre bancada general.
- Con trampilla de inspección y limpieza a partir del tamaño 560.
- Todas las carcasas soldadas en continuo.

* Las imágenes son solo a nivel ilustrativo, el producto puede variar en función del tamaño, especificaciones y posición.

Formas constructivas motor a transmisión

SISTEMA 12

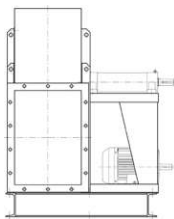

Accionamiento a transmisión, igual al SISTEMA 1, con el motor y ventilador montados en la bancada común. Posiciones de motor "W" o "Z" y excepcionalmente "X" o "Y".

SISTEMA 9

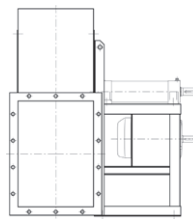

Accionamiento a transmisión, igual al SISTEMA 1, con el motor montado sobre bancada general.

SISTEMA 1

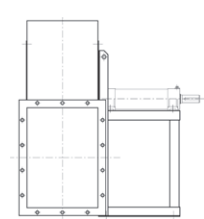

Accionamiento a transmisión, turbina montada en el eje soporte. Soporte montado sobre la silleta.

Orientaciones

RD 0 RD45 RD90 RD135 RD180 RD225 RD270 RD315

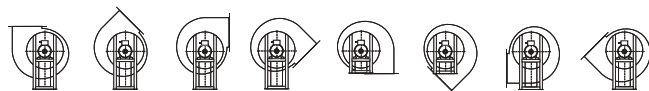

LG 0 LG45 LG90 LG135 LG180 LG225 LG270 LG315

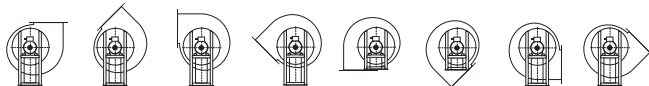

Curvas Características

CAAE 400

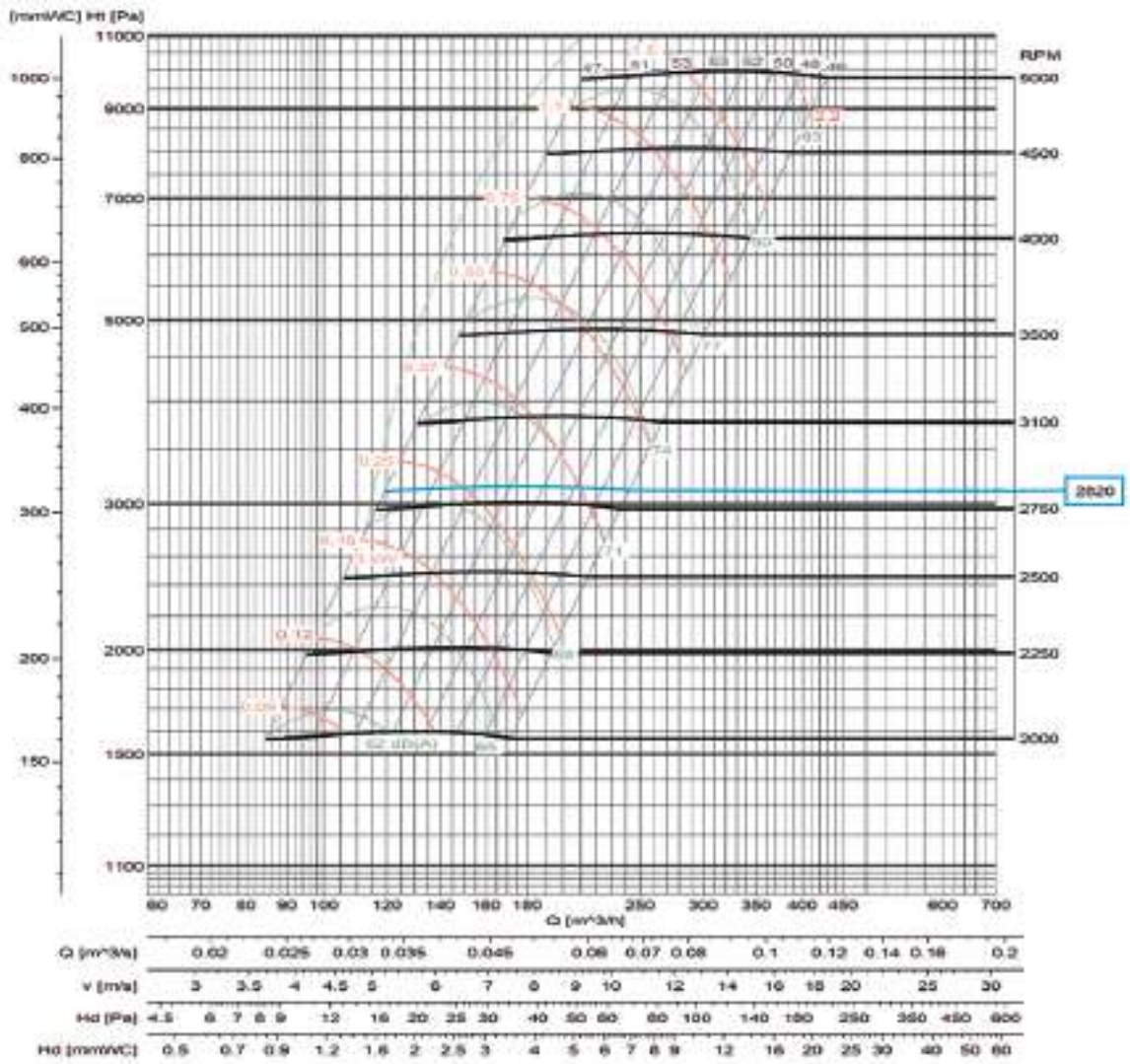

LARGE SERIES

Margen sobre el caudal ± 5 %
 Margen del nivel sonoro +3...5db
 Margen kW absorbidos ± 3%

Características en impulsión.

Rpm Características para:
 sistema 4 y 5 en motor
 directo con 2/4/6/8 polos
 según modelo.

Curvas Características

CAAE 500

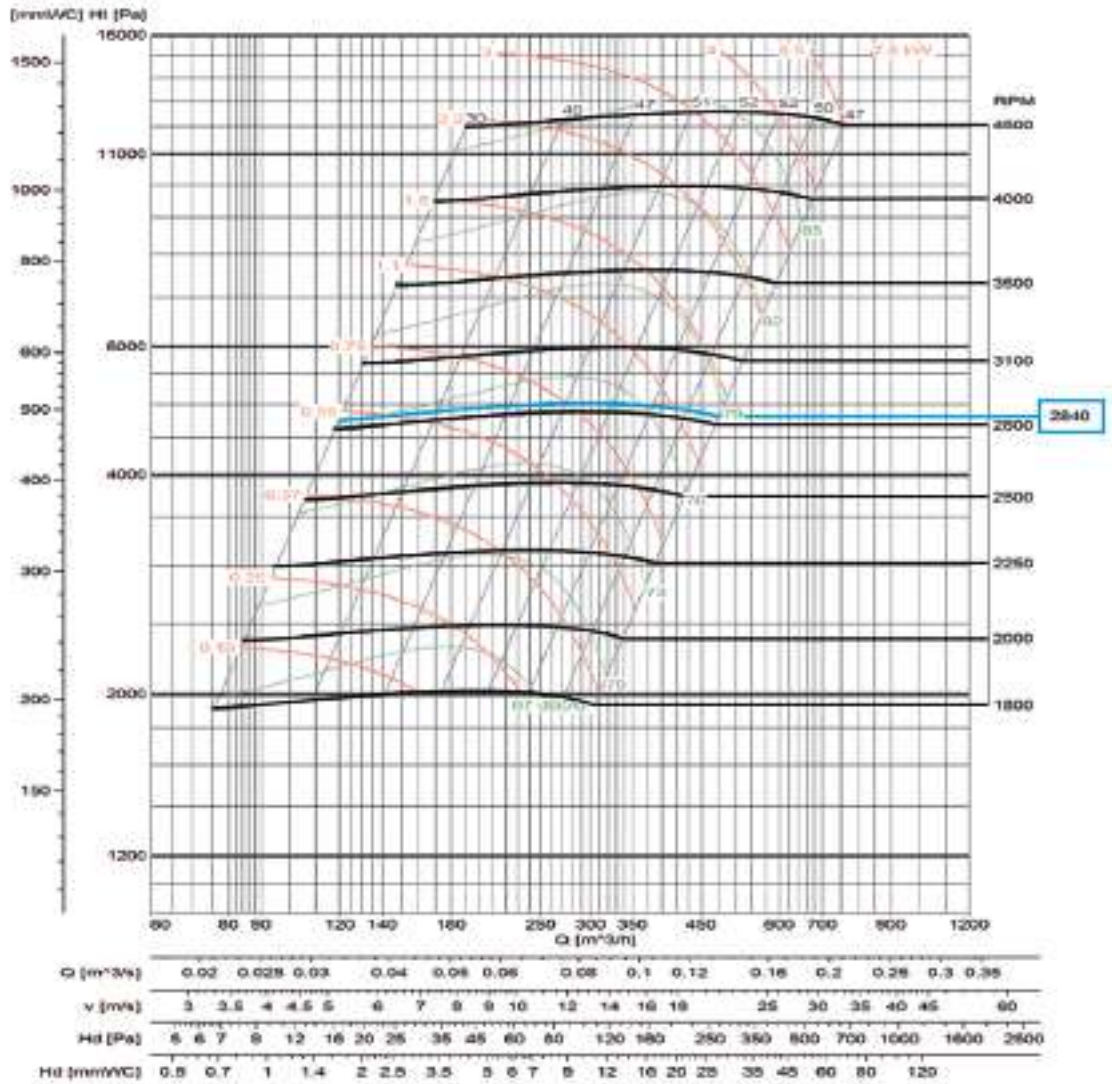

Margen sobre el caudal $\pm 5\%$
 Margen del nivel sonoro $+3...5\text{db}$
 Margen kW absorbidos $\pm 3\%$

Características en impulsión.

Rpm

Características para:
 sistema 4 y 5 en motor
 directo con 2/4/6/8 polos
 según modelo.

Curvas Características

CAAE 630

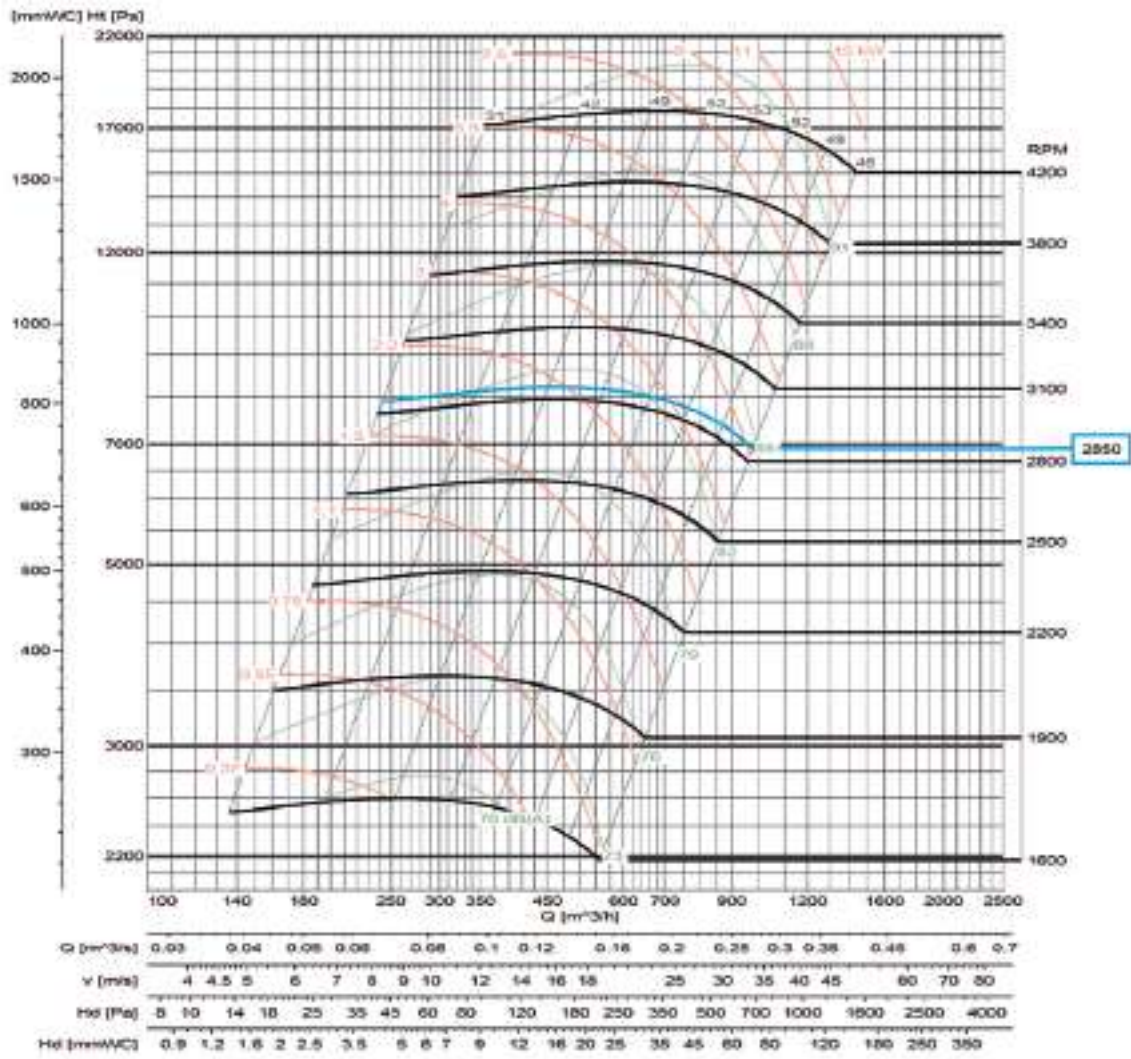

LARGE SERIES

Margen sobre el caudal ± 5 %
 Margen del nivel sonoro +3...5db
 Margen kW absorbidos ± 3%

Características en impulsión.

Rpm

Características para:
 sistema 4 y 5 en motor
 directo con 2/4/6/8 polos
 según modelo.

Curvas Características

CAAE 710

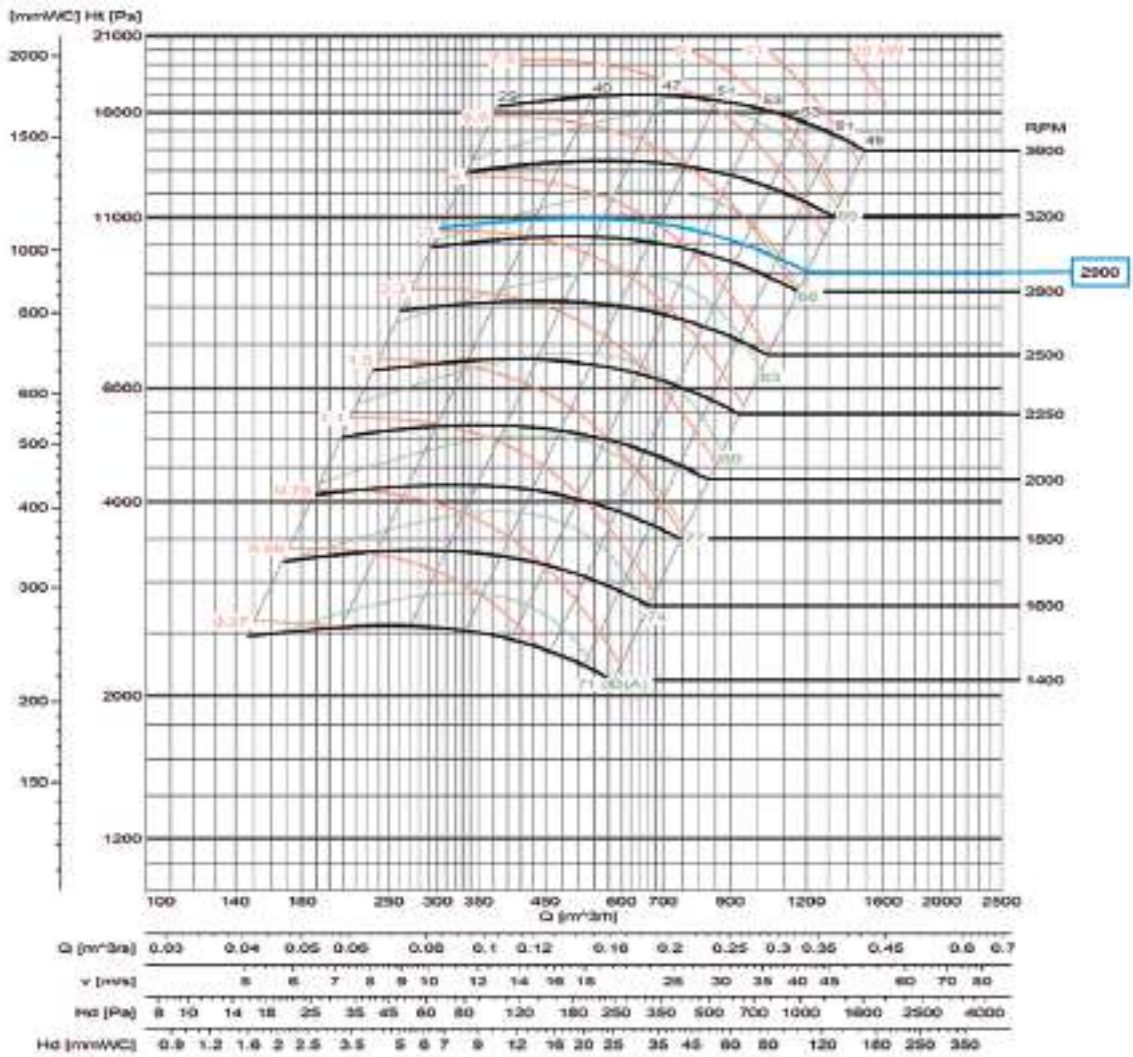

Margen sobre el caudal $\pm 5\%$
 Margen del nivel sonoro $+3...5\text{db}$
 Margen kW absorbidos $\pm 3\%$

Características en impulsión.

Rpm

Características para:
 sistema 4 y 5 en motor
 directo con 2/4/6/8 polos
 según modelo.

Curvas Características

CAAE 800

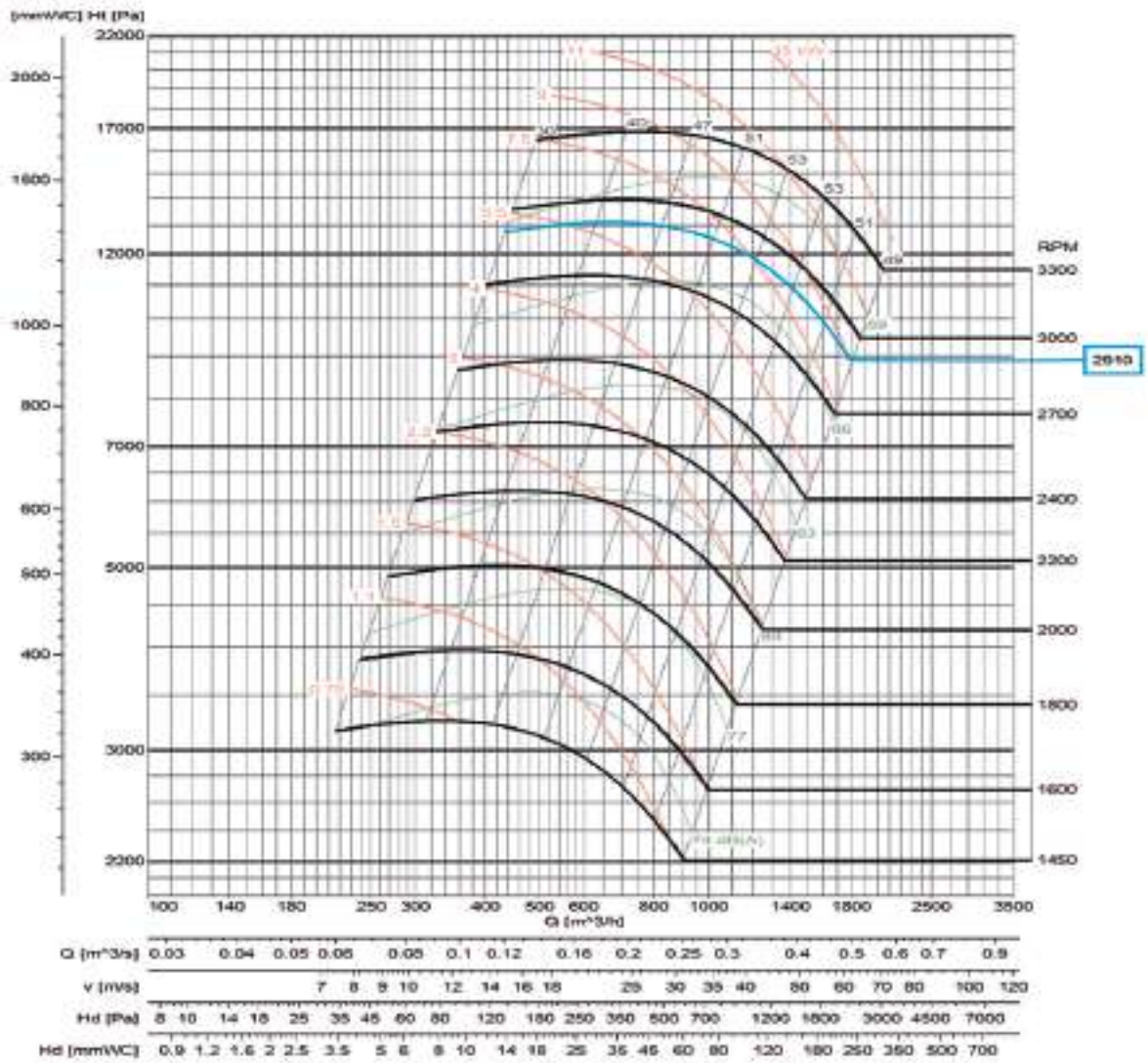

LARGE SERIES

Margen sobre el caudal ± 5 %
 Margen del nivel sonoro +3...5db
 Margen kW absorbidos ± 3%

Características en impulsión.

Rpm

Características para:
 sistema 4 y 5 en motor
 directo con 2/4/6/8 polos
 según modelo.

Curvas Características

CAAE 900

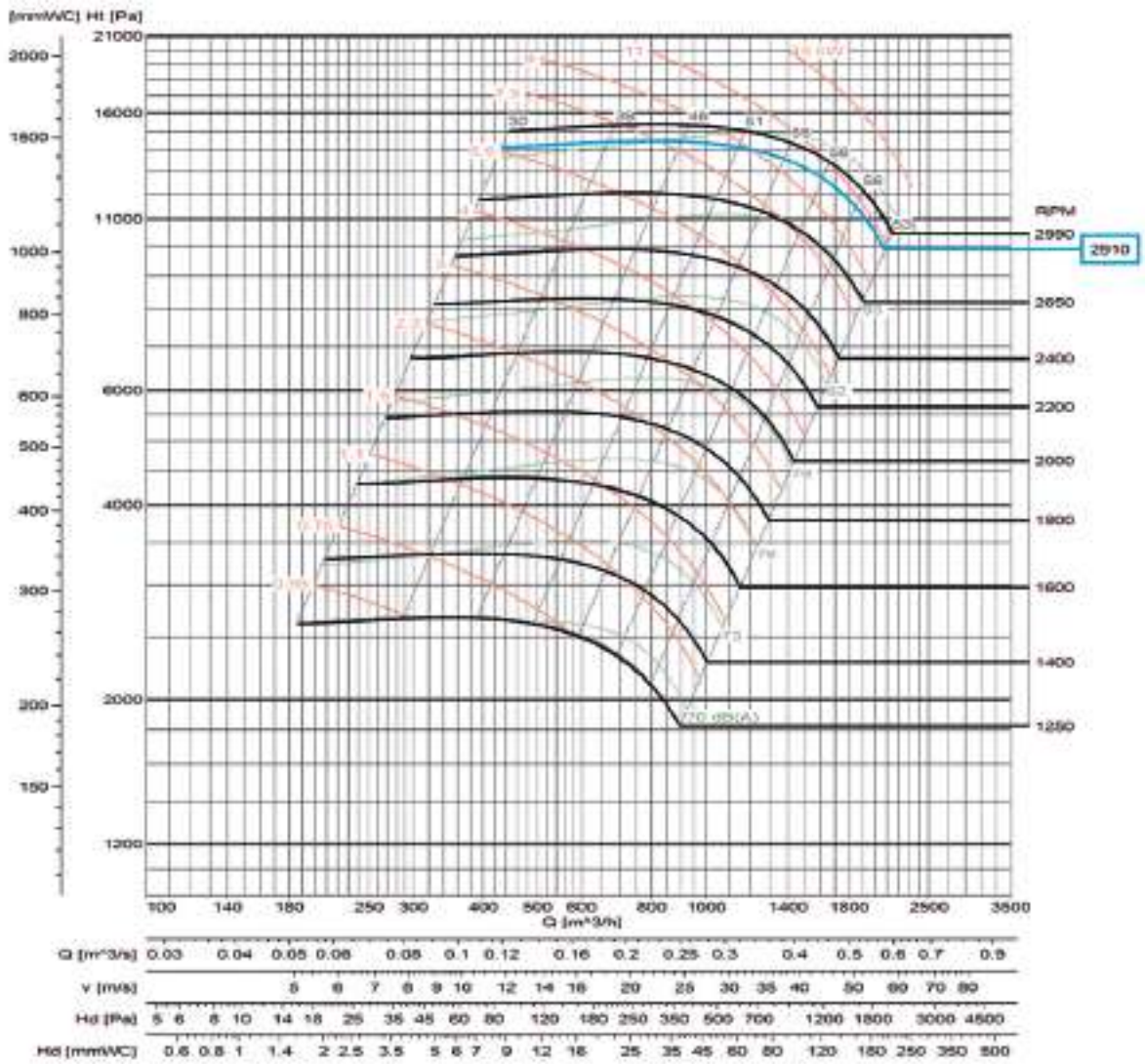

Margen sobre el caudal ± 5 %
 Margen del nivel sonoro +3...5db
 Margen kW absorbidos ± 3%

Características en impulsión.

Rpm

Características para:
 sistema 4 y 5 en motor
 directo con 2/4/6/8 polos
 según modelo.

Dimensiones mm

CAAE 400...900

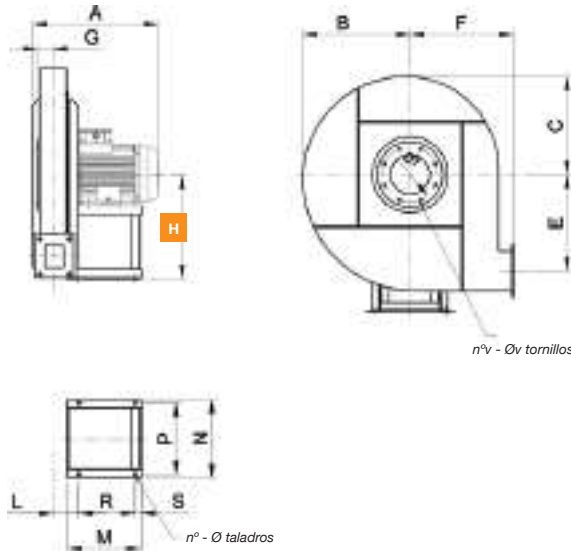

BOCA DE IMPULSIÓN

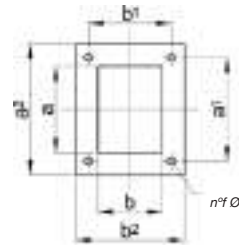

ORIENTACIONES

H0	H1	H2	H3	H4	H5	H6	H7
RD0	RD45	RD90	RD135	RD180	RD225	RD270	RD315
LG0	LG45	LG90	LG135	LG180	LG225	LG270	LG315

H * La medida de la cota H (distancia entre el suelo y el eje) varía según las orientaciones

MOD.	FRAME	A*	B	C	E	F	G	HO-1-2-3	H4-5	H6-7	L	M*	N	P	R*
CAAE 400/B	71 A/2	320	260	250	220	250	42	300	250	300	87	190	244	220	115
CAAE 400/B	71 B/2	320	260	250	220	250	42	300	250	300	87	190	244	220	115
CAAE 400/A	71 B/2	320	260	250	220	250	42	300	250	300	87	190	244	220	115
CAAE 400/A	80 A/2	345	260	250	220	250	42	300	250	300	87	190	244	220	115
CAAE 500/B	80 A/2	345	320	310	280	300	42	355	300	355	87	190	244	220	115
CAAE 500/B	80 B/2	345	320	310	280	300	42	355	300	355	87	190	244	220	115
CAAE 500/A	80 B/2	345	320	310	280	300	42	355	300	355	87	190	244	220	115
CAAE 500/A	90 S/2	360	320	310	280	300	42	355	300	355	87	215	269	245	140
CAAE 630/B	90 S/2	370	375	365	330	355	50	425	355	425	92	215	269	245	140
CAAE 630/B	90 L/2	395	375	365	330	355	50	425	355	425	92	215	269	245	140
CAAE 630/A	90 L/2	395	375	365	330	355	50	425	355	425	92	215	269	245	140
CAAE 630/A	100 LA/2	425	375	365	330	355	50	425	355	425	92	260	312	280	185
CAAE 710/B	100 LA/2	425	425	410	380	400	50	475	400	475	92	260	312	280	185
CAAE 710/B	112 M/2	425	425	410	380	400	50	475	400	475	92	260	312	280	185
CAAE 710/A	112 M/2	425	425	410	380	400	50	475	400	475	92	260	312	280	185
CAAE 710/A	132 SA/2	515	425	410	380	400	50	475	400	475	92	320	342	310	245
CAAE 800/A	132 SA/2	515	475	460	430	450	50	530	450	530	92	320	342	310	245
CAAE 800/A	132 SB/2	515	475	460	430	450	50	530	450	530	92	320	342	310	245
CAAE 800/A	132 MB/2	540	475	460	430	450	50	530	450	530	92	320	342	310	245
CAAE 900/A	160 MA/2	550	570	545	530	525	55	630	525	630	98	320	342	310	245
CAAE 900/A	160 MA/2	595	570	545	530	525	55	630	525	630	98	425	440	400	345

MOD.	BOCA IMPULSIÓN														kg	WD ²
	S	n°	Φ	d ¹	n°v	Φv	a	b	a ¹	b ¹	a ²	b ²	n°f	Φf		
CAAE 400/B	25	4	10	182	8	M6	94	68	112	90	150	128	4	10	28	0,3
CAAE 400/B	25	4	10	182	8	M6	94	68	112	90	150	128	4	10	30	0,3
CAAE 400/A	25	4	10	182	8	M6	94	68	112	90	150	128	4	10	31	0,4
CAAE 400/A	25	4	10	182	8	M6	94	68	112	90	150	128	4	10	35	0,4
CAAE 500/B	25	4	10	182	8	M6	94	68	112	90	150	128	4	10	40	0,8
CAAE 500/B	25	4	10	182	8	M6	94	68	112	90	150	128	4	10	41	0,8
CAAE 500/A	25	4	10	182	8	M6	94	68	112	90	150	128	4	10	42	1,2
CAAE 500/A	25	4	10	182	8	M6	94	68	112	90	150	128	4	10	50	1,2
CAAE 630/B	25	4	10	200	8	M6	105	77	125	100	165	137	4	10	60	2
CAAE 630/B	25	4	10	200	8	M6	105	77	125	100	165	137	4	10	62	2
CAAE 630/A	25	4	10	200	8	M6	105	77	125	100	165	137	4	10	65	3,2
CAAE 630/A	25	4	12	200	8	M6	105	77	125	100	165	137	4	10	80	3,2
CAAE 710/B	25	4	12	200	8	M6	105	77	125	100	165	137	4	10	95	4,7
CAAE 710/B	25	4	12	200	8	M6	105	77	125	100	165	137	4	10	100	4,7
CAAE 710/A	25	4	12	200	8	M6	105	77	125	100	165	137	4	10	105	6
CAAE 710/A	25	4	12	200	8	M6	105	77	125	100	165	137	4	10	125	6
CAAE 800/A	25	4	12	200	8	M6	105	77	125	100	165	137	4	10	145	9,5
CAAE 800/A	25	4	12	200	8	M6	105	77	125	100	165	137	4	10	150	9,5
CAAE 800/A	25	4	12	200	8	M6	105	77	125	100	165	137	4	10	160	9,5
CAAE 900/A	25	4	12	219	8	M6	117	87	140	112	177	147	4	10	190	15
CAAE 900/A	30	4	14	219	8	M6	117	87	140	112	177	147	4	10	220	15

(*) Para construcciones a "ALTA TEMP." cotas "A-M-R" + 50 mm.
(kg) Peso ventilador con motor.
WD² = Momento de inercia del rodete, expresado en Kg x m²

Para obtener las dimensiones de los sistemas 1, 9 y 12 consultar a nuestro equipo técnico.

LARGE SERIES

Accesorios

Contrabrida aspiración

n° - Ø taladros

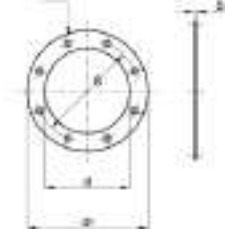

MOD.	d	d¹	d²	n°	Φ	s	kg
CAAE 400	145	182	215	8	9	4	0,6
CAAE 500	145	182	215	8	9	4	0,6
CAAE 630	165	200	235	8	9	4	0,65
CAAE 710	165	200	235	8	9	4	0,65
CAAE 800	165	200	235	8	9	4	0,65
CAAE 900	185	219	255	8	9	4	0,75

Junta anti vibratoria en aspiración

n° - Ø taladros

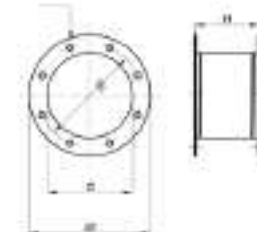

MOD.	d	d¹	d²	n°	Φ	H	kg
CAAE 400	145	182	215	8	9	200	1,5
CAAE 500	145	182	215	8	9	200	1,5
CAAE 630	165	200	235	8	9	200	1,6
CAAE 710	165	200	235	8	9	200	1,6
CAAE 800	165	200	235	8	9	200	1,6
CAAE 900	185	219	255	8	9	200	1,7

Contrabrida impulsión

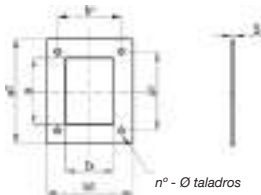

n° - Ø taladros

MOD.	a	b	a¹	b¹	a²	b²	n°	Φ	s	kg
CAAE 400	94	68	112	90	150	128	4	10	4	0,4
CAAE 500	94	68	112	90	150	128	4	10	4	0,4
CAAE 630	105	77	125	100	165	137	4	10	4	0,45
CAAE 710	105	77	125	100	165	137	4	10	4	0,45
CAAE 800	105	77	125	100	165	137	4	10	4	0,45
CAAE 900	117	87	140	112	177	147	4	10	4	0,5

Junta anti vibratoria en impulsión

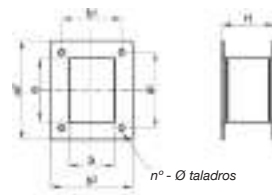

n° - Ø taladros

MOD.	a	b	a¹	b¹	a²	b²	n°	Φ	H	kg
CAAE 400	94	68	112	90	150	128	4	10	200	1
CAAE 500	94	68	112	90	150	128	4	10	200	1
CAAE 630	105	77	125	100	165	137	4	10	200	1,1
CAAE 710	105	77	125	100	165	137	4	10	200	1,1
CAAE 800	105	77	125	100	165	137	4	10	200	1,1
CAAE 900	117	87	140	112	177	147	4	10	200	1,2

Red protección en aspiración

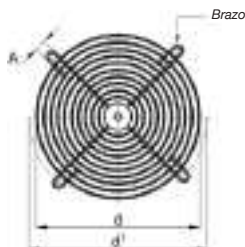

Brazo

MOD.	d	d¹	A	n°	kg
CAAE 400	145	182	9	4	0,13
CAAE 500	145	182	9	4	0,13
CAAE 630	165	200	9	4	0,15
CAAE 710	165	200	9	4	0,15
CAAE 800	165	200	9	4	0,15
CAAE 900	185	219	9	4	0,18

Silenciadores circulares

Los silenciadores se utilizan para bajar el nivel sonoro en instalaciones de acondicionamiento o ventilación, fabricados en acero cincado

- Bajo demanda: otras construcciones en diferentes materiales.



øD	øE	L	øI	F	øM	øD	øE	L	øI	F	øM
315	515	ØD,1.5ØD, 2ØD	355	8	M8	900	1100	ØD,1.5ØD, 2ØD	970	16	M10
355	555	ØD,1.5ØD, 2ØD	395	8	M8	1000	1200	ØD,1.5ØD, 2ØD	1070	16	M10
400	600	ØD,1.5ØD, 2ØD	450	8	M8	1120	1320	ØD,1.5ØD, 2ØD	1190	20	M10
450	650	ØD,1.5ØD, 2ØD	500	8	M8	1250	1450	ØD,1.5ØD, 2ØD	1320	20	M10
500	700	ØD,1.5ØD, 2ØD	560	12	M8	1400	1600	ØD,1.5ØD, 2ØD	1470	20	M10
560	760	ØD,1.5ØD, 2ØD	620	12	M8	1500	1700	ØD,1.5ØD, 2ØD	1570	20	M10
630	830	ØD,1.5ØD, 2ØD	690	12	M8	1600	1800	ØD,1.5ØD, 2ØD	1680	24	M14
710	910	ØD,1.5ØD, 2ØD	770	16	M8	1700	1900	ØD,1.5ØD, 2ØD	1780	24	M14
800	1000	ØD,1.5ØD, 2ØD	860	16	M8	1800	2000	ØD,1.5ØD, 2ØD	1880	24	M14

Amortiguadores

TIPO 1

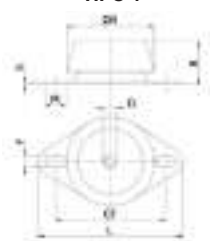

TIPO 2

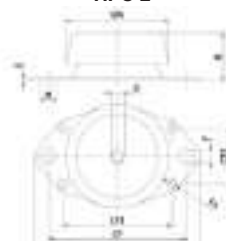

MOD.	MODELO AMORTIGUADORES	TIPO	øA	B	D	CF	CF1	CF2	F	øF1	L	M	S
CAAE 400	CF 623110	1	67	33...34	10	76,5	-	-	9	-	90,5	16	2
CAAE 500	CF 623110	1	67	33...34	10	76,5	-	-	9	-	90,5	16	2
CAAE 630	CF 623110	1	67	33...34	10	76,5	-	-	9	-	90,5	16	2
CAAE 710	CF 623110	1	67	33...34	10	76,5	-	-	9	-	90,5	16	2
CAAE 800	CF 924512	2	92	44...45	12	120	98	50	10,5	8,5	130	15,5	2,5
CAAE 900	CF 924512	2	92	44...45	12	120	98	50	10,5	8,5	130	15,5	2,5

MOTOR DIRECTO

CAAF

Ventiladores centrífugos de alta presión y simple aspiración de gran robustez con envolvente y turbina en chapa de acero

Diseñados para aire limpio y polvoriento



* Las imágenes son solo a nivel ilustrativo, el producto puede variar en función del tamaño, especificaciones y posición.

Ventilador:

- Envolvente en chapa de acero.
- Turbina a reacción en chapa de acero de gran robustez, especialmente diseñados para aire limpio y polvoriento.
- Motor directamente acoplado.
- Con trampilla de inspección y limpieza a partir del tamaño 560.
- Todas las carcasas soldadas en continuo.

Motor:

- Motores con eficiencia IE3 para potencias iguales o superiores a 0,75 kW, excepto monofásicos, 2 velocidades y 8 polos.
- Motores clase F con rodamientos a bolas. Protección IP55.
- Trifásicos 230/400 V 50 Hz (hasta 4 kW) y 400/690 V 50 Hz (potencias superiores a 4 kW).
- Temperatura máxima del aire a transportar: -25 °C +90 °C.

Acabado:

- Anticorrosivo en resina de poliéster polimerizada a 190 °C, previo desengrase con tratamiento nanotecnológico libre de fosfatos.

Bajo demanda:

- Bobinados especiales para diferentes tensiones.
- Ventilador preparado para transportar aire hasta +150 °C.
- Ejecuciones especiales para temperaturas +300 °C.
- Ventilador en acero inoxidable.
- Certificación ATEX Categoría 2.
- Acoplamiento elástico sistema 8.

Formas constructivas motor directo

SISTEMA 4

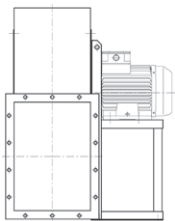

Accionamiento directo, turbina montada en el eje motor, montado sobre la sileta.

SISTEMA 5

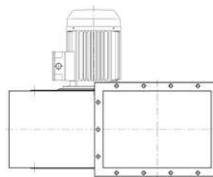

Accionamiento directo, turbina montada en el eje motor, motor de brida montado sobre la carcasa del ventilador.

SISTEMA 8

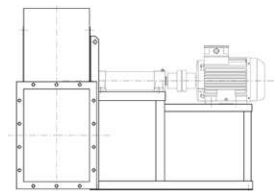

Accionamiento por acoplamiento elástico, turbina montada en el eje soporte, montado al motor mediante acoplamiento elástico. Todo montado conjuntamente sobre la sileta ventilador.

Orientaciones

RD 0 RD45 RD90 RD135 RD180 RD225 RD270 RD315

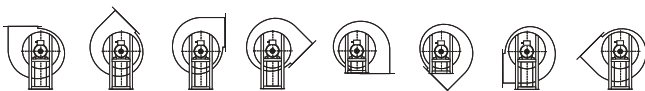

LG 0 LG45 LG90 LG135 LG180 LG225 LG270 LG315

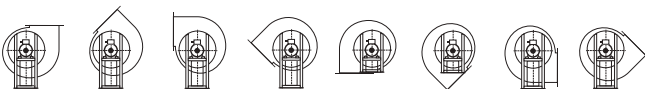

MOTOR A TRANSMISIÓN

CAAF-X

Ventiladores de alta presión accionados a transmisión, equipados con motor eléctrico, conjunto de poleas, correas y protectores normalizados según norma ISO-13857
Diseñados para aire limpio y polvoriento



* Las imágenes son solo a nivel ilustrativo, el producto puede variar en función del tamaño, especificaciones y posición.



Ventilador:

- Envoltente en chapa de acero.
- Turbina a reacción en chapa de acero de gran robustez, especialmente diseñados para aire limpio y polvoriento.
- Motor montado sobre bancada general.
- Con trampilla de inspección y limpieza a partir del tamaño 560.
- Todas las carcasas soldadas en continuo.

Motor:

- Motores con eficiencia IE3.
- Motores clase F con rodamientos a bolas. Protección IP55.
- Trifásicos 230/400 V 50 Hz (hasta 4 kW) y 400/690 V 50 Hz (potencias superiores a 4 kW).
- Temperatura máxima del aire a transportar: -25 °C +90 °C.

Acabado:

- Anticorrosivo en resina de poliéster polimerizada a 190 °C, previo desengrase con tratamiento nanotecnológico libre de fosfatos.

Bajo demanda:

- Bobinados especiales para diferentes tensiones.
- Ventilador preparado para transportar aire hasta +300 °C.
- Ventilador en acero inoxidable.
- Certificación ATEX Categoría 2.
- Acoplamiento elástico sistema 8.

Formas constructivas motor a transmisión

SISTEMA 12

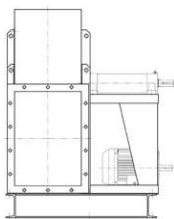

Accionamiento a transmisión, igual al SISTEMA 1, con el motor y ventilador montados en la bancada común. Posiciones de motor "W" o "Z" y excepcionalmente "X" o "Y".

SISTEMA 9

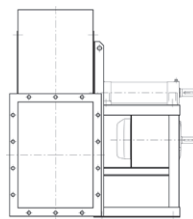

Accionamiento a transmisión, igual al SISTEMA 1, con el motor montado en el lateral de la silleta, en posición "W" o "Z".

SISTEMA 1

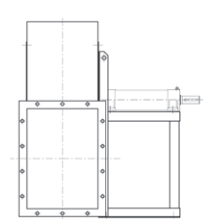

Accionamiento a transmisión, turbina montada en el eje soporte. Soporte montado sobre la silleta.

Orientaciones

RD 0 RD45 RD90 RD135 RD180 RD225 RD270 RD315

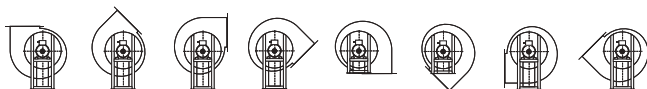

LG 0 LG45 LG90 LG135 LG180 LG225 LG270 LG315

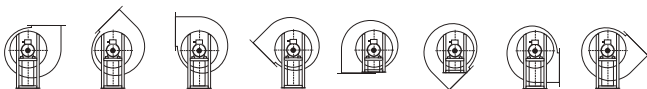

SELECCIÓN RÁPIDA SISTEMA 4

Características en impulsión

Modelo	Frame	kW ass	kW inst.	r.p.m.	dB	V m³/s																					
						0,167	0,183	0,2	0,23	0,267	0,3	0,33	0,367	0,416	0,467	0,516	0,58	0,67									
						Pt kgf/m²=mmH₂O																					
CAAF 475/A	90 L/2	2	2,2	2840	76	440	440	440	440	430	425	420															
CAAF 475/A	100 LA/2	2,7	3	2850	76							420	410														
CAAF 560/B	112 M/2	3,7	4	2860	80							560	560	560	560	560											
CAAF 560/B	132 SA/2	5	5,5	2900	80									550	540	530	510										
CAAF 560/A	112 M/2	3,7	4	2860	82							660	660	655	650	645											
CAAF 560/A	132 SA/2	5	5,5	2900	82									640	630	625	600										
CAAF 630/B	132 SA/2	5	5,5	2900	83							760	760	760	755	750	745										
CAAF 630/B	132 SB/2	7	7,5	2900	83											740	730	720									
CAAF 630/A	132 SB/2	7	7,5	2900	85							820	820	820	825	825	820	820	815								
CAAF 630/A	160 MA/2	8,6	11	2910	85													800									
CAAF 710/B	132 SB/2	7,2	7,5	2900	86							950	955	960	960	960											
CAAF 710/B	160 MA/2	10	11	2910	88													950									
CAAF 710/A	160 MA/2	10	11	2910	88													1050	1050	1050	1050	1050					
CAAF 710/A	160 MB/2	14,2	15	2930	88																			1050			
CAAF 800/B	160 MB/2	14,5	15	2930	90													1210	1215	1220	1220	1220					
CAAF 800/A	160 MB/2	14	15	2930	90													1350	1355	1360	1360						
CAAF 800/A	160 L/2	18	18,5	2940	90																			1365			
CAAF 900/B	180 M/2	20	22	2950	93															1570	1570	1580					
CAAF 900/A	200 LA/2	28	30	2950	94																			1730	1735		

Modelo	Frame	kW ass	kW inst.	r.p.m.	dB	V m³/s												
						0,75	0,83	0,93	1,05	1,2	1,33	1,5	1,67	1,87	2,08	2,33		
						Pt kgf/m²=mmH₂O												
CAAF 630/B	132 SB/2	7	7,5	2900	83	710												
CAAF 630/A	160 MA/2	8,6	11	2910	85	790												
CAAF 710/B	160 MA/2	10	11	2910	88	940												
CAAF 710/B	160 MB/2	8,7	15	2930	88			920	905	880								
CAAF 710/A	160 MB/2	14,2	15	2930	88	1045	1045	1040										
CAAF 710/A	160 L/2	18	18,5	2940	88							1030	1020					
CAAF 800/B	160 MB/2	14,5	15	2930	90	1220												
CAAF 800/B	160 L/2	18	18,5	2940	90			1210	1205	1200								
CAAF 800/B	180 M/2	21,5	22	2950	90							1190	1180					
CAAF 800/A	160 L/2	18	18,5	2940	90	1365	1365											
CAAF 800/A	180 M/2	21	22	2950	93			1360	1360									
CAAF 800/A	200 LA/2	28,5	30	2950	93							1360	1340	1330	1320			
CAAF 900/B	180 M/2	20	22	2950	93	1580	1580											
CAAF 900/B	200 LA/2	29	30	2950	93							1570	1565	1560				
CAAF 900/B	200 LB/2	36	37	2960	95							1550	1550	1540				
CAAF 900/B	225 M/2	43,5	45	2960	95									1520	1510			
CAAF 900/A	200 LA/2	28	30	2950	94	1740	1740	1740										
CAAF 900/A	200 LB/2	36	37	2960	94							1740	1740					
CAAF 900/A	225 M/2	44	45	2960	96							1730	1725	1720				
CAAF 900/A	250 M/2	53	55	2970	96									1715	1700	1690		

Margen sobre el caudal ±5%.
Margen del nivel sonoro +3...5db.

LARGE SERIES

SELECCIÓN RÁPIDA SISTEMA 4

Características en aspiración

Modelo	Frame	kW ass	kW inst.	r.p.m.	dB	V m ³ /s															
						0,167	0,183	0,2	0,23	0,267	0,3	0,33	0,367	0,416	0,467	0,516	0,58	0,67			
						Pt kgf/m ² =mmH ₂ O															
CAAF 475/A	90 L/2	2	2,2	2840	81	425	425	425	425	415	410	410									
CAAF 475/A	100 LA/2	2,7	3	2850	81								410	410							
CAAF 560/B	112 M/2	3,7	4	2860	85				530	535	535	535	535								
CAAF 560/B	132 SA/2	5	5,5	2900	85									525	515	505	485				
CAAF 560/A	112 M/2	3,7	4	2860	88				625	630	625	620	615								
CAAF 560/A	132 SA/2	5	5,5	2900	88									610	600	595	570				
CAAF 630/B	132 SA/2	5	5,5	2900	89				715	715	715	710	705	700							
CAAF 630/B	132 SB/2	7	7,5	2900	89											695	690	680			
CAAF 630/A	132 SB/2	7	7,5	2900	91				760	760	760	760	760	760	765	760	760				
CAAF 630/A	160 MA/2	8,6	11	2910	91															760	
CAAF 710/B	132 SB/2	7,2	7,5	2900	94					870	875	880	880	880							
CAAF 710/B	160 MA/2	10	11	2910	91															875	
CAAF 710/A	160 MA/2	10	11	2910	94								950	950	950	950	950				
CAAF 710/A	160 MB/2	14,2	15	2930	94															950	
CAAF 800/B	160 MB/2	14,5	15	2930	96									1060	1065	1070	1070	1070			
CAAF 800/A	160 MB/2	14	15	2930	99									1170	1175	1180	1180				
CAAF 800/A	160 L/2	18	18,5	2940	99															1185	
CAAF 900/B	180 M/2	20	22	2950	99											1320	1320	1330			
CAAF 900/A	200 LA/2	28	30	2950	100															1440	1445

Modelo	Frame	kW ass	kW inst.	r.p.m.	dB	V m ³ /s														
						0,75	0,83	0,93	1,05	1,2	1,33	1,5	1,67	1,87	2,08	2,33				
						Pt kgf/m ² =mmH ₂ O														
CAAF 630/B	132 SB/2	7	7,5	2900	89	670														
CAAF 630/A	160 MA/2	8,6	11	2910	91	750	740													
CAAF 710/B	160 MA/2	10	11	2910	91	870														
CAAF 710/B	160 MB/2	8,7	15	2930	91		855	845	820											
CAAF 710/A	160 MB/2	14,2	15	2930	94	945	945	940												
CAAF 710/A	160 L/2	18	18,5	2940	94				930	920										
CAAF 800/B	160 MB/2	14,5	15	2930	96	1070														
CAAF 800/B	160 L/2	18	18,5	2940	96		1060	1060	1060	1060										
CAAF 800/B	180 M/2	21,5	22	2950	96						1055	1050								
CAAF 800/A	160 L/2	18	18,5	2940	99	1185	1185													
CAAF 800/A	180 M/2	21	22	2950	99			1180	1180											
CAAF 800/A	200 LA/2	28,5	30	2950	99					1180	1165	1160	1150							
CAAF 900/B	180 M/2	20	22	2950	99	1330	1330													
CAAF 900/B	200 LA/2	29	30	2950	99									1320	1310	1305				
CAAF 900/B	200 LB/2	36	37	2960	101															
CAAF 900/B	225 M/2	43,5	45	2960	101															
CAAF 900/A	200 LA/2	28	30	2950	100	1450	1450	1450												
CAAF 900/A	200 LB/2	36	37	2960	100				1450	1430										
CAAF 900/A	225 M/2	44	45	2960	102						1435	1430	1420							
CAAF 900/A	250 M/2	53	55	2970	102											1415	1400	1390		

Margen sobre el caudal ±5%.
Margen del nivel sonoro +3...5db.

Curvas Características

CAAF 475

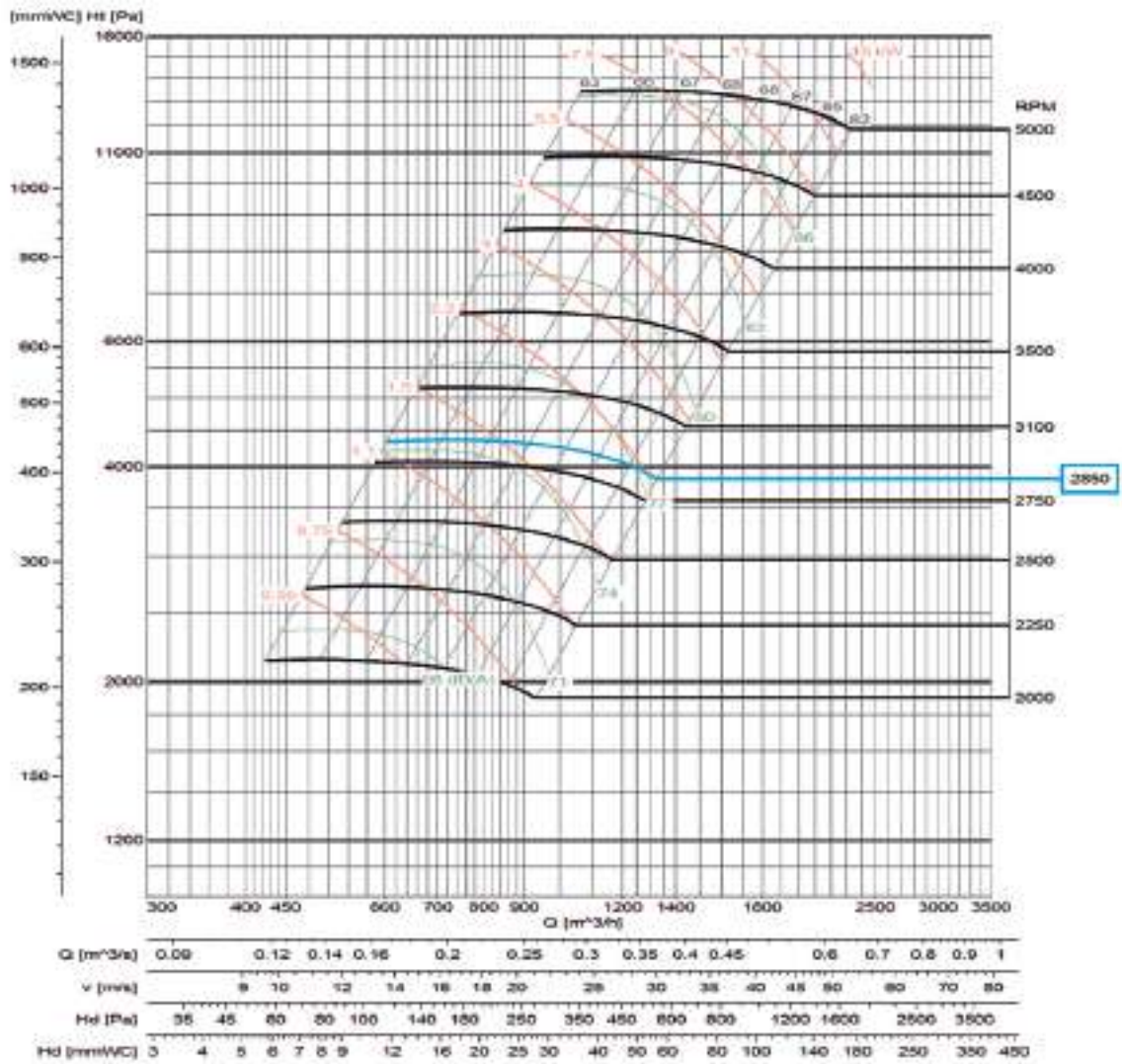

LARGE SERIES

Margen sobre el caudal ± 5 %
 Margen del nivel sonoro +3...5db
 Margen kW absorbidos ± 3%

Características en impulsión.

Rpm

Características para:
 sistema 4 y 5 en motor
 directo con 2/4/6/8
 según modelo.

Curvas Características

CAAF 560

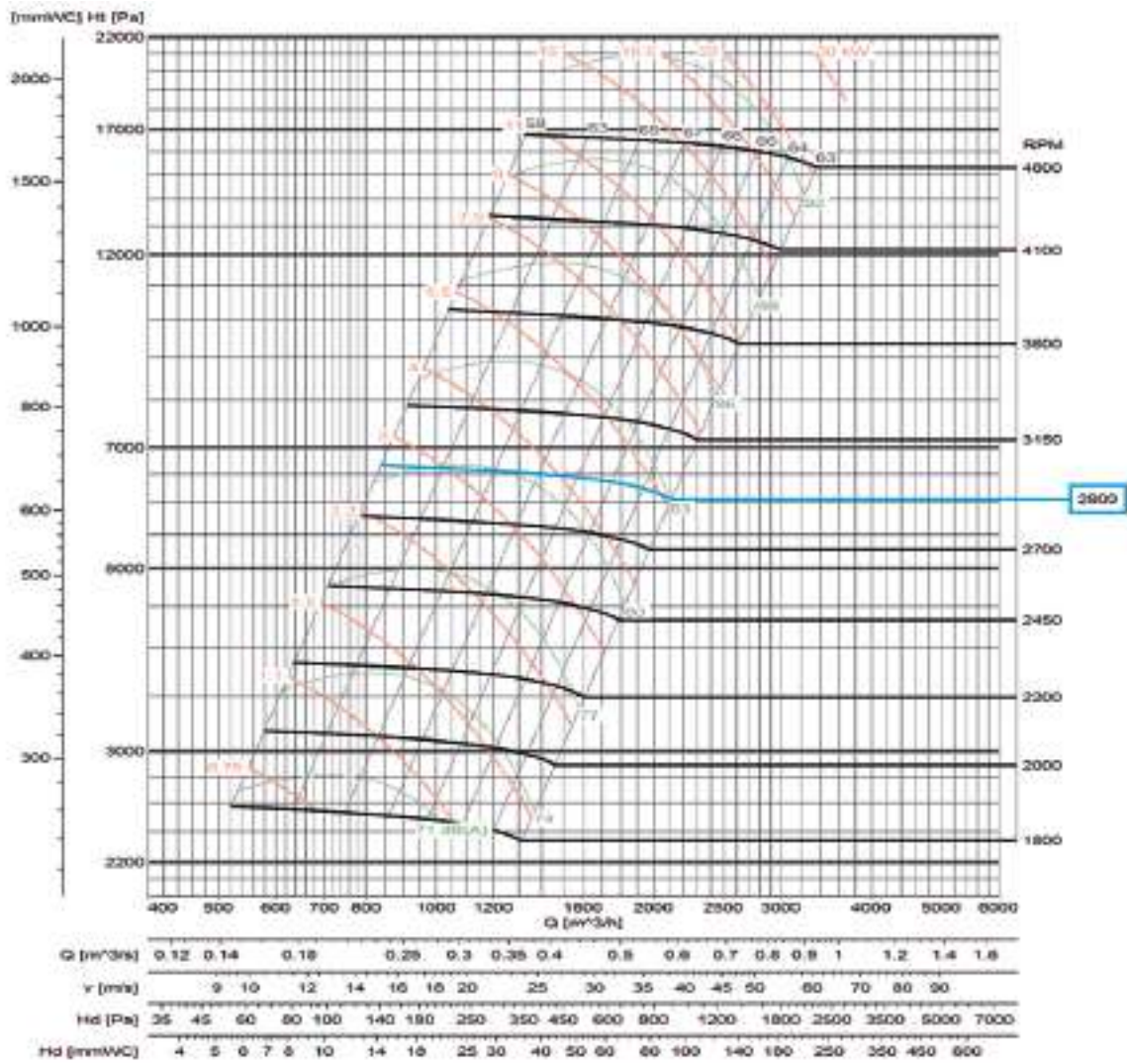

Margen sobre el caudal $\pm 5\%$
 Margen del nivel sonoro $+3...5\text{db}$
 Margen kW absorbidos $\pm 3\%$

Características en impulsión.

Rpm

Características para:
 sistema 4 y 5 en motor
 directo con 2/4/6/8 polos
 según modelo.

Curvas Características

CAAF 630

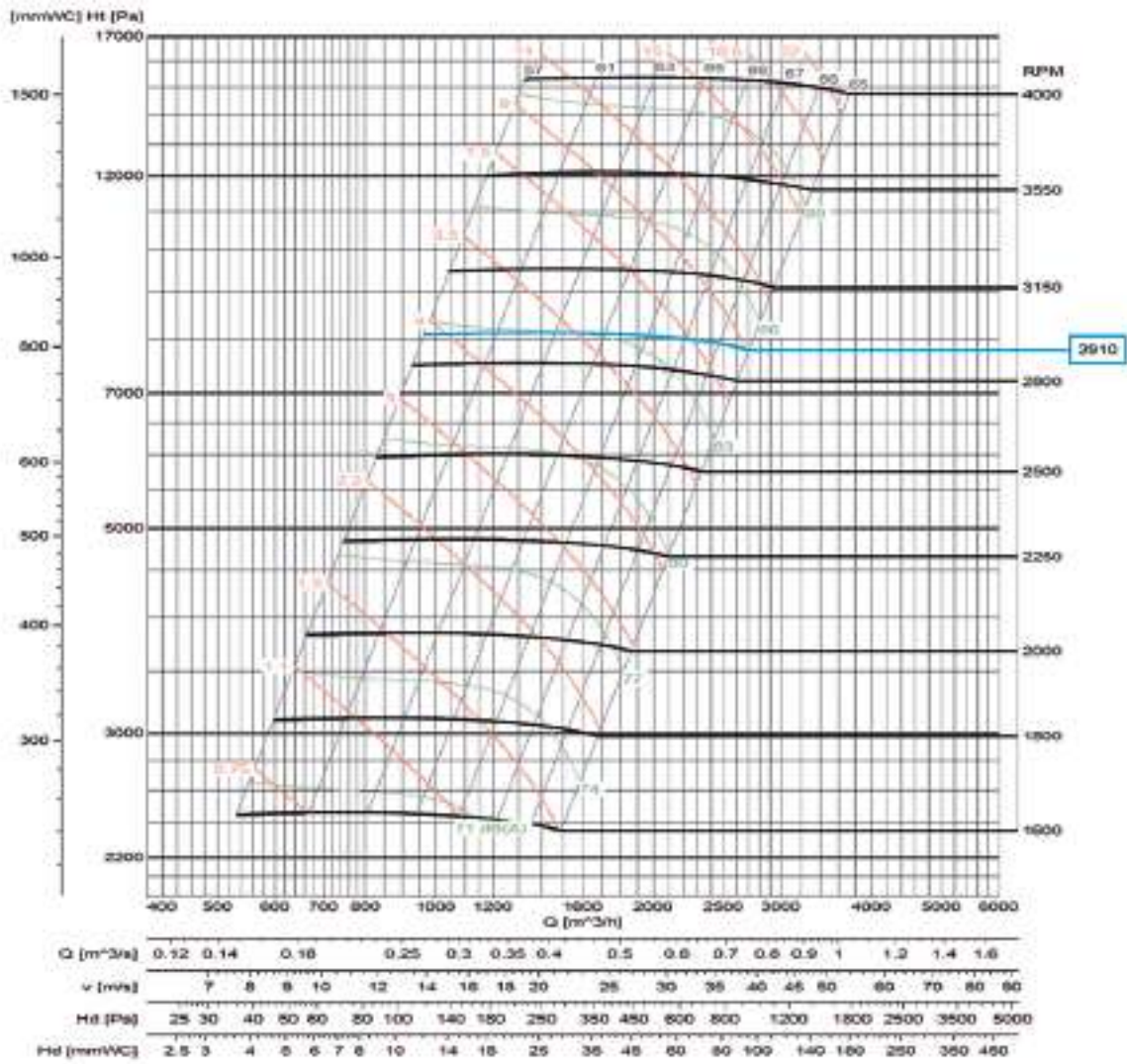

LARGE SERIES

Margen sobre el caudal ± 5 %
 Margen del nivel sonoro +3...5db
 Margen kW absorbidos ± 3%

Características en impulsión.

Rpm

Características para:
 sistema 4 y 5 en motor
 directo con 2/4/6/8 polos
 según modelo.

Curvas Características

CAAF 710

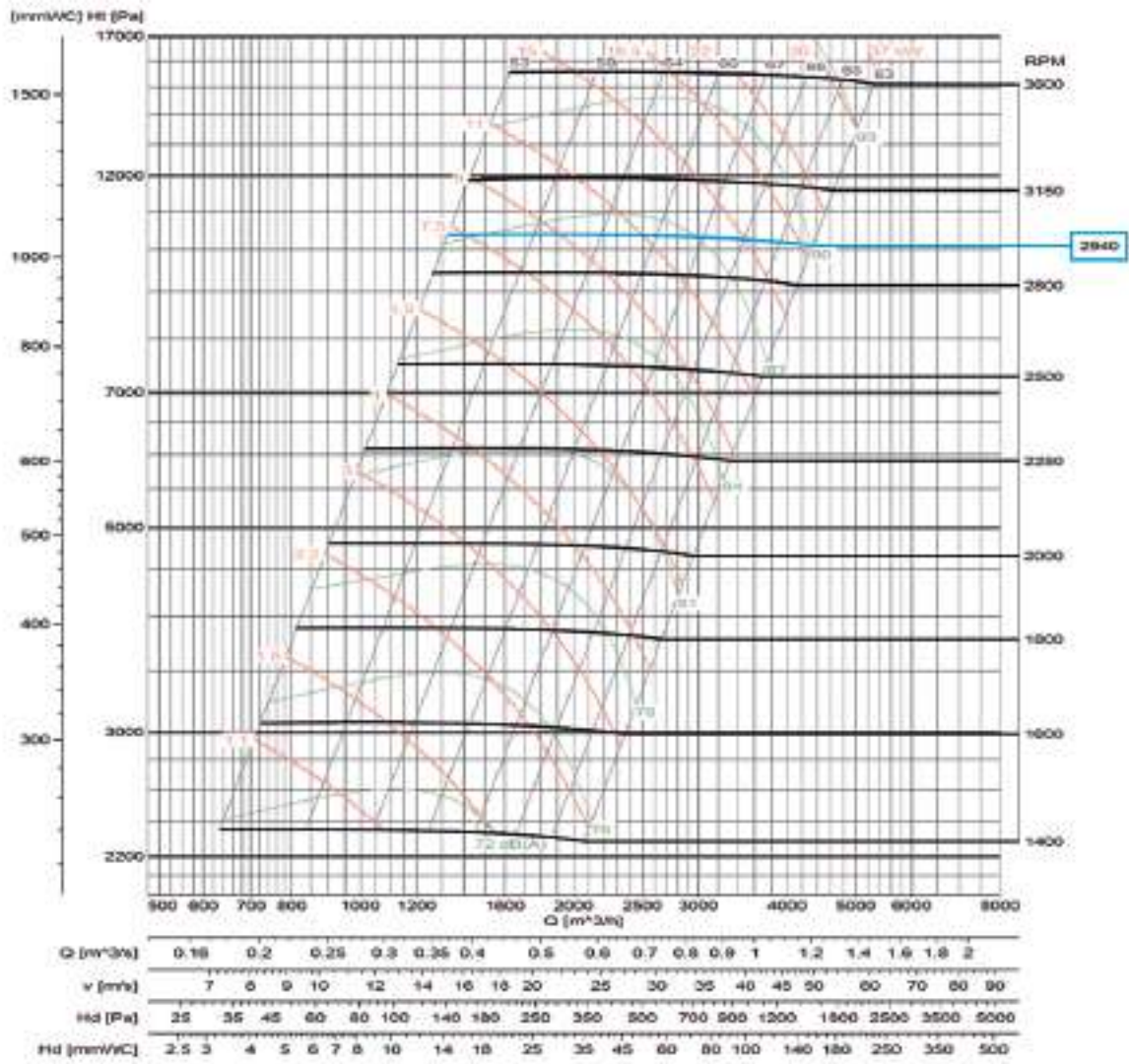

Margen sobre el caudal ± 5 %
 Margen del nivel sonoro +3...5db
 Margen kW absorbidos ± 3%

Características en impulsión.

Rpm

Características para:
 sistema 4 y 5 en motor
 directo con 2/4/6/8 polos
 según modelo.

Curvas Características

CAAF 800

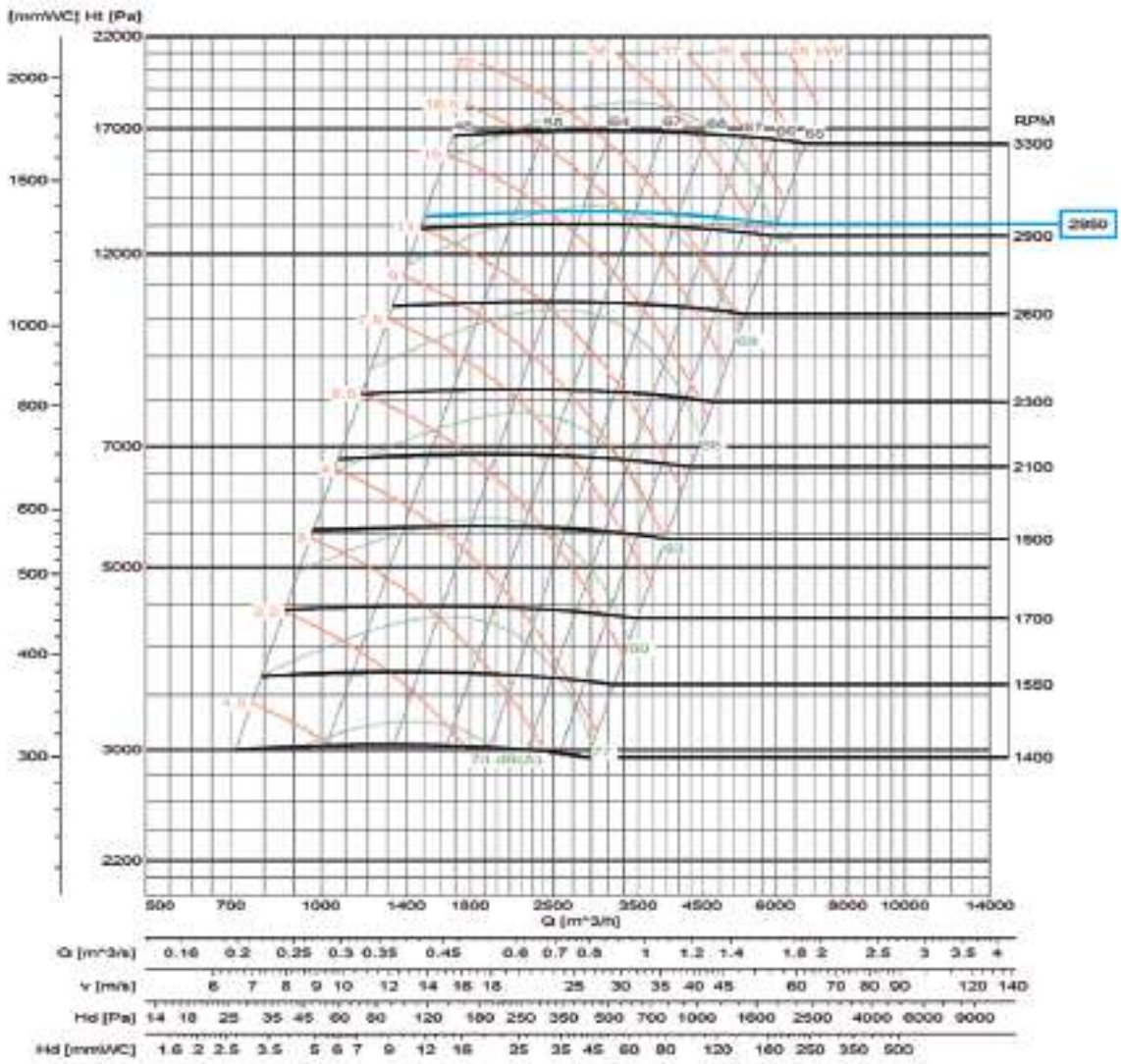

LARGE SERIES

Margen sobre el caudal ± 5 %
 Margen del nivel sonoro +3...5db
 Margen kW absorbidos ± 3%

Características en impulsión.

Rpm

Características para:
 sistema 4 y 5 en motor
 directo con 2/4/6/8 polos
 según modelo.

Curvas Características

CAAF 900

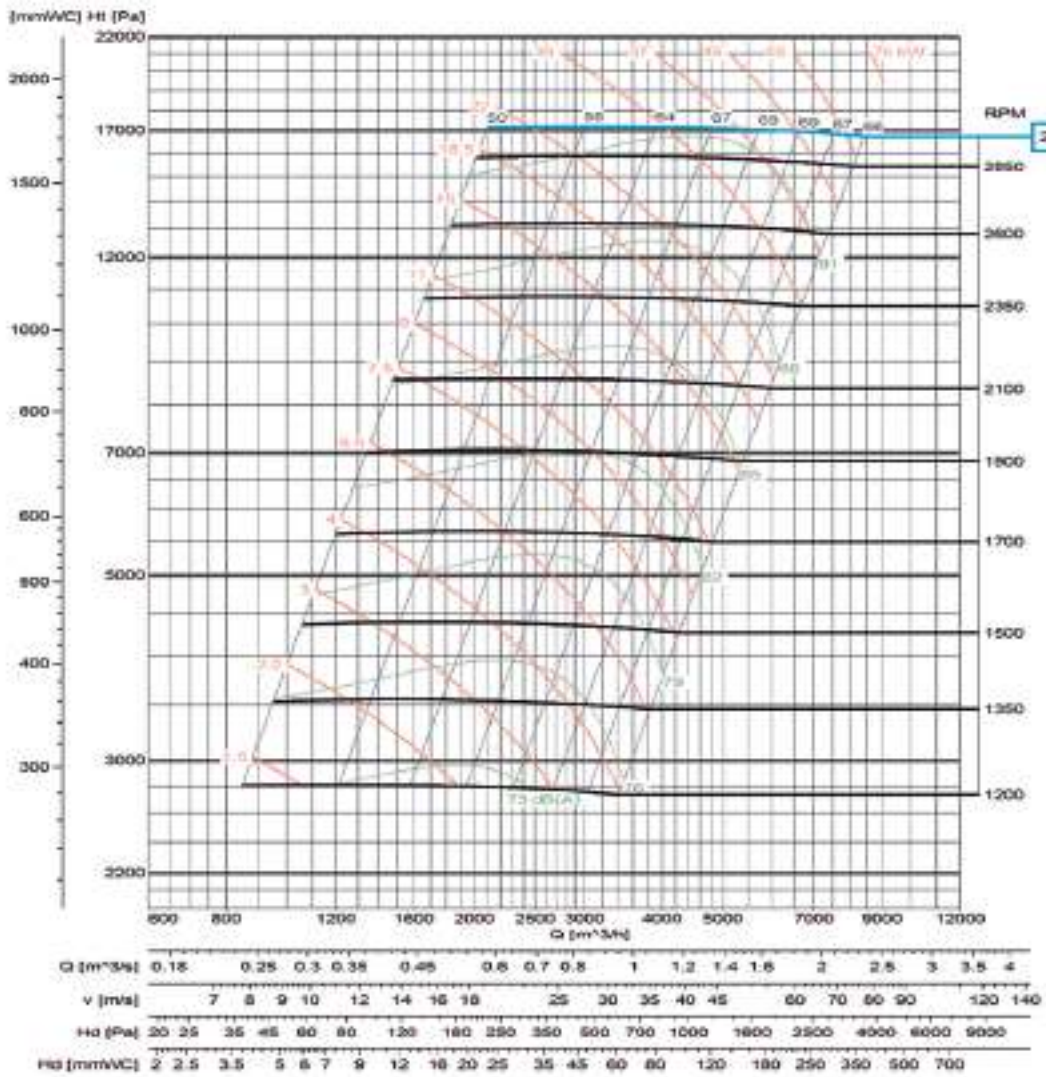

Margen sobre el caudal $\pm 5\%$
 Margen del nivel sonoro $+3...5\text{db}$
 Margen kW absorbidos $\pm 3\%$

Características en impulsión.

Rpm

Características para:
 sistema 4 y 5 en motor
 directo con 2/4/6/8
 según modelo.

Dimensiones mm

SISTEMA
4

CAAF 475...900

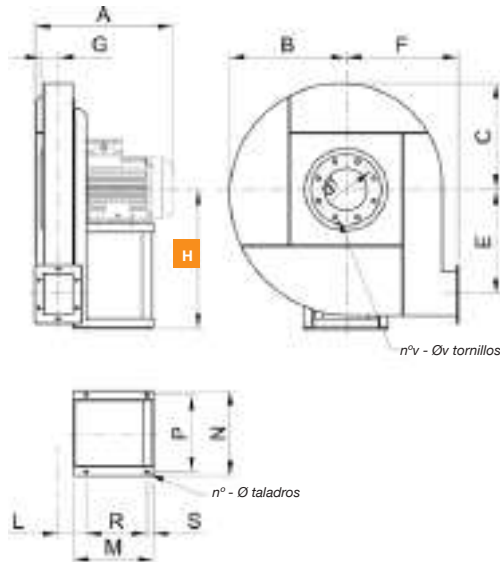

ORIENTACIONES

H0	H1	H2	H3	H4	H5	H6	H7
RD0	RD45	RD90	RD135	RD180	RD225	RD270	RD315
LG0	LG45	LG90	LG135	LG180	LG225	LG270	LG315

H * La medida de la cota H (distancia entre el suelo y el eje) varía según las orientaciones

MOD.	FRAME	A*	B	C	E	F	G	HO-1-2-3	H4-5	H6-7	L	M*	N	P	R*	S	n°	Φ
CAAF 475/A	90 L/2	420	380	350	337	355	59	450	355	450	101	215	269	245	140	25	4	10
CAAF 475/A	100 LA/2	450	380	350	337	355	59	450	355	450	101	260	312	280	185	25	4	12
CAAF 560/B	112 M/2	465	425	390	380	400	63	500	400	500	106	260	312	280	185	25	4	12
CAAF 560/B	132 SA/2	555	425	390	380	400	63	500	400	500	106	320	342	310	245	25	4	12
CAAF 560/A	112 M/2	465	425	390	380	400	63	500	400	500	106	260	312	280	185	25	4	12
CAAF 560/A	132 SA/2	555	425	390	380	400	63	500	400	500	106	320	342	310	245	25	4	12
CAAF 630/B	132 SA/2	565	470	430	420	450	70	560	450	560	112	320	342	310	245	25	4	12
CAAF 630/B	132 SB/2	565	470	430	420	450	70	560	450	560	112	320	342	310	245	25	4	12
CAAF 630/A	132 SB/2	565	470	430	420	450	70	560	450	560	112	320	342	310	245	25	4	12
CAAF 630/A	160 MA/2	595	470	430	420	450	70	560	450	560	112	320	342	310	245	25	4	12
CAAF 710/B	132 SB/2	580	525	475	470	475	77	630	475	630	119	320	342	310	245	25	4	12
CAAF 710/B	160 MA/2	650	525	475	470	475	77	630	475	630	119	425	440	400	345	30	4	14
CAAF 710/B	160 MB/2	650	525	475	470	475	77	630	475	630	119	425	440	400	345	30	4	14
CAAF 710/A	160 MA/2	650	525	475	470	475	77	630	475	630	119	425	440	400	345	30	4	14
CAAF 710/A	160 MB/2	650	525	475	470	475	77	630	475	630	119	425	440	400	345	30	4	14
CAAF 710/A	160 L/2	730	525	475	470	475	77	630	475	630	119	425	440	400	345	30	4	14
CAAF 800/B	160 MB/2	665	595	540	537	530	85	710	530	710	127	425	440	400	345	30	4	14
CAAF 800/B	160 L/2	745	595	540	537	530	85	710	530	710	127	425	440	400	345	30	4	14
CAAF 800/B	180 M/2	785	595	540	537	530	85	710	530	710	127	470	490	450	370	30	4	17
CAAF 800/A	160 MB/2	665	595	540	537	530	85	710	530	710	127	425	440	400	345	30	4	14
CAAF 800/A	160 L/2	745	595	540	537	530	85	710	530	710	127	425	440	400	345	30	4	14
CAAF 800/A	180 M/2	785	595	540	537	530	85	710	530	710	147	470	490	450	370	30	4	17
CAAF 800/A	200 LA/2	845	595	540	537	530	85	710	530	710	157	540	608	565	420	40	4	19
CAAF 900/B	180 M/2	805	670	615	600	600	92	800	600	800	156	470	490	450	370	30	4	17
CAAF 900/B	200 LA/2	865	670	615	600	600	92	800	600	800	166	540	558	515	420	40	4	19
CAAF 900/B	200 LB/2	865	670	615	600	600	92	800	600	800	166	540	558	515	420	40	4	19
CAAF 900/B	225 M/2	915	670	615	600	600	92	800	600	800	166	550	608	565	430	40	4	19
CAAF 900/A	200 LA/2	865	670	615	600	600	92	800	600	800	166	540	558	515	420	40	4	19
CAAF 900/A	200 LB/2	865	670	615	600	600	92	800	600	800	166	540	558	515	420	40	4	19
CAAF 900/A	225 M/2	915	670	615	600	600	92	800	600	800	166	550	608	565	430	40	4	19
CAAF 900/A	250 M/2	990	670	615	600	600	92	800	600	800	166	620	704	645	490	50	4	19

(*) Para construcciones a "ALTA TEMP." cotas "A-M-R" + 50 mm.
(kg) Peso ventilador con motor.
WD* = Momento de inercia del rodete, expresado en Kg x m²

LARGE SERIES

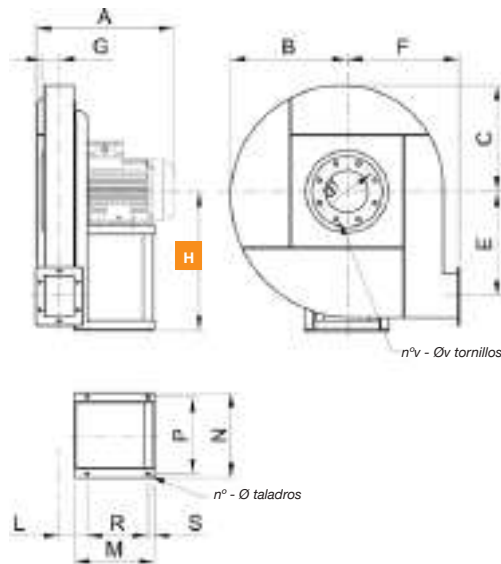
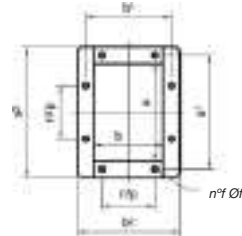
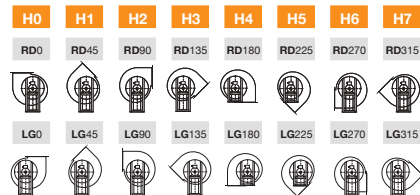
Dimensiones mm
CAAF 475...900

BOCA DE IMPULSIÓN

ORIENTACIONES

H * La medida de la cota H (distancia entre el suelo y el eje) varía según las orientaciones

MOD.	BOCA IMPULSIÓN												kg	WD ²	
	d ¹	n°v	Øv	a	b	a ¹	b ¹	a ²	b ²	n°p	n°p	n°f			Øf
CAAF 475/A	200	8	M6	129	95	165	130	189	155	-	1-100	6	10	65	1
CAAF 475/A	200	8	M6	129	95	165	130	189	155	-	1-100	6	10	75	1
CAAF 560/B	219	8	M6	145	106	182	141	215	176	-	1-112	6	10	90	1,6
CAAF 560/B	219	8	M6	145	106	182	141	215	176	-	1-112	6	10	110	1,6
CAAF 560/A	219	8	M6	145	106	182	141	215	176	-	1-112	6	10	95	2,3
CAAF 560/A	219	8	M6	145	106	182	141	215	176	-	1-112	6	10	120	2,3
CAAF 630/B	241	8	M6	165	117	200	153	235	187	-	1-112	6	10	135	2,9
CAAF 630/B	241	8	M6	165	117	200	153	235	187	-	1-112	6	10	140	2,9
CAAF 630/A	241	8	M6	165	117	200	153	235	187	-	1-112	6	10	145	3,3
CAAF 630/A	241	8	M6	165	117	200	153	235	187	-	1-112	6	10	160	3,3
CAAF 710/B	265	8	M6	185	131	219	167	255	201	-	1-112	6	10	165	4,6
CAAF 710/B	265	8	M6	185	131	219	167	255	201	-	1-112	6	10	190	4,6
CAAF 710/B	265	8	M6	185	131	219	167	255	201	-	1-112	6	10	225	4,6
CAAF 710/A	265	8	M6	185	131	219	167	255	201	-	1-112	6	10	200	5,8
CAAF 710/A	265	8	M6	185	131	219	167	255	201	-	1-112	6	10	230	5,8
CAAF 710/A	265	8	M6	185	131	219	167	255	201	-	1-112	6	10	250	5,8
CAAF 800/B	292	8	M8	205	146	241	182	275	216	1-112	1-112	8	12	270	7,5
CAAF 800/B	292	8	M8	205	146	241	182	275	216	1-112	1-112	8	12	290	7,5
CAAF 800/B	292	8	M8	205	146	241	182	275	216	1-112	1-112	8	12	320	7,5
CAAF 800/A	292	8	M8	205	146	241	182	275	216	1-112	1-112	8	12	280	10
CAAF 800/A	292	8	M8	205	146	241	182	275	216	1-112	1-112	8	12	290	10
CAAF 800/A	292	8	M8	205	146	241	182	275	216	1-112	1-112	8	12	320	10
CAAF 800/A	292	8	M8	205	146	241	182	275	216	1-112	1-112	8	12	370	10
CAAF 900/B	332	8	M8	229	164	265	200	299	234	1-112	1-112	8	12	370	12,5
CAAF 900/B	332	8	M8	229	164	265	200	299	234	1-112	1-112	8	12	400	12,5
CAAF 900/B	332	8	M8	229	164	265	200	299	234	1-112	1-112	8	12	460	12,5
CAAF 900/B	332	8	M8	229	164	265	200	299	234	1-112	1-112	8	12	500	12,5
CAAF 900/A	332	8	M8	229	164	265	200	299	234	1-112	1-112	8	12	420	15,5
CAAF 900/A	332	8	M8	229	164	265	200	299	234	1-112	1-112	8	12	480	15,5
CAAF 900/A	332	8	M8	229	164	265	200	299	234	1-112	1-112	8	12	520	15,5
CAAF 900/A	332	8	M8	229	164	265	200	299	234	1-112	1-112	8	12	600	15,5

(*) Para construcciones a "ALTA TEMP." cotas "A-M-R" + 50 mm.
 (kg) Peso ventilador con motor.
 WD² = Momento de inercia del rodetes, expresado en Kg x m²

Para obtener las dimensiones de los sistemas 1, 9 y 12 consultar a nuestro equipo técnico.

Accesorios

Contrabrida aspiración

n° - Ø taladros

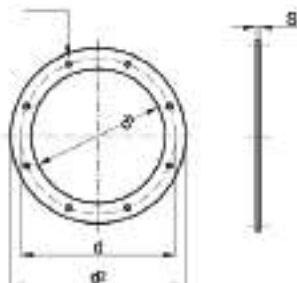

MOD.	d	d'	d²	n°	Φ	s	kg
CAAF 475	200	165	235	8	9	4	0,65
CAAF 560	219	185	255	8	9	4	0,7
CAAF 630	241	205	275	8	9	4	0,75
CAAF 710	265	229	299	8	9	4	0,8
CAAF 800	292	255	325	8	11	4	1
CAAF 900	332	286	366	8	11	5	1,6

Contrabrida impulsión

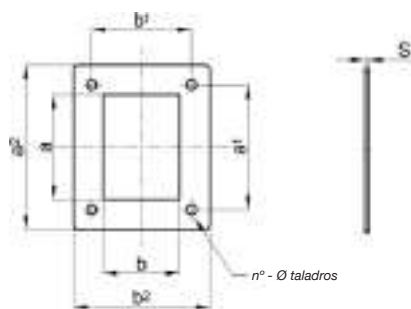

MOD.	a	b	a'	b'	a²	b²	n¹p	n²p	n°	Φ	s	kg
CAAF 475	129	95	165	130	189	155	-	1-100	6	10	4	0,5
CAAF 560	145	106	182	141	215	176	-	1-112	6	10	4	0,7
CAAF 630	165	117	200	153	235	187	-	1-112	6	10	4	0,75
CAAF 710	185	131	219	167	255	201	-	1-112	6	10	4	0,8
CAAF 800	206	147	241	182	276	217	1-112	1-112	8	12	4	0,9
CAAF 900	229	167	265	200	299	234	1-112	1-112	8	12	4	1

Red protección en aspiración

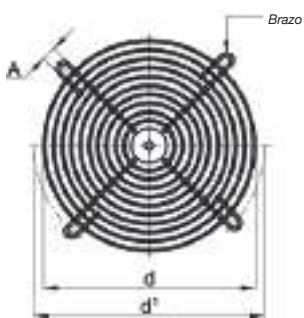

MOD.	d	d'	A	n°	kg
CAAF 475	165	200	9	4	0,15
CAAF 560	185	219	9	4	0,18
CAAF 630	205	241	9	4	0,2
CAAF 710	229	265	9	4	0,25
CAAF 800	255	292	11	4	0,3
CAAF 900	286	332	11	4	0,35

Junta anti vibratoria en aspiración

n° - Ø taladros

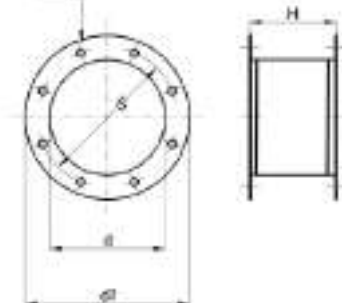

MOD.	d	d'	d²	n°	Φ	H	kg
CAAF 475	200	165	235	8	9	200	1,6
CAAF 560	219	185	255	8	9	200	1,7
CAAF 630	241	205	275	8	9	200	1,8
CAAF 710	265	229	299	8	9	200	2
CAAF 800	292	255	325	8	11	200	2,2
CAAF 900	332	286	366	8	11	200	3,4

LARGE SERIES

Accesorios

Junta anti vibratoria en impulsión

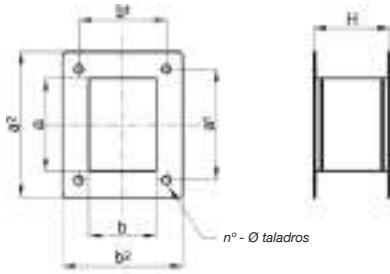

MOD.	a	b	a'	b'	a''	b''	n°p	n°p	n°	Φ	H	kg
CAAF 475	129	95	165	130	189	155	-	1-100	6	10	200	1,2
CAAF 560	145	106	182	141	215	176	-	1-112	6	10	200	1,6
CAAF 630	165	117	200	153	235	187	-	1-112	6	10	200	1,7
CAAF 710	185	131	219	167	255	201	-	1-112	6	10	200	1,8
CAAF 800	206	147	241	182	276	217	1-112	1-112	8	12	200	2
CAAF 900	229	164	265	200	299	234	1-112	1-112	8	12	200	2,2

Amortiguadores

TIPO 1

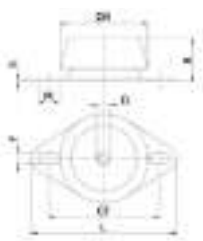

TIPO 2

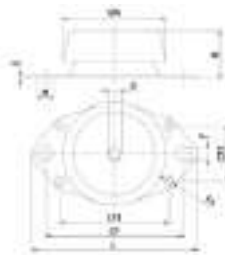

MOD.	MODELO AMORTIGUADORES	TIPO	øA	B	D	CF	CF1	CF2	F	øF1	L	M	S
CAAF 475	CF 623110	1	67	33...34	10	76,5	-	-	9	-	90,5	16	2
CAAF 560	CF 623110	1	67	33...34	10	76,5	-	-	9	-	90,5	16	2
CAAF 630	CF 623110	1	67	33...34	10	76,5	-	-	9	-	90,5	16	2
CAAF 710	CF 623110	1	67	33...34	10	76,5	-	-	9	-	90,5	16	2
CAAF 800	CF 924512	2	92	44...45	12	120	98	50	10,5	8,5	130	15,5	2,5
CAAF 900	CF 924512	2	92	44...45	12	120	98	50	10,5	8,5	130	15,5	2,5

Silenciadores circulares

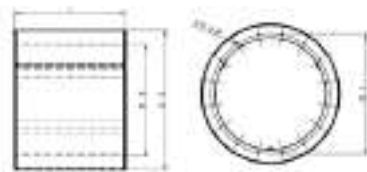

Los silenciadores se utilizan para bajar el nivel sonoro en instalaciones de acondicionamiento o ventilación, fabricados en acero cincado

- Bajo demanda: otras construcciones en diferentes materiales.

øD	øE	L	øI	F	øM	øD	øE	L	øI	F	øM
315	515	ØD,1,5ØD, 2ØD	355	8	M8	900	1100	ØD,1,5ØD, 2ØD	970	16	M10
355	555	ØD,1,5ØD, 2ØD	395	8	M8	1000	1200	ØD,1,5ØD, 2ØD	1070	16	M10
400	600	ØD,1,5ØD, 2ØD	450	8	M8	1120	1320	ØD,1,5ØD, 2ØD	1190	20	M10
450	650	ØD,1,5ØD, 2ØD	500	8	M8	1250	1450	ØD,1,5ØD, 2ØD	1320	20	M10
500	700	ØD,1,5ØD, 2ØD	560	12	M8	1400	1600	ØD,1,5ØD, 2ØD	1470	20	M10
560	760	ØD,1,5ØD, 2ØD	620	12	M8	1500	1700	ØD,1,5ØD, 2ØD	1570	20	M10
630	830	ØD,1,5ØD, 2ØD	690	12	M8	1600	1800	ØD,1,5ØD, 2ØD	1680	24	M14
710	910	ØD,1,5ØD, 2ØD	770	16	M8	1700	1900	ØD,1,5ØD, 2ØD	1780	24	M14
800	1000	ØD,1,5ØD, 2ØD	860	16	M8	1800	2000	ØD,1,5ØD, 2ØD	1880	24	M14

MOTOR DIRECTO

CAST

Ventiladores centrífugos de pala abierta y simple aspiración de gran robustez con envolvente y turbina en chapa de acero

Diseñados para aire con mucho polvo y materiales en suspensión



SISTEMA

4



Ventilador:

- Envolvente en chapa de acero.
- Turbina a reacción, en chapa de acero de gran robustez, especialmente diseñados para aire con mucho polvo y materiales en suspensión.
- Motor directamente acoplado.
- Con trampilla de inspección y limpieza a partir del tamaño 560.
- Todas las carcasas soldadas en continuo.

Motor:

- Motores con eficiencia IE3 para potencias iguales o superiores a 0,75 kW, excepto monofásicos, 2 velocidades y 8 polos.
- Motores clase F con rodamientos a bolas. Protección IP55.
- Trifásicos 230/400 V 50 Hz (hasta 4 kW) y 400/690 V 50 Hz (potencias superiores a 4 kW).
- Temperatura máxima del aire a transportar: -25 °C +90 °C.

Acabado:

- Anticorrosivo en resina de poliéster polimerizada a 190 °C, previo desengrase con tratamiento nanotecnológico libre de fosfatos.

Bajo demanda:

- Bobinados especiales para diferentes tensiones.
- Ventilador preparado para transportar aire hasta +150 °C.
- Ejecuciones especiales para temperaturas +300 °C.
- Ventilador en acero inoxidable.
- Certificación ATEX Categoría 2.
- Acoplamiento elástico sistema 8.

* Las imágenes son solo a nivel ilustrativo, el producto puede variar en función del tamaño, especificaciones y posición.

Código de pedido

CAST — 500 — 2T — 15

CAST: Ventiladores centrífugos de pala abierta y simple aspiración de gran robustez con envolvente y turbina en chapa de acero

Tamaño turbina

Número de polos motor
2=2900 r/min 50 Hz

T=Trifásico

Potencia motor (CV)

Formas constructivas motor directo

SISTEMA

4

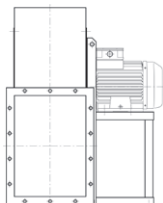

Accionamiento directo, turbina montada en el eje motor, motor de brida montado sobre la silleta.

SISTEMA

5

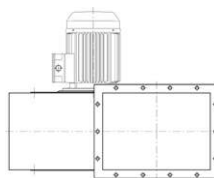

Accionamiento directo, turbina montada en el eje motor, motor de brida montado sobre la carcasa del ventilador.

SISTEMA

8

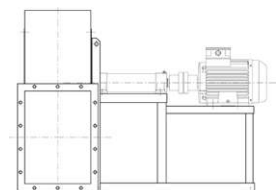

Accionamiento por acoplamiento elástico, turbina montada en el eje soporte, montado al motor mediante acoplamiento elástico. Todo montado conjuntamente sobre la silleta ventilador.

Orientaciones

RD 0 RD45 RD90 RD135 RD180 RD225 RD270 RD315 LG 0 LG45 LG90 LG135 LG180 LG225 LG270 LG315

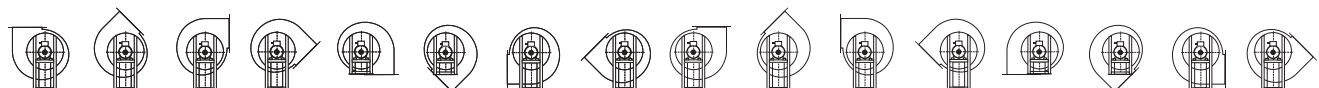

Suministro estándar LG270, otras posiciones bajo demanda. Todos los modelos son orientables. Medidas especiales en posiciones 180 y 225.

Características técnicas

Modelo	Frame	Velocidad (r/min)	Intensidad máx admisible (A)			Potencia instalada (kW)	Caudal máximo (m3/h)	Nivel Presión Sonora dB(A)	Peso aprox (Kg)	According ErP
			230 V	400 V	690 V					
CAST-400-2T-3 IE3	90L	2910	7,32	4,21		2,2	1260	80	45	2015
CAST-450-2T-4 IE3	100L	2910	10	5,77		3	1620	82	60	2015
CAST-450-2T-5.5 IE3	112M	2900	13	7,5		4	1800	83	65	2015
CAST-500-2T-7.5 IE3	132S	2930		10,1	5,86	5,5	2520	85	97	2015
CAST-500-2T-10 IE3	132S	2930		14,1	8,17	7,5	3470	85	103	2015
CAST-560-2T-15 IE3	160M	2945		20	11,6	11	3600	90	158	2015
CAST-630-2T-20 IE3	160M	2945		27,7	16,1	15	4320	93	193	2015
CAST-630-2T-25 IE3	160L	2945		33,9	19,7	18,5	5040	93	203	2015
CAST-710-2T-30 IE3	180M	2950		39,7	23	22	4320	96	253	2015
CAST-710-2T-40 IE3	200L	2960		54,5	31,6	30	6480	96	365	2015
CAST-710-2T-50 IE3	200L	2960		67,8	39,3	37	7740	96	373	2015
CAST-800-4T-10 IE3	132M	1465		13,9	8,06	7,5	5040	81	250	2015
CAST-900-4T-15 IE3	160M	1470		20,9	12,1	11	7790	85	440	2015
CAST-900-4T-20 IE3	160L	1465		27,9	16,2	15	7740	86	478	2015
CAST-1000-4T-25 IE3	180M	1470		35,1	20,3	18,5	10080	86	586	2015



Erp. (Energy Related Products)

Información de la Directiva 2009/125/EC descargable desde la web de SODECA o programa de selección QuickFan

Curvas Características

Q= Caudal en m³/h, m³/s y cfm

Pe= Presión estática en mmH₂O, Pa e inwg

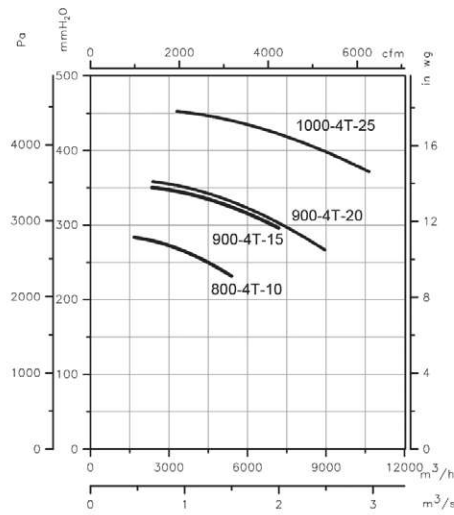
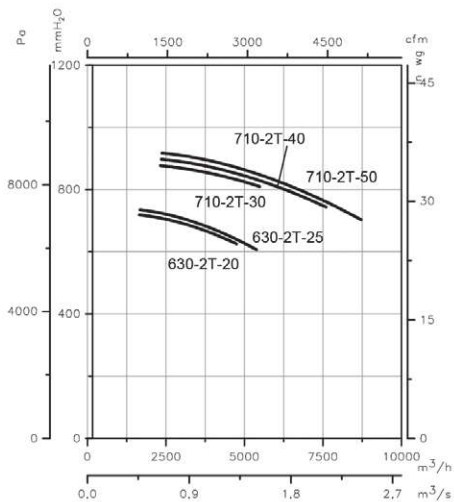
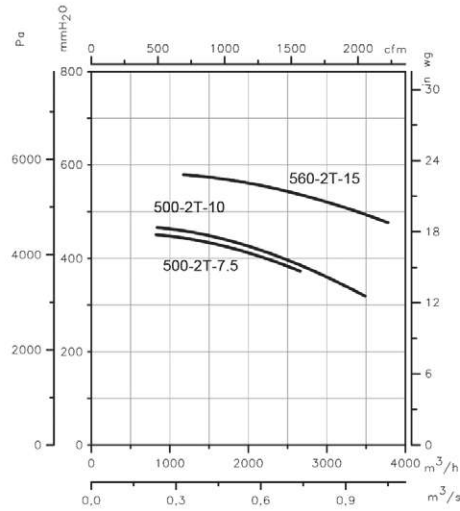
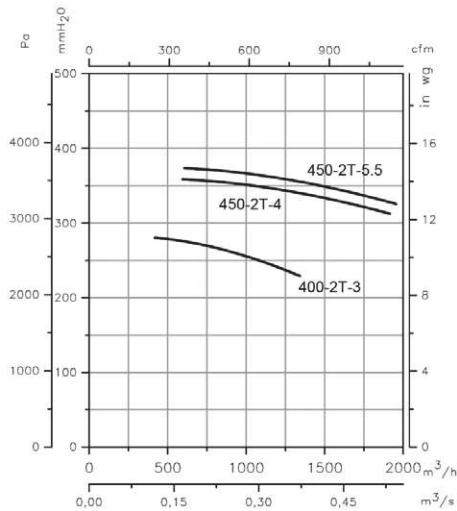

Accesorios



LARGE SERIES

MOTOR A TRANSMISIÓN

CAST-X

Ventiladores centrífugos de pala abierta accionados a transmisión, equipados con motor eléctrico, conjunto de poleas, correas y protectores normalizados según norma ISO-13857

Diseñados para aire con mucho polvo y materiales en suspensión



Motor:

- Motores con eficiencia IE3.
- Motores clase F con rodamientos a bolas. Protección IP55.
- Trifásicos 230/400 V 50 Hz (hasta 4 kW) y 400/690 V 50 Hz (potencias superiores a 4 kW).
- Temperatura máxima del aire a transportar: -25 °C +90 °C.

Acabado:

- Anticorrosivo en resina de poliéster polimerizada a 190 °C, previo desengrase con tratamiento nanotecnológico libre de fosfatos.

Bajo demanda:

- Bobinados especiales para diferentes tensiones.
- Ventilador preparado para transportar aire hasta +300 °C.
- Ventilador en acero inoxidable.
- Certificación ATEX Categoría 2.
- Acoplamiento elástico sistema 8.

Ventilador:

- Envoltente en chapa de acero.
- Turbina a reacción, en chapa de acero de gran robustez, especialmente diseñados para aire con mucho polvo y materiales en suspensión.
- Motor montado sobre bancada general.
- Con trampilla de inspección y limpieza a partir del tamaño 560.
- Todas las carcasas soldadas en continuo.

* Las imágenes son solo a nivel ilustrativo, el producto puede variar en función del tamaño, especificaciones y posición.

Formas constructivas motor a transmisión

SISTEMA 12

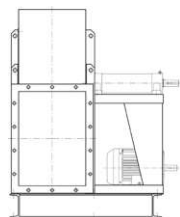

Accionamiento a transmisión, igual al SISTEMA 1, con el motor y ventilador montados en la bancada común. Posiciones de motor "W" o "Z" y excepcionalmente "X" o "Y".

SISTEMA 9

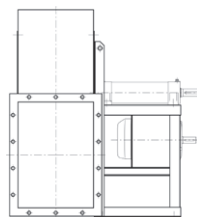

Accionamiento a transmisión, igual al SISTEMA 1, con el motor montado en el lateral de la silleta, en posición "W" o "Z".

SISTEMA 1

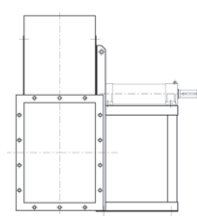

Accionamiento a transmisión, turbina montada en el eje soporte. Soporte montado sobre la silleta.

Orientaciones

RD 0 RD45 RD90 RD135 RD180 RD225 RD270 RD315

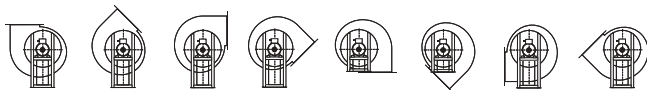

LG 0 LG45 LG90 LG135 LG180 LG225 LG270 LG315

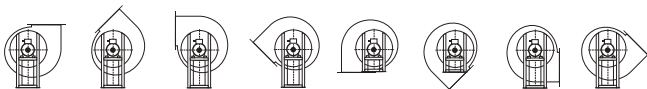

Curvas Características

CAST-X 400

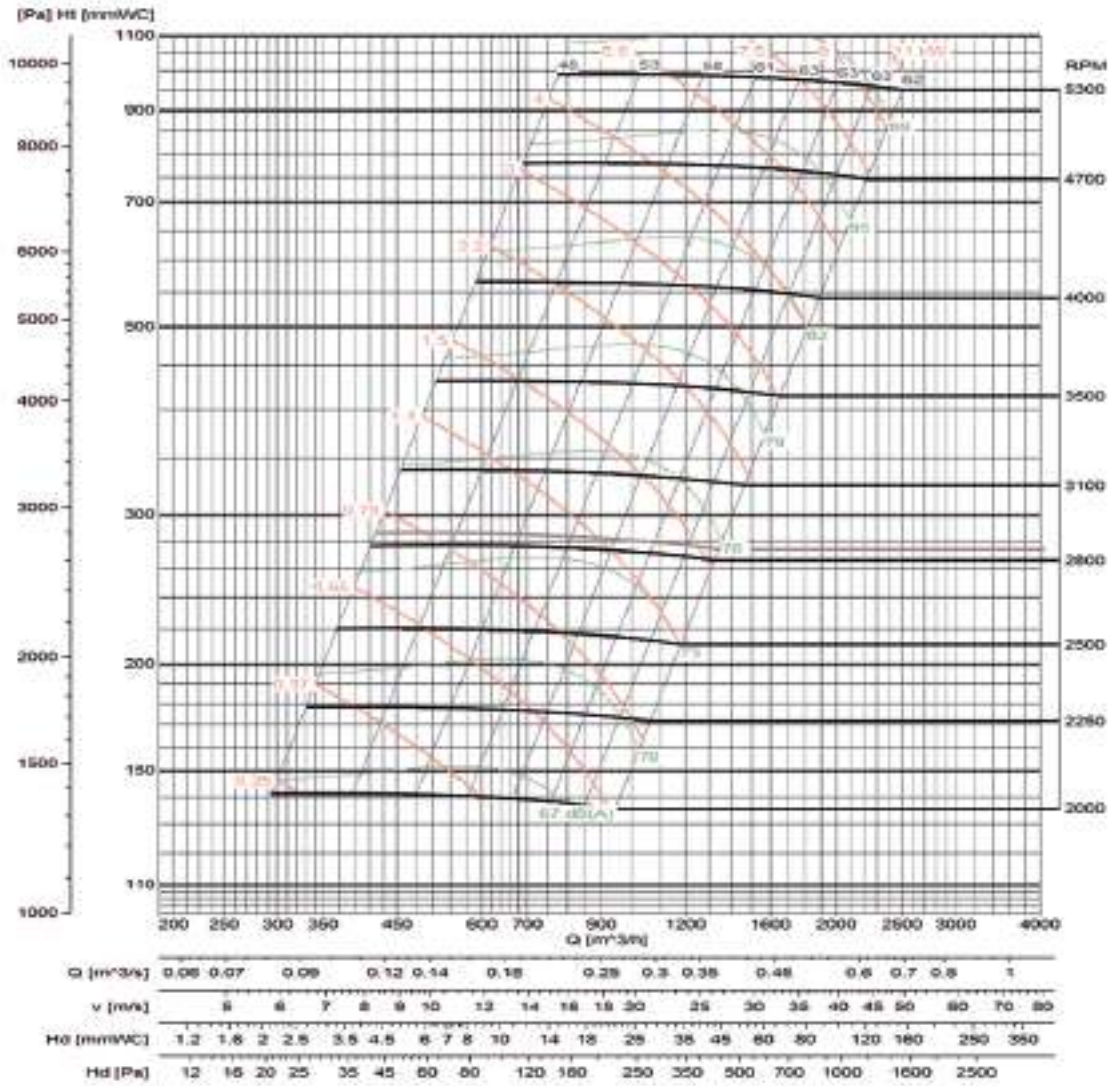

Margen sobre el caudal ± 5 %
 Margen del nivel sonoro +3...5db
 Margen kW absorbidos ± 3%

Características en impulsión.

Curvas Características

CAST-X 450

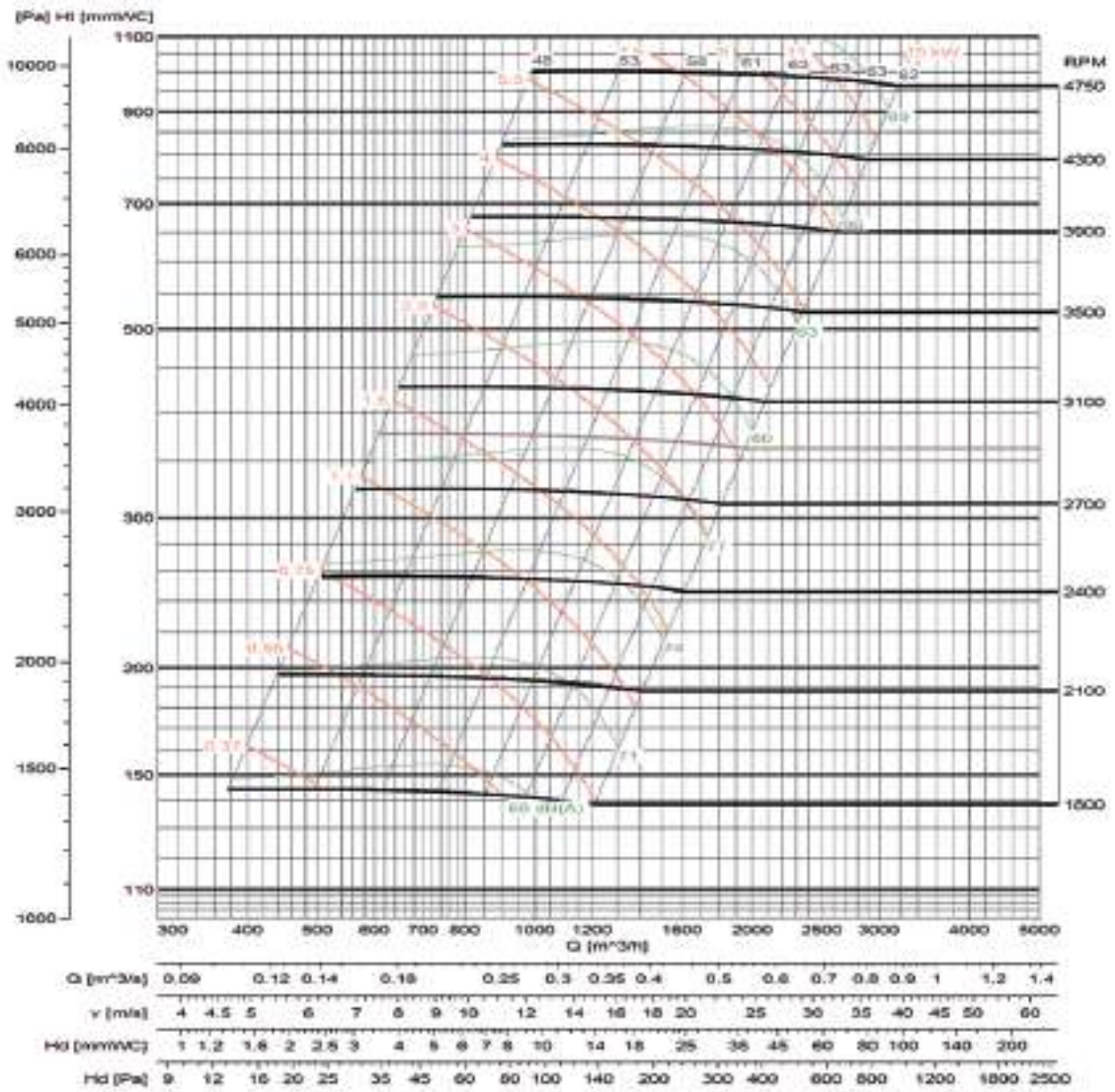

LARGE SERIES

Margen sobre el caudal ± 5 %
 Margen del nivel sonoro +3...5db
 Margen kW absorbidos ± 3%

Características en impulsión.

Curvas Características

CAST-X 500

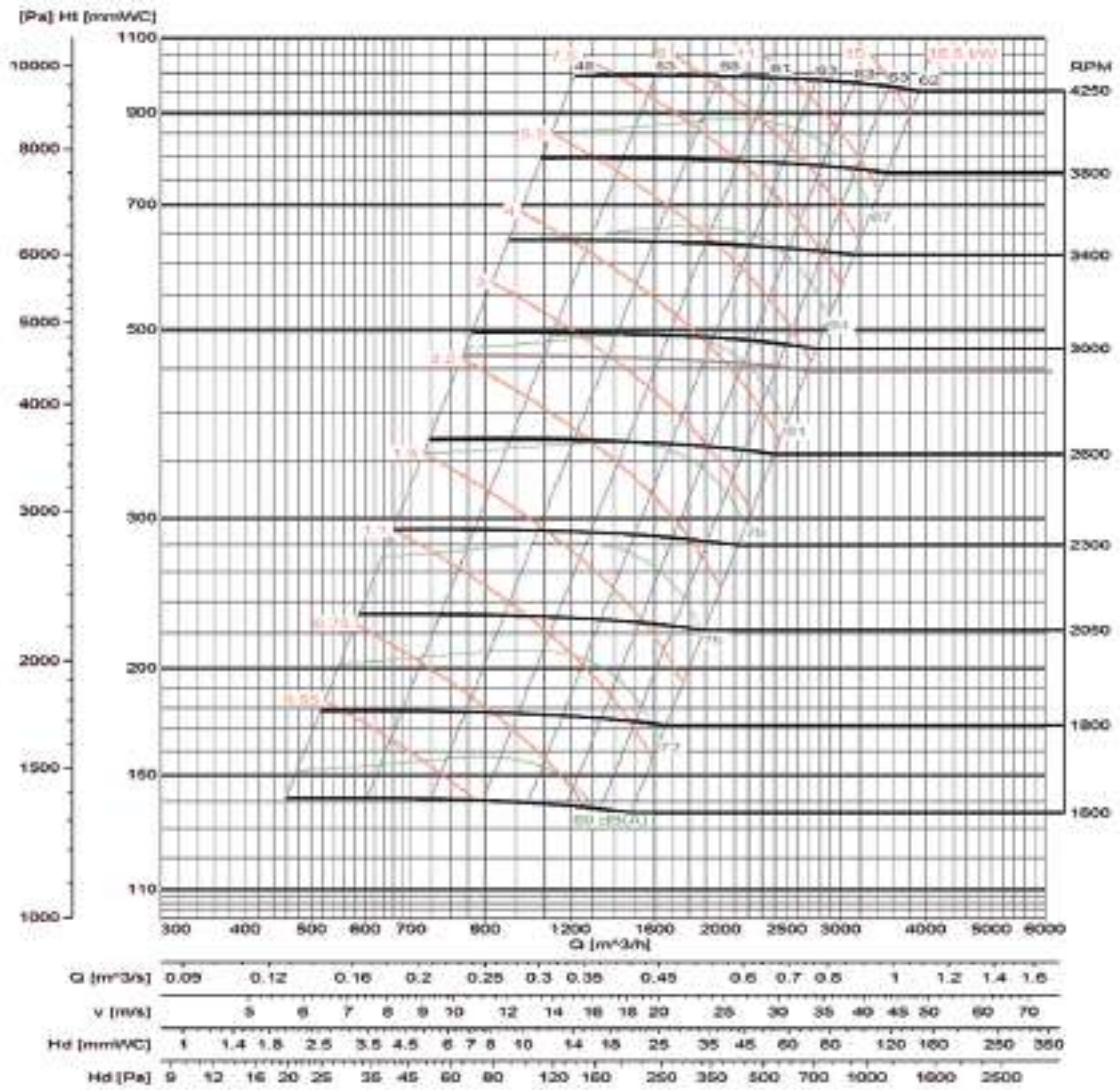

Margen sobre el caudal $\pm 5\%$
 Margen del nivel sonoro $+3...5\text{db}$
 Margen kW absorbidos $\pm 3\%$

Características en impulsión.

Curvas Características

CAST-X 560

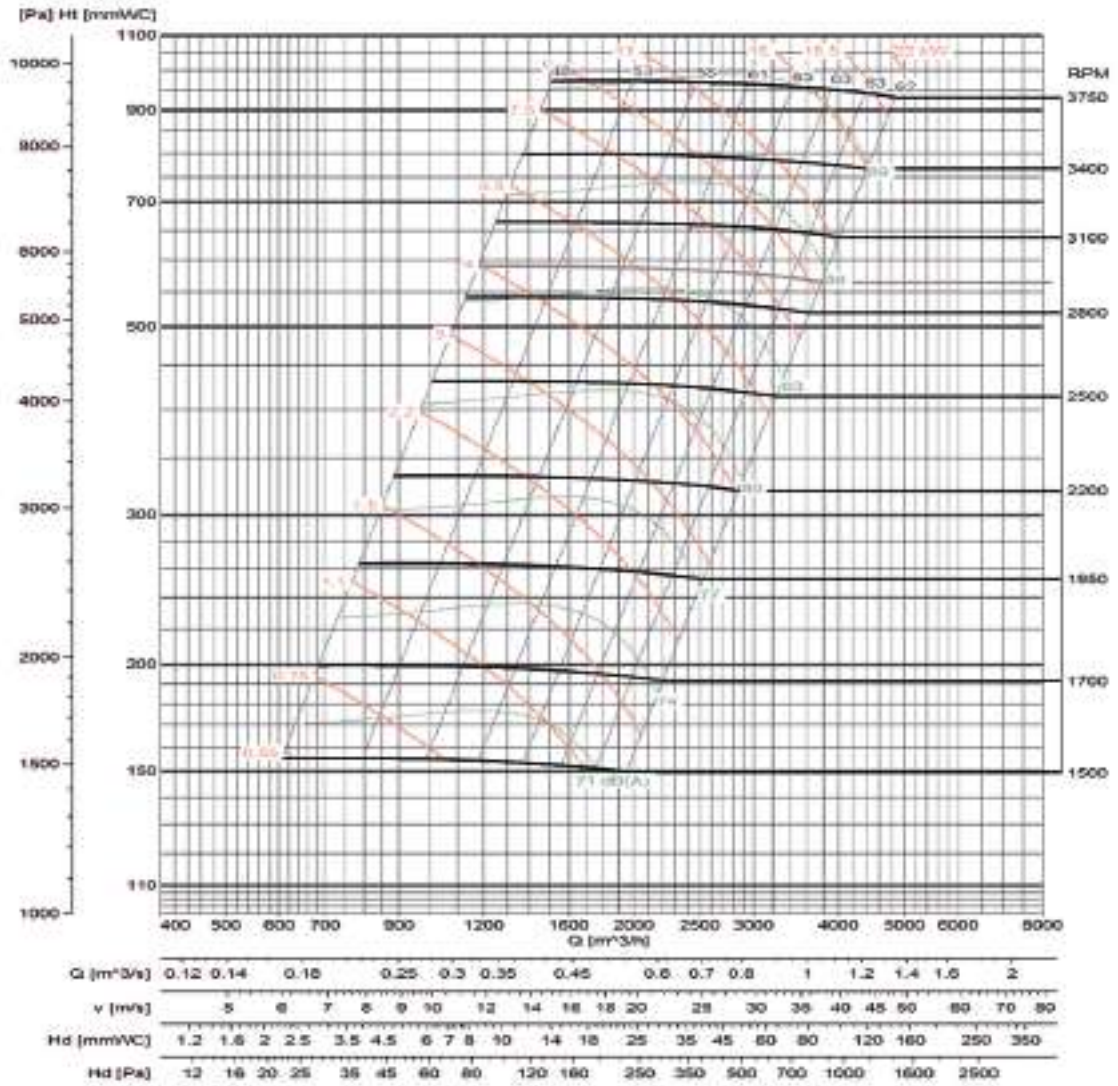

Margen sobre el caudal ± 5 %
 Margen del nivel sonoro +3...5db
 Margen kW absorbidos ± 3%

Características en impulsión.

Curvas Características

CAST-X 630

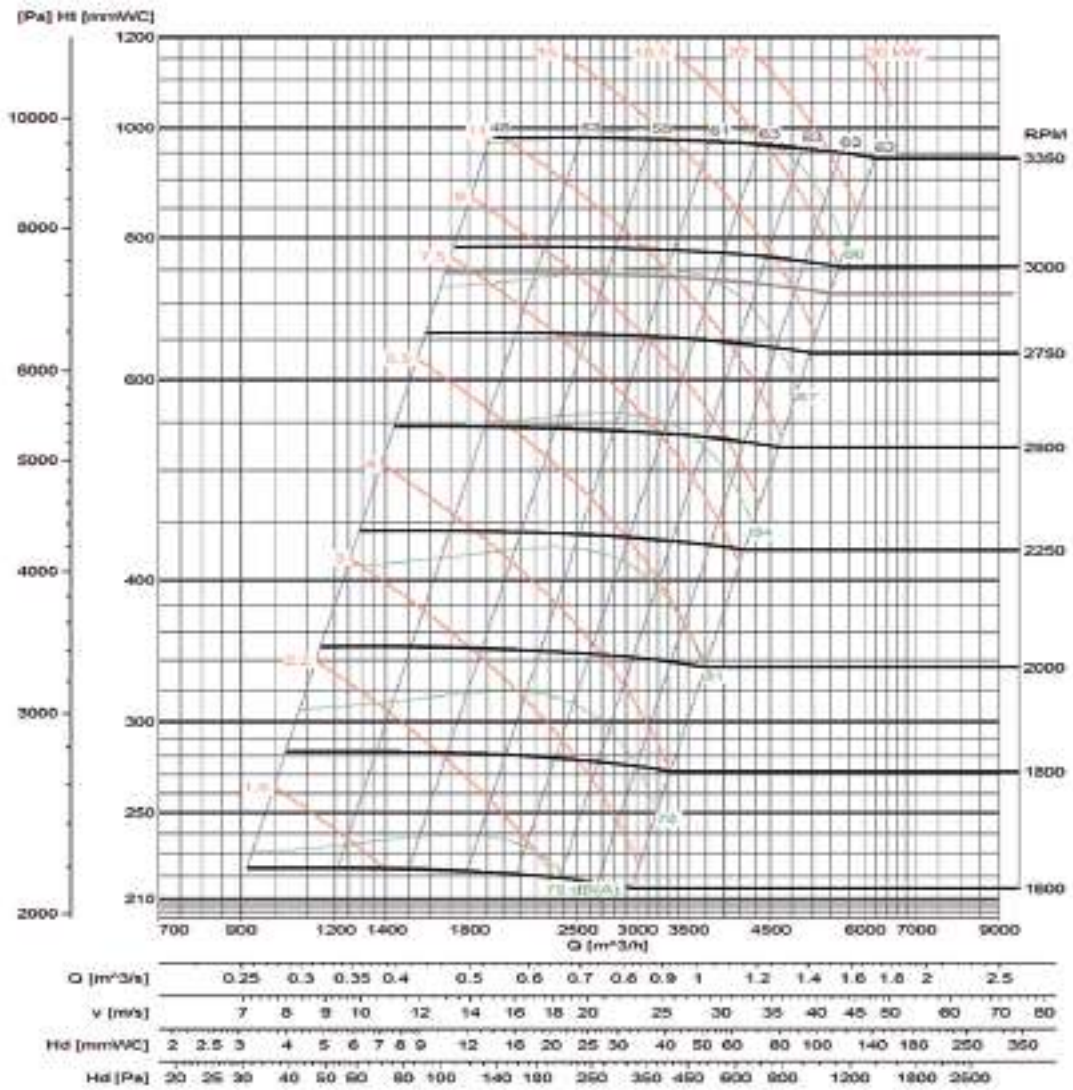

Margen sobre el caudal ± 5 %
 Margen del nivel sonoro +3...5db
 Margen kW absorbidos ± 3%

Características en impulsión.

Curvas Características

CAST-X 710

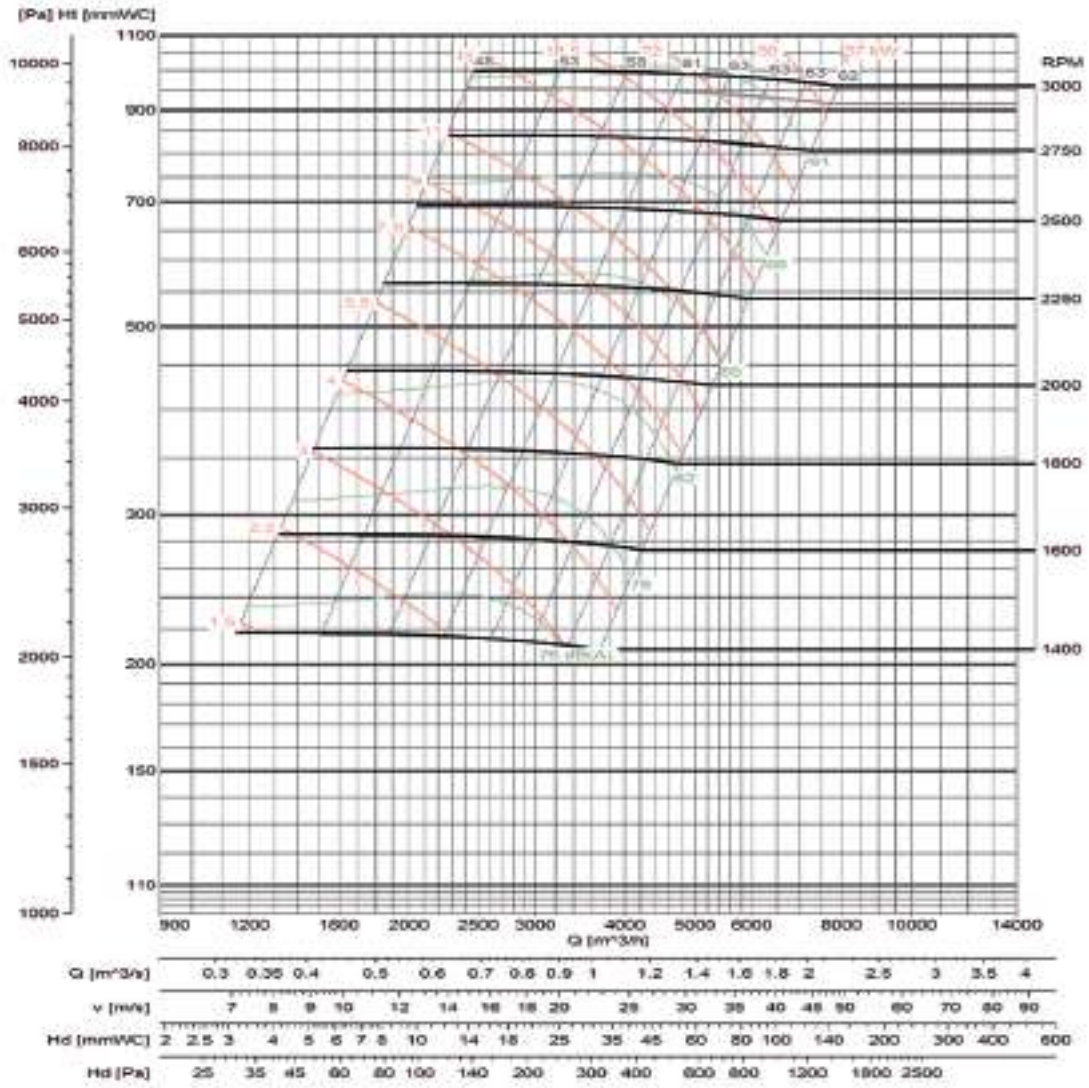

LARGE SERIES

Margen sobre el caudal ± 5 %
 Margen del nivel sonoro +3...5db
 Margen kW absorbidos ± 3%

Características en impulsión.

Curvas Características

CAST-X 800

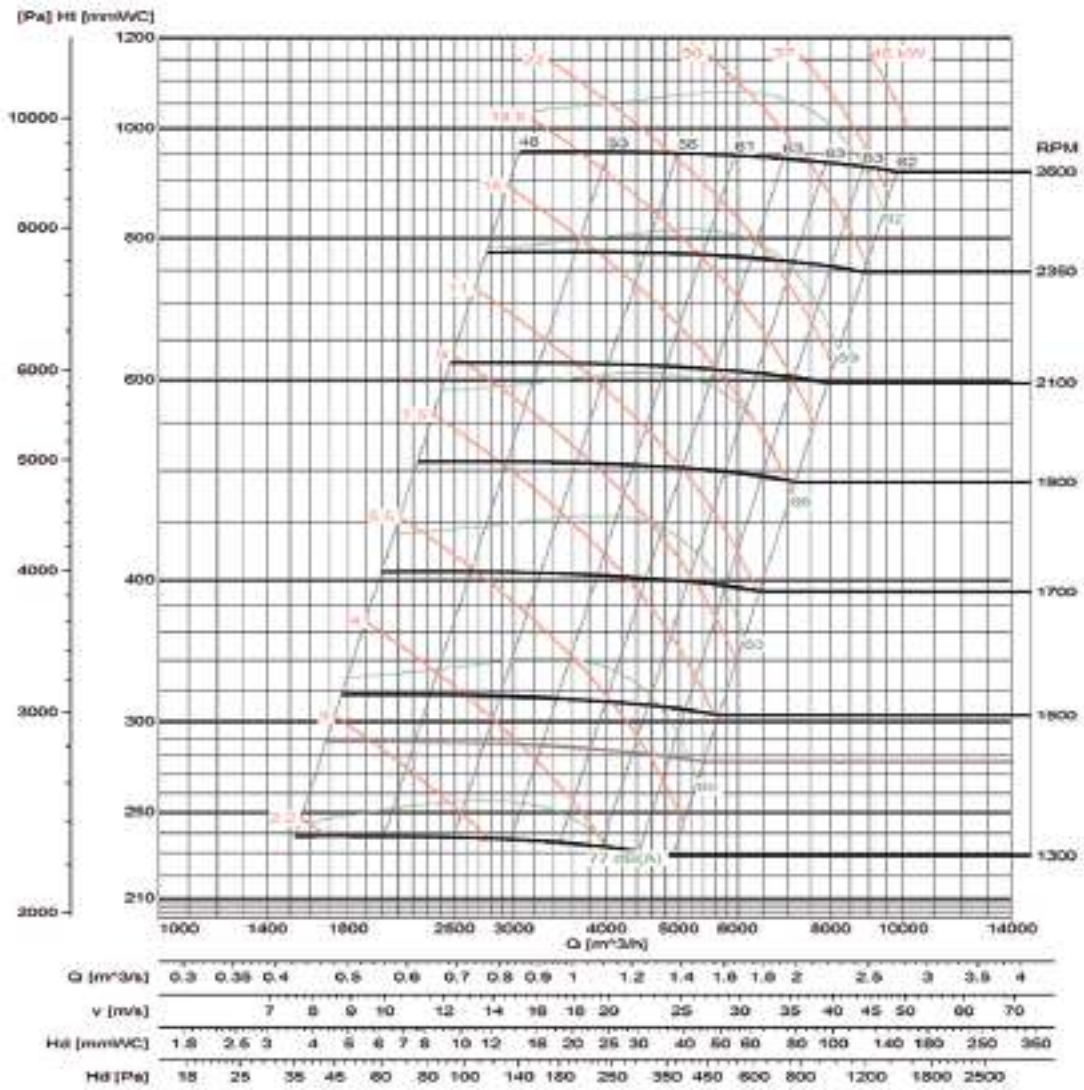

Margen sobre el caudal ± 5 %
 Margen del nivel sonoro +3...5db
 Margen kW absorbidos ± 3%

Características en impulsión.

Curvas Características

CAST-X 900

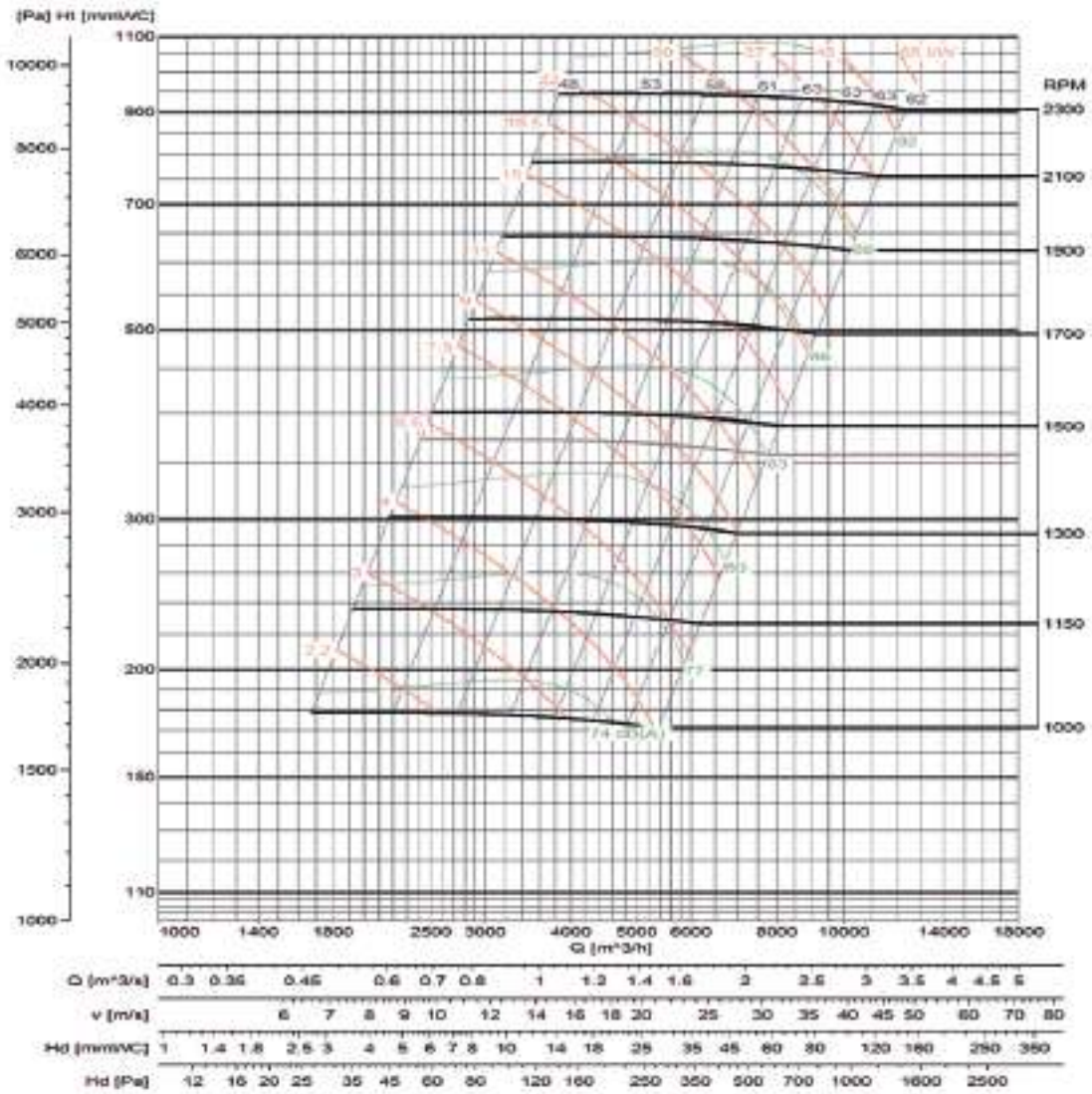

LARGE SERIES

Margen sobre el caudal ± 5 %
 Margen del nivel sonoro +3...5db
 Margen kW absorbidos ± 3%

Características en impulsión.

Curvas Características

CAST-X 1000

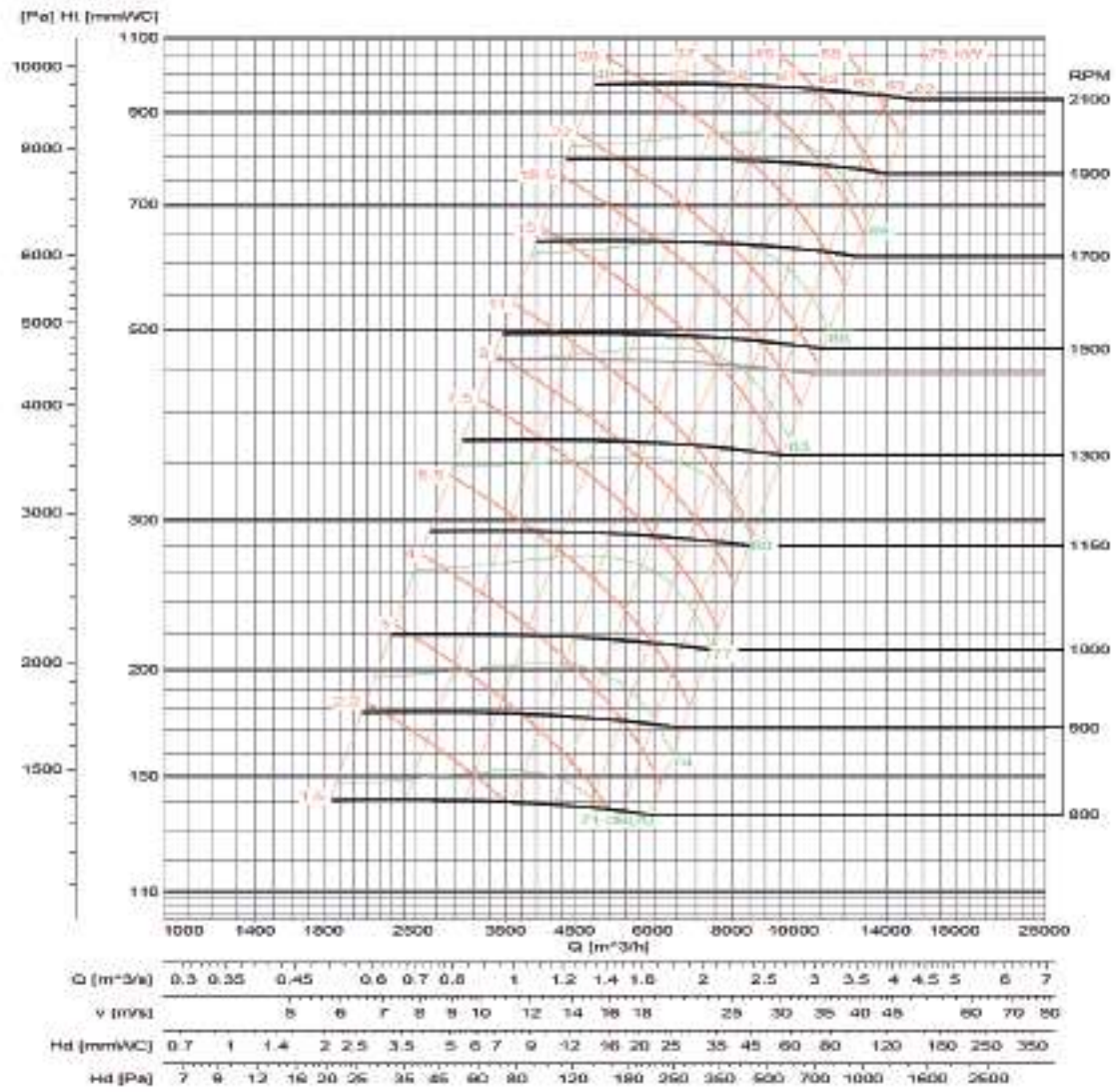

Margen sobre el caudal $\pm 5\%$
 Margen del nivel sonoro $+3...5db$
 Margen kW absorbidos $\pm 3\%$

Características en impulsión.

Dimensiones mm

SISTEMA
4

CAST 400...900

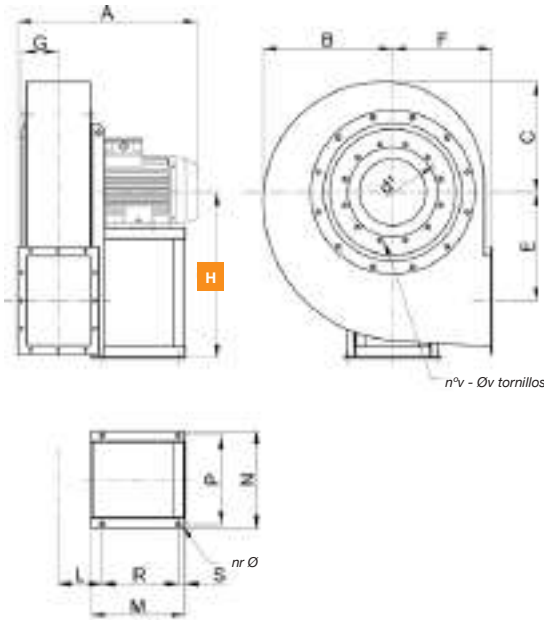

BOCA DE IMPULSIÓN

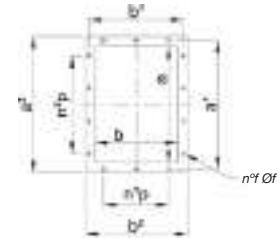

ORIENTACIONES

H0	H1	H2	H3	H4	H5	H6	H7
RD0	RD45	RD90	RD135	RD180	RD225	RD270	RD315
LG0	LG45	LG90	LG135	LG180	LG225	LG270	LG315

H * La medida de la cota H (distancia entre el suelo y el eje) varía según las orientaciones

Modelo	Frame	A	B	C	E	F	G	H	L	M	N	P	R	S	nr	Ø
CAST-400-2T-3 IE3	90L	410	300	274	240	270	71	375	113	215	269	245	140	25	4	10
CAST-450-2T-4 IE3	100L	490	332	302	265	300	77	400	120	260	312	280	185	25	4	12
CAST-450-2T-5.5 IE3	112M	500	332	302	265	300	77	400	120	260	312	280	185	25	4	12
CAST-500-2T-7.5 IE3	132S	590	374	342	300	335	88	450	127	320	342	310	245	25	4	12
CAST-500-2T-10 IE3	132S	590	374	342	300	335	88	450	127	320	342	310	245	25	4	12
CAST-560-2T-15 IE3	160M	732	425	390	340	375	97	500	136	425	440	400	345	30	4	14
CAST-630-2T-20 IE3	160M	800	478	440	381	425	106	560	146	425	440	400	345	30	4	14
CAST-630-2T-25 IE3	160L	835	478	440	381	425	106	560	146	425	440	400	345	30	4	14
CAST-710-2T-30 IE3	180M	860	531	485	425	475	117	630	177	470	550	510	370	30	4	17
CAST-710-2T-40 IE3	200L	890	531	485	425	475	117	630	187	540	608	565	420	40	4	19
CAST-710-2T-50 IE3	200L	890	531	485	425	475	117	630	187	540	608	565	420	40	4	19
CAST-800-4T-10 IE3	132M	650	595	545	481	530	129	710	170	320	342	310	245	25	4	12
CAST-900-4T-15 IE3	160M	850	674	616	542	600	143	800	183	425	440	400	345	30	4	14
CAST-900-4T-20 IE3	160L	870	674	616	542	600	143	800	183	425	440	400	345	30	4	14

MOD.	BOCA IMPULSIÓN													
	a	b	a ¹	b ¹	a ²	b ²	n ¹ p	n ² p	n ^f	Øf	d1	n ^v	Øv	
CAST-400-2T-3 IE3	165	117	200	153	235	187	-	1-112	6	10	219	8	M8	
CAST-450-2T-4 IE3	185	131	219	167	255	201	-	1-112	6	10	241	8	M8	
CAST-450-2T-5.5 IE3	185	131	219	167	255	201	-	1-112	6	10	241	8	M8	
CAST-500-2T-7.5 IE3	205	146	241	182	275	216	1-112	1-112	8	12	265	8	M8	
CAST-500-2T-10 IE3	205	146	241	182	275	216	1-112	1-112	8	12	265	8	M8	
CAST-560-2T-15 IE3	229	164	265	200	299	234	1-112	1-112	8	12	292	8	M8	
CAST-630-2T-20 IE3	256	183	292	219	326	253	1-112	2-112	10	12	332	8	M8	
CAST-630-2T-25 IE3	256	183	292	219	326	253	1-112	2-112	10	12	332	8	M8	
CAST-710-2T-30 IE3	288	205	332	249	368	285	1-125	2-125	10	12	366	8	M8	
CAST-710-2T-40 IE3	288	205	332	249	368	285	1-125	2-125	10	12	366	8	M8	
CAST-710-2T-50 IE3	288	205	332	249	368	285	1-125	2-125	10	12	366	8	M8	
CAST-800-4T-10 IE3	322	229	366	273	402	309	1-125	2-125	10	12	405	8	M8	
CAST-900-4T-15 IE3	361	256	405	300	441	336	1-125	2-125	10	12	448	12	M10	
CAST-900-4T-20 IE3	361	256	405	300	441	336	1-125	2-125	10	12	448	12	M10	

Para obtener las dimensiones del modelo 1000 consultar a nuestro equipo técnico.

LARGE SERIES

Dimensiones mm

CAST-X 400...900

SISTEMA
1

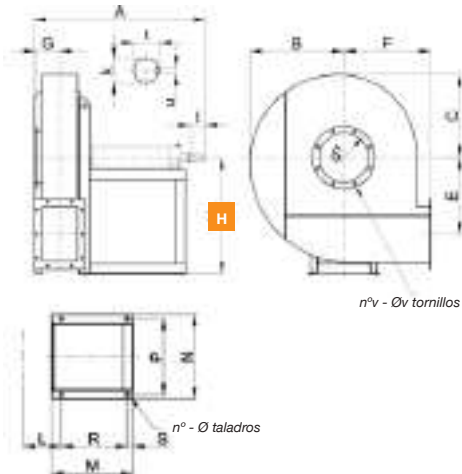

SISTEMA
12

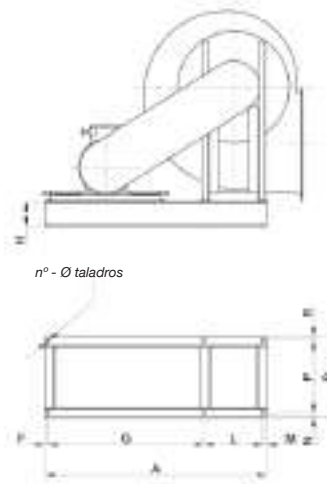

MOD.	A*	B	C	E	F	G	H	L	M*	N
CAST 400	694	300	274	240	270	71	375	113	480	350
CAST 450	807	332	302	265	300	77	400	120	560	370
CAST 500	825	374	342	300	335	88	450	127	560	370
CAST 560	823	425	390	340	375	97	500	136	520	438
CAST 630	842	478	440	381	425	106	560	146	520	438
CAST 710	979	531	485	425	475	117	630	187	605	456
CAST 800	1053	595	545	481	530	129	710	199	655	496
CAST 900	1121	674	616	542	600	143	800	183	705	564

MOD.	A	B*	H	F	G	L	M	N	P
CAST 400	900	450	120	20	550	310	20	25	400
CAST 450	1055	530	120	25	680	330	20	25	480
CAST 500	1055	530	120	25	680	330	20	25	480
CAST 560	1265	485	160	25	830	385	25	30	430
CAST 630	1445	550	160	25	1010	385	25	30	495
CAST 710	1505	575	180	30	1050	395	30	30	515
CAST 800	1775	700	180	30	1280	435	30	30	640
CAST 900	1880	750	180	30	1320	500	30	35	680

MOD.	P	R*	S	n°	Φ	k	l	t	u	d1	n° v	Ø v
CAST 400	310	400	30	4	14	28 k6	60	31	8	219	8	M8
CAST 450	330	480	30	4	14	38 k6	80	41	10	241	8	M8
CAST 500	330	480	30	4	14	38 k6	80	41	10	265	8	M8
CAST 560	385	430	40	4	17	42 k6	110	45	12	292	8	M8
CAST 630	385	430	40	4	17	48 k6	110	51,5	14	332	8	M8
CAST 710	395	515	40	4	19	48 k6	110	51,5	14	366	8	M8
CAST 800	435	565	40	4	19	55 m6	110	59	16	405	12	M10
CAST 900	500	605	50	4	19	65 m6	140	69	18	448	12	M10

MOD.	R	n°	Φ	Kg
CAST 400	25	6	14	40
CAST 450	25	6	14	45
CAST 500	25	6	14	45
CAST 560	25	6	17	70
CAST 630	25	6	17	90
CAST 710	30	6	19	100
CAST 800	30	6	19	130
CAST 900	35	6	19	185

(*) Para construcciones a "ALTA TEMP." cotas "A-M-R" +50 mm.

(*) Para construcciones a "ALTA TEMP." cotas "B-P" +50 mm.
Kg = Peso de la base soporte

BOCA DE IMPULSIÓN

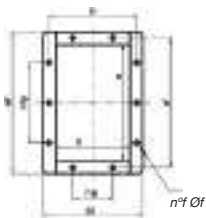

BOCA IMPULSIÓN

MOD.	a	b	a'	b'	a''	b''	n°p	n°p'	n°f	Φf
CAST 400	165	117	200	153	235	187	-	1-112	6	10
CAST 450	185	131	219	167	255	201	-	1-112	6	10
CAST 500	205	146	241	182	275	216	1-112	1-112	8	12
CAST 560	229	164	265	200	299	234	1-112	1-112	8	12
CAST 630	256	183	292	219	326	253	1-112	2-112	10	12
CAST 710	288	205	332	249	368	285	1-125	2-125	10	12
CAST 800	322	229	366	273	402	309	1-125	2-125	10	12
CAST 900	361	256	405	300	441	336	1-125	2-125	10	12

ORIENTACIONES

H0	H1	H2	H3	H4	H5	H6	H7
RD0	RD45	RD90	RD135	RD180	RD225	RD270	RD315
LG0	LG45	LG90	LG135	LG180	LG225	LG270	LG315

H * La medida de la cota H (distancia entre el suelo y el eje) varía según las orientaciones

Para obtener las dimensiones del modelo 1000 consultar a nuestro equipo técnico.

Accesorios

Contrabrida aspiración

n° - Ø taladros

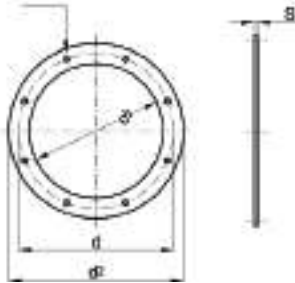

MOD.	d	d ¹	d ²	n°	Φ
CAST 400	219	185	255	8	M8
CAST 450	241	205	275	8	M8
CAST 500	265	229	299	8	M8
CAST 560	292	255	325	8	M8
CAST 630	332	286	366	8	M8
CAST 710	366	321	401	8	M8
CAST 800	405	361	441	8	M8
CAST 900	448	406	486	12	M10
CAST 1000	497	456	536	12	M10

Contrabrida impulsión

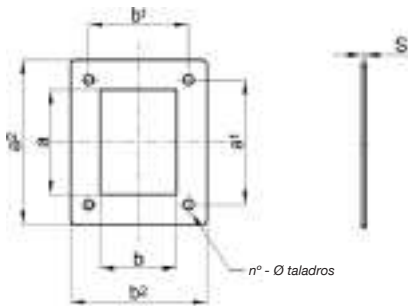

MOD.	a	b	a ¹	b ¹	a ²	b ²	n ¹ p	n ² p	n°	Φ	s
CAST 400	165	117	200	153	235	187	-	1-112	6	10	4
CAST 450	185	131	219	167	255	201	-	1-112	6	10	4
CAST 500	205	146	241	182	275	216	1-112	1-112	8	12	4
CAST 560	229	164	265	200	299	234	1-112	1-112	8	12	5
CAST 630	256	183	292	219	326	253	1-112	2-112	10	12	5
CAST 710	288	205	332	249	368	285	1-125	2-125	10	12	5
CAST 800	322	229	366	273	402	309	1-125	2-125	10	12	5
CAST 900	361	256	405	300	441	336	1-125	2-125	10	12	5
CAST 1000	404	288	448	332	484	362	2-126	3-127	14	12	5

Red protección en aspiración

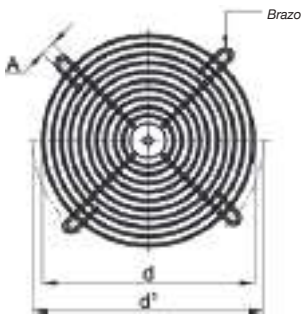

MOD.	d	d ¹	d ²	A	n°
CAST 400	185	219	255	9	4
CAST 450	205	241	275	11	4
CAST 500	229	265	299	11	4
CAST 560	255	292	325	11	4
CAST 630	286	332	366	11	8
CAST 710	321	366	401	11	8
CAST 800	361	405	441	11	8
CAST 900	406	448	486	11	8
CAST 1000	456	497	536	11	8

Junta anti vibratoria en aspiración

n° - Ø taladros

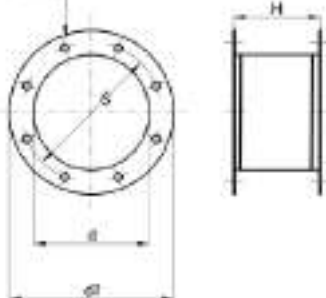

MOD.	d	d ¹	d ²	n°	Φ	H
CAST 400	119	185	255	8	M8	200
CAST 450	241	205	275	8	M8	200
CAST 500	265	229	299	8	M8	200
CAST 560	292	255	325	8	M8	200
CAST 630	332	286	366	8	M8	200
CAST 710	366	321	401	8	M8	200
CAST 800	405	361	441	8	M8	200
CAST 900	448	406	486	12	M10	200
CAST 1000	497	456	536	12	M10	200

LARGE SERIES

Accesorios

Junta anti vibratoria en impulsión

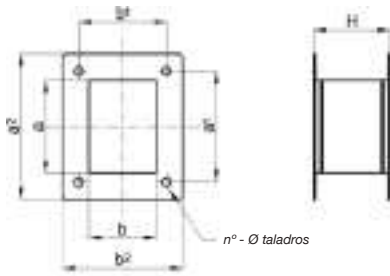

MOD.	a	b	a ¹	b ¹	a ²	b ²	n°p	n ² p	n°	Φ	H
CAST 400	165	117	200	153	235	187	-	1-112	6	10	200
CAST 450	185	131	219	167	255	201	-	1-112	6	10	200
CAST 500	205	146	241	182	275	216	1-112	1-112	8	12	200
CAST 560	229	164	265	200	299	234	1-112	1-112	8	12	200
CAST 630	256	183	292	219	326	253	1-112	2-112	10	12	200
CAST 710	288	205	332	249	368	285	1-125	2-125	10	12	200
CAST 800	322	229	366	273	402	309	1-125	2-125	10	12	200
CAST 900	361	256	405	300	441	336	1-125	2-125	10	12	200
CAST 1000	404	288	448	332	484	362	2-126	3-127	14	12	200

Amortiguadores

TIPO 1



TIPO 2

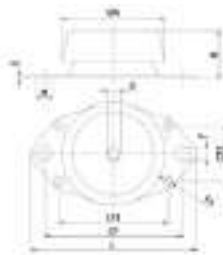

MOD.	MODELO AMORTIGUADORES	TIPO	αA	B	D	CF	CF1	CF2	F	αF1	L	M	S
CAST 400	CF 623110	1	67	33...34	10	76,5	-	-	9	-	90,5	16	2
CAST 450	CF 623110	1	67	33...34	10	76,5	-	-	9	-	90,5	16	2
CAST 500	CF 623110	1	67	33...34	10	76,5	-	-	9	-	90,5	16	2
CAST 560	CF 623110	1	67	33...34	10	76,5	-	-	9	-	90,5	16	2
CAST 630	CF 623110	1	67	33...34	10	76,5	-	-	9	-	90,5	16	2
CAST 710	CF 623110	1	67	33...34	10	76,5	-	-	9	-	90,5	16	2
CAST 800	CF 924512	2	92	44...45	12	120	98	50	10,5	8,5	130	15,5	2,5
CAST 900	CF 924512	2	92	44...45	12	120	98	50	10,5	8,5	130	15,5	2,5
CAST 1000	CF 924512	2	92	44...45	12	120	98	50	10,5	8,5	130	15,5	2,5

Silenciadores circulares

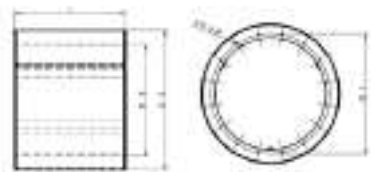

Los silenciadores se utilizan para bajar el nivel sonoro en instalaciones de acondicionamiento o ventilación, fabricados en acero cincado

- Bajo demanda: otras construcciones en diferentes materiales.

αD	αE	L	αI	F	αM	αD	αE	L	αI	F	αM
315	515	∅D,1,5∅D, 2∅D	355	8	M8	900	1100	∅D,1,5∅D, 2∅D	970	16	M10
355	555	∅D,1,5∅D, 2∅D	395	8	M8	1000	1200	∅D,1,5∅D, 2∅D	1070	16	M10
400	600	∅D,1,5∅D, 2∅D	450	8	M8	1120	1320	∅D,1,5∅D, 2∅D	1190	20	M10
450	650	∅D,1,5∅D, 2∅D	500	8	M8	1250	1450	∅D,1,5∅D, 2∅D	1320	20	M10
500	700	∅D,1,5∅D, 2∅D	560	12	M8	1400	1600	∅D,1,5∅D, 2∅D	1470	20	M10
560	760	∅D,1,5∅D, 2∅D	620	12	M8	1500	1700	∅D,1,5∅D, 2∅D	1570	20	M10
630	830	∅D,1,5∅D, 2∅D	690	12	M8	1600	1800	∅D,1,5∅D, 2∅D	1680	24	M14
710	910	∅D,1,5∅D, 2∅D	770	16	M8	1700	1900	∅D,1,5∅D, 2∅D	1780	24	M14
800	1000	∅D,1,5∅D, 2∅D	860	16	M8	1800	2000	∅D,1,5∅D, 2∅D	1880	24	M14

MOTOR DIRECTO

CMTB

Ventiladores centrífugos de pala abierta y simple aspiración de gran robustez con envolvente y turbina en chapa de acero

Diseñados para aire con mucho polvo y materiales en suspensión



* Las imágenes son solo a nivel ilustrativo, el producto puede variar en función del tamaño, especificaciones y posición.

Ventilador:

- Envolvente en chapa de acero.
- Turbina a reacción, en chapa de acero de gran robustez, especialmente diseñados para aire con mucho polvo y materiales en suspensión.
- Motor directamente acoplado.
- Con trampilla de inspección y limpieza a partir del tamaño 560.

Motor:

- Motores con eficiencia IE3 para potencias iguales o superiores a 0,75 kW, excepto monofásicos, 2 velocidades y 8 polos.
- Motores clase F con rodamientos a bolas. Protección IP55.
- Trifásicos 230/400 V 50 Hz (hasta 4 kW) y 400/690 V 50 Hz (potencias superiores a 4 kW).
- Temperatura máxima del aire a transportar: -25 °C +90 °C.

Acabado:

- Anticorrosivo en resina de poliéster polimerizada a 190 °C, previo desengrase con tratamiento nanotecnológico libre de fosfatos.

Bajo demanda:

- Bobinados especiales para diferentes tensiones.
- Ventilador preparado para transportar aire hasta +150 °C.
- Ejecuciones especiales para temperaturas +300 °C.
- Ventilador en acero inoxidable.
- Certificación ATEX Categoría 2.
- Acoplamiento elástico sistema 8.

Formas constructivas motor directo

SISTEMA 4

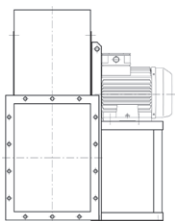

Accionamiento directo, turbina montada en el eje motor, montado sobre la silleta.

SISTEMA 5

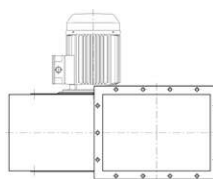

Accionamiento directo, turbina montada en el eje motor, motor de brida montado sobre la carcasa del ventilador.

SISTEMA 8

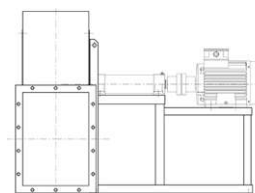

Accionamiento por acoplamiento elástico, turbina montada en el eje soporte, montado al motor mediante acoplamiento elástico. Todo montado conjuntamente sobre la silleta ventilador.

Orientaciones

RD 0 RD45 RD90 RD135 RD180 RD225 RD270 RD315

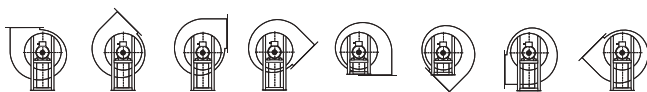

LG 0 LG45 LG90 LG135 LG180 LG225 LG270 LG315

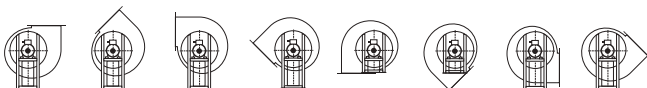

LARGE SERIES

MOTOR A TRANSMISIÓN

CMTB-X

Ventiladores centrífugos de pala abierta accionados a transmisión, equipados con motor eléctrico, conjunto de poleas, correas y protectores normalizados según norma ISO-13857

Diseñados para aire con mucho polvo y materiales en suspensión



Motor:

- Motores con eficiencia IE3.
- Motores clase F con rodamientos a bolas. Protección IP55.
- Trifásicos 230/400 V 50 Hz (hasta 4 kW) y 400/690 V 50 Hz (potencias superiores a 4 kW).
- Temperatura máxima del aire a transportar: -25 °C +90 °C.

Acabado:

- Anticorrosivo en resina de poliéster polimerizada a 190 °C, previo desengrase con tratamiento nanotecnológico libre de fosfatos.

Bajo demanda:

- Bobinados especiales para diferentes tensiones.
- Ventilador preparado para transportar aire hasta +300 °C.
- Ventilador en acero inoxidable.
- Certificación ATEX Categoría 2.
- Acoplamiento elástico sistema 8.

Ventilador:

- Envoltorio en chapa de acero.
- Turbina a reacción, en chapa de acero de gran robustez, especialmente diseñados para aire con mucho polvo y materiales en suspensión.
- Motor montado sobre bancada general.
- Con trampilla de inspección y limpieza a partir del tamaño 560.

* Las imágenes son solo a nivel ilustrativo, el producto puede variar en función del tamaño, especificaciones y posición.

Formas constructivas motor a transmisión

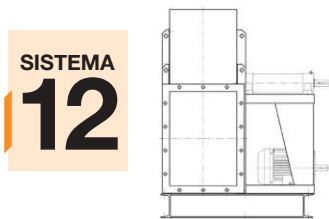

Accionamiento a transmisión, igual al SISTEMA 1, con el motor y ventilador montados en la bancada común. Posiciones de motor "W" o "Z" y excepcionalmente "X" o "Y".

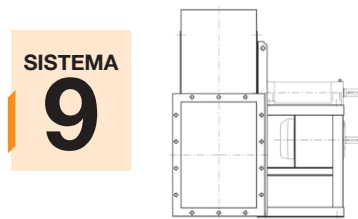

Accionamiento a transmisión, igual al SISTEMA 1, con el motor montado en el lateral de la silleta, en posición "W" o "Z".

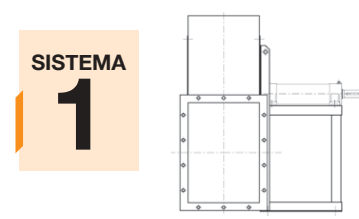

Accionamiento a transmisión, turbina montada en el eje soporte. Soporte montado sobre la silleta.

Orientaciones

RD 0 RD45 RD90 RD135 RD180 RD225 RD270 RD315

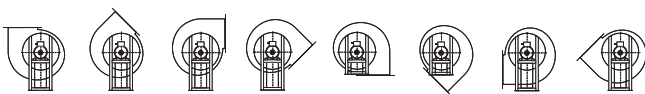

LG 0 LG45 LG90 LG135 LG180 LG225 LG270 LG315

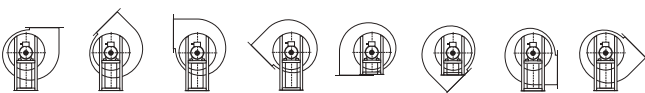

SELECCIÓN RÁPIDA SISTEMA 4

Características en impulsión

Modelo	Frame	kW ass	kW inst.	r.p.m.	dB	V m³/s																				
						0,16	0,18	0,2	0,23	0,26	0,3	0,33	0,36	0,4	0,46	0,52	0,58	0,66	0,75	0,83						
						Pt kgf/m²=mmH₂O																				
CMTB 250	71 B/2	0,53	0,55	2810	75	99	97	94	92	90	89	78														
CMTB 280	80 B/2	0,9	1,1	2820	80							135	134	132	130	125	122	120	119							
CMTB 310	90 S/2	1,3	1,5	2840	82											175	174	172	165	155	145	140				
CMTB 350	112 M/2	3,7	4	2860	90																	230	229	228	226	224
CMTB 400	132 SB/2	7,1	7,5	2900	92																284					

Modelo	Frame	kW ass	kW inst.	r.p.m.	dB	V m³/s										
						0,93	1	1,2	1,35	1,5	1,8	1,9	2			
						Pt kgf/m²=mmH₂O										
CMTB 350	112 M/2	3,7	4	2860	90	220	218									
CMTB 400	132 SB/2	7,1	7,5	2900	92	284	284	280	276	274	270					
CMTB 450	160 MA/2	10,5	11	2910	95							365	365	365	360	355
CMTB 470	160 MB/2	14,2	15	2930	97							415	410	405	400	390

Margen sobre el caudal ±5%
Margen del nivel sonoro +3...5db

Características en aspiración

Modelo	Frame	kW ass	kW inst.	r.p.m.	dB	V m³/s																				
						0,16	0,18	0,2	0,23	0,26	0,3	0,33	0,36	0,4	0,46	0,52	0,58	0,66	0,75	0,83						
						Pt kgf/m²=mmH₂O																				
CMTB 250	71 B/2	0,53	0,55	2810	78	96	94	91	89	87	86	76														
CMTB 280	80 B/2	0,9	1,1	2820	83							131	130	128	126	121	118	116	115							
CMTB 310	90 S/2	1,3	1,5	2840	85											170	169	167	160	150	141	136				
CMTB 350	112 M/2	3,7	4	2860	93																	223	222	221	219	217
CMTB 400	132 SB/2	7,1	7,5	2900	95																275					

Modelo	Frame	kW ass	kW inst.	r.p.m.	dB	V m³/s										
						0,93	1	1,2	1,35	1,5	1,8	1,9	2			
						Pt kgf/m²=mmH₂O										
CMTB 350	112 M/2	3,7	4	2860	93	213	211									
CMTB 400	132 SB/2	7,1	7,5	2900	95	275	275	272	268	266	262					
CMTB 450	160 MA/2	10,5	11	2910	98							354	354	354	349	344
CMTB 470	160 MB/2	14,2	15	2930	100							403	398	393	388	378

Margen sobre el caudal ±5%
Margen del nivel sonoro +3...5db

Curvas Características

CMTB 250

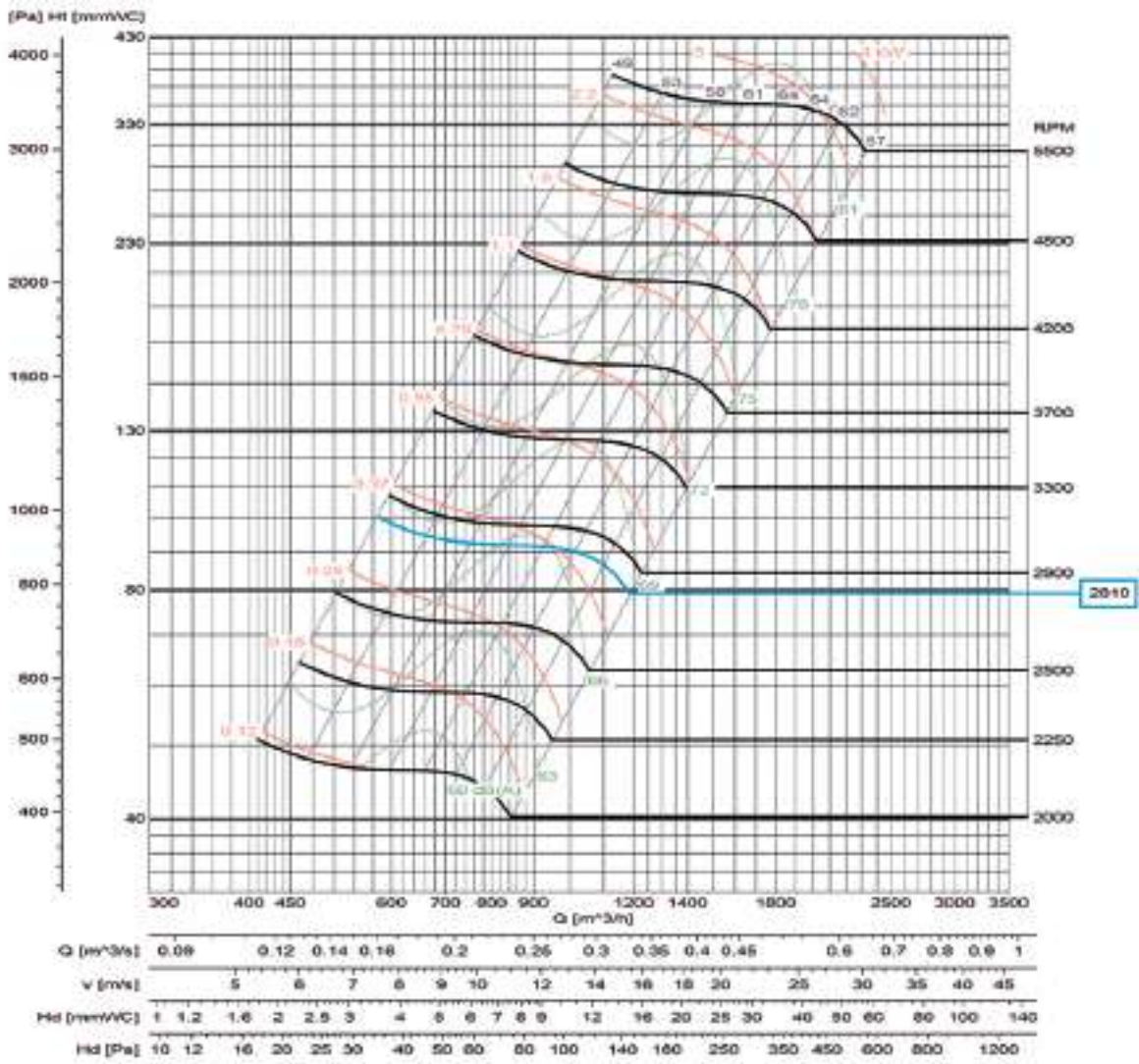

Margen sobre el caudal $\pm 5\%$
 Margen del nivel sonoro $+3...5\text{db}$
 Margen kW absorbidos $\pm 3\%$

Características en impulsión.

Rpm

Características para:
 sistema 4 y 5 en motor
 directo con 2/4/6/8 polos
 según modelo.

Curvas Características

CMTB 280

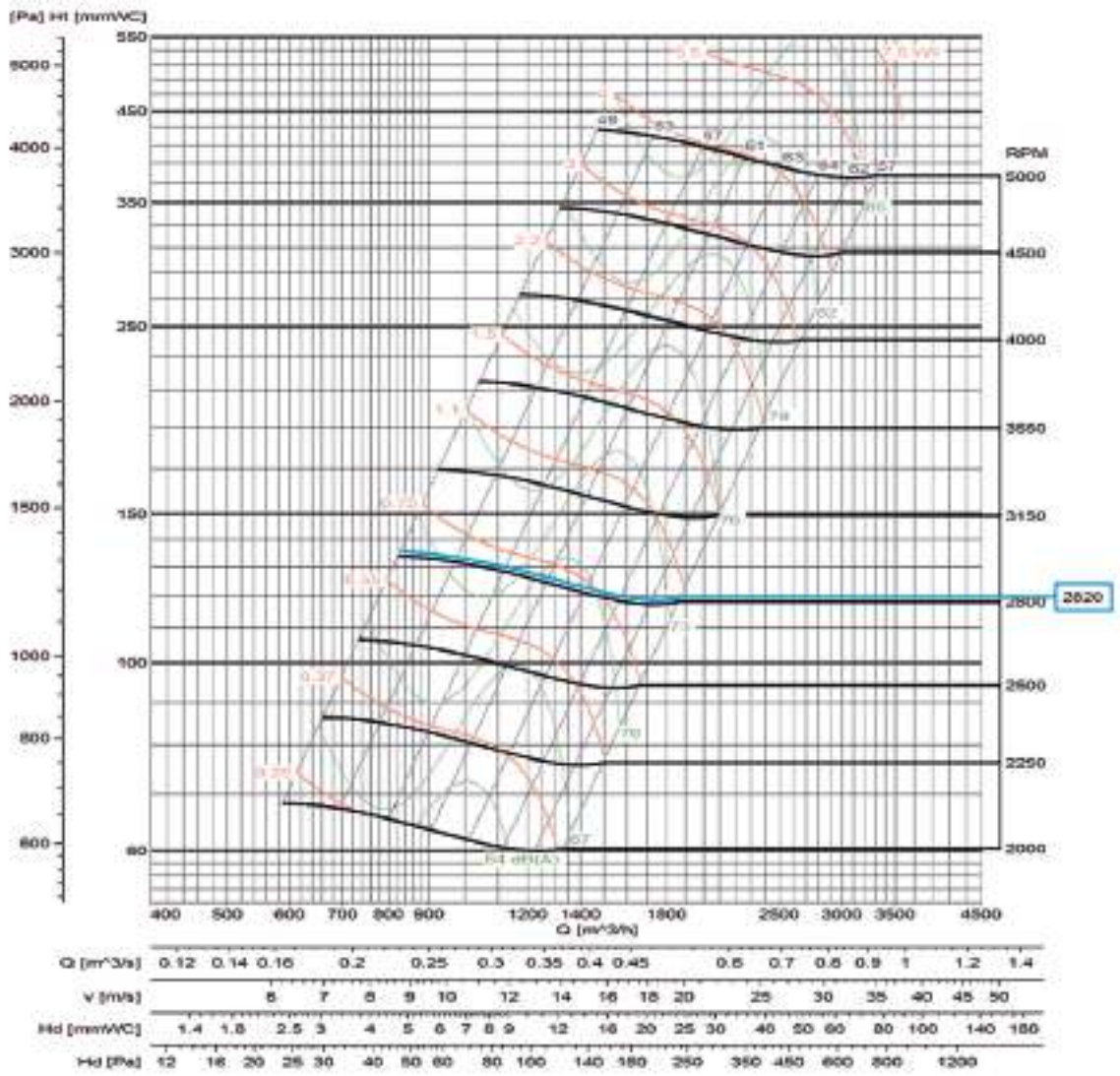

LARGE SERIES

Margen sobre el caudal ± 5 %
 Margen del nivel sonoro +3...5db
 Margen kW absorbidos ± 3%

Características en impulsión.

Rpm Características para:
 sistema 4 y 5 en motor
 directo con 2/4/6/8 polos
 según modelo.

Curvas Características

CMTB 310

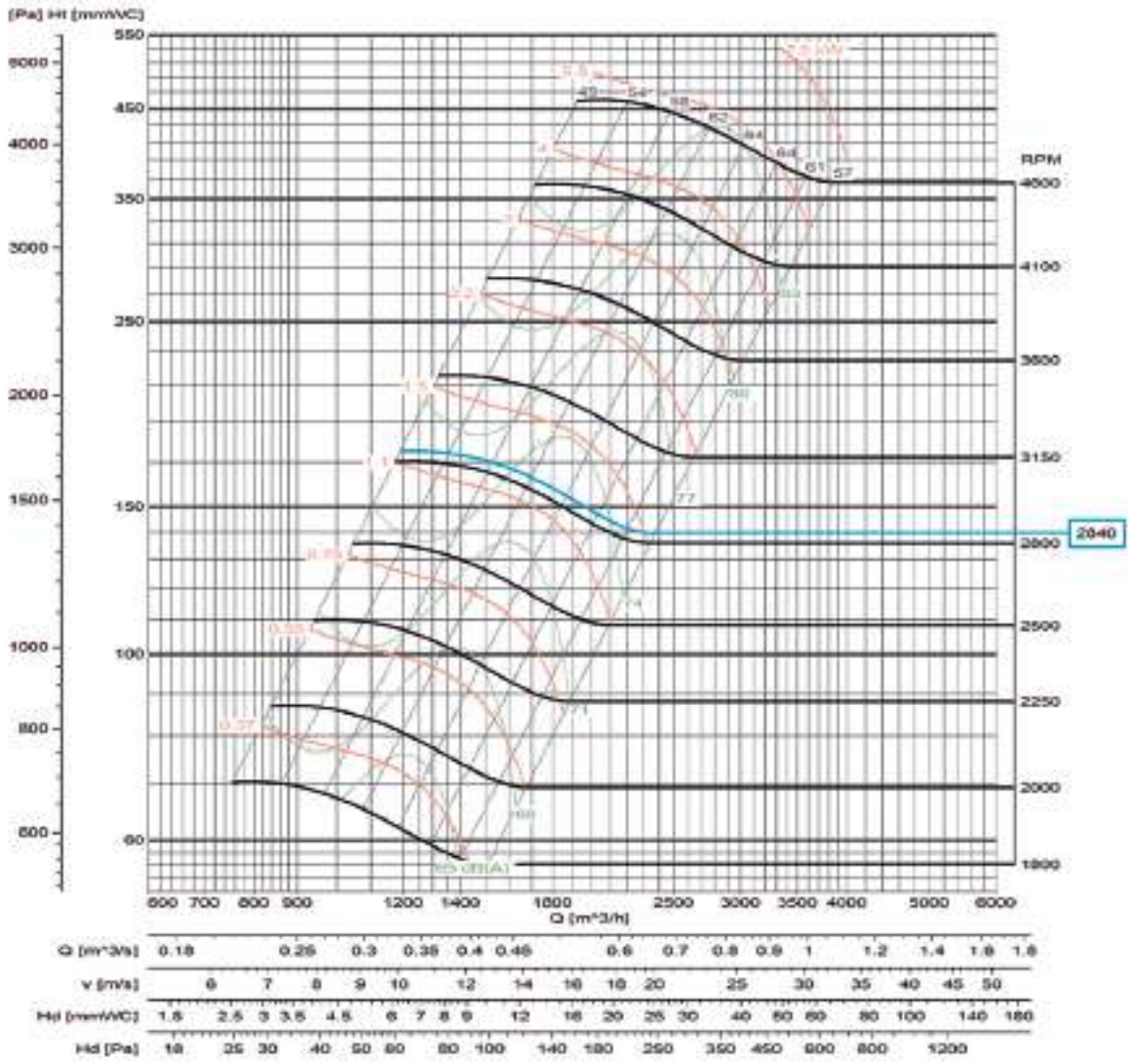

Margen sobre el caudal $\pm 5\%$
 Margen del nivel sonoro $+3...5\text{db}$
 Margen kW absorbidos $\pm 3\%$

Características en impulsión.

Rpm

Características para:
 sistema 4 y 5 en motor
 directo con 2/4/6/8 polos
 según modelo.

Curvas Características

CMTB 350

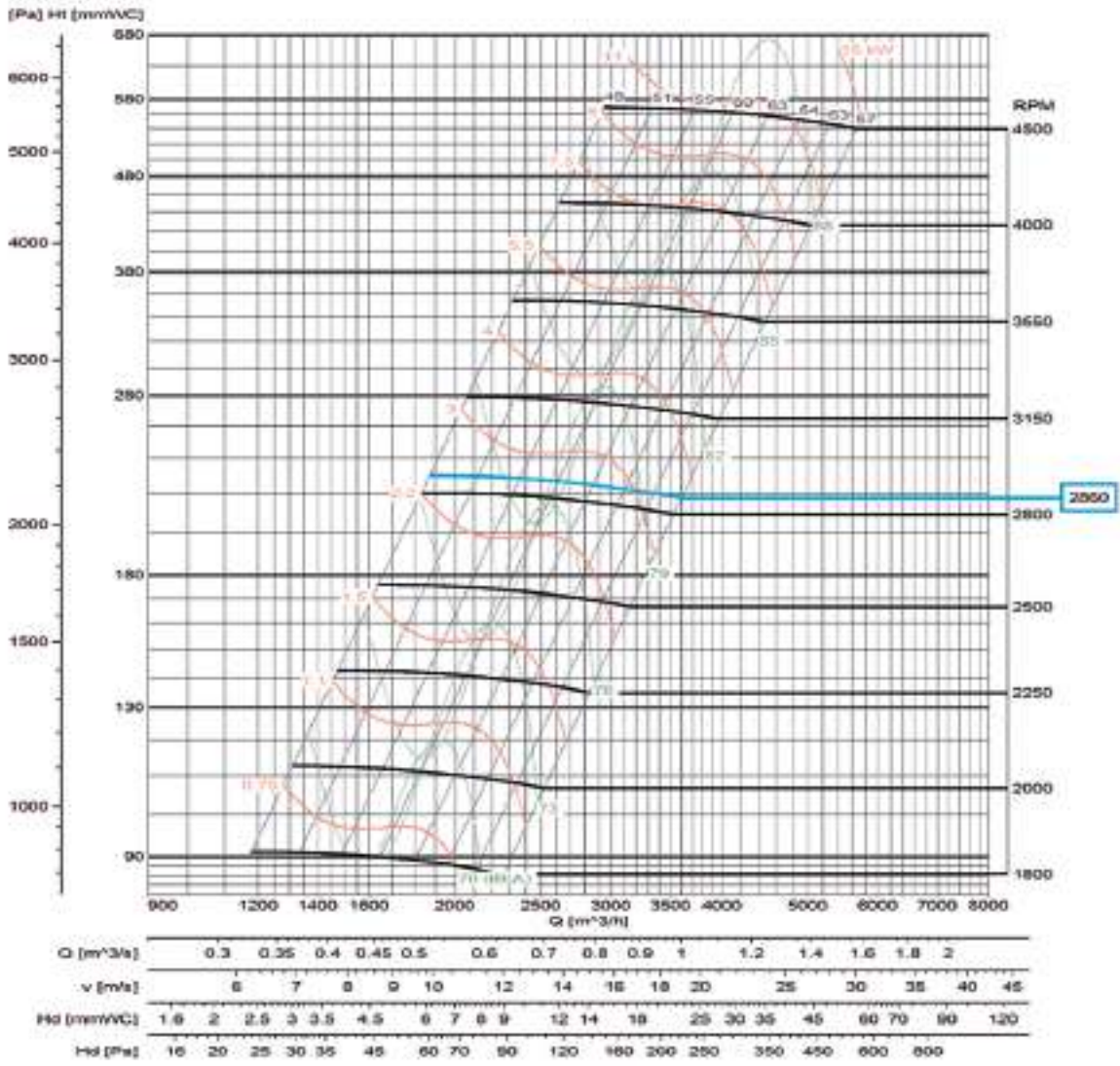

LARGE SERIES

Margen sobre el caudal ± 5 %
 Margen del nivel sonoro +3...5db
 Margen kW absorbidos ± 3%

Características en impulsión.

Rpm

Características para:
 sistema 4 y 5 en motor
 directo con 2/4/6/8 polos
 según modelo.

Curvas Características

CMTB 400

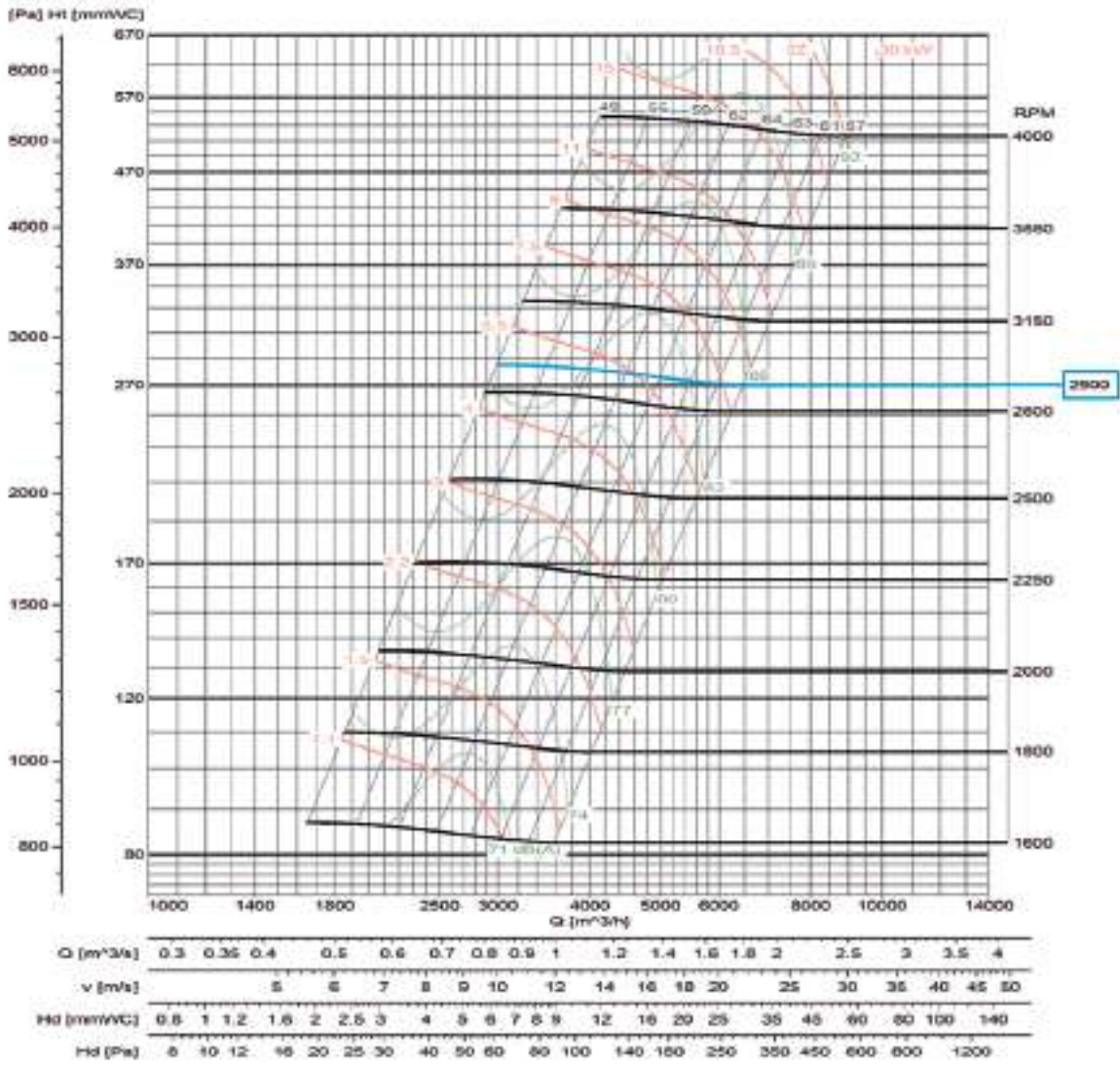

Margen sobre el caudal ± 5 %
 Margen del nivel sonoro +3...5db
 Margen kW absorbidos ± 3%

Características en impulsión.

Rpm

Características para:
 sistema 4 y 5 en motor
 directo con 2/4/6/8
 según modelo.

Curvas Características

CMTB 450

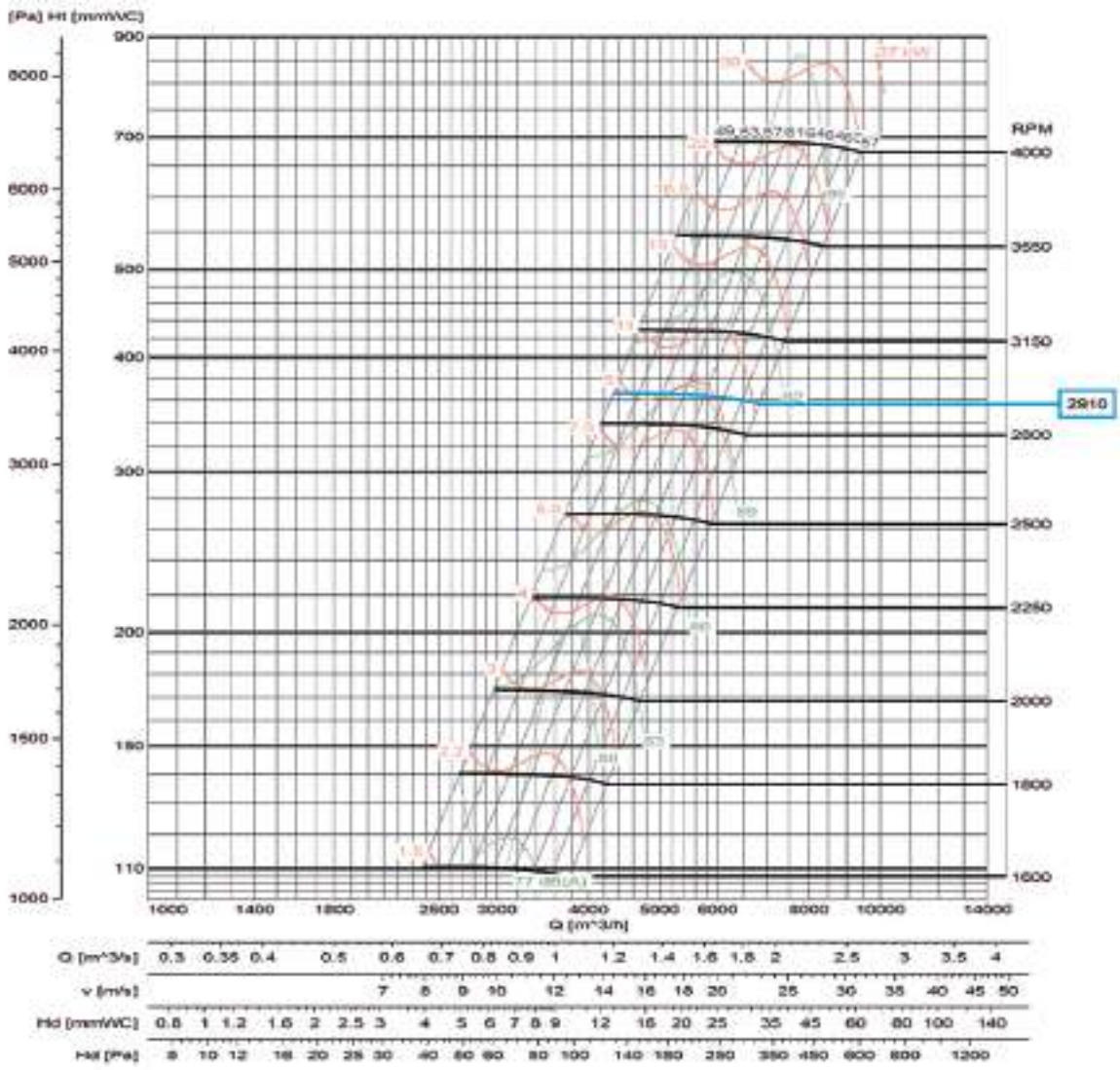

LARGE SERIES

Margen sobre el caudal ± 5 %
 Margen del nivel sonoro +3...5db
 Margen kW absorbidos ± 3%

Características en impulsión.

Rpm

Características para:
 sistema 4 y 5 en motor
 directo con 2/4/6/8 polos
 según modelo.

Curvas Características

CMTB 470

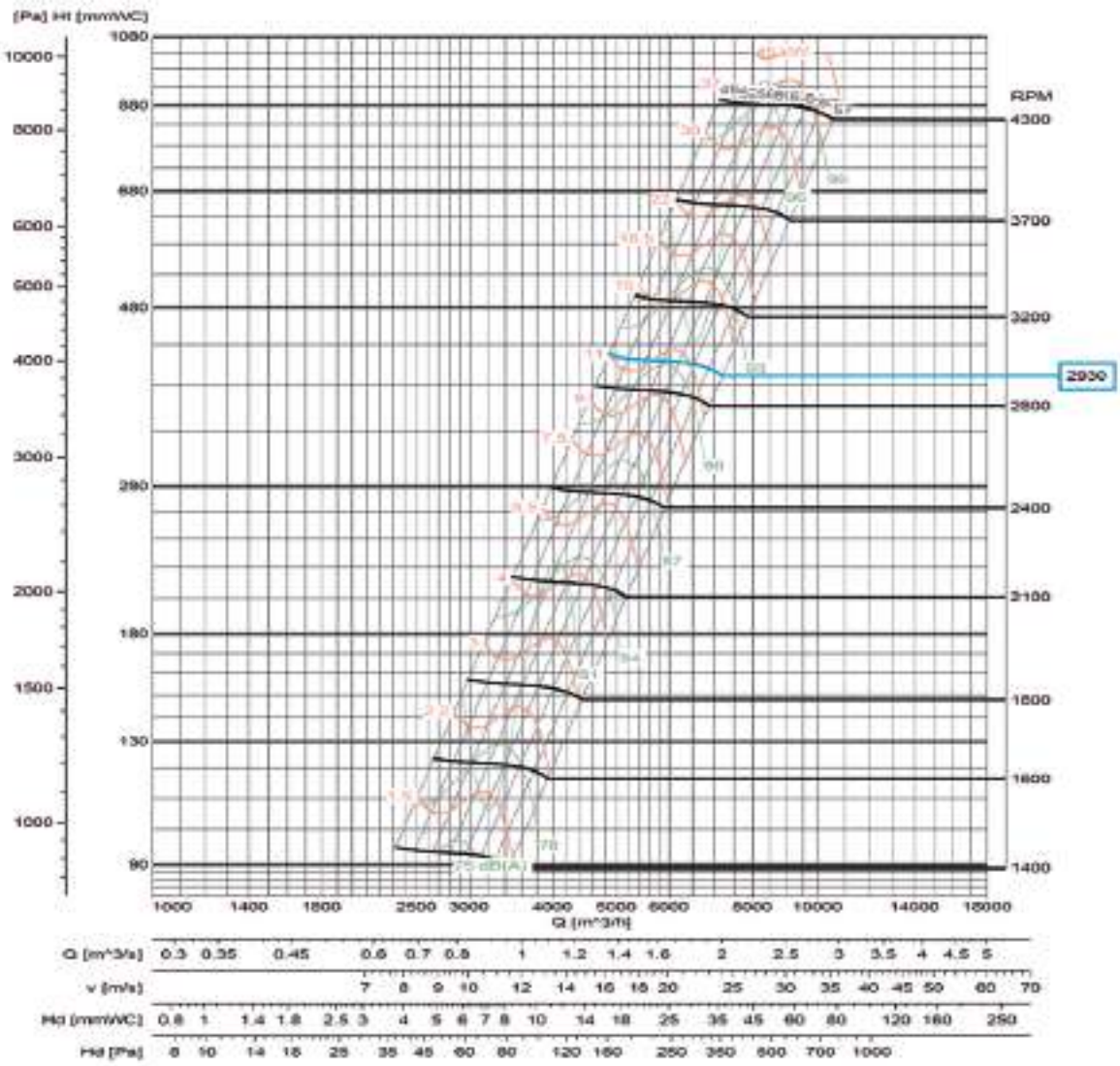

Margen sobre el caudal $\pm 5\%$
 Margen del nivel sonoro $+3...5db$
 Margen kW absorbidos $\pm 3\%$

Características en impulsión.

Rpm

Características para:
 sistema 4 y 5 en motor
 directo con 2/4/6/8
 según modelo.

Dimensiones mm

CMTB 250...470

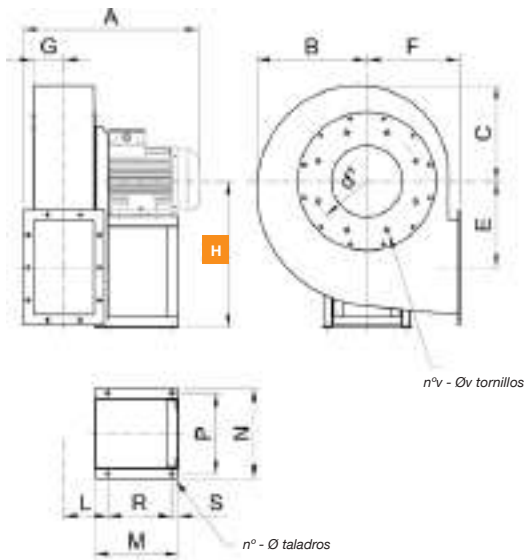

BOCA DE IMPULSIÓN

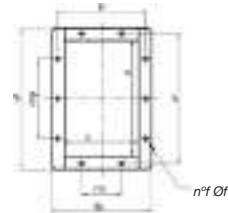

ORIENTACIONES

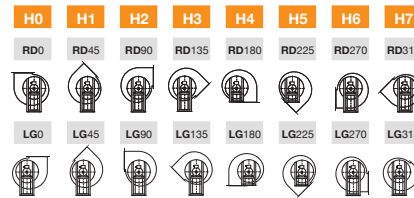

H * La medida de la cota H (distancia entre el suelo y el eje) varía según las orientaciones

MOD.	FRAME	A*	B	C	E	F	G	HO-1-2-3	H4-5	H6-7	L	M*	N	P	R*	S
CMTB 250	71 B/2	375	215	190	160	180	67	315	180	315	111	190	244	220	115	25
CMTB 280	80 B/2	415	255	225	200	220	74	375	220	375	118	190	244	220	115	25
CMTB 310	90 S/2	465	285	245	225	240	86	400	240	400	125	215	269	245	140	25
CMTB 350	112 M/2	540	330	295	250	290	104	500	290	500	146	260	312	280	185	25
CMTB 400	132 SB/2	675	425	370	330	355	118	560	355	560	169	320	342	310	245	25
CMTB 450	160 MA/2	745	425	370	330	355	118	560	355	560	169	425	490	450	345	30
CMTB 470	160 MB/2	745	425	370	330	355	118	560	355	560	169	425	490	450	345	30

BOCA IMPULSIÓN

MOD.	n°	Φ	d¹	n°v	Φv	a	b	a¹	b¹	a²	b²	n°p	n°p	n°f	Φf	kg	WD²
CMTB 250	4	10	200	8	M6	184	116	219	151	254	186	-	1-112	6	12	25	0,05
CMTB 280	4	10	241	8	M6	204	129	241	166	274	199	-	1-112	6	12	35	0,08
CMTB 310	4	10	265	8	M6	229	144	265	181	299	214	1-112	1-112	8	12	45	0,2
CMTB 350	4	12	332	8	M8	284	185	332	232	364	265	1-125	2-125	10	12	70	0,6
CMTB 400	4	12	405	8	M8	360	231	405	274	440	311	1-125	2-125	10	12	110	1
CMTB 450	4	14	405	8	M8	360	231	405	274	440	311	1-125	2-125	10	12	145	1,3
CMTB 470	4	14	405	8	M8	360	231	405	274	440	311	1-125	2-125	10	12	150	1,6

(*) Para construcciones a "ALTA TEMP" cotas "A-M-R" + 50 mm.
(kg) Peso ventilador con motor.
WD² = Momento de inercia del rodete, expresado en Kg x m²

Para obtener las dimensiones de los sistemas 1, 9 y 12 consultar a nuestro equipo técnico.

Accesorios

Contrabrida aspiración

n° - Ø taladros

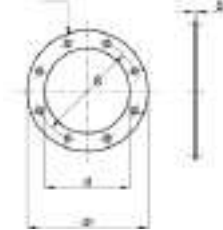

MOD.	d	d ¹	d ²	n°	Φ	s	kg
CMTB 250	165	200	235	8	9	4	0,65
CMTB 280	205	241	275	8	9	4	0,75
CMTB 310	229	265	299	8	9	4	0,8
CMTB 350	286	332	366	8	11	5	1,6
CMTB 400	361	405	441	8	11	5	2
CMTB 450	361	405	441	8	11	5	2
CMTB 470	361	405	441	8	11	5	2

Junta anti vibratoria en aspiración

n° - Ø taladros

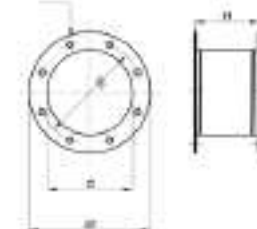

MOD.	d	d ¹	d ²	n°	Φ	H	kg
CMTB 250	165	200	235	8	9	200	1,5
CMTB 280	205	241	275	8	9	200	1,7
CMTB 310	229	265	299	8	9	200	1,8
CMTB 350	286	332	366	8	11	200	3,5
CMTB 400	361	405	441	8	11	200	4,3
CMTB 450	361	405	441	8	11	200	4,3
CMTB 470	361	405	441	8	11	200	4,3

Contrabrida impulsión

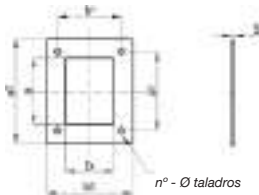

MOD.	a	b	a ¹	b ¹	a ²	b ²	n ¹ p	n ² p	n ⁰	Φ	s	kg
CMTB 250	184	116	219	151	254	186	-	1-112	6	12	4	0,8
CMTB 280	204	129	241	166	274	199	-	1-112	6	12	4	0,9
CMTB 310	229	144	265	181	299	214	1-112	1-112	8	12	4	1
CMTB 350	284	185	332	232	364	265	1-125	2-125	10	12	5	1,7
CMTB 400	360	231	405	274	440	311	1-125	2-125	10	12	5	2
CMTB 450	360	231	405	274	440	311	1-125	2-125	10	12	5	2
CMTB 470	360	231	405	274	440	311	1-125	2,125	10	12	5	2

Junta anti vibratoria en impulsión

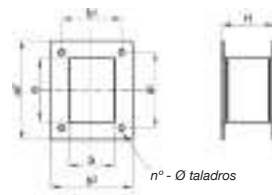

MOD.	a	b	a ¹	b ¹	a ²	b ²	n ¹ p	n ² p	n ⁰	Φ	H	kg
CMTB 250	184	116	219	151	254	186	-	1-112	6	12	200	1,8
CMTB 280	204	129	241	166	274	199	-	1-112	6	12	200	2
CMTB 310	229	144	265	181	299	214	1-112	1-112	8	12	200	2,2
CMTB 350	284	185	332	232	364	265	1-125	2-125	10	12	200	3,7
CMTB 400	360	231	405	274	440	311	1-125	2-125	10	12	200	4,3
CMTB 450	360	231	405	274	440	311	1-125	2-125	10	12	200	4,3
CMTB 470	360	231	405	274	440	311	1-125	2-125	10	12	200	4,3

Red protección en aspiración

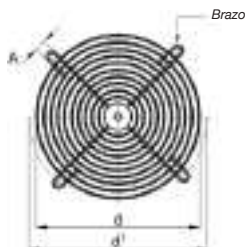

MOD.	d	d ¹	A	n°	kg
CMTB 250	165	200	9	4	0,15
CMTB 280	205	241	9	4	0,2
CMTB 310	229	265	9	4	0,25
CMTB 350	286	332	11	4	0,35
CMTB 400	361	405	11	4	0,7
CMTB 450	361	405	11	4	0,7
CMTB 470	361	405	11	4	0,7

Silenciadores circulares

Los silenciadores se utilizan para bajar el nivel sonoro en instalaciones de acondicionamiento o ventilación, fabricados en acero cincado

- Bajo demanda: otras construcciones en diferentes materiales.



øD	øE	L	øI	F	øM	øD	øE	L	øI	F	øM
315	515	ØD,1.5ØD, 2ØD	355	8	M8	900	1100	ØD,1.5ØD, 2ØD	970	16	M10
355	555	ØD,1.5ØD, 2ØD	395	8	M8	1000	1200	ØD,1.5ØD, 2ØD	1070	16	M10
400	600	ØD,1.5ØD, 2ØD	450	8	M8	1120	1320	ØD,1.5ØD, 2ØD	1190	20	M10
450	650	ØD,1.5ØD, 2ØD	500	8	M8	1250	1450	ØD,1.5ØD, 2ØD	1320	20	M10
500	700	ØD,1.5ØD, 2ØD	560	12	M8	1400	1600	ØD,1.5ØD, 2ØD	1470	20	M10
560	760	ØD,1.5ØD, 2ØD	620	12	M8	1500	1700	ØD,1.5ØD, 2ØD	1570	20	M10
630	830	ØD,1.5ØD, 2ØD	690	12	M8	1600	1800	ØD,1.5ØD, 2ØD	1680	24	M14
710	910	ØD,1.5ØD, 2ØD	770	16	M8	1700	1900	ØD,1.5ØD, 2ØD	1780	24	M14
800	1000	ØD,1.5ØD, 2ØD	860	16	M8	1800	2000	ØD,1.5ØD, 2ØD	1880	24	M14

Amortiguadores

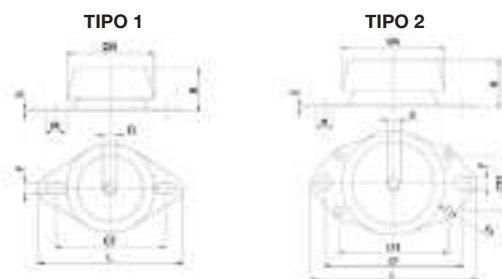

MOD.	MODELO AMORTIGUADORES	TIPO	øA	B	D	CF	CF1	CF2	F	øF1	L	M	S
CMTB 250	CF 623110	1	67	33...34	10	76,5	-	-	9	-	90,5	16	2
CMTB 280	CF 623110	1	67	33...34	10	76,5	-	-	9	-	90,5	16	2
CMTB 310	CF 623110	1	67	33...34	10	76,5	-	-	9	-	90,5	16	2
CMTB 350	CF 623110	1	67	33...34	10	76,5	-	-	9	-	90,5	16	2
CMTB 400	CF 623110	1	67	33...34	10	76,5	-	-	9	-	90,5	16	2
CMTB 450	CF 924512	2	92	44...45	12	120	98	50	10,5	8,5	130	15,5	2,5
CMTB 470	CF 924512	2	92	44...45	12	120	98	50	10,5	8,5	130	15,5	2,5

MOTOR DIRECTO

CMTC

Ventiladores centrífugos de pala abierta y simple aspiración de gran robustez con envolvente y turbina en chapa de acero

Diseñados para aire con mucho polvo y materiales en suspensión



* Las imágenes son solo a nivel ilustrativo, el producto puede variar en función del tamaño, especificaciones y posición.

Ventilador:

- Envolvente en chapa de acero.
- Turbina a reacción, en chapa de acero de gran robustez, especialmente diseñados para aire con mucho polvo y materiales en suspensión.
- Motor directamente acoplado.
- Con trampilla de inspección y limpieza a partir del tamaño 560.
- Carcasa soldada en continuo a partir del tamaño 800.

Motor:

- Motores con eficiencia IE3 para potencias iguales o superiores a 0,75 kW, excepto monofásicos, 2 velocidades y 8 polos.
- Motores clase F con rodamientos a bolas. Protección IP55.
- Trifásicos 230/400 V 50 Hz (hasta 4 kW) y 400/690 V 50 Hz (potencias superiores a 4 kW).
- Temperatura máxima del aire a transportar: -25 °C +90 °C.

Acabado:

- Anticorrosivo en resina de poliéster polimerizada a 190 °C, previo desengrase con tratamiento nanotecnológico libre de fosfatos.

Bajo demanda:

- Bobinados especiales para diferentes tensiones.
- Ventilador preparado para transportar aire hasta +150 °C.
- Ejecuciones especiales para temperaturas +300 °C.
- Ventilador en acero inoxidable.
- Certificación ATEX Categoría 2.
- Acoplamiento elástico sistema 8.

Formas constructivas motor directo

SISTEMA

4

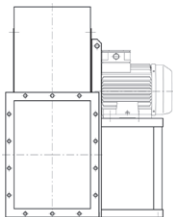

Accionamiento directo, turbina montada en el eje motor, montado sobre la silleta.

SISTEMA

5

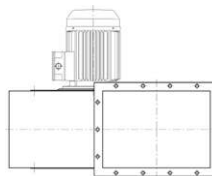

Accionamiento directo, turbina montada en el eje motor, motor de brida montado sobre la carcasa del ventilador.

SISTEMA

8

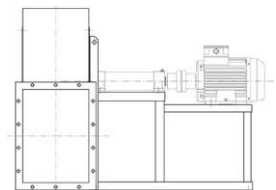

Accionamiento por acoplamiento elástico, turbina montada en el eje soporte, montado al motor mediante acoplamiento elástico. Todo montado conjuntamente sobre la silleta ventilador.

Orientaciones

RD 0 RD45 RD90 RD135 RD180 RD225 RD270 RD315

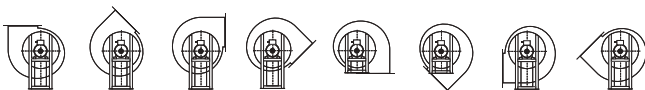

LG 0 LG45 LG90 LG135 LG180 LG225 LG270 LG315

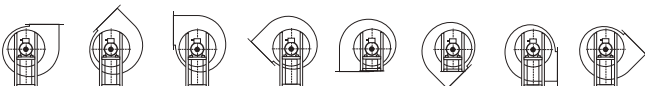

LARGE SERIES

MOTOR A TRANSMISIÓN

CMTC-X

Ventiladores centrífugos de pala abierta accionados a transmisión, equipados con motor eléctrico, conjunto de poleas, correas y protectores normalizados según norma ISO-13857

Diseñados para aire con mucho polvo y materiales en suspensión



Motor:

- Motores con eficiencia IE3.
- Motores clase F con rodamientos a bolas. Protección IP55.
- Trifásicos 230/400 V 50 Hz (hasta 4 kW) y 400/690 V 50 Hz (potencias superiores a 4 kW).
- Temperatura máxima del aire a transportar: -25 °C +90 °C.

Acabado:

- Anticorrosivo en resina de poliéster polimerizada a 190 °C, previo desengrase con tratamiento nanotecnológico libre de fosfatos.

Bajo demanda:

- Bobinados especiales para diferentes tensiones.
- Ventilador preparado para transportar aire hasta +300 °C.
- Ventilador en acero inoxidable.
- Certificación ATEX Categoría 2.
- Acoplamiento elástico sistema 8.

Ventilador:

- Envoltorio en chapa de acero.
- Turbina a reacción, en chapa de acero de gran robustez, especialmente diseñados para aire con mucho polvo y materiales en suspensión.
- Motor montado sobre bancada general.
- Con trampilla de inspección y limpieza a partir del tamaño 560.
- Carcasa soldada en continuo a partir del tamaño 800.

* Las imágenes son solo a nivel ilustrativo, el producto puede variar en función del tamaño, especificaciones y posición.

Formas constructivas motor a transmisión

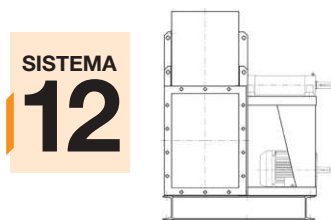

Accionamiento a transmisión, igual al SISTEMA 1, con el motor y ventilador montados en la bancada común. Posiciones de motor "W" o "Z" y excepcionalmente "X" o "Y".



Accionamiento a transmisión, igual al SISTEMA 1, con el motor montado en el lateral de la silleta, en posición "W" o "Z".

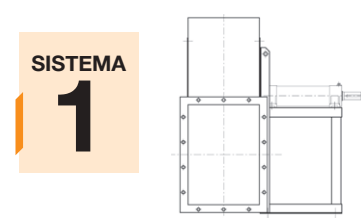

Accionamiento a transmisión, turbina montada en el eje soporte. Soporte montado sobre la silleta.

Orientaciones

RD 0 RD45 RD90 RD135 RD180 RD225 RD270 RD315

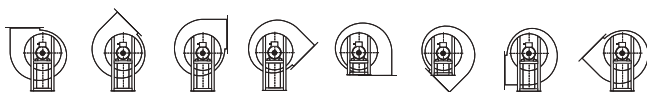

LG 0 LG45 LG90 LG135 LG180 LG225 LG270 LG315

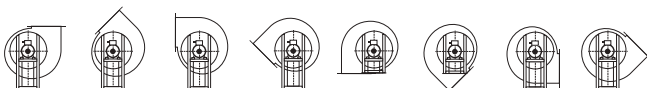

SELECCIÓN RÁPIDA SISTEMA 4**Características en impulsión**

Modelo	Frame	kW ass	kW inst.	r.p.m.	dB	V m ³ /s																	
						0,46	0,52	0,58	0,67	0,75	0,83	0,93	1,05	1,2	1,3	1,5	1,7	1,85	2,05	2,3			
						Pt kgf/m ² =mmH ₂ O																	
CMTC 630	112 M/4	3,8	4	1420	72					185	185	182	175	166	155	140							
CMTC 670	132 S/4	5,3	5,5	1430	74							215	212	210	200	193	185	172					
CMTC 700	132 MA/4	6,9	7,5	1430	76							240	240	235	223	210	195	180					
CMTC 750	160 M/4	10,5	11	1465	79											295	290	285	275	260			
CMTC 800	160 L/4	14	15	1465	80																330	328	319
CMTC 630	90 L/6	1	1,1	910	64	78	78	77	74	71	66	60											
CMTC 670	112 M/6	1,5	2,2	940	65				93	93	91	87	84	81	75								
CMTC 700	112 M/6	1,9	2,2	940	67				103	103	100	94	90	84	77								
CMTC 750	132 MA/6	3	4	950	70							128	126	124	119	113	106	98					
CMTC 800	132 MB/6	4	5,5	950	71									143	142	139	132	126	119	109			
CMTC 835	132 MB/6	5	5,5	950	73												138	137	133	127			
CMTC 855	160 M/6	5,9	7,5	960	74																139	132	

Modelo	Frame	kW ass	kW inst.	r.p.m.	dB	V m ³ /s										
						2,6	3	3,3	3,75	4,2	4,7	5,3				
						Pt kgf/m ² =mmH ₂ O										
CMTC 750	160 M/4	10,5	11	1465	79	245	225									
CMTC 800	160 L/4	14	15	1465	80	303	290	274	252							
CMTC 835	180 M/4	17,8	18,5	1470	82	320	318	307	294	275						
CMTC 855	180 L/4	21	22	1470	83			320	305	280	250	225				
CMTC 835	132 MB/6	5	5,5	950	73	119										
CMTC 855	160 M/6	5,9	7,5	960	74	121	108	97								

Margen sobre el caudal ±5%
Margen del nivel sonoro +3...5db

Características en aspiración

Modelo	Frame	kW ass	kW inst.	r.p.m.	dB	V m ³ /s																	
						0,46	0,52	0,58	0,67	0,75	0,83	0,93	1,05	1,2	1,3	1,5	1,7	1,85	2,05	2,3			
						Pt kgf/m ² =mmH ₂ O																	
CMTC 630	112 M/4	3,8	4	1420	75					167	167	164	158	149	140	126							
CMTC 670	132 S/4	5,3	5,5	1430	77							194	191	189	180	174	167	155					
CMTC 700	132 MA/4	6,9	7,5	1430	79									216	216	212	201	189	176	162			
CMTC 750	160 M/4	10,5	11	1465	81												266	261	257	248	234		
CMTC 800	160 L/4	14	15	1465	83																297	295	287
CMTC 630	90 L/6	1	1,1	910	67	70	70	69	67	64	59	54											
CMTC 670	112 M/6	1,5	2,2	940	67				84	84	82	78	76	73	68								
CMTC 700	112 M/6	1,9	2,2	940	70				93	93	90	85	81	76	69								
CMTC 750	132 MA/6	3	4	950	73							115	113	112	107	102	95	88					
CMTC 800	132 MB/6	4	5,5	950	74									129	128	125	119	113	107	98			
CMTC 835	132 MB/6	5	5,5	950	76													124	123	120	114		
CMTC 855	160 M/6	5,9	7,5	960	77																125	119	

Modelo	Frame	kW ass	kW inst.	r.p.m.	dB	V m ³ /s										
						2,6	3	3,3	3,75	4,2	4,7	5,3				
						Pt kgf/m ² =mmH ₂ O										
CMTC 750	160 M/4	10,5	11	1465	81	221	203									
CMTC 800	160 L/4	14	15	1465	83	273	261	247	227							
CMTC 835	180 M/4	17,8	18,5	1470	85	288	286	276	265	248						
CMTC 855	180 L/4	21	22	1470	85			288	275	252	225	203				
CMTC 835	132 MB/6	5	5,5	950	76	107										
CMTC 855	160 M/6	5,9	7,5	960	77	109	97	87								

Margen sobre el caudal ±5%
Margen del nivel sonoro +3...5db

Curvas Características

CMTC 630

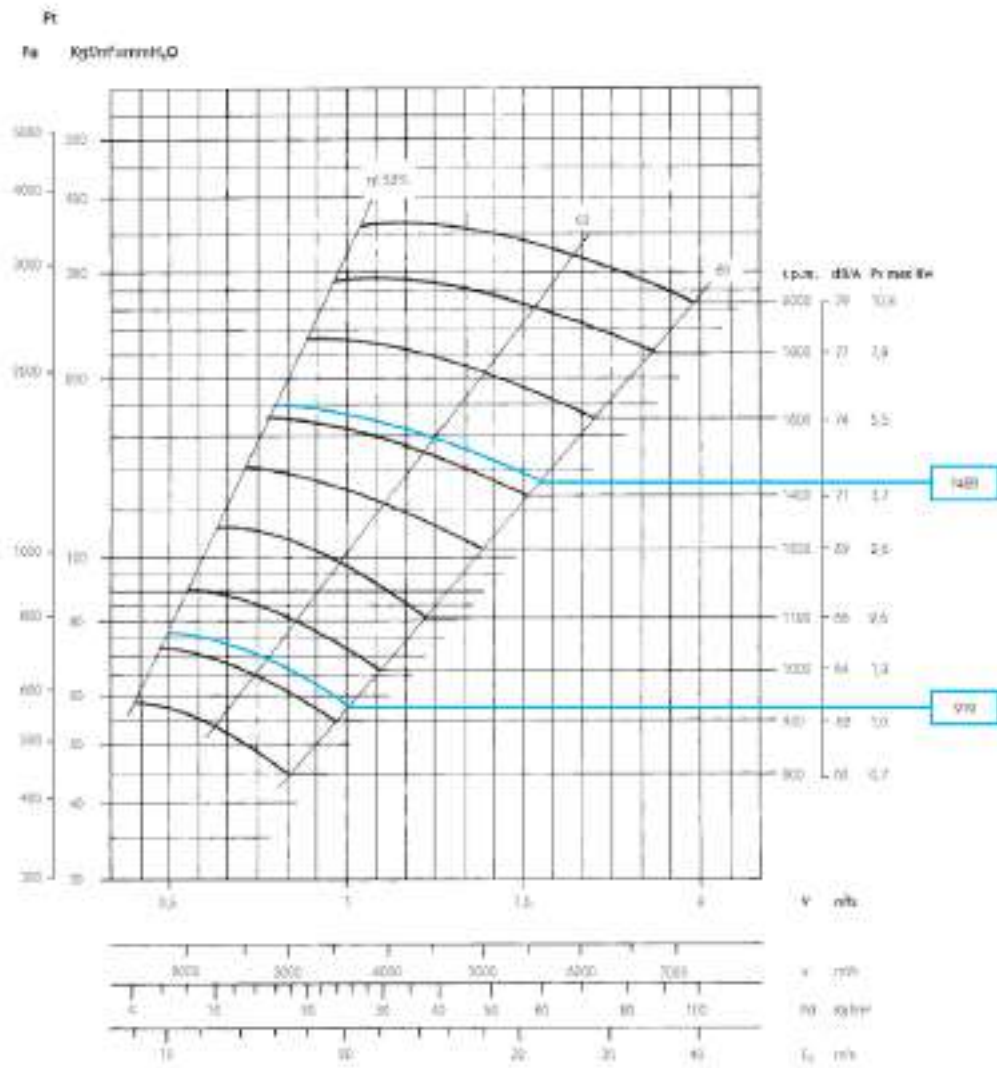

Margen sobre el caudal ± 5 %
 Margen del nivel sonoro +3...5db
 Margen kW absorbidos ± 3%
 Características en impulsión.

Rpm Características para:
 sistema 4 y 5 en motor
 directo con 2/4/6/8 polos
 según modelo.

Curvas Características

CMTC 670

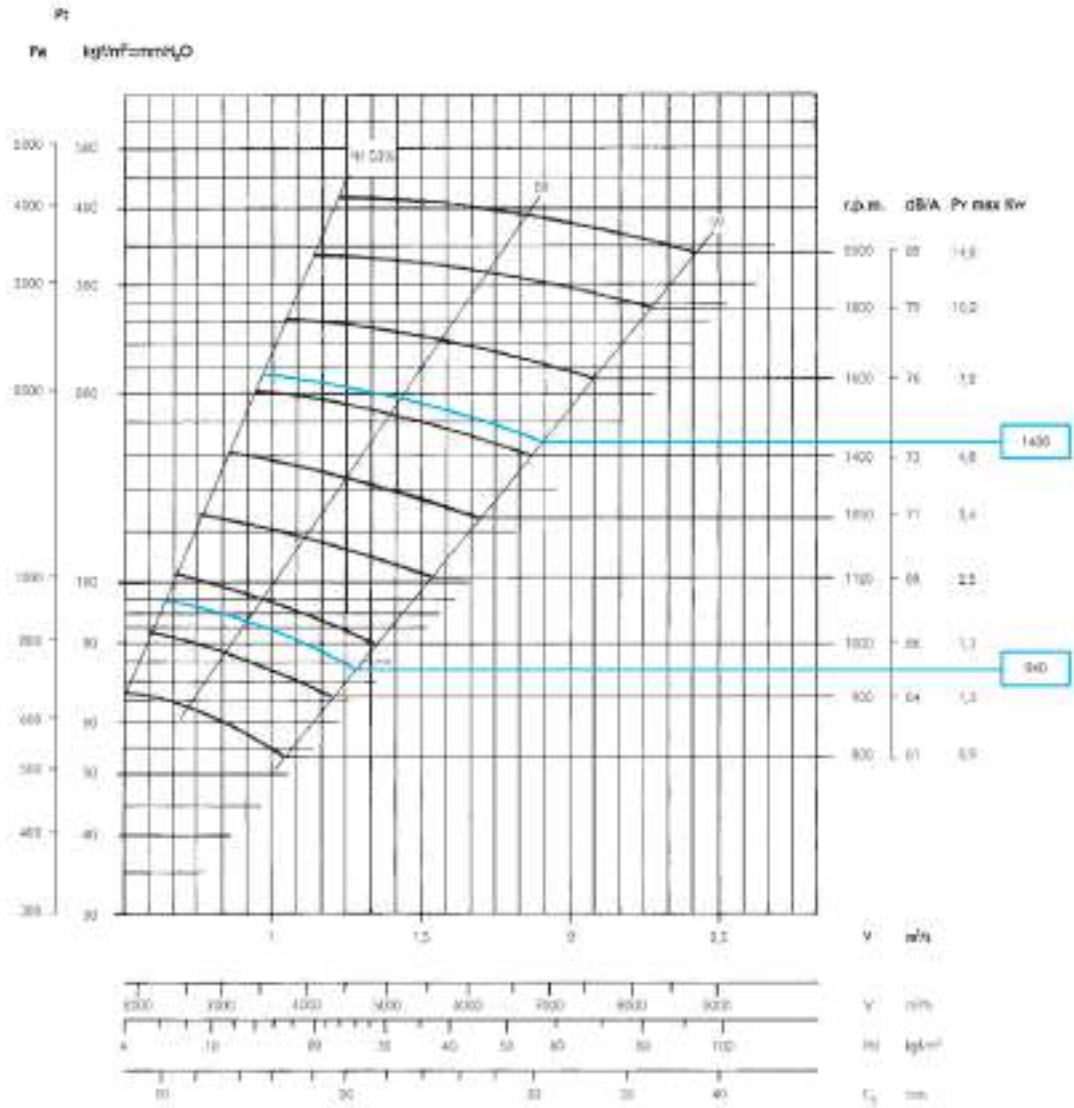

LARGE SERIES

Margen sobre el caudal ± 5 %
 Margen del nivel sonoro +3...5db
 Margen kW absorbidos ± 3%

Características en impulsión.

Rpm

Características para:
 sistema 4 y 5 en motor
 directo con 2/4/6/8 polos
 según modelo.

Curvas Características

CMTC 700

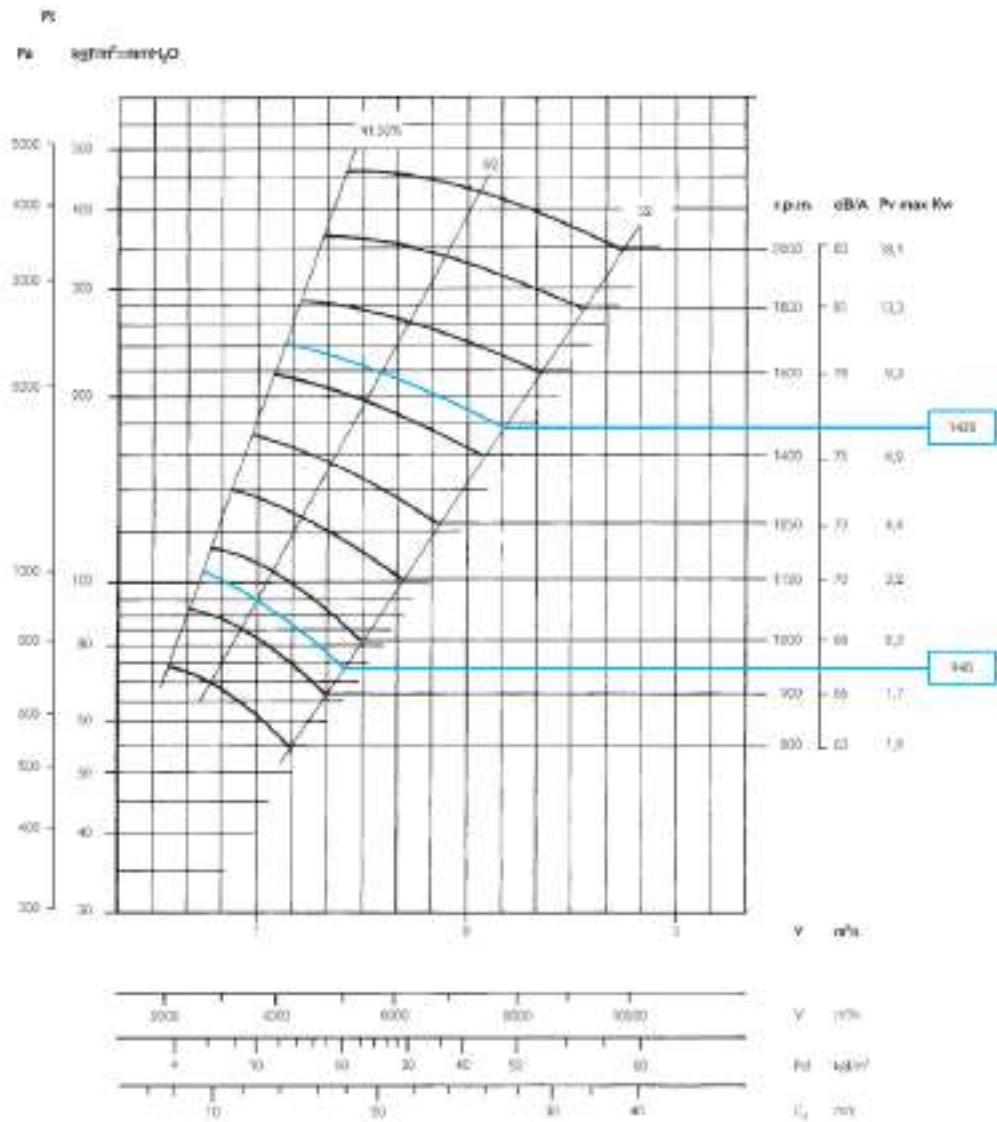

Margen sobre el caudal ± 5 %
 Margen del nivel sonoro +3...5db
 Margen kW absorbidos ± 3%

Características en impulsión.

Rpm

Características para:
 sistema 4 y 5 en motor
 directo con 2/4/6/8 polos
 según modelo.

Curvas Características

CMTC 750

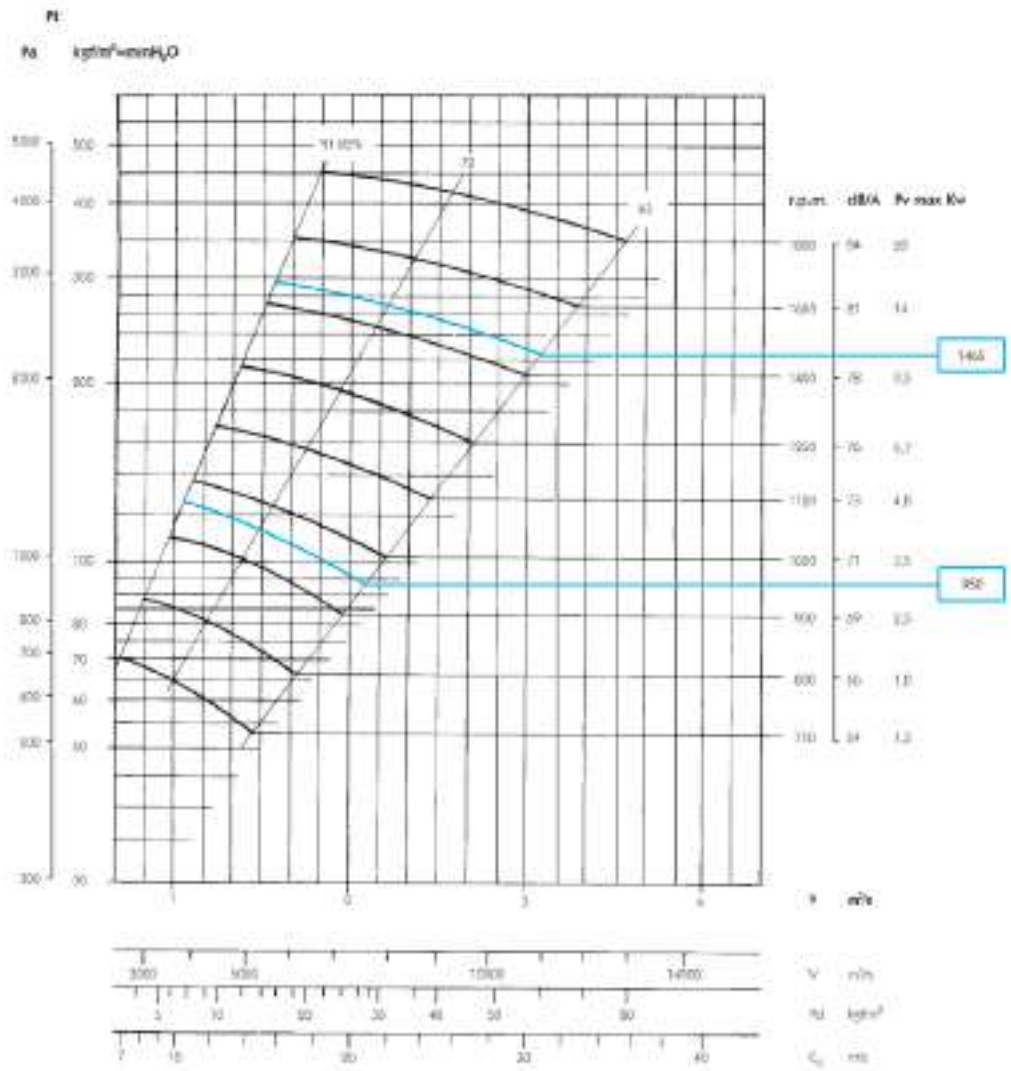

LARGE SERIES

Margen sobre el caudal ± 5 %
 Margen del nivel sonoro +3...5db
 Margen kW absorbidos ± 3%

Características en impulsión.

Rpm Características para:
 sistema 4 y 5 en motor
 directo con 2/4/6/8 polos
 según modelo.

Curvas Características

CMTC 800

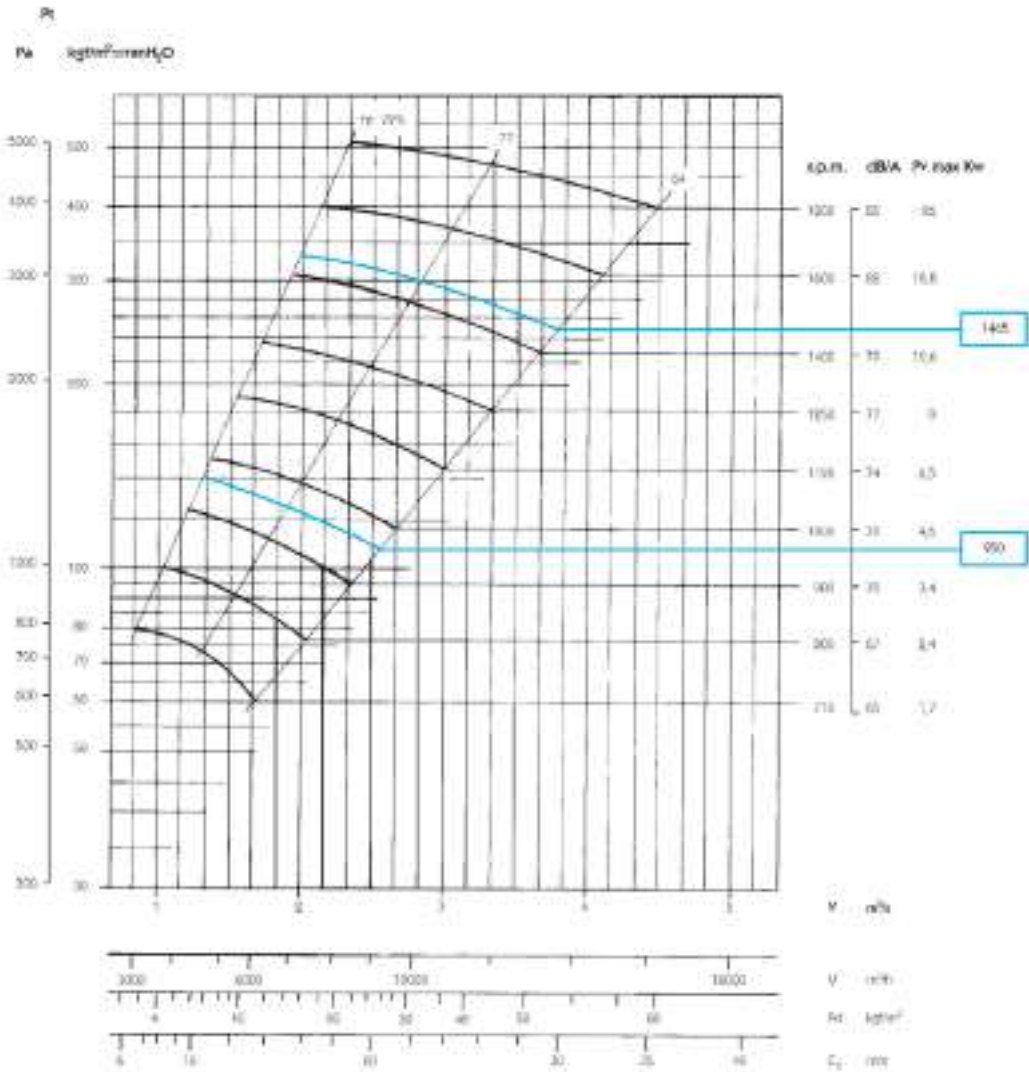

Margen sobre el caudal ± 5 %
 Margen del nivel sonoro +3...5db
 Margen kW absorbidos ± 3%

Características en impulsión.

Rpm

Características para:
 sistema 4 y 5 en motor
 directo con 2/4/6/8 polos
 según modelo.

Curvas Características

CMTC 835

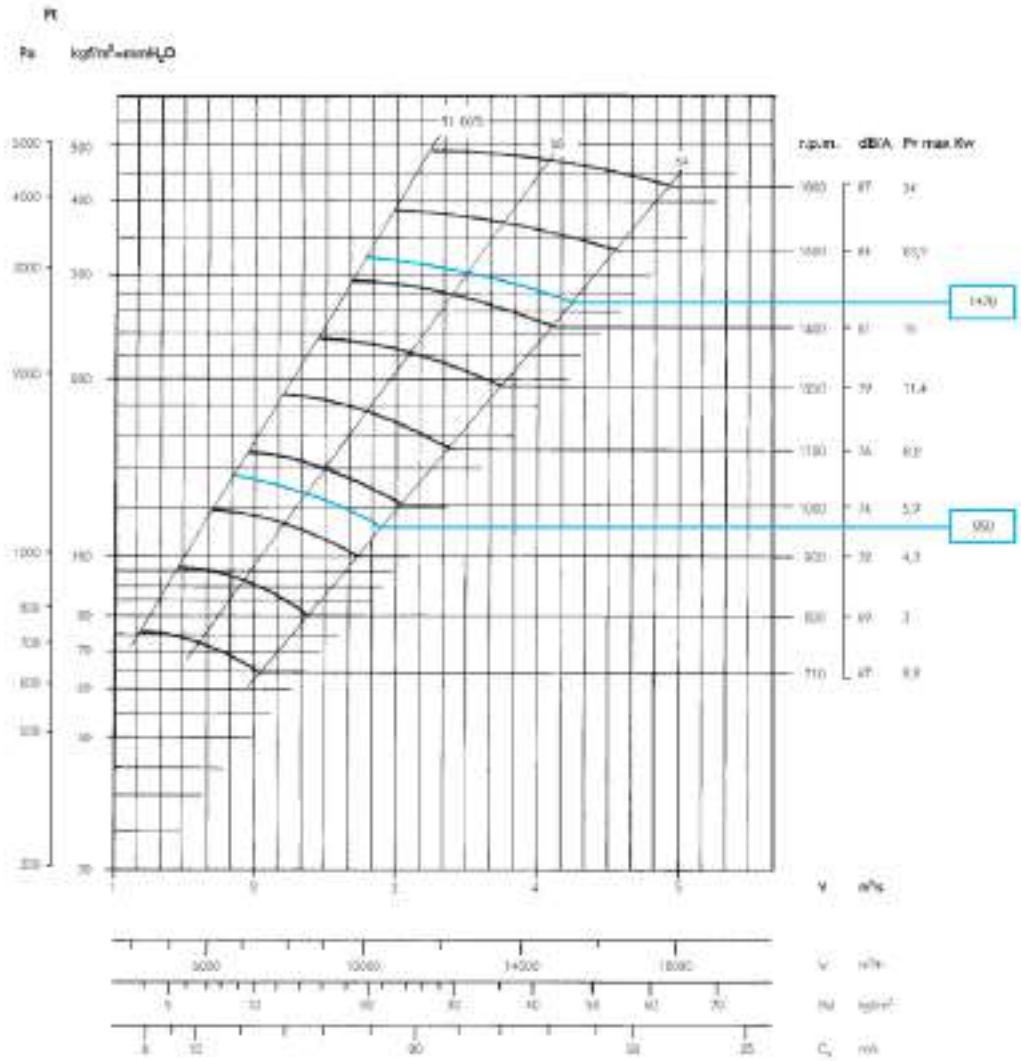

LARGE SERIES

Margen sobre el caudal ± 5 %
 Margen del nivel sonoro +3...5db
 Margen kW absorbidos ± 3%

Características en impulsión.

Rpm Características para:
 sistema 4 y 5 en motor
 directo con 2/4/6/8 polos
 según modelo.

Curvas Características

CMTC 855

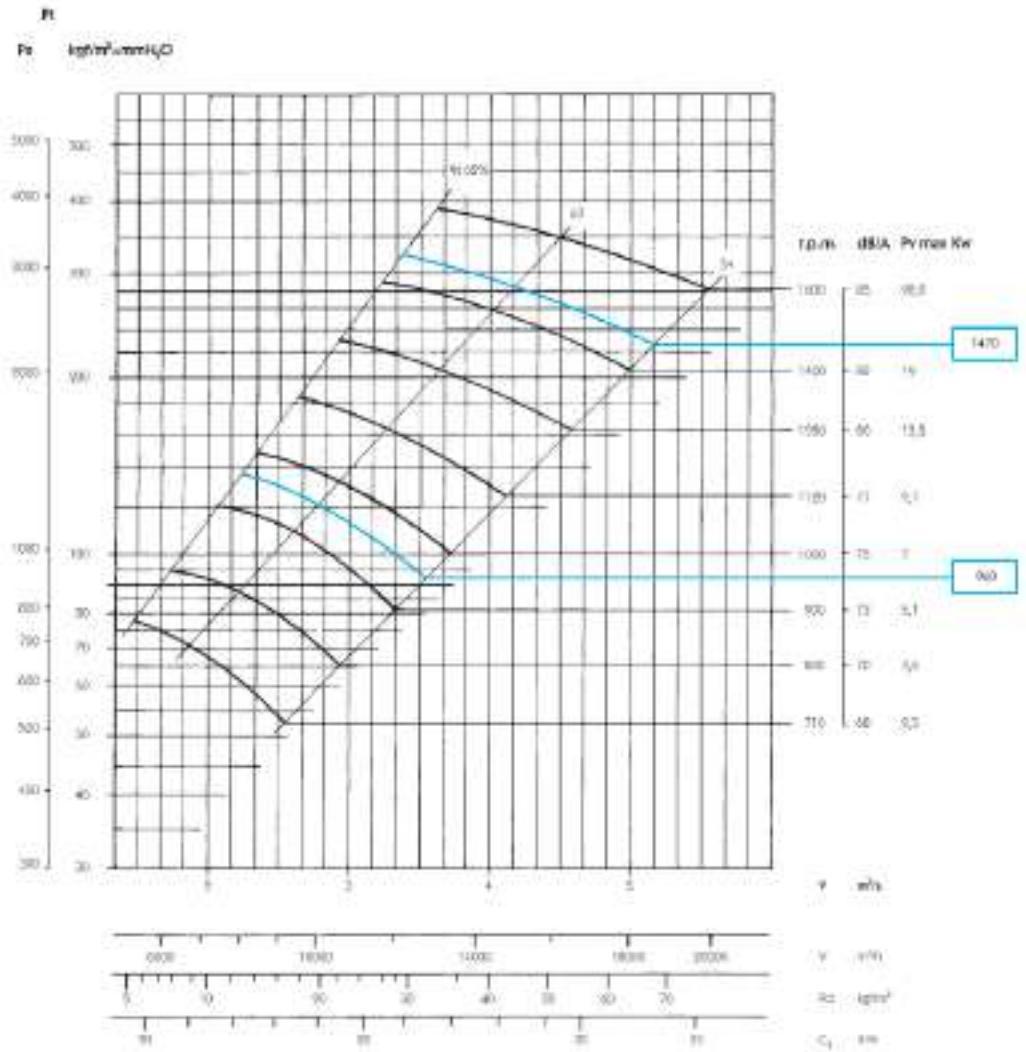

Margen sobre el caudal ± 5 %
 Margen del nivel sonoro +3...5db
 Margen kW absorbidos ± 3%

Características en impulsión.

Rpm

Características para:
 sistema 4 y 5 en motor
 directo con 2/4/6/8 polos
 según modelo.

Dimensiones mm

CMTC 630...855

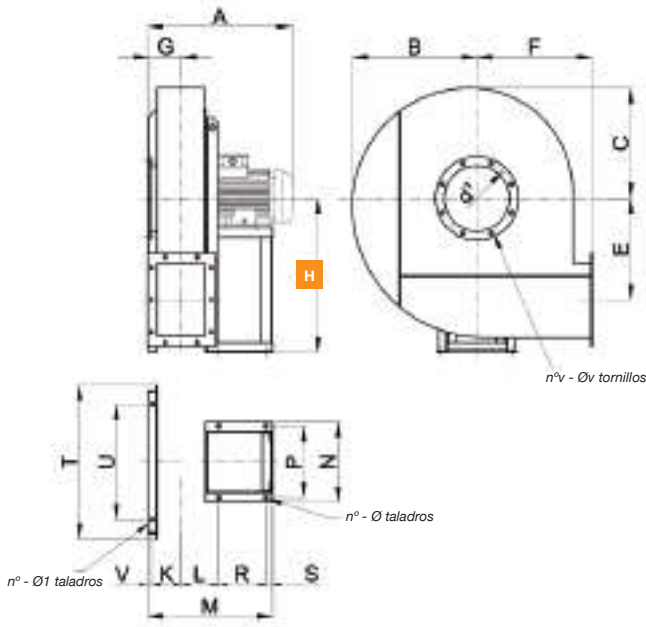

BOCA DE IMPULSIÓN

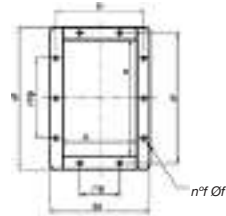

ORIENTACIONES

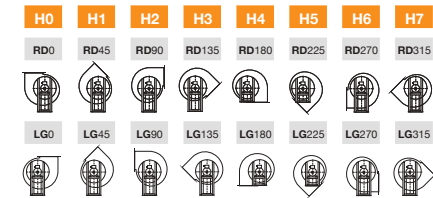

H * La medida de la cota H (distancia entre el suelo y el eje) varía según las orientaciones

MOD.	FRAME	A*	B	C	E	F	G	HO-1-2-3	H4-5	H6-7	L	K	M*	N	P	R*	S	T	U
CMTC 630	112 M/4	540	490	435	395	450	125	600	450	600	146	-	260	312	280	185	25	-	-
CMTC 630	90 L/6	510	490	435	395	450	125	600	450	600	146	-	215	269	245	140	25	-	-
CMTC 670	132 S/4	650	535	480	425	475	145	630	475	630	157	-	320	342	310	245	25	-	-
CMTC 670	112 M/6	560	535	480	425	475	145	630	475	630	157	-	260	312	280	185	25	-	-
CMTC 700	132 MA/4	705	575	515	445	500	160	710	500	710	169	-	320	342	310	245	25	-	-
CMTC 700	112 M/6	590	575	515	445	500	160	710	500	710	169	-	260	312	280	185	25	-	-
CMTC 750	160 M/4	775	640	575	494	560	172	750	560	750	183	-	425	440	400	345	30	-	-
CMTC 750	132 MA/6	730	640	575	494	560	172	750	560	750	183	-	320	342	310	245	25	-	-
CMTC 800	160 L/4	915	655	580	500	560	195	800	560	800	198	183	776	440	400	345	30	820	660
CMTC 800	132 MB/6	790	655	580	500	560	195	800	560	800	198	183	671	342	310	245	25	820	660
CMTC 835	180 M/4	990	730	640	560	630	210	900	630	900	235	201	856	490	450	370	30	900	740
CMTC 835	132 MB/6	830	730	640	560	630	210	900	630	900	215	201	706	342	310	245	25	900	740
CMTC 855	180 L/4	990	730	640	560	630	210	900	630	900	235	201	856	490	450	370	30	900	740
CMTC 855	160 M/6	870	730	640	560	630	210	900	630	900	215	201	811	490	450	345	30	900	740

BOCA IMPULSIÓN

MOD.	V	n°	Φ	Φ ¹	d ¹	n°v	Φv	a	b	a ¹	b ¹	a ²	b ²	n°p	n°p	n°f	Φf	kg	WD ²
CMTC 630	-	4	12	-	292	8	11	284	185	332	232	364	265	1-125	2-125	10	12	135	4,1
CMTC 630	-	4	10	-	292	8	11	284	185	332	232	364	265	1-125	2-125	10	12	105	4,1
CMTC 670	-	4	12	-	332	8	11	320	207	366	251	400	287	1-125	2-125	10	12	170	5,3
CMTC 670	-	4	12	-	332	8	11	320	207	366	251	400	287	1-125	2-125	10	12	150	5,3
CMTC 700	-	4	12	-	366	8	11	360	231	405	274	440	311	1-125	2-125	10	12	185	6,1
CMTC 700	-	4	12	-	366	8	11	360	231	405	274	440	311	1-125	2-125	10	12	155	6,1
CMTC 750	-	4	14	-	405	8	11	405	257	448	298	485	337	1-125	3-125	12	12	270	8,9
CMTC 750	-	4	12	-	405	8	11	405	257	448	298	485	337	1-125	3-125	12	12	225	8,9
CMTC 800	20	6	14	19	448	12	11	457	287	497	327	537	367	2-125	3-125	14	12	305	12
CMTC 800	20	6	12	19	448	12	11	457	287	497	327	537	367	2-125	3-125	14	12	255	12
CMTC 835	20	6	17	19	497	12	11	507	322	551	366	587	402	2-125	3-125	14	12	375	14
CMTC 835	20	6	12	19	497	12	11	507	322	551	366	587	402	2-125	3-125	14	12	290	14
CMTC 855	20	6	17	19	497	12	11	507	322	551	366	587	402	2-125	3-125	14	12	400	15,3
CMTC 855	20	6	14	19	497	12	11	507	322	551	366	587	402	2-125	3-125	14	12	320	15,3

(*) Para construcciones a "ALTA TEMP." cotas "A-M-R" + 50 mm.
(kg) Peso ventilador con motor.
WD² = Momento de inercia del rodete, expresado en Kg x m²

LARGE SERIES

Dimensiones mm

CMTC-X 630...855

SISTEMA
1

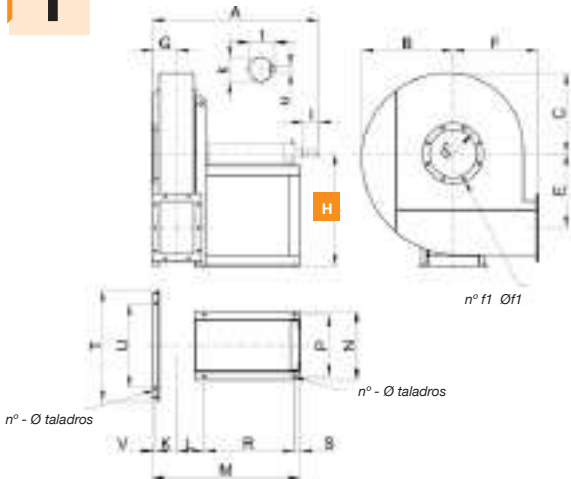

CMTC-X 630...750

SISTEMA
12

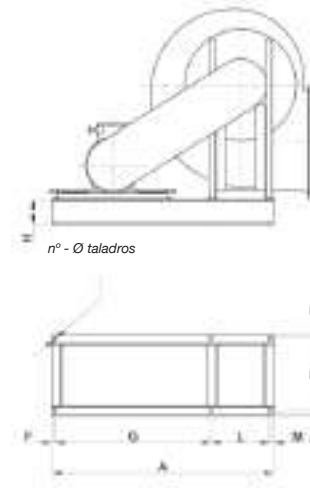

CMTC-X 800...855

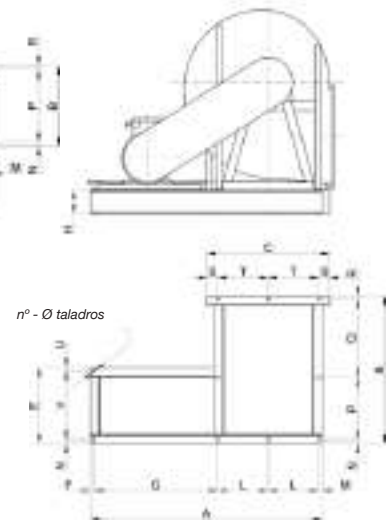

MOD.	A*	B	C	E	F	G	HO-1-2-3	H4-5	H6-7
CMTC 630	890	490	435	395	450	125	600	450	600
CMTC 670	1010	535	480	425	475	145	630	475	630
CMTC 700	1035	575	515	445	500	160	710	500	710
CMTC 750	1060	640	575	494	560	172	750	560	750
CMTC 800	1160	655	580	500	560	195	800	560	800
CMTC 835	1195	730	640	560	630	210	900	630	900
CMTC 855	1195	730	640	560	630	210	900	630	900

MOD.	L	K	M*	N	P	R*	S	T	U	V	n°	Φ	k
CMTC 630	146	-	560	370	330	480	30	-	-	-	4	14	38 k6
CMTC 670	157	-	605	456	395	515	40	-	-	-	4	19	48 k6
CMTC 700	169	-	605	456	395	515	40	-	-	-	4	19	48 k6
CMTC 750	183	-	605	456	395	515	40	-	-	-	4	19	48 k6
CMTC 800	198	183	1006	496	435	565	40	820	660	20	6	19	55 m6
CMTC 835	215	201	1041	496	435	565	40	900	740	20	6	19	55 m6
CMTC 855	215	201	1041	496	435	565	40	900	740	20	6	19	55 m6

MOD.	A	B*	C	E	H	F	G	L	M	N
CMTC 630	1120	540	-	-	160	25	740	330	25	30
CMTC 670	1405	575	-	-	180	30	950	395	30	30
CMTC 700	1405	575	-	-	180	30	950	395	30	30
CMTC 750	1405	575	-	-	180	30	950	395	30	30
CMTC 800	1445	995	820	625	180	30	950	435	30	30
CMTC 835	1665	1035	900	625	180	30	1170	435	30	30
CMTC 855	1665	1035	900	625	180	30	1170	435	30	30

MOD.	l	t	u	d ¹	n°f ¹	Øf1	kg	WD ²
CMTC 630	80	41	10	292	8	11	125	4,1
CMTC 670	110	51,5	14	332	8	11	165	5,3
CMTC 700	110	51,5	14	366	8	11	170	6,1
CMTC 750	110	51,5	14	405	8	11	215	8,9
CMTC 800	110	59	16	448	12	11	245	12
CMTC 835	110	59	16	497	12	11	285	14
CMTC 855	110	59	16	497	12	11	290	15,3

MOD.	P*	Q	R	S	T	U	V	n°	Φ	Kg
CMTC 630	480	-	30	-	-	-	-	6	14	75
CMTC 670	515	-	30	-	-	-	-	6	19	105
CMTC 700	515	-	30	-	-	-	-	6	19	105
CMTC 750	515	-	30	-	-	-	-	6	19	105
CMTC 800	565	381	19	80	660	30	565	8	19	145
CMTC 835	565	416	24	80	740	30	565	8	19	155
CMTC 855	565	416	24	80	740	30	565	8	19	155

(*) Para construcciones a "ALTA TEMP." cotas "A-M-R" +50 mm.
(kg) Peso ventilador sin motor.
WD² = Momento de inercia del rodete, expresado en Kg x m²

(*) Para construcciones a "ALTA TEMP." cotas "B-P" +50 mm.
Kg = Peso de la base soporte

BOCA DE IMPULSIÓN

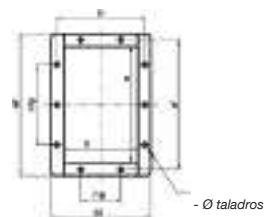

BOCA IMPULSIÓN

MOD.	a	b	a'	b'	a''	b''	n°p	n°p'	n°f	Φf
CMTC 630	284	185	332	232	364	265	1-125	2-125	10	12
CMTC 670	320	207	366	251	400	287	1-125	2-125	10	12
CMTC 700	360	231	405	274	440	311	1-125	2-125	10	12
CMTC 750	405	257	448	298	485	337	1-125	3-125	12	12
CMTC 800	457	287	497	327	537	367	2-125	3-125	14	12
CMTC 835	507	322	551	366	587	402	2-125	3-125	14	12
CMTC 855	507	322	551	366	587	402	2-125	3-125	14	12

ORIENTACIONES

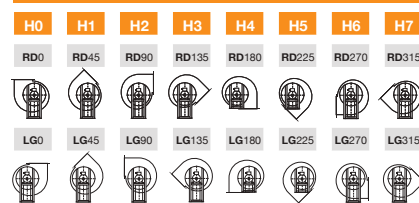

H * La medida de la cota H (distancia entre el suelo y el eje) varía según las orientaciones

LARGE SERIES

Accesorios

Contrabrida aspiración

n° - Ø taladros

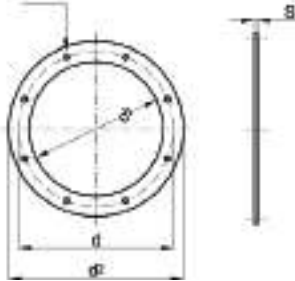

MOD.	d	d'	d ²	n°	Φ	s	kg
CMTC 630	292	255	325	8	11	4	1
CMTC 670	332	286	366	8	11	5	1,6
CMTC 700	366	321	401	8	11	5	1,8
CMTC 750	405	361	441	8	11	5	2
CMTC 800	448	406	486	12	11	5	2,2
CMTC 835	497	456	536	12	11	5	2,5
CMTC 855	497	456	536	12	11	5	2,5

Contrabrida impulsión

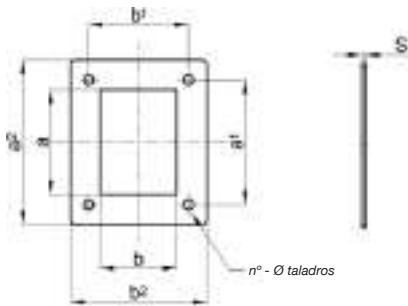

MOD.	a	b	a'	b'	a ²	b ²	n°p	n ² p	n°	Φ	s	kg
CMTC 630	284	185	332	232	364	265	1-125	2-125	10	12	5	1,7
CMTC 670	320	207	366	251	400	287	1-125	2-125	10	12	5	1,8
CMTC 700	360	231	405	274	440	311	1-125	2-125	10	12	5	2
CMTC 750	405	257	448	298	485	337	1-125	3-125	12	12	5	2,2
CMTC 800	457	287	497	327	537	367	2,125	3,125	14	12	5	2,5
CMTC 835	507	322	551	366	587	402	2-125	3-125	14	12	5	2,8
CMTC 855	507	322	551	366	587	402	2,125	3,125	14	12	5	2,8

Red protección en aspiración

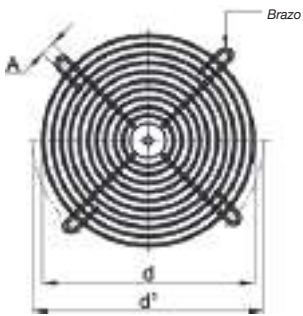

MOD.	d	d'	A	n°	kg
CMTC 630	255	292	11	4	0,3
CMTC 670	286	332	11	4	0,35
CMTC 700	321	366	11	4	0,4
CMTC 750	361	405	11	8	0,7
CMTC 800	406	448	11	8	0,8
CMTC 835	456	497	11	8	0,9
CMTC 855	456	497	11	8	0,9

Junta anti vibratoria en aspiración

n° - Ø taladros

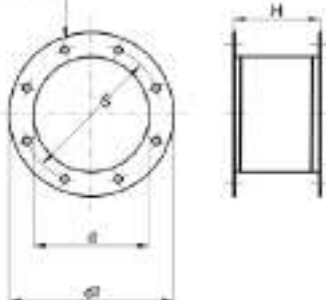

MOD.	d	d'	d ²	n°	Φ	H	kg
CMTC 630	292	255	325	8	11	200	2,2
CMTC 670	332	286	366	8	11	200	3,4
CMTC 700	366	321	401	8	11	200	3,8
CMTC 750	405	361	441	8	11	200	4,2
CMTC 800	448	406	486	12	11	200	4,6
CMTC 835	497	456	536	12	11	200	5,2
CMTC 855	497	456	536	12	11	200	5,2

LARGE SERIES

Accesorios

Junta anti vibratoria en impulsión

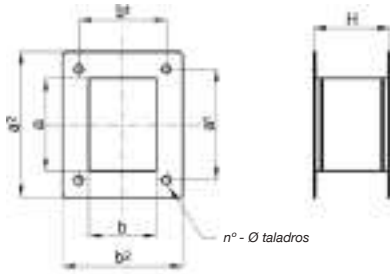

MOD.	a	b	a'	b'	a''	b''	n°p	n²p	n°	Φ	H	kg
CMTC 630	284	185	332	232	364	265	1-125	2-125	10	12	200	3,7
CMTC 670	320	207	366	251	400	287	1-125	2-125	10	12	200	3,9
CMTC 700	360	231	405	274	440	311	1-125	2-125	10	12	200	4,3
CMTC 750	405	257	448	298	485	337	1-125	3-125	12	12	200	4,7
CMTC 800	457	287	497	327	537	367	2-125	3-125	14	12	200	5,3
CMTC 835	507	322	551	366	587	402	2-125	3-125	14	12	200	5,9
CMTC 855	507	322	551	366	587	402	2-125	3-125	14	12	200	5,9

Amortiguadores

TIPO 1



TIPO 2

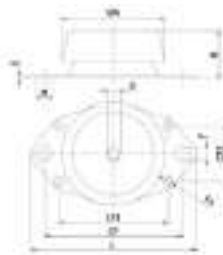

MOD.	MODELO AMORTIGUADORES	TIPO	øA	B	D	CF	CF1	CF2	F	øF1	L	M	S
CMTC 630	CF 623110	1	67	33...34	10	76,5	-	-	9	-	90,5	16	2
CMTC 670	CF 623110	1	67	33...34	10	76,5	-	-	9	-	90,5	16	2
CMTC 700	CF 623110	1	67	33...34	10	76,5	-	-	9	-	90,5	16	2
CMTC 750	CF 924512	2	92	44...45	12	120	98	50	10,5	8,5	130	15,5	2,5
CMTC 800	CF 924512	2	92	44...45	12	120	98	50	10,5	8,5	130	15,5	2,5
CMTC 835	CF 924512	2	92	44...45	12	120	98	50	10,5	8,5	130	15,5	2,5
CMTC 855	CF 924512	2	92	44...45	12	120	98	50	10,5	8,5	130	15,5	2,5

Silenciadores circulares

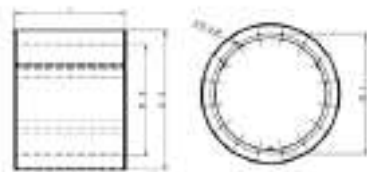

Los silenciadores se utilizan para bajar el nivel sonoro en instalaciones de acondicionamiento o ventilación, fabricados en acero cincado

- Bajo demanda: otras construcciones en diferentes materiales.

øD	øE	L	øI	F	øM	øD	øE	L	øI	F	øM
315	515	ØD,1,5ØD, 2ØD	355	8	M8	900	1100	ØD,1,5ØD, 2ØD	970	16	M10
355	555	ØD,1,5ØD, 2ØD	395	8	M8	1000	1200	ØD,1,5ØD, 2ØD	1070	16	M10
400	600	ØD,1,5ØD, 2ØD	450	8	M8	1120	1320	ØD,1,5ØD, 2ØD	1190	20	M10
450	650	ØD,1,5ØD, 2ØD	500	8	M8	1250	1450	ØD,1,5ØD, 2ØD	1320	20	M10
500	700	ØD,1,5ØD, 2ØD	560	12	M8	1400	1600	ØD,1,5ØD, 2ØD	1470	20	M10
560	760	ØD,1,5ØD, 2ØD	620	12	M8	1500	1700	ØD,1,5ØD, 2ØD	1570	20	M10
630	830	ØD,1,5ØD, 2ØD	690	12	M8	1600	1800	ØD,1,5ØD, 2ØD	1680	24	M14
710	910	ØD,1,5ØD, 2ØD	770	16	M8	1700	1900	ØD,1,5ØD, 2ØD	1780	24	M14
800	1000	ØD,1,5ØD, 2ØD	860	16	M8	1800	2000	ØD,1,5ØD, 2ØD	1880	24	M14

Ventiladores para hornos

VENTILADORES PARA HORNOS DE PANADERÍA Y PASTERERÍA



310

SDECB/M

Ventiladores centrífugos especialmente diseñados para la extracción de aire caliente máx. 80 °C y vapores de agua en campanas de extracción, con salida de aire vertical.

Especialmente diseñados para hornos de panadería y pastelería y hornos de tratamiento de superficies.



312

SDECB/O

Ventiladores centrífugos construidos en INOX especialmente diseñados para la extracción de aire caliente máx. 80 °C y vapores de agua en campanas de extracción, con salida de aire horizontal.

Especialmente diseñados para hornos de panadería y pastelería y hornos de tratamiento de superficies.



313

SDBP/F

Ventiladores centrífugos construidos en INOX especialmente diseñados para la extracción de aire caliente máx. 80 °C y vapores de agua en campanas de extracción, con salida de aire horizontal.

Especialmente diseñados para hornos de panadería y pastelería y hornos de tratamiento de superficies.



314

SDBP/M INOX

Ventiladores centrífugos construidos en INOX especialmente diseñados para la extracción de aire caliente máx. 80 °C y vapores de agua en campanas de extracción, con salida de aire vertical y construcción inoxidable.

Especialmente diseñados para hornos de panadería y pastelería y hornos de tratamiento de superficies.



315

SDECB/MGC

Ventiladores centrífugos especialmente diseñados para la recirculación de aire caliente en hornos máx. 300 °C.

Especialmente diseñados para hornos de panadería y pastelería y hornos de tratamiento de superficies.



316

SDECB/Z

Ventiladores centrífugos especialmente diseñados para la extracción de aire caliente máx 300 °C en campanas de extracción, con salida de aire vertical.

Especialmente diseñados para hornos de panadería y pastelería y hornos de tratamiento de superficies.



318

SDLM/F

Ventiladores centrífugos especialmente diseñados para la extracción de aire caliente en hornos máx. 300 °C y salida de aire horizontal.

Especialmente diseñados para hornos de panadería y pastelería y hornos de tratamiento de superficies.



VENTILADORES PARA HORNOS INDUSTRIALES



320

CMRH

Ventiladores accionados a transmisión, equipados con motor eléctrico, conjunto de poleas, correas y protectores normalizados según norma ISO-13857 y cajón calorifugado con fibra mineral de 150 mm, para trabajo horizontal



325

CMSH

Ventiladores centrífugos de media presión, equipados con turbina a reacción y cajón calorifugado con fibra mineral



329

CMPH

Ventiladores centrífugos de media presión, equipados con turbina a acción y cajón calorifugado con fibra mineral



332

HPX

Ventiladores helicoidales tubulares, con motor exterior



335

HBA

Ventiladores helicoidales tubulares bifurcados, con motor fuera del flujo de aire

SDECB/M

Ventiladores centrífugos especialmente diseñados para la extracción de aire caliente máx. 80 °C y vapores de agua en campanas de extracción, con salida de aire vertical
Especialmente diseñados para hornos de panadería y pastelería y hornos de tratamiento de superficies



Ventilador:

- Envoltente en chapa de acero.
- Turbina a acción en chapa de acero galvanizado.
- Motor directamente acoplado con brida B-5.

Motor:

- Motores con eficiencia IE3 para potencias iguales o superiores a 0,75 kW, excepto monofásicos, 2 velocidades y 8 polos.
- Protección IP55.
- Trifásicos 230/400 V 50 Hz (hasta 4 kW) y 400/690 V 50 Hz (potencias superiores a 4 kW).
- Temperatura máxima del aire a transportar: -25 °C +80 °C.

Acabado:

- Anticorrosivo con pintura anticálórica resistente a la temperatura, color aluminio.

Bajo demanda:

- Bobinados especiales para diferentes tensiones.
- Ventilador en acero inoxidable.



Bajo demanda: Ventilador en acero inoxidable

Características

MOD.	kW	r.p.m	dB/A	CAPACIDAD (m³/s)												
				0,017	0,03	0,06	0,07	0,08	0,1	0,12	0,13	0,16	0,17	0,18	0,2	0,23
				PRESIÓN TOTAL (mmH ₂ O)												
SDECB/M-160-2T-0.5	0,37	2800	60					35	36	37	38	39	40	40	37	35
SDECB/M-160-4T-0.33	0,25	1350	49	9	9	10	10	9	8	7						
SDECB/M-230-4T-0.33	0,25	1350	58					28	29	29	30	31	30	29	28	27
SDECB/M-230-6T-0.33	0,25	890	49					14	15	15	15	16	15	15	14	13

MOD.	kW	r.p.m	dB/A	CAPACIDAD (m³/s)												
				0,18	0,2	0,23	0,27	0,3	0,33	0,38	0,42	0,47	0,53	0,58	0,67	
				PRESIÓN TOTAL (mmH ₂ O)												
SDECB/M-250-4T-0.5	0,37	1350	60			40	42	43	44	45	45	40	35			
SDECB/M-300-4T-0.5	0,37	1350	65					47	49	50	50	51	50	48	43	
SDECB/M-300-6T-0.33	0,25	890	49	20	20	22	23	24	24	23	22					

Margen sobre el caudal ±5%
 Margen del nivel sonoro +3...5 db

Dimensiones mm

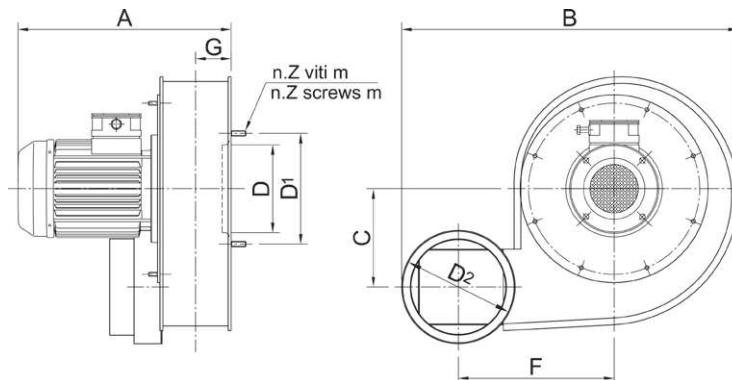

MOD.	FRAME	kW	r.p.m	A	B	C	F	G	D	D1	m	n.Z	D2	Kg
SDECB/M-160-2T-0.5	71A2	0,37	2800	330	400	120	173	59	128	220	M5	6	137	10
SDECB/M-160-4T-0.33	71A4	0,25	1350	330	400	120	173	59	128	220	M5	6	137	10
SDECB/M-230	71A4	0,25	1350	295	500	150	227	53	130	165	M8	6	160	15
SDECB/M-250-4T-0.5	71B4	0,37	1350	400	540	170	238	60	145	195	M8	6	176	18
SDECB/M-300-4T-0.5	71B4	0,37	1350	435	665	200	285	82	192	250	M8	6	250	20
SDECB/M-300-6T-0.33	71B6	0,25	890	435	665	200	285	82	192	250	M8	6	250	20

Curvas Características

SDECB/M 160

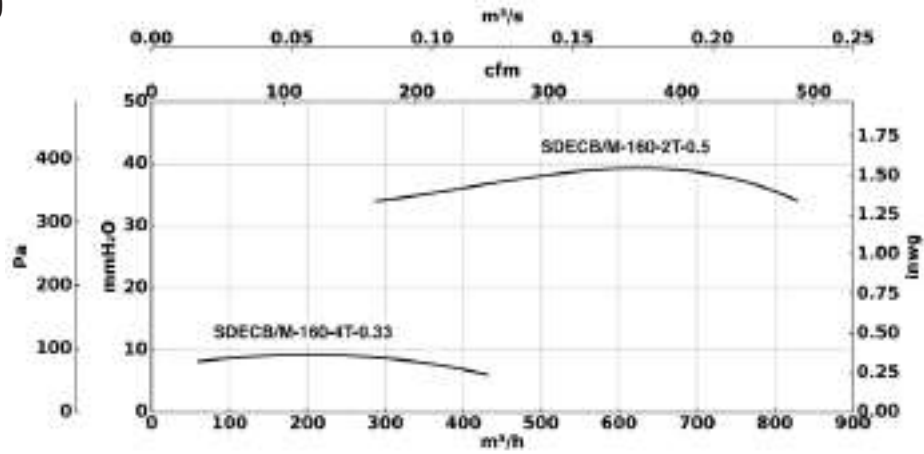

SDECB/M 230...250

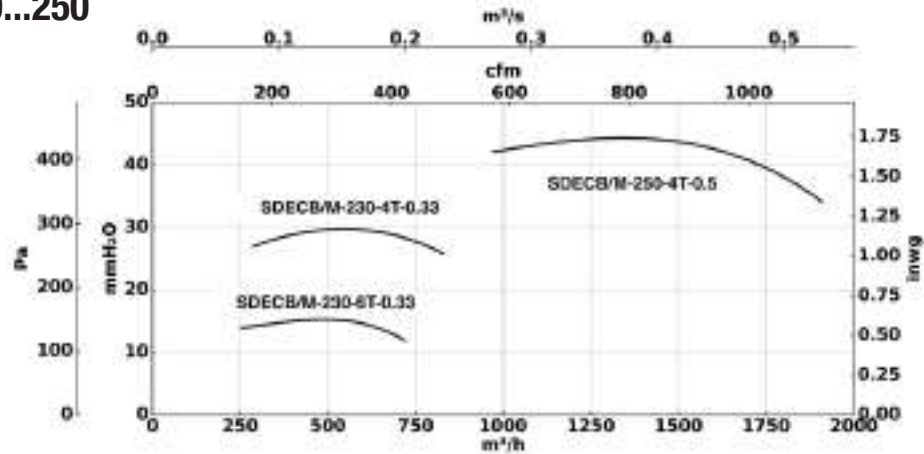

SDECB/M 300

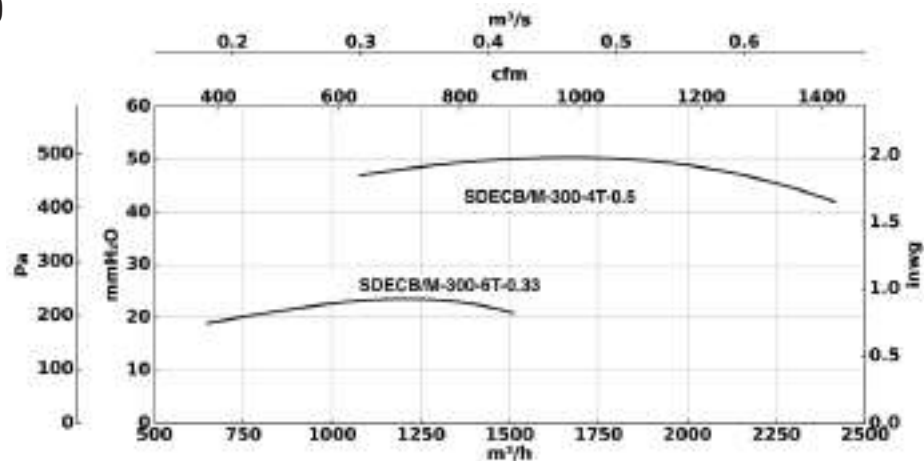

Presión total

Margen sobre el caudal $\pm 5\%$
 Margen del nivel sonoro $+3...5$ db
 Margen kW absorbidos $\pm 3\%$

SDECB/O

Ventiladores centrifugos construidos en INOX especialmente diseñados para la extracción de aire caliente máx. 80 °C y vapores de agua en campanas de extracción, con salida de aire horizontal
Especialmente diseñados para hornos de panadería y pastelería y hornos de tratamiento de superficies



- Ventilador:**
- Envoltente en chapa de acero.
 - Turbina a acción en chapa de acero.
 - Motor directamente acoplado con brida B-5.

- Motor:**
- Motores con eficiencia IE3 para potencias iguales o superiores a 0,75 kW, excepto monofásicos, 2 velocidades y 8 polos.
 - Protección IP55.
 - Trifásicos 230/400 V 50 Hz (hasta 4 kW) y 400/690 V 50 Hz (potencias superiores a 4 kW).
 - Temperatura máxima del aire a transportar: -25 °C +80 °C.

- Acabado:**
- Anticorrosivo con pintura anticorrosiva resistente a la temperatura, color aluminio.

- Bajo demanda:**
- Bobinados especiales para diferentes tensiones.
 - Ventilador en acero inoxidable AISI-304.



Bajo demanda: brida soporte ventilador

Características

MOD.	kW	r.p.m	dB/A	CAPACIDAD (m ³ /s)										
				0,23	0,27	0,3	0,33	0,38	0,42	0,47	0,53	0,58	0,67	
SDECB/O-250-4T-0.5	0,37	1350	60	40	42	43	44	45	45	40	35			
SDECB/O-300-4T-0.5	0,37	1350	65			47	49	50	50	51	50	48	43	

Margen sobre el caudal ±5%
 Margen del nivel sonoro +3...5 db

Dimensiones mm

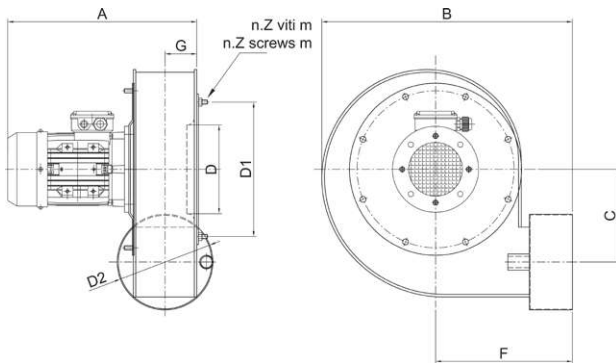

MOD.	kW	r.p.m	A	B	C	F	G
SDECB/O-250-4T-0.5	0,37	1350	352	466	173	255	60
SDECB/O-300-4T-0.5	0,37	1350	402	575	202	322	83

MOD.	D	D1	m	n.Z	D2	Kg
SDECB/O-250-4T-0.5	165	250	M8	6	178	16
SDECB/O-300-4T-0.5	190	250	M8	6	241	18

Curvas Características

SDECB/O 250...300

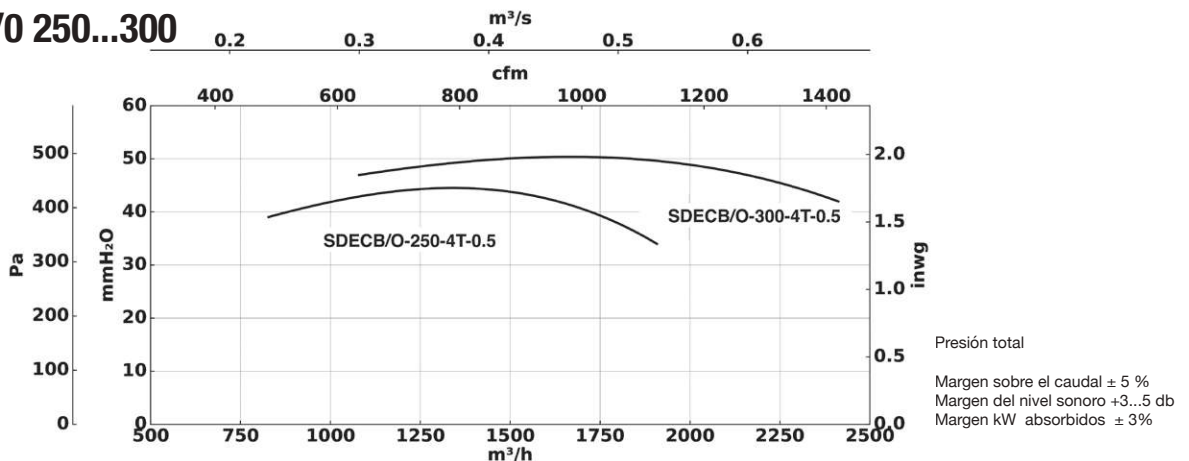

SDBP/F

Ventiladores centrífugos contruidos en INOX especialmente diseñados para la extracción de aire caliente máx. 80 °C y vapores de agua en campanas de extracción, con salida de aire horizontal

Especialmente diseñados para hornos de panadería y pastelería y hornos de tratamiento de superficies



Ventilador:

- Envoltente en chapa de acero inoxidable.
- Turbina a acción en chapa de acero inoxidable.
- Motor directamente acoplado con brida B-5.

Acabado:

- Anticorrosivo en chapa de acero inoxidable.

Bajo demanda:

- Bobinados especiales para diferentes tensiones.
- Ventilador en acero pintado.

Motor:

- Motores con eficiencia IE3 para potencias iguales o superiores a 0,75 kW, excepto monofásicos, 2 velocidades y 8 polos.
- Protección IP55.
- Trifásicos 230/400 V 50 Hz (hasta 4 kW) y 400/690 V 50 Hz (potencias superiores a 4 kW).
- Temperatura máxima del aire a transportar: -25 °C +80 °C.



Bajo demanda: brida soporte ventilador

Características

MOD.	kW	r.p.m	dB/A	CAPACIDAD (m ³ /s)										
				0,008	0,017	0,03	0,06	0,07	0,08	0,1	0,12	0,13	0,16	0,17
PRESIÓN TOTAL (mm H ₂ O)														
SDBP/F-100-2T-0.25	0,18	2680	58			30	32	33	34	35	36	36	30	24
SDBP/F-100-4T-0.25	0,18	1340	48	6	6	7	7	8	7					

Margen sobre el caudal ±5%
Margen del nivel sonoro +3...5 db

Dimensiones mm

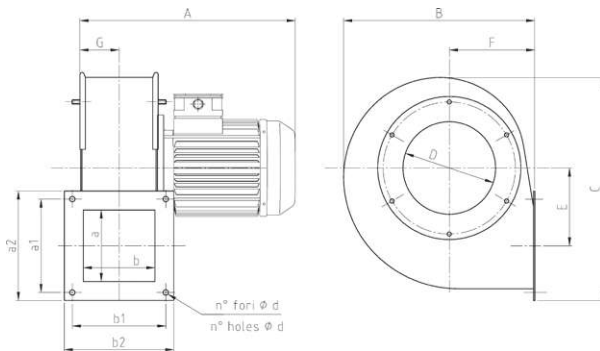

MOD.	kW	r.p.m	A	B	C	E	F
SDBP/F-100-2T-0.25	0,18	2680	260	220	251	92	102
SDBP/F-100-4T-0.25	0,18	1340	260	220	251	92	102

MOD.	G	D	a x b	a1	b1	a2	b2
SDBP/F-100-2T-0.25	48	155	86 X 86	110	110	130	130
SDBP/F-100-4T-0.25	48	155	86 X 86	110	110	130	130

MOD.	n°	d	Kg
SDBP/F-100-2T-0.25	4	7	6,45
SDBP/F-100-4T-0.25	4	7	6,45

Curvas Características

SDBP/F 100

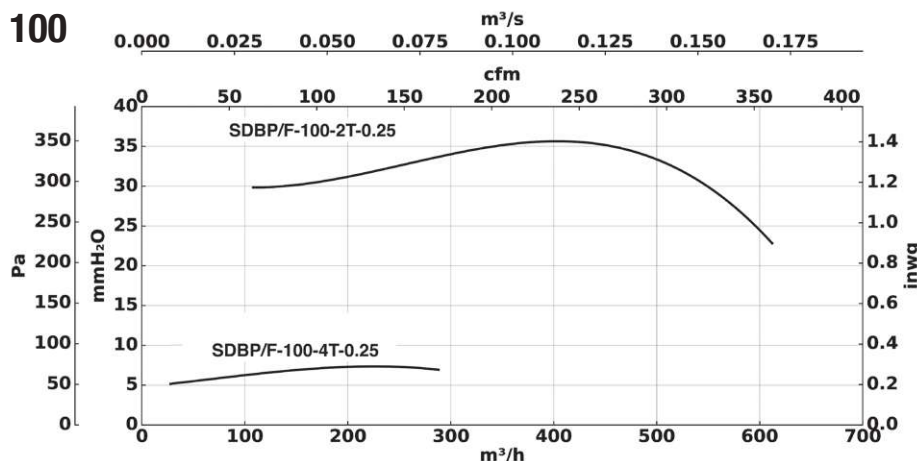

Presión total

Margen sobre el caudal ± 5 %
Margen del nivel sonoro +3...5 db
Margen kW absorbidos ± 3%

SDBP/M INOX

Ventiladores centrifugos contruidos en INOX especialmente diseñados para la extracción de aire caliente máx. 80 °C y vapores de agua en campanas de extracción, con salida de aire vertical y construcción Inoxidable

Especialmente diseñados para hornos de panadería y pastelería y hornos de tratamiento de superficies



Ventilador:

- Envoltente en chapa de acero inoxidable.
- Turbina a acción en chapa de acero inoxidable.
- Motor directamente acoplado con brida B-5.

Motor:

- Motores con eficiencia IE3 para potencias iguales o superiores a 0,75 kW, excepto monofásicos, 2 velocidades y 8 polos.
- Protección IP55.
- Trifásicos 230/400 V 50 Hz (hasta 4 kW) y 400/690 V 50 Hz (potencias superiores a 4 kW).

- Temperatura máxima del aire a transportar: -25 °C +80 °C.

Acabado:

- Anticorrosivo en chapa de acero inoxidable.

Bajo demanda:

- Bobinados especiales para diferentes tensiones.
- Ventilador en acero pintado.

Características

MOD.	kW	r.p.m	dB/A	CAPACIDAD (m³/s)										
				0,008	0,017	0,03	0,06	0,07	0,08	0,1	0,12	0,13	0,16	0,17
PRESIÓN TOTAL (mm H ₂ O)														
SDBP/M INOX-100-2T-0.25	0,18	2680	58			30	32	33	34	35	36	36	30	24
SDBP/M INOX-100-4T-0.25	0,18	1340	48	6	6	7	7	8	7					

Margen sobre el caudal +5%
Margen del nivel sonoro +3...5 db

Dimensiones mm

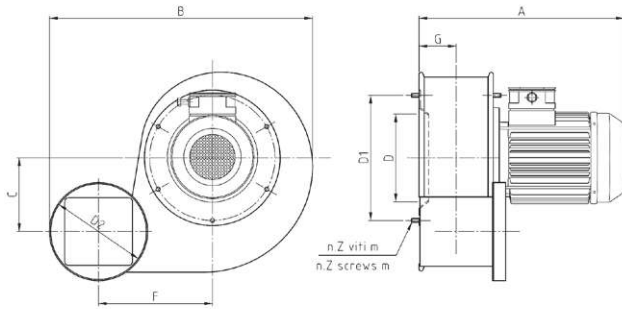

MOD.	kW	r.p.m	A	B	C	F	G
SDBP/M INOX-100-2T-0.25	0,18	2680	255	330	96	142	48
SDBP/M INOX-100-4T-0.25	0,18	1340	255	330	96	142	48

MOD.	D	D1	m	n.Z	D2	Kg
SDBP/M INOX-100-2T-0.25	110	160	M5	6	120	6,75
SDBP/M INOX-100-4T-0.25	110	160	M5	6	120	6,75

Curvas Características

SDBP/M 100

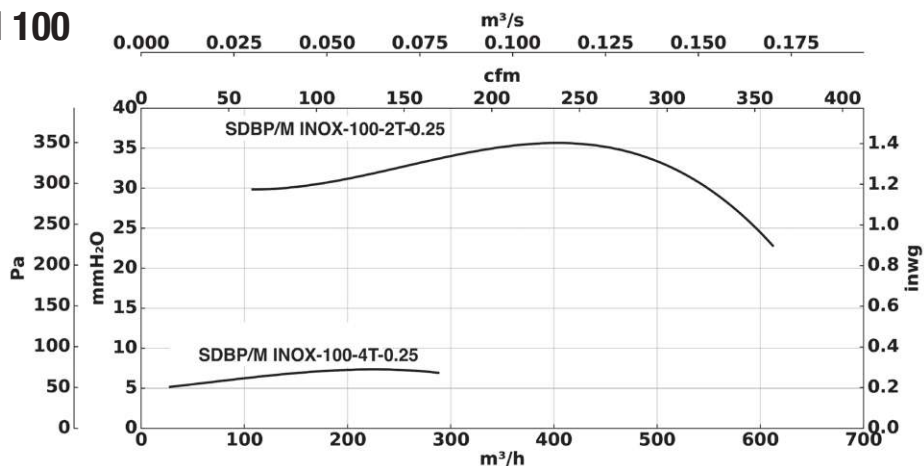

Presión total

Margen sobre el caudal ± 5 %
Margen del nivel sonoro +3...5 db
Margen kW absorbidos ± 3%

SDECB/MGC

Ventiladores centrífugos especialmente diseñados para la recirculación de aire caliente en hornos máx. 300 °C

Especialmente diseñados para hornos de panadería y pastelería y hornos de tratamiento de superficies



Ventilador:

- Envoltorio en chapa de acero.
- Turbina a acción en chapa de acero galvanizado.
- Motor directamente acoplado con brida B-5.
- Con uno o dos rodetes de refrigeración montados sobre el eje del motor para disipar la temperatura.

Motor:

- Motores con eficiencia IE3 para potencias iguales o superiores a 0,75 kW, excepto monofásicos, 2 velocidades y 8 polos.
- Protección IP55.
- Trifásicos 230/400 V 50 Hz (hasta 4 kW) y 400/690 V 50 Hz (potencias superiores a 4 kW).

- Temperatura máxima del aire a transportar: -25 °C +300 °C.

Acabado:

- Anticorrosivo con pintura anticorrosiva resistente a la temperatura, color aluminio.

Bajo demanda:

- Bobinados especiales para diferentes tensiones.
- Ventilador en acero inoxidable.

Características

MOD.	kW	r.p.m	dB/A	CAPACIDAD (m³/s)							
				0,3	0,33	0,38	0,42	0,47	0,53	0,58	0,67
PRESIÓN TOTAL (mmH ₂ O)											
SDECB/MGC-300-4T-1	0,75	1350	65	47	49	50	50	51	50	48	43

Margen sobre el caudal ±5%
Margen del nivel sonoro +3...5 db

Dimensiones mm

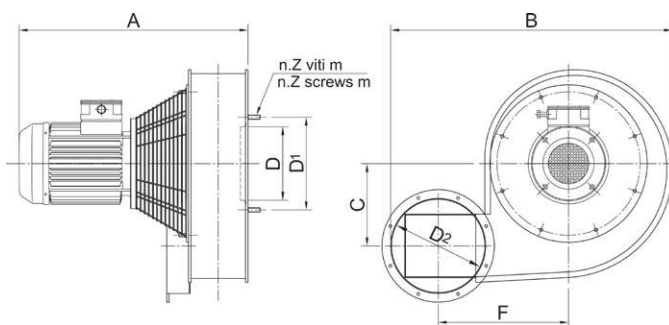

MOD.	kW	r.p.m	A	B	C	F
SDECB/MGC-300-4T-1	0,75	1350	515	665	200	285

MOD.	D	D1	m	n.Z	D2	Kg
SDECB/MGC-300-4T-1	192	250	M8	6	250	35

Curvas Características

SDECB/MGC

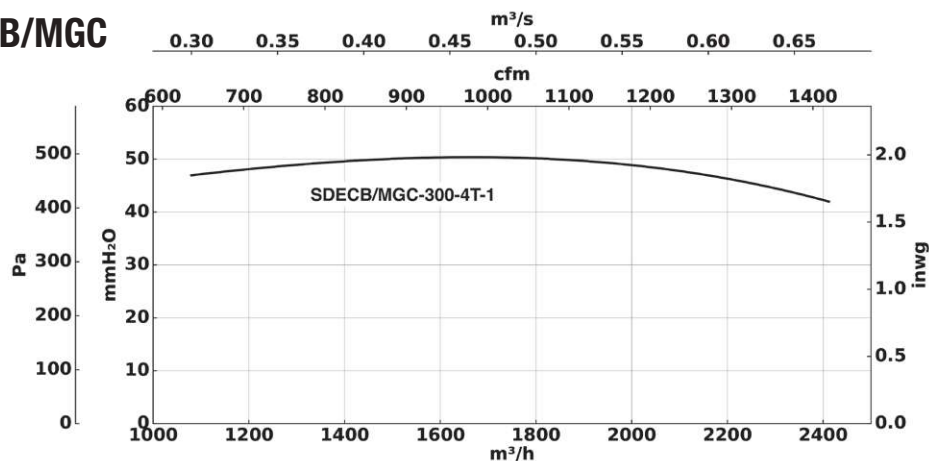

Presión total

Margen sobre el caudal ± 5 %
Margen del nivel sonoro +3...5 db
Margen kW absorbidos ± 3%

SDECB/Z

Ventiladores centrífugos especialmente diseñados para la extracción de aire caliente max 300 °C en campanas de extracción, con salida de aire vertical

Especialmente diseñados para hornos de panadería y pastelería y hornos de tratamiento de superficies



Ventilador:

- Envoltorio en chapa de acero inoxidable.
- Turbina a acción en chapa de acero galvanizado.
- Motor directamente acoplado con brida B-5.
- Con uno o dos rodetes de refrigeración montados sobre el eje del motor para disipar la temperatura.

- Trifásicos 230/400 V 50 Hz (hasta 4 kW) y 400/690 V 50 Hz (potencias superiores a 4 kW).
- Temperatura máxima del aire a transportar: -25 °C +300 °C.

Acabado:

- Anticorrosivo con pintura anticorrosiva resistente a la temperatura, color aluminio.

Motor:

- Motores con eficiencia IE3 para potencias iguales o superiores a 0,75 kW, excepto monofásicos, 2 velocidades y 8 polos.
- Protección IP55.

Bajo demanda:

- Bobinados especiales para diferentes tensiones.
- Ventilador en acero inoxidable.

Características

MOD.	kW	r.p.m	dB	CAPACIDAD (m³/s)															
				0,016	0,03	0,05	0,06	0,08	0,1	0,11	0,13	0,15	0,16	0,18	0,2	0,23	0,26	0,3	0,33
				PRESIÓN TOTAL (mmH ₂ O)															
SDECB/Z-160-2T-0.75	0,55	2810	75	64	62	60	60	61	62	64	66	67	67	68	68	68	67	67	63
SDECB/Z-160-4T-0.25	0,18	1340	60	21	19	19	19	20	20	21	21	21	20						

MOD.	kW	r.p.m	dB	CAPACIDAD (m³/s)																	
				0,23	0,27	0,3	0,33	0,37	0,42	0,47	0,52	0,58	0,67	0,75	0,83	0,93	1,05	1,17	1,33	1,5	1,67
				PRESIÓN TOTAL (mmH ₂ O)																	
SDECB/Z-260-4T-0.75	0,55	1360	63			42	44	45	45	46	45	42	40								
SDECB/Z-280-4T-0.75	0,55	1360	64			45	46	47	48	46	45	42	40								
SDECB/Z-300-4T-0.75	0,55	1360	65			47	49	50	50	51	50	48	47								
SDECB/Z-330-4T-1.5	1,1	1380	72						65	68	70	71	71	70	69	67	65				
SDECB/Z-380-4T-3	2,2	1410	73											85	86	87	89	90	90	86	80
SDECB/Z-400-4T-4	3	1410	74												90	90	92	95	96	100	95

Margen sobre el caudal ±5%

Margen del nivel sonoro +3...5 db

Características T=15°C e 760 mmHg.

Dimensiones mm

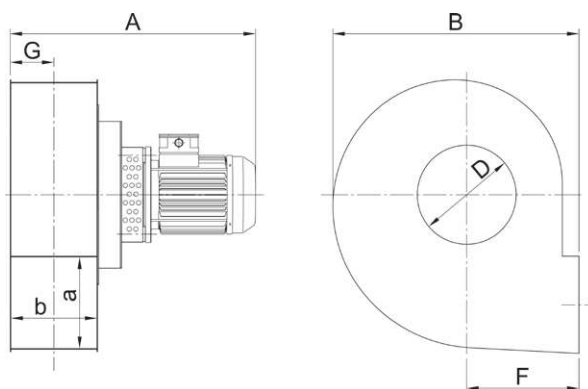

MOD.	kW	r.p.m	A	B	F	G	D	a x b	Kg
SDECB/Z-160-2T-0.75	0,55	2810	411	290	138	57	127	103 x 110	15
SDECB/Z-160-4T-0.25	0,18	1340	411	290	138	57	127	103 x 110	15
SDECB/Z-260-4T-0.75	0,55	1360	470	370	170	71	190	199 x 138	26
SDECB/Z-280-4T-0.75	0,55	1360	470	434	170	72	215	210 x 140	29
SDECB/Z-300-4T-0.75	0,55	1360	515	520	235	92	207	199 x 180	32
SDECB/Z-330-4T-1.5	1,10	1380	530	490	210	92	237	261 x 180	36
SDECB/Z-380-4T-3	2,20	1410	670	610	280	112	270	254 x 220	58
SDECB/Z-400-4T-4	3,00	1410	700	670	300	112	300	280 x 240	73

Curvas Características

SDECB/Z 160

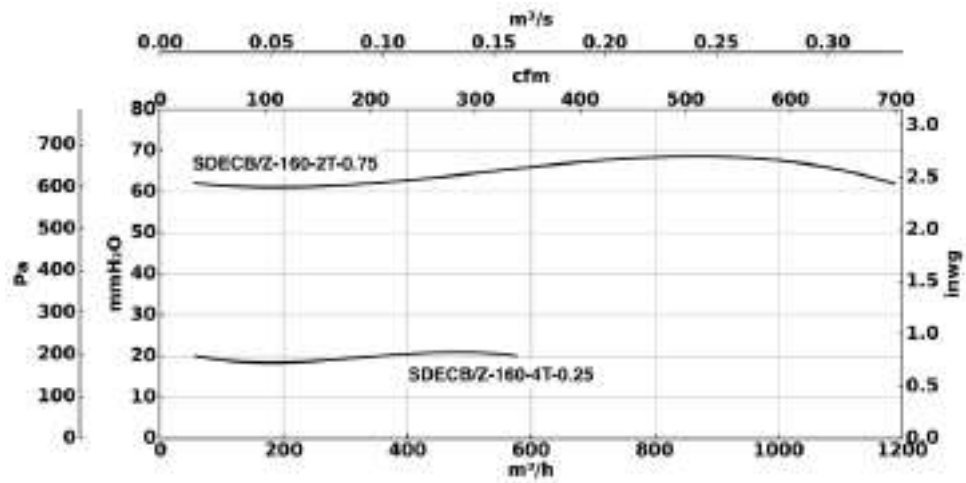

SDECB/Z 260...300

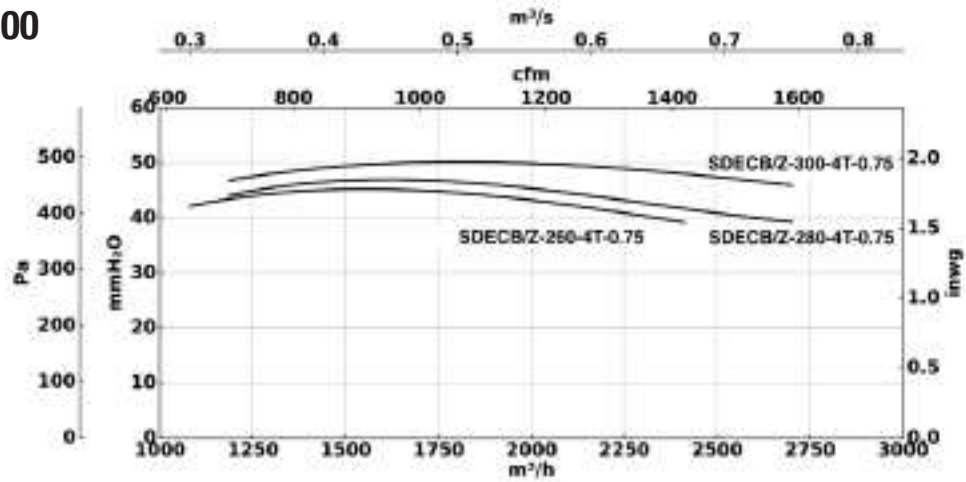

SDECB/Z 330...400

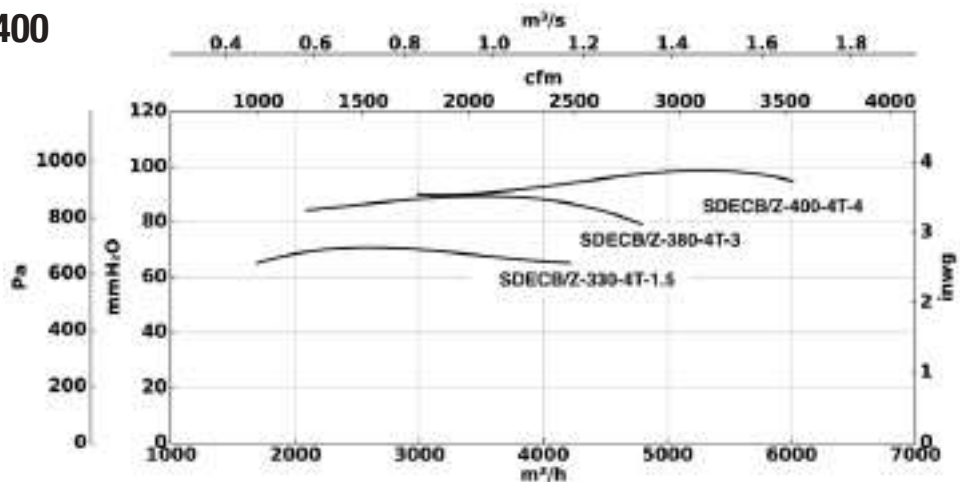

Presión total

Margen sobre el caudal ± 5 %
 Margen del nivel sonoro +3...5 db
 Margen kW absorbidos ± 3%

SDLM/F

Ventiladores centrífugos especialmente diseñados para la extracción de aire caliente en hornos máx. 300 °C y salida de aire horizontal



Especialmente diseñados para hornos de panadería y pastelería y hornos de tratamiento de superficies



Ventilador:

- Envoltente en chapa de acero.
- Turbina a acción en chapa de acero galvanizado.
- Motor directamente acoplado con brida B-5.
- Con uno o dos rodetes de refrigeración montados sobre el eje del motor para disipar la temperatura.

y 400/690 V 50 Hz (potencias superiores a 4 kW).

- Temperatura máxima del aire a transportar: -25 °C +300 °C.

Acabado:

- Anticorrosivo con pintura anticorrosiva resistente a la temperatura, color aluminio.

Bajo demanda:

- Bobinados especiales para diferentes tensiones.
- Envoltente del ventilador en acero inoxidable.

Motor:

- Motores con eficiencia IE3 para potencias iguales o superiores a 0,75 kW, excepto monofásicos, 2 velocidades y 8 polos.
- Protección IP55.
- Trifásicos 230/400 V 50 Hz (hasta 4 kW)

Características

MOD.	kW	r.p.m	dB/A	CAPACIDAD (m³/s)															
				0,12	0,13	0,15	0,17	0,18	0,2	0,23	0,27	0,3	0,33	0,37	0,42	0,47	0,53	0,6	0,67
				PRESIÓN TOTAL (mmH₂O)															
SDLM/F-25-4T-0.75	0,55	1360	51	31	32	33	34	35	36	38	40	40	41	40	40	39	34		
SDLM/F-28-4T-1	0,75	1360	56						38	40	42	44	45	47	48	50	52	52	50
SDLM/F-29-4T-1.5	1,1	1380	56							37	39	40	42	44	45	47	48	50	
SDLM/F-33-4T-1.5	1,1	1380	56						60	61	62	62	63	64	65	68	70	72	75
SDLM/F-36-4T-3	2,2	1410	61									71	71	72	74	75	75	76	77
SDLM/F-39-4T-3	2,2	1410	73										84	85	86	87	89	92	95

MOD.	kW	r.p.m	dB/A	CAPACIDAD (m³/s)															
				0,76	0,83	0,92	1	1,17	1,33	1,5	1,67	1,83	2	2,33					
				PRESIÓN TOTAL (mmH₂O)															
SDLM/F-28-4T-1	0,75	1360	56	45	40														
SDLM/F-29-4T-1.5	1,1	1380	56	52	50	47	40												
SDLM/F-33-4T-1.5	1,1	1380	56	76	75	73	70	60											
SDLM/F-36-4T-3	2,2	1410	61	81	82	85	89	89	90	87	81	72	65						
SDLM/F-39-4T-3	2,2	1410	73	97	100	102	105	113	115	118	119	118	118	113					

Margen sobre el caudal ±5%
Margen del nivel sonoro +3...5 db

Dimensiones mm

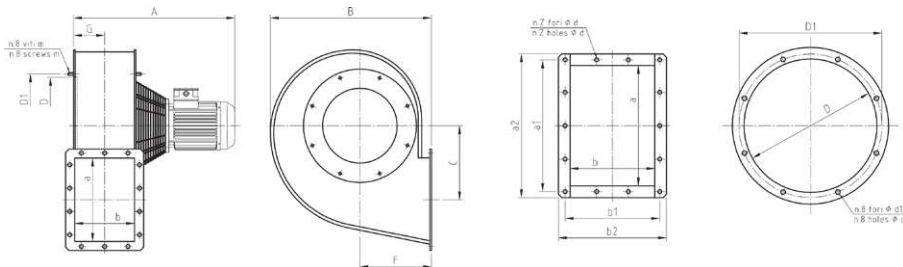

MOD.	kW	r.p.m	A	B	C	F	G	D	D1	m	a x b	Kg
SDLM/F-25-4T-0.75	0,55	1360	520	430	175	190	82	260	280	M6	225 x 160	28
SDLM/F-28-4T-1	0,75	1360	545	485	222	215	94	290	310	M8	250 x 180	30
SDLM/F-29-4T-1.5	1,1	1380	560	485	222	215	94	290	310	M8	250 x 180	35
SDLM/F-33-4T-1.5	1,1	1380	580	570	255	250	104	350	370	M8	296 x 200	50
SDLM/F-36-4T-3	2,2	1410	635	570	255	250	104	380	405	M8	296 x 200	60
SDLM/F-39-4T-3	2,2	1410	635	680	308	300	129	400	430	M8	356 x 250	90

BOCA DE IMPULSIÓN

MOD.	a x b	a1	b1	a2	b2	Z	d	d1
SDLM/F-25-4T-0.75	226 x 161	251	186	276	211	10	12	8
SDLM/F-28-4T-1	254 x 185	280	210	304	235	14	12	10
SDLM/F-29-4T-1.5	254 x 185	280	210	304	235	14	12	10
SDLM/F-33-4T-1.5	299 x 205	325	230	349	255	14	12	10
SDLM/F-36-4T-3	299 x 205	325	230	349	255	14	12	10
SDLM/F-39-4T-3	361 x 255	395	285	431	325	14	12	10

HORNO

Curvas Características

SDLM/F 25...29

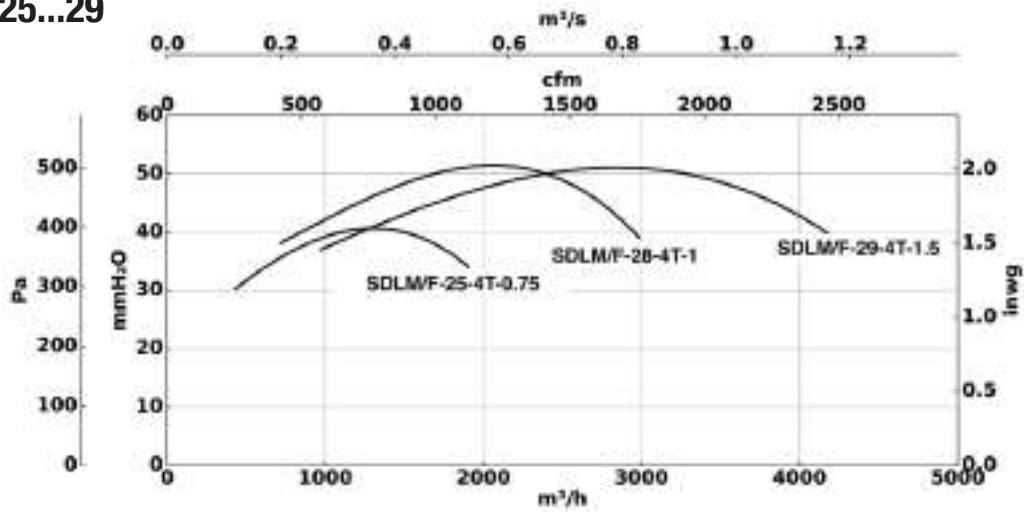

SDLM/F 33...39

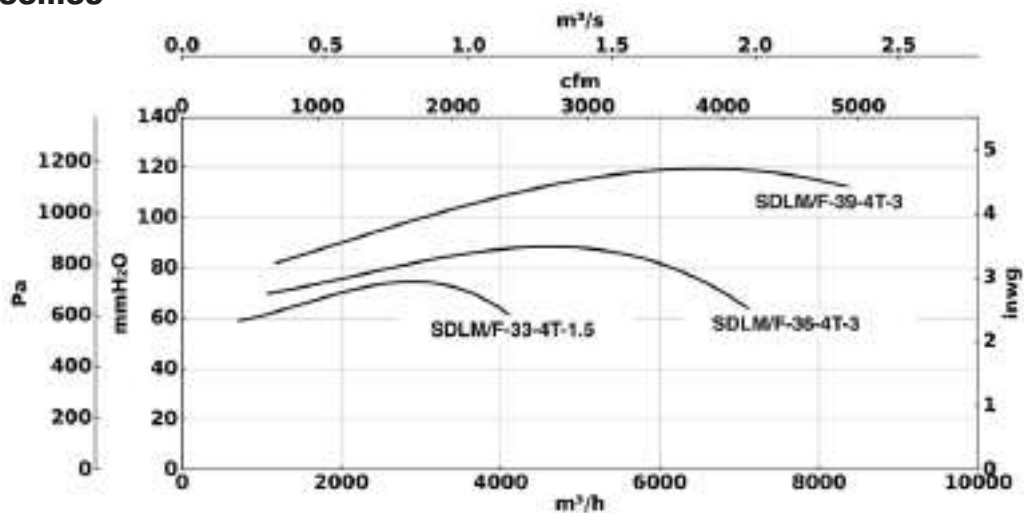

Presión total

- Margen sobre el caudal ± 5 %
- Margen del nivel sonoro +3...5 db
- Margen kW absorbidos ± 3%

CMRH



Ventiladores accionados a transmisión, equipados con motor eléctrico, conjunto de poleas, correas y protectores normalizados según norma ISO-13857 y cajón calorifugado con fibra mineral de 150 mm, para trabajo horizontal



Ventilador:

- Estructura en chapa de acero de gran espesor.
- Turbina a reacción en chapa de acero de gran robustez.
- Grupo de transmisión con rodamientos y soporte en fundición.

Motor:

- Motores con eficiencia IE3 para potencias iguales o superiores a 0,75 kW, excepto monofásicos, 2 velocidades y 8 polos.
- Motores clase F con rodamientos a bolas. Protección IP55.
- Trifásicos 230/400 V 50 Hz (hasta 4 kW) y 400/690 V 50 Hz (potencias superiores a 4 kW).
- Temperatura máxima del aire a transportar: -20 °C +300 °C.

Acabado:

- Tratamiento con pintura anticorrosiva.

Bajo demanda:

- Bobinados especiales para diferentes tensiones.
- Ventilador en acero refractario para temperaturas de hasta 400 °C.
- Ejecución para trabajo vertical.



Engrasadores externos para facilitar el mantenimiento

Código de pedido

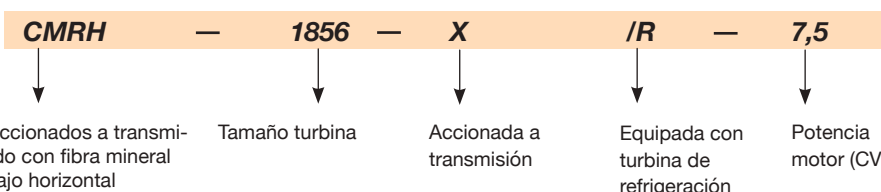

Características técnicas

Modelo	Velocidad (r/min)	Intensidad máxima admisible (A)			Potencia instalada (kW)	Caudal máximo (m³/h)	Nivel presión sonora dB(A)	Peso aprox. (Kg)
		230V	400V	690V				
CMRH-1445-X/R-3 IE3	1700	7,93	4,56		2,20	9620	79	204
CMRH-1445-X/R-4 IE3	1910	10,70	6,15		3,00	10810	81	212
CMRH-1445-X/R-5.5 IE3	2120	13,90	8,00		4,00	12000	83	228
CMRH-1650-X/R-4 IE3	1530	10,70	6,15		3,00	9910	80	217
CMRH-1650-X/R-5.5 IE3	1720	13,90	8,00		4,00	11140	82	233
CMRH-1650-X/R-7.5 IE3	1910		10,30	5,97	5,50	12370	84	273
CMRH-1856-X/R-5.5 IE3	1365	13,90	8,00		4,00	14210	79	243
CMRH-1856-X/R-7.5 IE3	1535		10,30	5,97	5,50	15980	81	283
CMRH-1856-X/R-10 IE3	1705		13,90	8,06	7,50	17780	83	273
CMRH-2063-X/R-7.5 IE3	1365		10,30	5,97	5,50	22860	82	288
CMRH-2063-X/R-10 IE3	1515		13,90	8,06	7,50	25370	84	278
CMRH-2063-X/R-15 IE3	1700		20,90	12,10	11,00	28470	86	305
CMRH-2271-X/R-15 IE3	1370		20,90	12,10	11,00	32300	87	350
CMRH-2271-X/R-20 IE3	1540		27,90	16,20	15,00	36300	90	375
CMRH-2380-X/R-25 IE3	1280		35,10	20,30	18,50	43885	83	405
CMRH-2380-X/R-30 IE3	1365		41,00	23,80	22,00	46800	85	422

Dimensiones mm

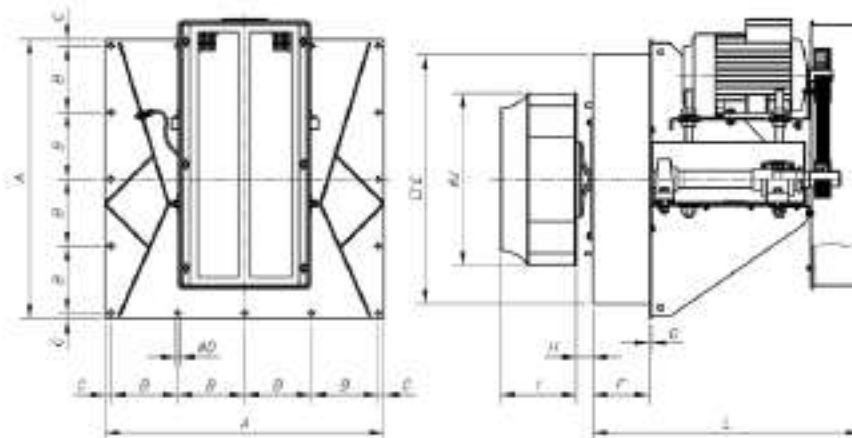

	A	B	C	øD	E	F	G	H	I	øJ	L
CMRH-1445-X/R-3	740	177	16	12	660	150	5	43	202	458	710
CMRH-1445-X/R-4	740	177	16	12	660	150	5	43	202	458	710
CMRH-1445-X/R-5'5	740	177	16	12	660	150	5	43	202	458	710
CMRH-1650-X/R-4	740	177	16	12	660	150	5	43	224	508	710
CMRH-1650-X/R-5'5	740	177	16	12	660	150	5	43	224	508	710
CMRH-1650-X/R-7'5	740	177	16	12	660	150	5	43	224	508	710
CMRH-1856-X/R-4	800	192	16	12	720	150	5	43	245,5	573	816
CMRH-1856-X/R-5'5	800	192	16	12	720	150	5	43	245,5	573	816
CMRH-1856-X/R-7'5	800	192	16	12	720	150	5	43	245,5	573	816
CMRH-2063-X/R-7'5	800	192	16	12	720	150	5	43	274	644	816
CMRH-2063-X/R-10	800	192	16	12	720	150	5	43	274	644	816
CMRH-2063-X/R-15	800	192	16	12	720	150	5	43	274	644	816
CMRH-2271-X/R-15	970	233	20	14	870	150	5	43	295	719	817
CMRH-2271-X/R-20	970	233	20	14	870	150	5	43	295	719	817
CMRH-2380-X/R-25	970	232,5	20	14	870	150	5	53,5	400	810	902
CMRH-2380-X/R-30	970	232,5	20	14	870	150	5	53,5	400	810	902

Curvas Características

Q= Caudal en m³/h, m³/s y cfm

Pe= Presión estática en mmH₂O, Pa e inwg

CMRH 1445

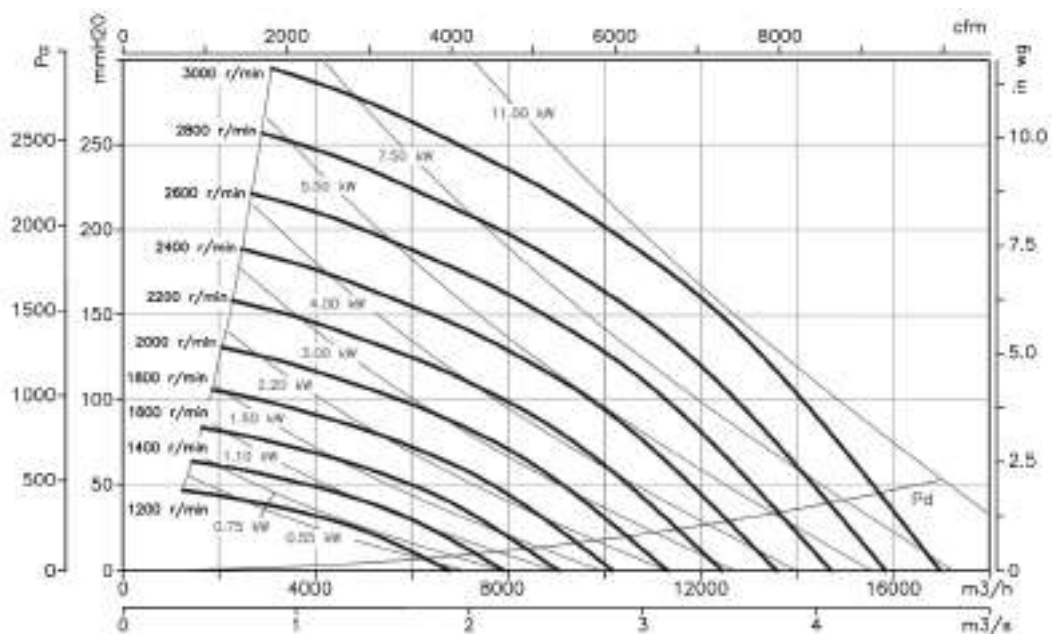

Curvas Características

Q= Caudal en m³/h, m³/s y cfm

Pe= Presión estática en mmH₂O, Pa e inwg

CMRH 1650

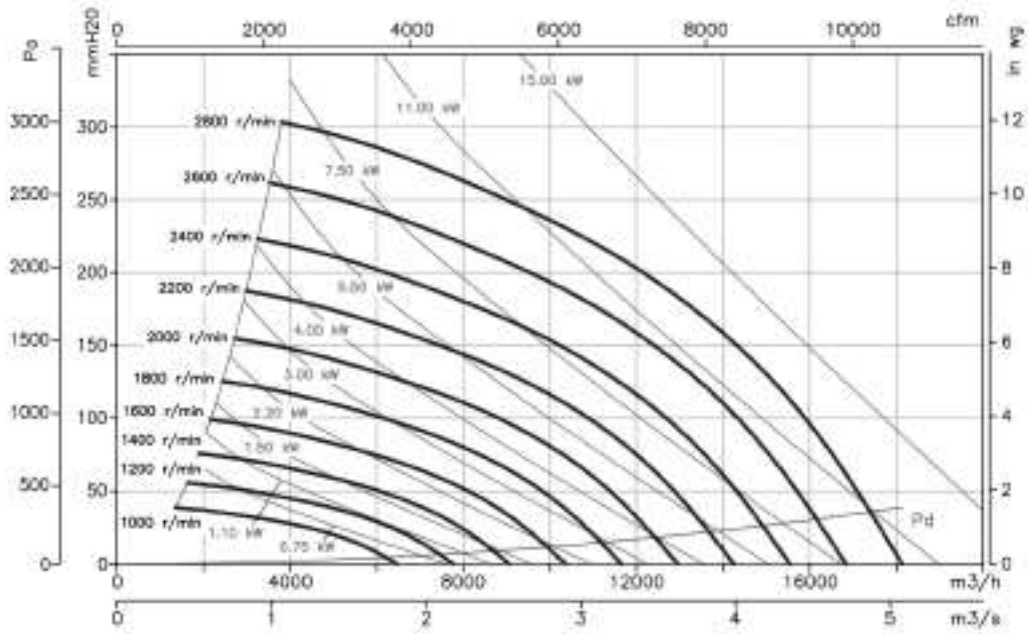

CMRH 1856

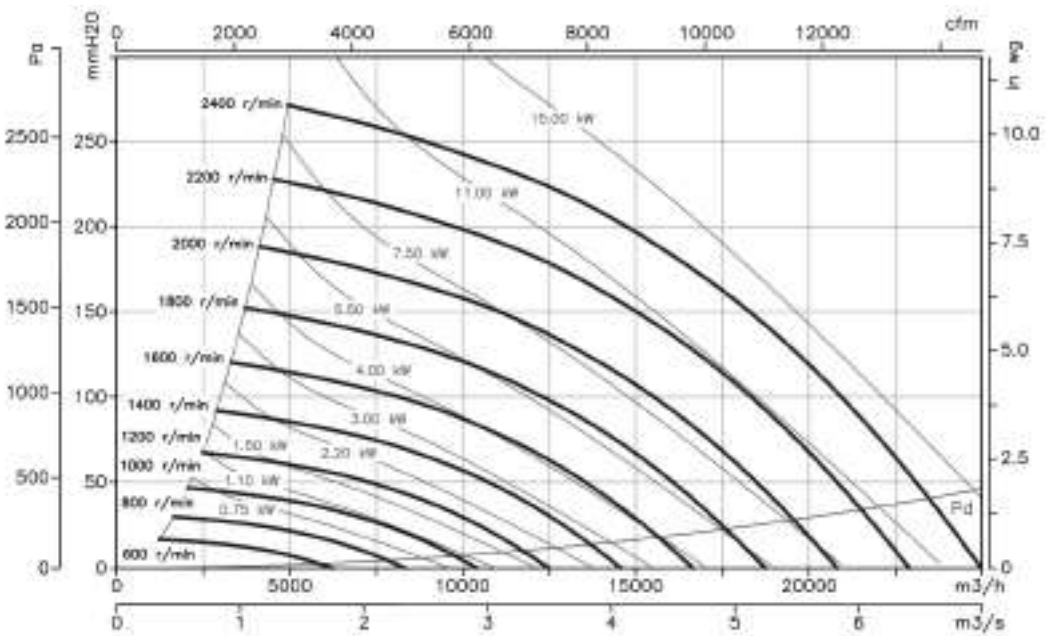

Curvas Características

Q= Caudal en m³/h, m³/s y cfm

Pe= Presión estática en mmH₂O, Pa e in wg

CMRH 2063

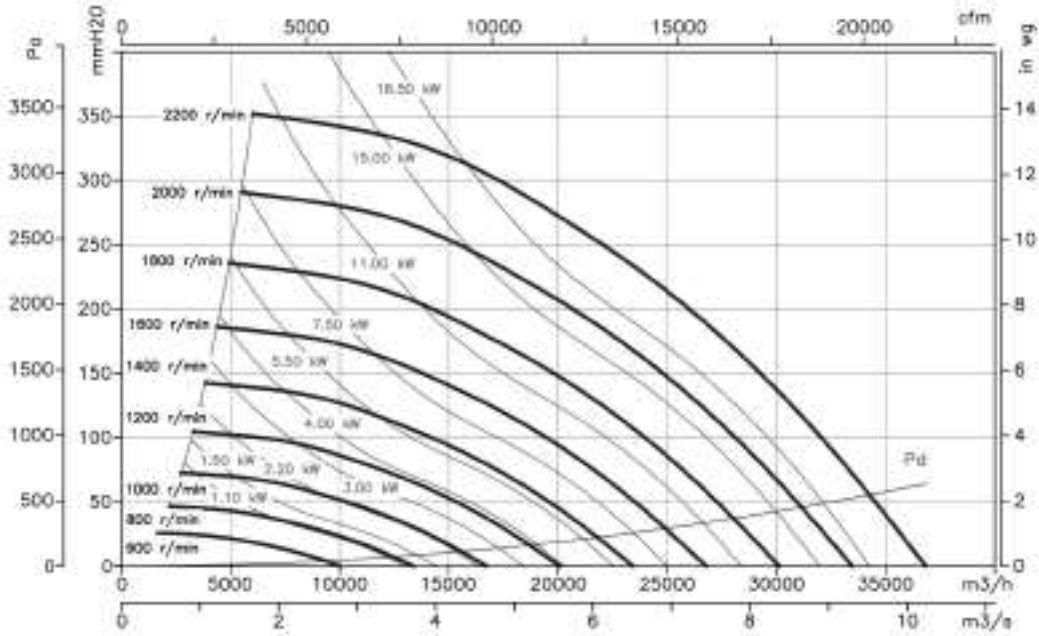

CMRH 2271

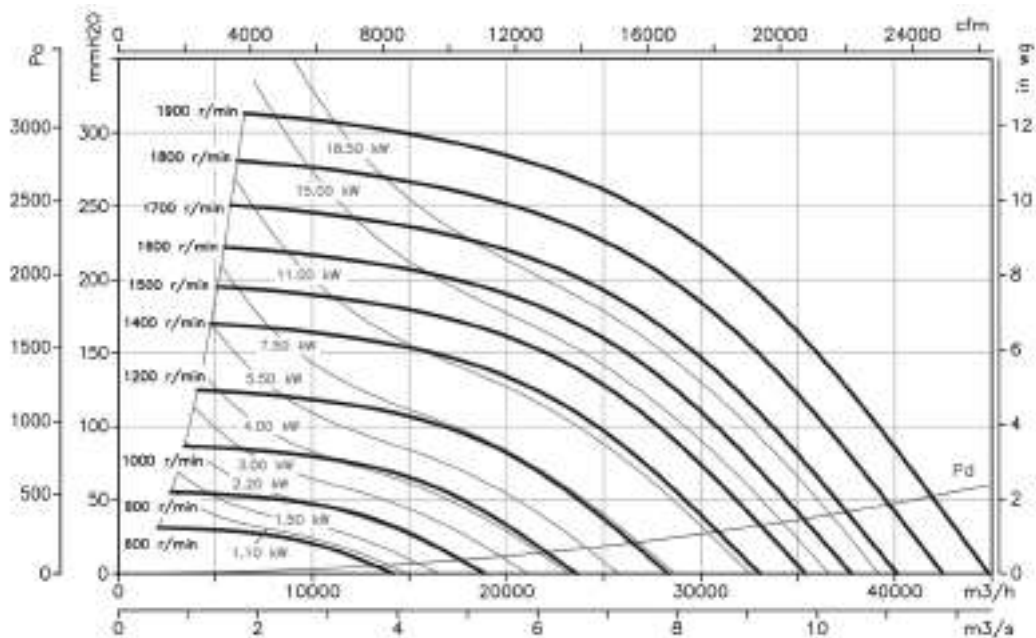

Curvas Características

Q= Caudal en m³/h, m³/s y cfm Pe= Presión estática en mmH₂O, Pa e inwg

CMRH 2380

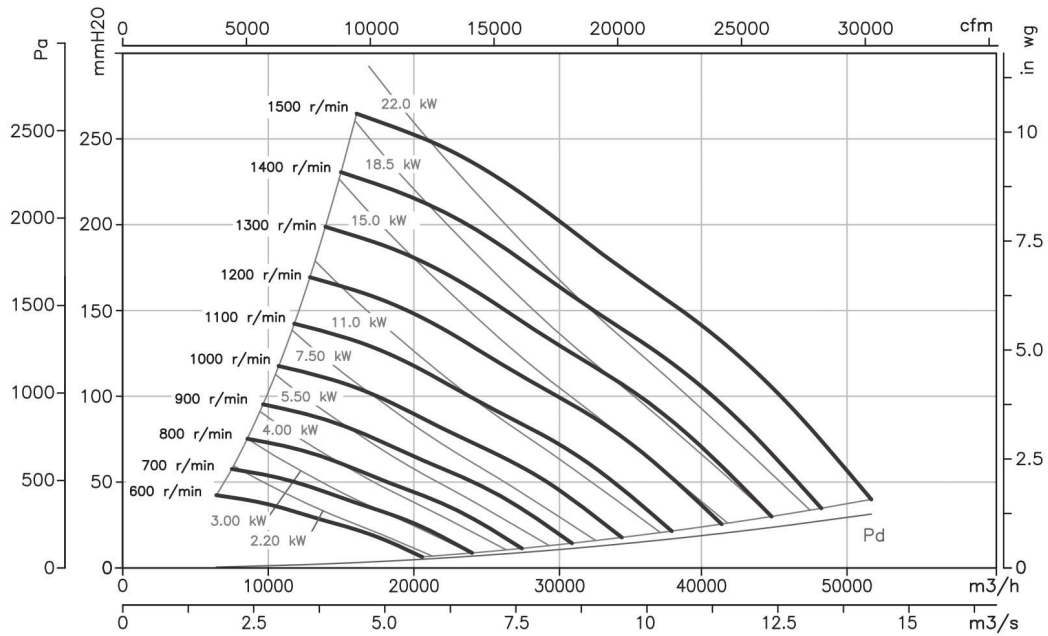

Accesorios



INT

C2V

RM

VSD3/A-RFT
VSD1/A-RFM

AET

ARO

VOL

Drall-Regler

Válvula lamas contrapuestas

CMSH

Ventiladores centrífugos de media presión, equipados con turbina a reacción y cajón calorifugado con fibra mineral



Ventilador:

- Estructura en chapa de acero.
- Turbina a reacción en chapa de acero.
- Cajón calorífico con fibra mineral de alta densidad y gran aislamiento térmico y acústico.
- Con fibra mineral de 30 mm de grosor.

Motor:

- Motores con eficiencia IE3 para potencias iguales o superiores a 0,75 kW, excepto monofásicos, 2 velocidades y 8 polos. Protección IP55.
- Motores clase F con rodamientos a bolas.
- Trifásicos 230/400 V 50 Hz (hasta 4 kW) y 400/690 V 50 Hz (potencias superiores a 4 kW).
- Temperatura máxima del aire a transportar: -20 °C +250 °C.

Acabado:

- Tratamiento con pintura anticorrosiva.

Bajo demanda:

- Bobinados especiales para diferentes tensiones.
- Construcción en acero inoxidable.



Cajón aislado con fibra mineral de alto poder térmico

Código de pedido

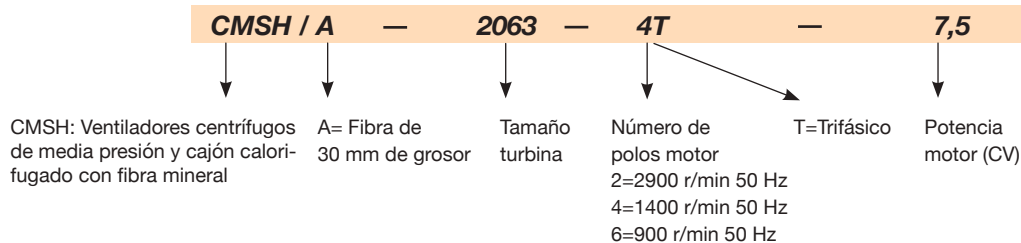

Características técnicas

Modelo	Velocidad (r/min)	Intensidad máxima admisible (A)			Potencia instalada (kW)	Caudal máximo (m³/h)	Nivel presión sonora dB(A)	Peso aprox. (Kg)
		230V	400V	690V				
CMSH-831-2T-2 IE3	2875	5,34	3,07		1,50	2650	65	31
CMSH-935-2T-2 IE3	2875	5,34	3,07		1,50	3660	70	39
CMSH-1040-4T-1.5 IE3	1455	4,07	2,34		1,10	2660	57	36
CMSH-1145-4T-1.5 IE3	1455	4,07	2,34		1,10	3940	61	58
CMSH-1240-4T-1.5 IE3	1455	4,07	2,34		1,10	5300	62	57
CMSH-1445-4T-2 IE3	1440	5,41	3,11		1,50	8450	70	69
CMSH-1650-4T-3 IE3	1435	7,93	4,56		2,20	10900	71	80
CMSH-1856-4T-5.5 IE3	1450	13,90	8,00		4,00	17100	77	93
CMSH-2063-4T-7.5 IE3	1465		10,30	5,97	5,50	19200	77	150
CMSH-2063-6T-3 IE3	950	9,08	5,22		2,20	13600	66	125
CMSH-2271-4T-15 IE3	1470		20,90	12,10	11,00	31000	83	196
CMSH-2271-4T-20 IE3	1465		27,90	16,20	15,00	34600	85	205
CMSH-2271-6T-5.5 IE3	960	15,60	8,99		4,00	21900	75	150
CMSH-2380-4T-30 IE3	1470		41,00	23,80	22,00	47600	86	266
CMSH-2380-6T-15 IE3	975		21,90	12,70	11,00	30900	78	279

Características acústicas

Espectro de potencia sonora Lw(A) en dB(A) por banda de frecuencia en Hz.

	63	125	250	500	1000	2000	4000	8000
CMSH-831-2T-2	54	63	68	68	72	71	64	58
CMSH-935-2T-2	59	68	73	73	77	76	69	63
CMSH-1040-4T-1,5	50	56	61	62	65	67	59	53
CMSH-1145-4T-1,5	56	62	67	68	71	73	65	59
CMSH-1240-4T-1,5	46	59	61	73	69	67	64	56
CMSH-1445-4T-2	55	65	78	81	79	79	75	65
CMSH-1650-4T-3	52	65	79	79	82	80	77	67
CMSH-1856-4T-5,5	64	71	88	88	87	87	86	83

	63	125	250	500	1000	2000	4000	8000
CMSH-2063-4T-7,5	66	72	91	86	86	86	83	74
CMSH-2063-6T-3	58	69	76	77	78	77	71	61
CMSH-2271-4T-15	73	79	97	96	94	94	91	83
CMSH-2271-4T-20	75	81	99	98	96	96	93	85
CMSH-2271-6T-5,5	65	78	79	83	92	86	82	71
CMSH-2380-4T-30	76	82	100	99	97	97	94	86
CMSH-2380-6T-15	68	81	82	86	95	89	85	74

Dimensiones mm

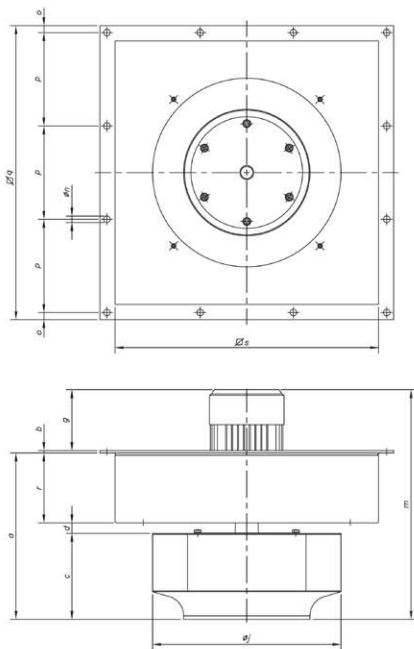

	a	b	c	d	g	øj	m	øñ	o	p	q	r	s
CMSH-831-2T-2	253,5	3	83	20,5	174	315	432	9	15	150	480	150	400
CMSH-935-2T-2	265,5	3	93,5	22	186	350	454,5	14	20	188	604	150	495
CMSH-1040-4T-1'5	273,5	3	103,5	22	186	400	464	14	15	188	604	150	495
CMSH-1145-4T-1'5	283,5	5	114	19,5	186,5	450	475	14	15	200	630	150	565
CMSH-1240-4T-1'5	356,5	5	184	22,5	130,5	404	492	14	15	200	630	150	565
CMSH-1445-4T-2	397,5	5	220	27,5	186,6	458	589	14	15	200	630	150	565
CMSH-1650-4T-3	428	5	248	27,5	216	508	649	14	16	236	740	150	673
CMSH-1856-4T-5'5	449,5	5	277,5	22	216	577	671	14	16	236	740	150	673
CMSH-2063-4T-7'5	470	5	299	21	277,5	644	752,5	14	19	284	890	150	813
CMSH-2063-6T-3	470	5	299	21	239,5	644	714,5	14	19	284	890	150	813
CMSH-2271-4T-15	500	5	330	20	395,5	719	900,5	14	19	284	890	150	813
CMSH-2271-4T-20	500	5	330	20	395,5	719	900,5	14	19	284	890	150	813
CMSH-2271-6T-5'5	466	5	295	21	277,5	719	748,5	14	19	284	890	150	813
CMSH-2380-4T-30	538,5	5	366	22,5	538,5	808	1056	14	19	248	1030	150	953
CMSH-2380-6T-15	538,5	5	366	22,5	395,5	808	939	14	19	248	1030	150	953

Accesorios



INT

C2V

RM

VSD3/A-RFT
VSD1/A-RFM

AET

ARO

Curvas Características

Q= Caudal en m³/h, m³/s y cfm

Pe= Presión estática en mmH₂O, Pa e inwg

CMSH 831...935

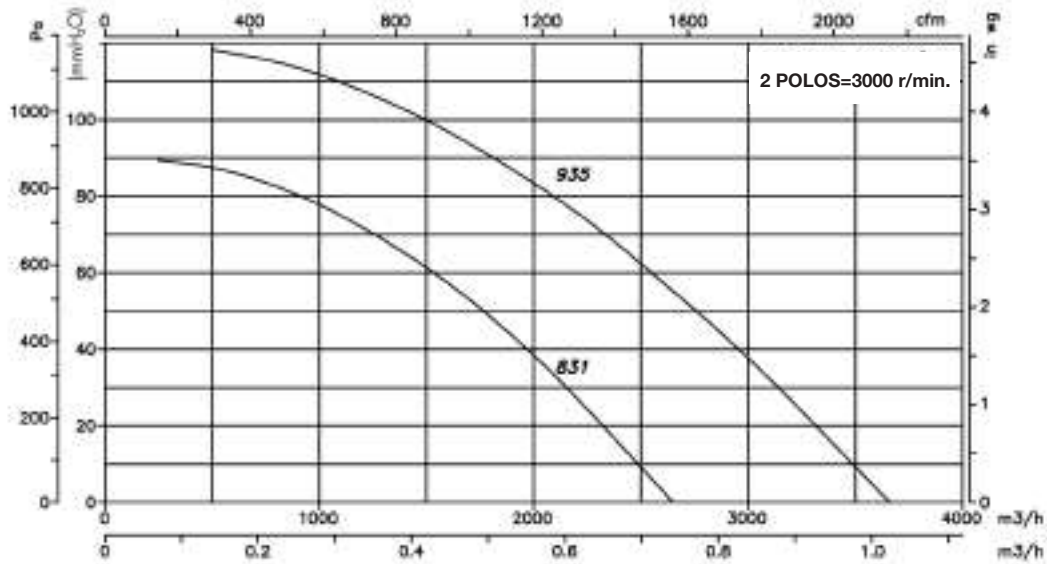

CMSH 1040...1650

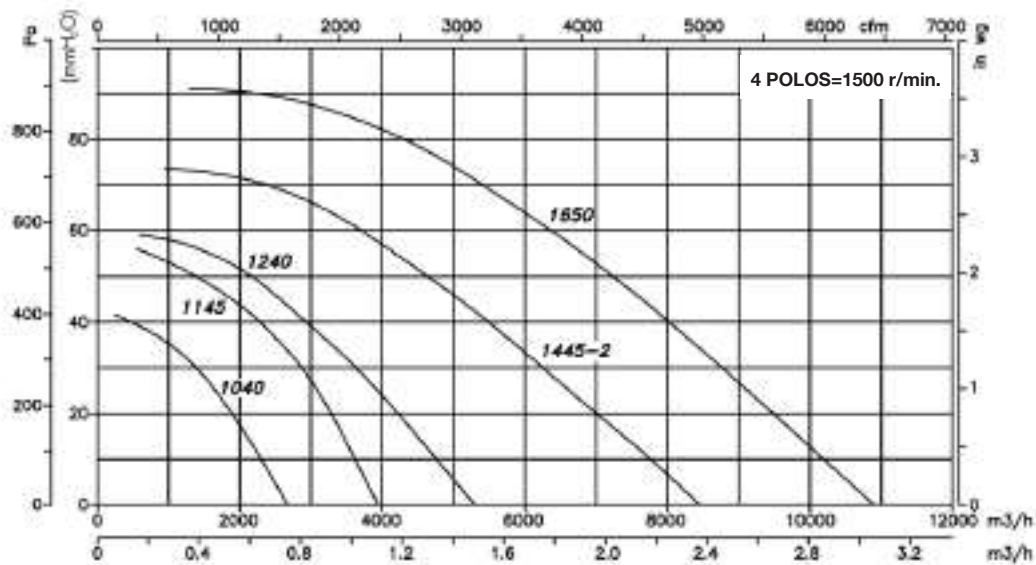

Curvas Características

Q= Caudal en m³/h, m³/s y cfm

Pe= Presión estática en mmH₂O, Pa e inwg

CMSH 1856...2380

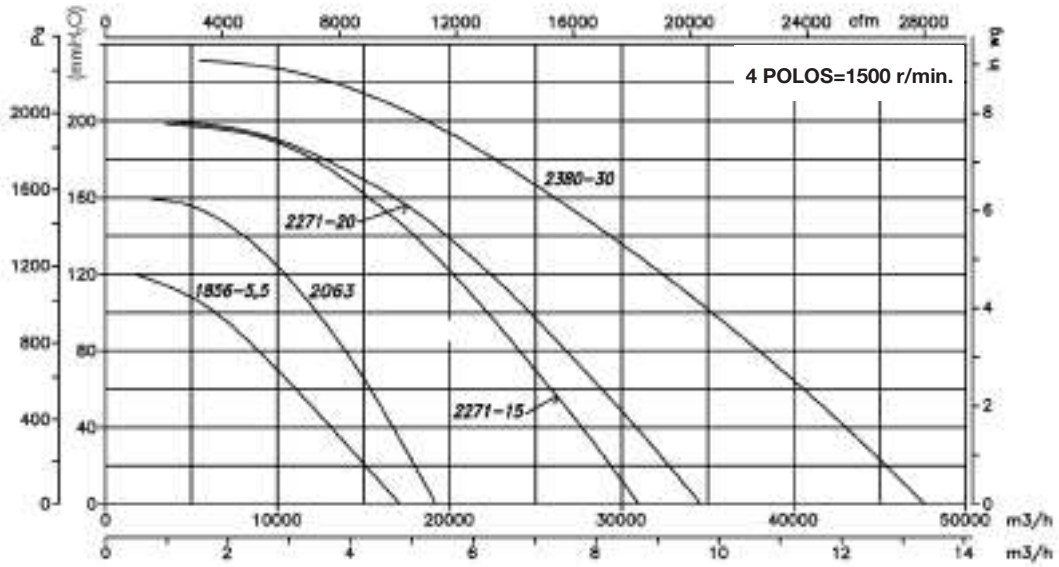

CMSH 2063...2380

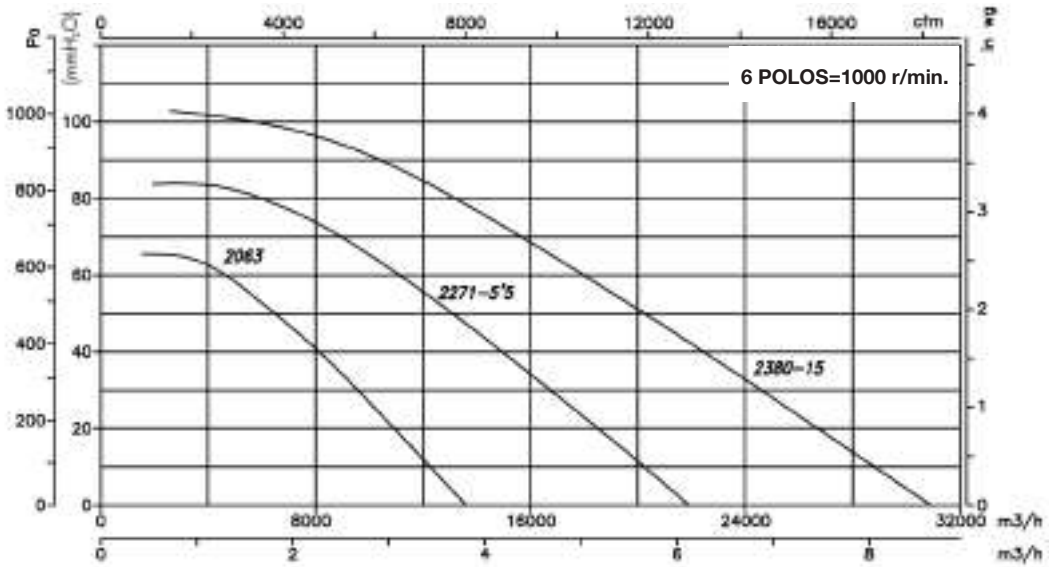

CMPH

Ventiladores centrífugos de media presión, equipados con turbina a acción y cajón calorifugado con fibra mineral



Ventilador:

- Estructura en chapa de acero.
- Turbina a acción en chapa de acero galvanizado.
- Cajón calorífico con fibra mineral de alta densidad y gran aislamiento térmico y acústico.

Motor:

- Motores clase F con rodamientos a bolas. Protección IP55.
- Motores con eficiencia IE3 para potencias iguales o superiores a 0,75 kW, excepto monofásicos, 2 velocidades y 8 polos.
- Trifásicos 230/400 V 50 Hz (hasta 4 kW) y 400/690 V 50 Hz (potencias superiores a 4 kW).
- Temperatura máxima del aire a transportar: -20 °C +250 °C.

Acabado:

- Tratamiento con pintura anticorrosiva.

Bajo demanda:

- Bobinados especiales para diferentes tensiones.
- Construcción en acero inoxidable.



Cajón aislado con fibra mineral de alto poder térmico

Código de pedido

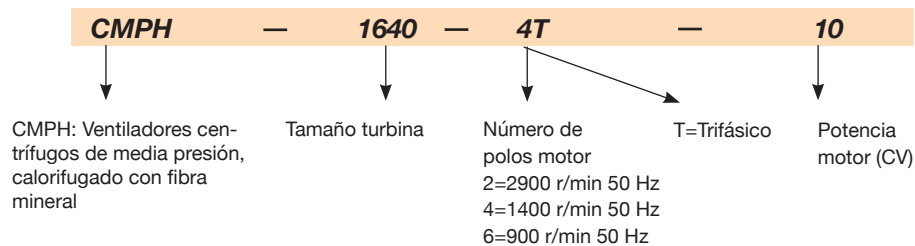

Características técnicas

Modelo	Velocidad (r/min)	Intensidad máxima admisible (A)			Potencia instalada (kW)	Caudal máximo (m³/h)	Nivel presión sonora dB(A)	Peso aprox. (Kg)
		230V	400V	690V				
CMPH-512-2T-0.25	2750	1,21	0,70		0,18	475	62	7
CMPH-512-4T-0.16	1320	0,96	0,56		0,12	255	55	7
CMPH-514-2T-0.25	2750	1,21	0,70		0,18	800	65	11
CMPH-514-4T-0.16	1320	0,96	0,56		0,12	565	58	11
CMPH-616-2T-0.5	2710	1,92	1,11		0,37	1380	69	13
CMPH-616-4T-0.16	1320	0,96	0,56		0,12	850	61	11
CMPH-620-2T-0.5	2710	1,92	1,11		0,37	765	68	15
CMPH-620-4T-0.16	1320	0,96	0,56		0,12	810	61	13
CMPH-718-2T-1 IE3	2825	2,80	1,62		0,75	1485	70	23
CMPH-718-4T-0.33	1350	1,52	0,88		0,25	1280	63	15
CMPH-820-2T-1.5 IE3	2830	4,03	2,34		1,10	1950	73	21
CMPH-820-4T-0.33	1350	1,52	0,88		0,25	1670	66	15
CMPH-922-2T-1.5 IE3	2830	4,03	2,34		1,10	1650	70	25
CMPH-922-2T-2 IE3	2875	5,34	3,07		1,50	2010	71	31
CMPH-922-2T-3 IE3	2910	7,32	4,21		2,20	2600	74	34
CMPH-922-4T-0.75	1380	2,92	1,69		0,55	2450	66	22
CMPH-1025-2T-3 IE3	2910	7,32	4,21		2,20	2100	73	35
CMPH-1025-2T-4 IE3	2910	10,00	5,77		3,00	2830	77	41

Características técnicas

Modelo	Velocidad (r/min)	Intensidad máxima admisible (A)			Potencia instalada (kW)	Caudal máximo (m³/h)	Nivel presión sonora dB(A)	Peso aprox. (Kg)
		230V	400V	690V				
CMPH-1025-4T-1.5 IE3	1455	4,07	2,34		1,10	3400	70	31
CMPH-1128-2T-4 IE3	2910	10,00	5,77		3,00	2220	77	46
CMPH-1128-2T-5.5 IE3	2900	13,00	7,50		4,00	3210	81	59
CMPH-1128-4T-3 IE3	1435	7,93	4,56		2,20	5000	74	45
CMPH-1128-6T-1 IE3	940	3,36	1,93		0,75	3300	60	39
CMPH-1231-4T-3 IE3	1435	7,93	4,56		2,20	4740	73	45
CMPH-1231-4T-4 IE3	1440	10,70	6,15		3,00	5910	75	51
CMPH-1231-4T-5.5 IE3	1450	13,90	8,00		4,00	6850	77	53
CMPH-1231-6T-2 IE3	950	6,43	3,70		1,50	5115	64	47
CMPH-1435-4T-4 IE3	1440	10,70	6,15		3,00	5560	76	52
CMPH-1435-4T-5.5 IE3	1450	13,90	8,00		4,00	6260	78	55
CMPH-1435-4T-7.5 IE3	1465		10,30	5,97	5,50	7210	80	90
CMPH-1435-6T-3 IE3	950	9,08	5,22		2,20	6400	66	54
CMPH-1640-4T-5.5 IE3	1450	13,90	8,00		4,00	7500	77	67
CMPH-1640-4T-7.5 IE3	1465		10,30	5,97	5,50	8035	80	102
CMPH-1640-4T-10 IE3	1465		13,90	8,06	7,50	9710	82	106
CMPH-1640-6T-3 IE3	950	9,08	5,22		2,20	8100	71	66
CMPH-1845-4T-7.5 IE3	1465		10,30	5,97	5,50	8965	82	113
CMPH-1845-4T-10 IE3	1465		13,90	8,06	7,50	10350	85	117
CMPH-1845-6T-3 IE3	950	9,08	5,22		2,20	8330	77	77
CMPH-2050-4T-10 IE3	1465		13,90	8,06	7,50	9000	83	128
CMPH-2050-4T-15 IE3	1470		20,90	12,10	11,00	12525	87	156
CMPH-2050-4T-20 IE3	1465		27,90	16,20	15,00	19000	89	167
CMPH-2050-6T-5.5 IE3	960	15,60	8,99		4,00	11000	79	122
CMPH-2563-6T-15 IE3	975		21,90	12,70	11,00	16500	86	202
CMPH-2563-6T-25 IE3	980		35,90	20,80	18,50	28000	87	306

Características acústicas

Espectro de potencia sonora Lw(A) en dB(A) por banda de frecuencia en Hz.

	63	125	250	500	1000	2000	4000	8000		63	125	250	500	1000	2000	4000	8000
CMPH-512-2T-0,25	37	47	58	65	69	66	64	57	CMPH-1128-6T-1	35	45	56	63	67	64	62	55
CMPH-512-4T-0,16	30	40	51	58	62	59	57	50	CMPH-1231-4T-3	51	60	71	78	82	80	78	71
CMPH-514-2T-0,25	40	50	61	68	72	69	67	60	CMPH-1231-4T-4	53	62	73	80	84	82	80	73
CMPH-514-4T-0,16	33	43	54	61	65	62	60	53	CMPH-1231-4T-5.5	55	64	75	82	86	84	82	75
CMPH-616-2T-0,5	44	54	65	72	76	73	71	64	CMPH-1231-6T-2	42	51	62	69	73	71	69	62
CMPH-616-4T-0,16	36	46	57	64	68	65	63	56	CMPH-1435-4T-4	54	63	74	81	85	83	81	74
CMPH-620-2T-0,5	43	53	64	71	75	72	70	63	CMPH-1435-4T-5.5	56	65	76	83	87	85	83	76
CMPH-620-4T-0,16	36	46	57	64	68	65	63	56	CMPH-1435-4T-7.5	58	67	78	85	89	87	85	78
CMPH-718-2T-1	45	55	66	73	77	74	72	65	CMPH-1435-6T-3	44	53	64	71	75	73	71	64
CMPH-718-4T-0,33	38	48	59	66	70	67	65	58	CMPH-1640-4T-5.5	55	64	75	82	86	84	82	75
CMPH-820-2T-1,5	48	58	69	76	80	77	75	68	CMPH-1640-4T-7.5	58	67	78	85	89	87	85	78
CMPH-820-4T-0,33	41	51	62	69	73	70	68	61	CMPH-1640-4T-10	60	69	80	87	91	89	87	80
CMPH-922-2T-1,5	45	55	66	73	77	74	72	65	CMPH-1640-6T-3	49	58	69	76	80	78	76	69
CMPH-922-2T-2	46	56	67	74	78	75	73	66	CMPH-1845-4T-7.5	61	71	82	89	93	91	89	81
CMPH-922-2T-3	49	59	70	77	81	78	76	69	CMPH-1845-4T-10	64	74	85	92	96	94	92	84
CMPH-922-4T-0,75	41	51	62	69	73	70	68	61	CMPH-1845-6T-3	56	66	77	84	88	86	84	76
CMPH-1025-2T-3	48	58	69	76	80	77	75	68	CMPH-2050-4T-10	62	72	83	90	94	92	90	82
CMPH-1025-2T-4	52	62	73	80	84	81	79	72	CMPH-2050-4T-15	66	76	87	94	98	96	94	86
CMPH-1025-4T-1.5	45	55	66	73	77	74	72	65	CMPH-2050-4T-20	68	78	89	96	100	98	96	88
CMPH-1128-2T-4	52	62	73	80	84	81	79	72	CMPH-2050-6T-5.5	58	68	79	86	90	88	86	78
CMPH-1128-2T-5.5	56	66	77	84	88	85	83	76	CMPH-2563-6T-15	67	77	88	95	99	96	94	87
CMPH-1128-4T-3	49	59	70	77	81	78	76	69	CMPH-2563-6T-25	68	78	89	96	100	97	95	88

Dimensiones mm

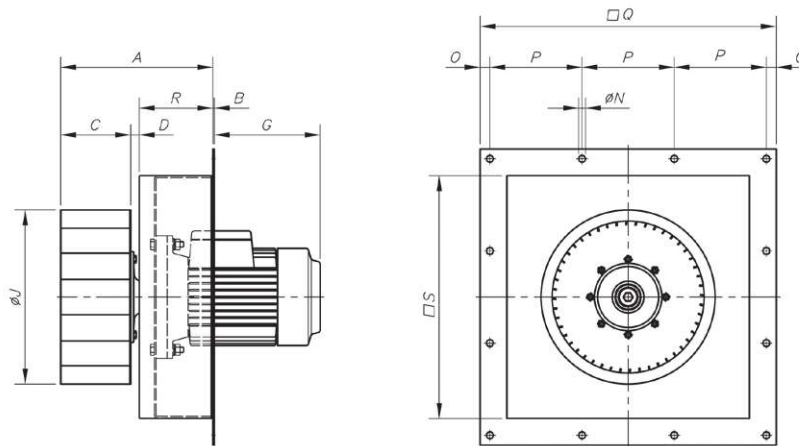

	A	B	C	D	G Max.	øJ	øN	O	P	Q	R	S
CMPH-512	108	3	50,5	6,5	159	120	7	12	97	315	50	260
CMPH-514	158,5	3	51,5	7	109	140	7	10	125	395	100	340
CMPH-616	169,5	3	62	6,5	155	160	7	10	125	395	100	353
CMPH-718	179,5	3	74	5	180	180	7	10	125	395	100	340
CMPH-620-2T-0,5	167	3	62	5	155	200	7	10	125	395	100	340
CMPH-620-4T-0,16	167	3	62	9	155	200	7	10	125	395	100	340
CMPH-820	187	3	82	4,5	180	200	7	10	125	395	100	340
CMPH-922	246,5	3	92	4,5	186	225	9	15	150	480	150	400
CMPH-1025	256,5	3	102	4,5	210	250	9	15	150	480	150	400
CMPH-1128	279,5	3	114	15	239	280	14	20	188	604	150	495
CMPH-1231	293,5	3	128	15	239	315	14	20	188	604	150	495
CMPH-1435	310,5	3	143	17,5	277	355	14	20	188	604	150	495
CMPH-1640	332	5	163	17,5	277	404	14	15	200	630	150	565
CMPH-1845-4T-7,5	353	5	180	23,5	277	454	14	16	236	740	150	673
CMPH-1845-4T-10	353	5	180	23,5	277	454	14	16	236	740	150	673
CMPH-1845-6T-3	347	5	180	17,5	239	454	14	16	236	740	150	673
CMPH-2050	376,5	5	204	23,5	388	500	14	16	236	740	150	673
CMPH-2563-6T-15	425	5	254	22,5	555	630	14	19	284	890	150	813
CMPH-2563-6T-25	443,5	5	254	39,5	555	630	14	19	284	890	150	813

Curvas Características

Ver curvas características serie CMP.

Accesorios



INT

C2V

RM

VSD3/A-RFT
VSD1/A-RFM

AET



HPX

Ventiladores helicoidales tubulares, con motor exterior



Ventiladores helicoidales tubulares, accionados a transmisión, con apertura de envolvente hasta 180°.

Ventilador:

- Envolvente tubular con tapa giratoria. Chapa de acero.
- Hélice en fundición de aluminio.
- Grupo de transmisión estanco (IP66) con sistema de doble retén.
- Dirección aire motor-hélice.
- Temperatura del aire a transportar: -25 °C +120 °C.

Motor:

- Motores con eficiencia IE3 para potencias iguales o superiores a 0,75 kW, excepto monofásicos, 2 velocidades y 8 polos.
- Motores clase F con rodamientos a bolas. Protección IP55.

- Monofásico 230 V 50 Hz y trifásico 230/400 V 50 Hz (hasta 4 kW) y 400/690 V 50 Hz (potencias superiores a 4 kW).

Acabado:

- Anticorrosivo en resina de poliéster polimerizada a 190 °C, previo desengrase con tratamiento nanotecnológico libre de fosfatos.

Bajo demanda:

- Dirección aire hélice-motor.
- Hélice reversibles 100%.
- Bobinados especiales para diferentes tensiones.
- Certificación ATEX Categoría 2 (ver serie HPX/ATEX).

Código de pedido

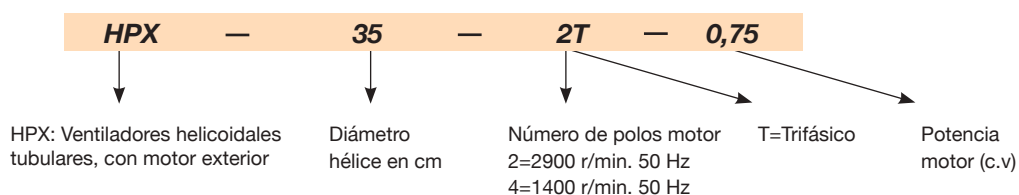

Características técnicas

Modelo	Velocidad (r/min)	Intensidad máxima admisible (A)			Potencia instalada (kW)	Caudal máximo (m³/h)	Nivel presión sonora dB(A)	Peso aprox. (Kg)
		230V	400V	690V				
HPX-35-2T-0.75	2720	2,57	1,49		0,55	4750	77	22
HPX-35-4T-0.33	1420	1,66	0,96		0,25	2500	60	20
HPX-45-4T-0.33	1200	1,66	0,96		0,25	6300	69	32
HPX-45-4T-0.5	1420	2,02	1,17		0,37	6600	70	36
HPX-50-4T-0.75	1310	2,92	1,69		0,55	9000	70	33
HPX-50-4T-1 IE3	1500	2,82	1,62		0,75	10800	71	35
HPX-56-4T-0.75	1380	2,92	1,69		0,55	11300	72	36
HPX-56-4T-1 IE3	1420	2,82	1,62		0,75	12200	73	37
HPX-56-4T-1.5 IE3	1420	4,07	2,34		1,10	14500	75	43
HPX-63-4T-1.5 IE3	1300	4,07	2,34		1,10	16000	74	63
HPX-63-4T-2 IE3	1420	5,41	3,11		1,50	17500	78	71
HPX-71-4T-1.5 IE3	1200	4,07	2,34		1,10	20300	78	78
HPX-71-4T-2 IE3	1350	5,41	3,11		1,50	22500	79	85
HPX-71-4T-3 IE3	1450	7,93	4,56		2,20	24000	81	86
HPX-80-4T-4 IE3	1350	10,70	6,15		3,00	32000	84	105
HPX-80-4T-5.5 IE3	1450	13,90	8,00		4,00	40500	84	108
HPX-90-4T-5.5 IE3	1280	13,90	8,00		4,00	44000	89	120
HPX-90-4T-7.5 IE3	1400		10,30	5,97	5,50	51000	91	155
HPX-100-4T-10 IE3	1450		13,90	8,06	7,50	63000	93	175
HPX-100-4T-15 IE3	1450		20,90	12,10	11,00	68000	94	206

Características acústicas

Los valores indicados, se determinan mediante medidas de nivel de presión y potencia sonora en dB(A) obtenidas en campo libre a una distancia equivalente a dos veces la envergadura del ventilador más el diámetro de la hélice, con un mínimo de 1,5 mts.

Espectro de potencia sonora Lw(A) en dB(A) banda de frecuencia en [Hz]

Modelo	63	125	250	500	1000	2000	4000	8000	Modelo	63	125	250	500	1000	2000	4000	8000
35-2-0,75	48	63	82	81	82	81	76	67	63-4-2	62	73	83	89	90	85	74	70
35-4-0,33	31	46	65	64	65	64	59	50	71-4-1,5	55	75	83	88	90	87	80	69
45-4-0,33	40	55	74	73	74	73	68	59	74-4-2	56	76	84	89	91	88	81	70
45-4-0,50	41	56	75	74	75	74	69	60	71-4-3	65	76	86	92	93	88	77	73
50-4-0,75	44	58	77	77	78	76	72	63	80-4-4	61	81	89	94	96	93	86	75
50-4-1	45	59	78	78	79	77	73	64	80-4-5,5	68	79	89	95	96	91	80	76
56-4-0,75	47	67	75	80	82	79	72	61	90-4-5,5	67	88	95	100	103	99	92	81
56-4-1	48	68	76	81	83	80	73	62	90-4-7,5	69	90	97	102	105	101	94	83
56-4-1,5	57	68	78	84	85	80	69	65	100-4-10	73	93	101	106	108	105	98	87
63-4-1,5	51	71	79	84	86	83	76	65	100-4-15	74	94	102	107	109	106	99	88

Dimensiones mm

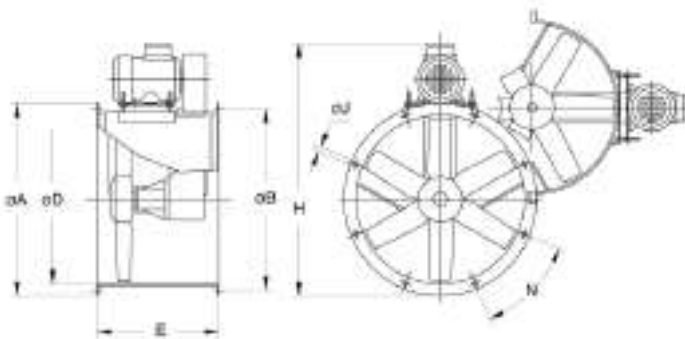

Modelo	ØA	ØB	ØD	E	H	ØJ	N
HPX-35-2T-0,75	425	395	355	380	606	10	8x45°
HPX-35-4T-0,33	425	395	355	380	609	10	8x45°
HPX-45-4T-0,33	540	500	460	420	740	12	8x45°
HPX-45-4T-0,50	540	500	460	420	728	12	8x45°
HPX-50-4T-0,75	600	560	512	420	803	12	12x30°
HPX-50-4T-1	600	560	512	420	803	12	12x30°
HPX-56-4T-0,75	660	620	560	450	848	12	12x30°
HPX-56-4T-1	660	620	560	450	848	12	12x30°
HPX-56-4T-1,5	660	620	560	450	870	12	12x30°
HPX-63-4T-1,5	730	690	640	500	950	12	12x30°
HPX-63-4T-2	730	690	640	500	950	12	12x30°
HPX-71-4T-1,5	810	770	710	550	1017	12	16x22°30'
HPX-71-4T-2	810	770	710	550	1017	12	16x22°30'
HPX-71-4T-3	810	770	710	550	1035	12	16x22°30'
HPX-80-4T-4	900	860	800	600	1173	12	16x22°30'
HPX-80-4T-5,5	900	860	800	600	1200	12	16x22°30'
HPX-90-4T-5,5	1015	970	900	650	1320	15	16x22°30'
HPX-90-4T-7,5	1015	970	900	650	1320	15	16x22°30'
HPX-100-4T-10	1115	1070	1000	750	1483	15	16x22°30'
HPX-100-4T-15	1115	1070	1000	750	1513	15	16x22°30'

Curvas características

Q= Caudal en m³/h, m³/s y cfm.

Pe= Presión estática en mmH₂O, Pa e inwg.

HPX 35...50

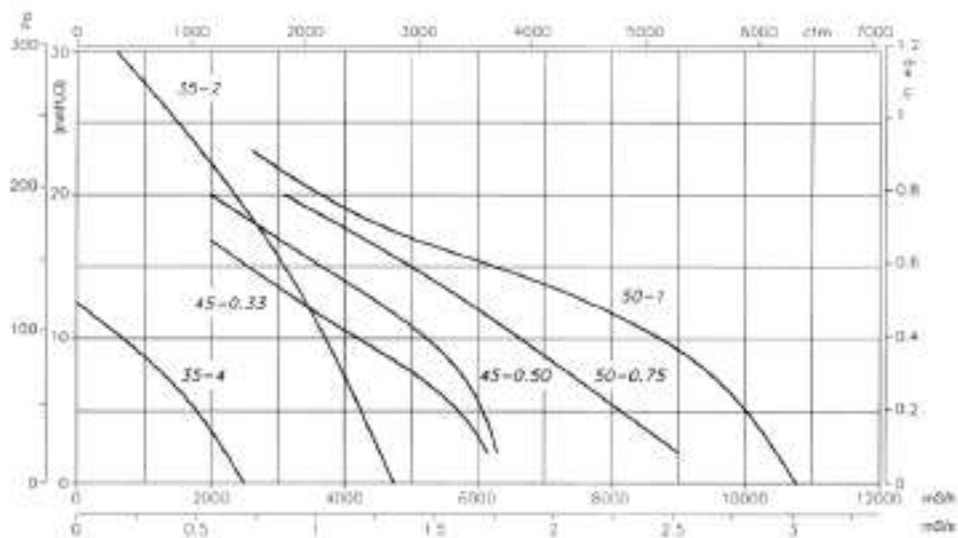

Curvas características

Q= Caudal en m³/h, m³/s y cfm.

Pe= Presión estática en mmH₂O, Pa e inwg.

HPX 56...71

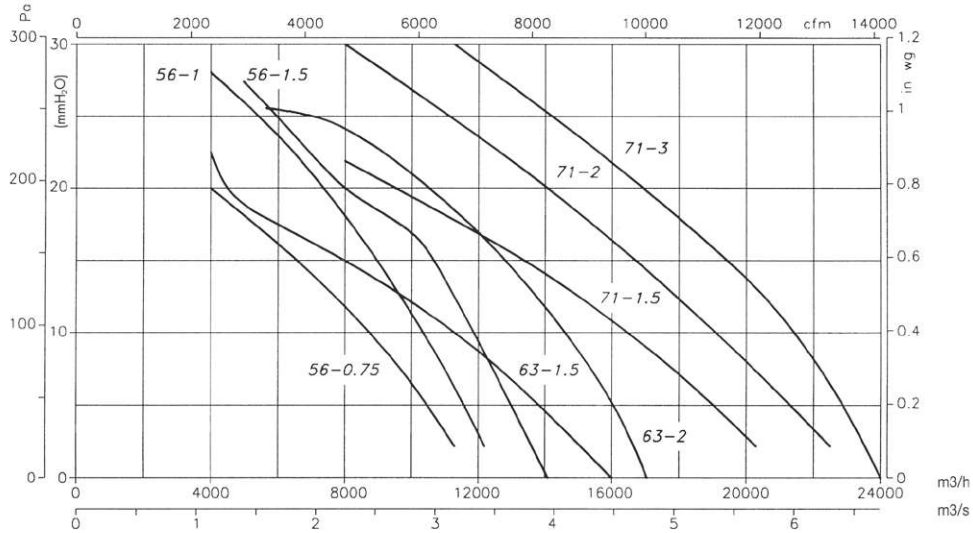

HPX 80...100

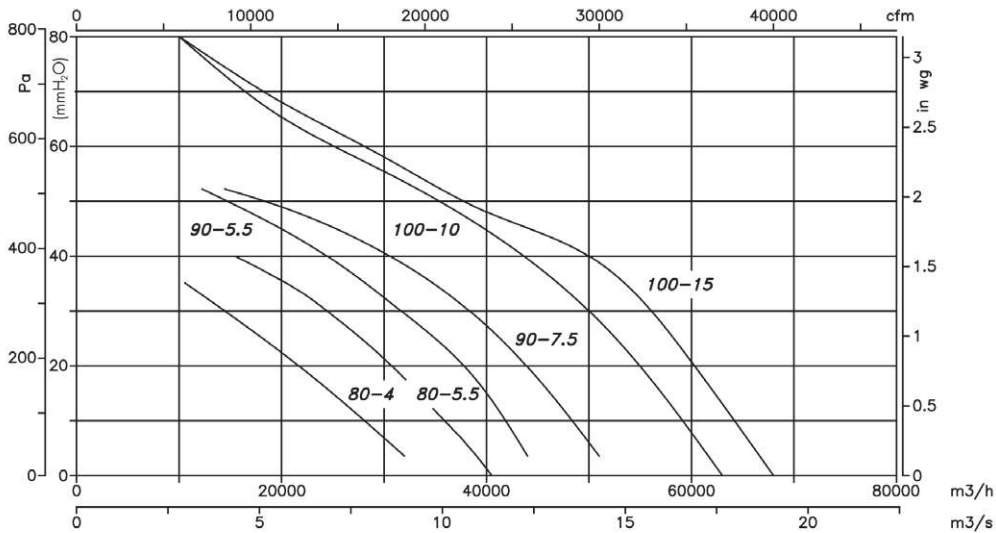

Accesorios



INT

VSD3/A-RFT
VSD1/A-RFM

CUADROS

RT

BTUB

BAC

PS

S

SI

HBA

Ventiladores helicoidales tubulares bifurcados, con motor fuera del flujo de aire



Ventiladores tubulares bifurcados para trasegar aire hasta 150 °C en continuo y hasta 200 °C de forma esporádica.

Ventilador:

- Envoltente tubular en chapa de acero.
- Hélice en fundición de aluminio.
- Dirección aire hélice-motor.

Motor:

- Motores con eficiencia IE3 para potencias iguales o superiores a 0,75 kW, excepto monofásicos, 2 velocidades y 8 polos.
- Motores clase F con rodamientos a bolas. Protección IP55.
- Trifásicos 230/400 V 50 Hz (hasta 4 kW) y 400/690 V 50 Hz (potencias superiores a 4 kW).
- Temperatura de trabajo : -25 °C +150 °C.

Acabado:

- Anticorrosivo en resina de poliéster polimerizada a 190 °C, previo desengrase con tratamiento nanotecnológico libre de fosfatos.

Bajo demanda:

- Envoltente en acero inoxidable.
- Acabado en galvanizado en caliente.
- Bobinados especiales para diferentes tensiones y motores con PTC.

Código de pedido

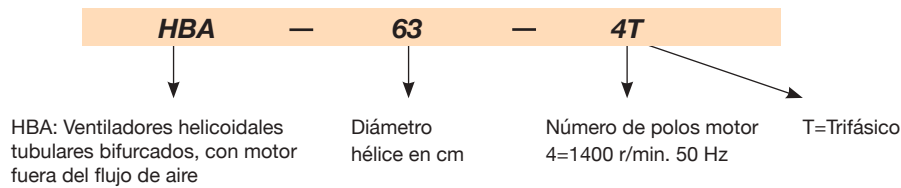

Características técnicas

Modelo	Velocidad (r/min)	Intensidad máx admisible (A)		Potencia instalada (kW)	Caudal máximo (m³/h)	Nivel presión sonora dB(A)	Peso aprox. (Kg)
		230V	400V				
HBA-31-2T	2760	2,57	1,49	0,55	2900	77	25
HBA-31-2M	2810	3,49		0,55	2900	77	26
HBA-31-4T	1350	1,66	0,96	0,25	1600	66	24
HBA-31-4M	1370	2,00		0,25	1600	66	25
HBA-40-2T IE3	2830	4,03	2,34	1,10	6200	82	46
HBA-40-2M	2820	6,51		1,10	6200	82	46
HBA-40-4T	1370	2,02	1,17	0,37	3200	75	40
HBA-45-2T IE3	2910	10,00	5,77	3,00	8550	84	61
HBA-50-4T IE3	1420	2,82	1,62	0,75	6750	76	74
HBA-63-4T IE3	1455	4,07	2,34	1,10	11150	77	95
HBA-71-4T IE3	1450	13,90	8,00	4,00	15850	79	166
HBA-71-6T	900	2,99	1,73	0,55	11200	74	140
HBA-80-6T IE3	945	4,68	2,69	1,10	14900	77	196
HBA-100-6T IE3	945	4,68	2,69	1,10	21700	80	266

Accesorios



Dimensiones mm

HBA-31...50

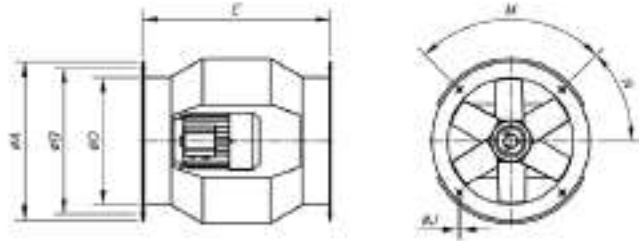

HBA-63...100

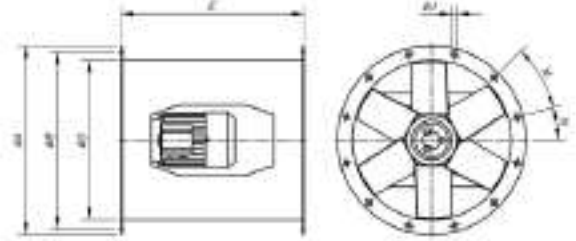

Modelo	ØA	ØB	ØD	E	ØJ	M	N
HBA-31	385	355	308	460	10	4x90°	45°
HBA-40	490	450	410	580	12	8x45°	22'5°
HBA-45	540	500	460	640	12	8x45°	22'5°
HBA-50	600	560	514	730	12	12x30°	15°
HBA-63	730	690	640	730	12	12x30°	15°
HBA-71	810	770	710	770	12	16x22'5°	11'25°
HBA-80	900	860	800	830	12	16x22'5°	11'25°
HBA-100	1115	1070	1000	1270	15	16x22'5°	11'25°

Curvas características

Q= Caudal en m³/h, m³/s y cfm.

Pe= Presión estática en mmH₂O, Pa e inwg.

HBA

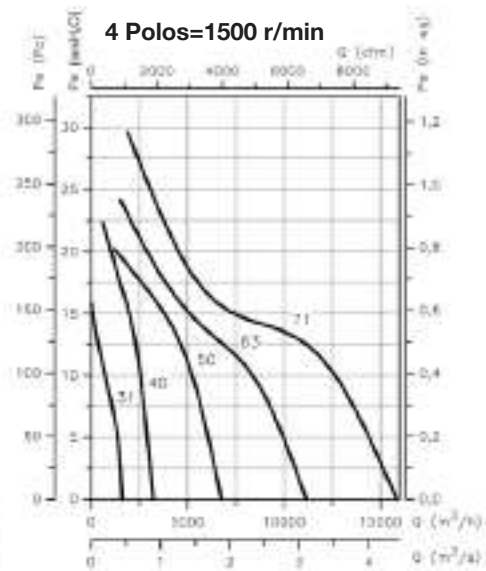
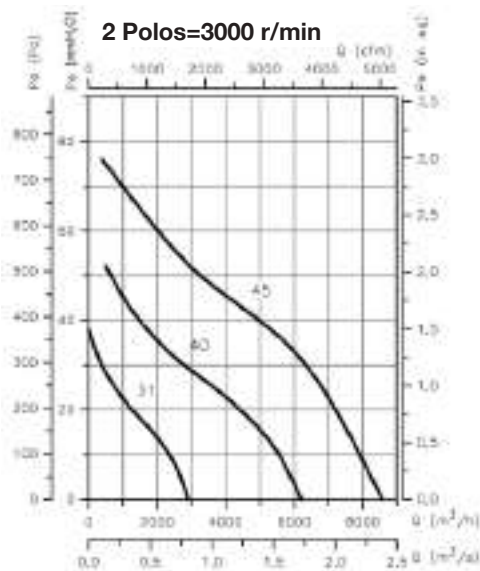

Curvas características

Q= Caudal en m³/h, m³/s y cfm.

Pe= Presión estática en mmH₂O, Pa e inwg.

HBA

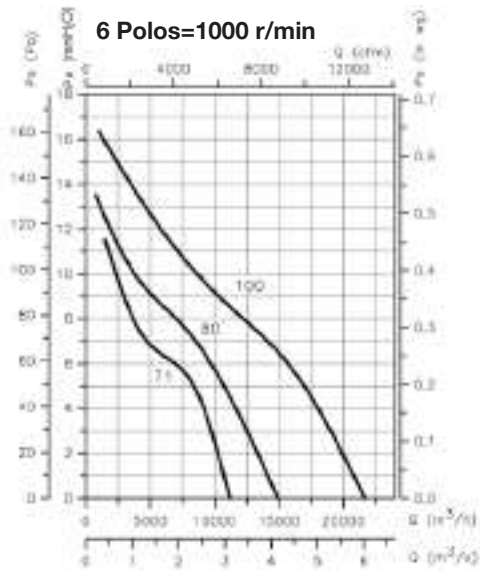



HEADQUARTER

Sodeca, S.L.U.
Pol. Ind. La Barricona
Carrer del Metall, 2
E-17500 Ripoll
Girona, SPAIN
Tel. +34 93 852 91 11
Fax: +34 93 852 90 42
General sales:
comercial@sodeca.com
Export sales:
ventilation@sodeca.com

PRODUCTION PLANT

Sodeca, S.L.U.
Ctra. de Berga, km 0,7
E-08580 Sant Quirze de Besora
Barcelona, SPAIN
Tel. +34 93 852 91 11
Fax: +34 93 852 90 42
General sales:
comercial@sodeca.com
Export sales:
ventilation@sodeca.com



SPAIN - PORTUGAL

OEM & INDUSTRIAL DIVISION

Sodeca, S.L.U.
Mr. Albert Bartés
Pol. Ind. La Barricona
Carrer del Metall, 2
E-17500 Ripoll
Girona, SPAIN
Tel. +34 93 504 16 65
abartes@sodeca.com

EXPORT

OEM & INDUSTRIAL DIVISION

Sodeca, S.L.U.
Mr. Àngel Botello
Pol. Ind. La Barricona
Carrer del Metall, 2
E-17500 Ripoll
Girona, SPAIN
Tel. +34 93 504 16 65
abotello@sodeca.com



EUROPE

FINLAND

Sodeca Finland, Oy
HUITTINEN
Sales and Warehouse
Mr. Kai Yli-Sipilä
Metsälinnankatu 26
FI-32700 Huitinen
Tel. + 358 400 320 125
orders.finland@sodeca.com

HELSINKI
Smoke Control Solutions
Mr. Antti Kontkanen
Viipulantie 9C
FI-00700 Helsinki
Tel. +358 400 237 434
akontkanen@sodeca.com

HYVINKÄÄ
Industrial Applications
Mr. Jaakko Tomperi
Niinistökatu 12
FI-05800 Hyvinkää
Tel. +358 451 651 333
jtomperi@sodeca.com

ITALIA

Marelli Ventilazione, S.R.L.
Viale del Lavoro, 28
37036 San Martino B.A.
(VR), ITALY
Tel. +39 045 87 80 140
vendite@sodeca.com

PORTUGAL

Sodeca Portugal, Unip. Lda.
PORTO
Rua Veloso Salgado 1120/1138
4450-801 Leça de Palmeira
Tel. +351 229 991 100
geral@sodeca.pt

LISBOA
Pq. Emp. da Granja Pav. 29
2625-607 Vialonga
Tel. +351 219 748 491
geral@sodeca.pt

ALGARVE
Rua da Alegria, 33
8200-569 Ferreiras
Tel. +351 289 092 586
geral@sodeca.pt

UNITED KINGDOM

Sodeca Fans UK, Ltd.
Mr. Mark Newcombe
Tamworth Enterprise Centre
Philip Dix House, Corporation
Street, Tamworth, B79 7DN
UNITED KINGDOM
Tel. +44 (0) 1827 216 109
sales@sodeca.co.uk

AMERICA

CHILE

Sodeca Ventiladores, SpA.
Sra. Sofía Ormazábal
Santa Bernardita 12.005
(Esquina con Puerta Sur)
Bodegas 24 a 26,
San Bernardo, Santiago, CHILE
Tel. +56 22 840 5582
ventas.chile@sodeca.com

COLOMBIA

Sodeca Latam, S.A.S.
Sra. Luisa Stella Prieto
Calle7 No. 13 A-44
Manzana 4 Lote1, Montana
Mosquera, Cundinamarca
Bogotá, COLOMBIA
Tel. +57 1 756 4213
ventascolumbia@sodeca.co

PERU

Sodeca Perú, S.A.C.
Sr. Jose Luis Jiménez
C/ Mariscal Jose Luis de
Orbegoso 331. Urb. El pino.
15022, San Luis. Lima, PERÚ
Tel. +51 1 326 24 24
Cel. +51 994671594
comercial@sodeca.pe



HEADQUARTERS
Sodeca, S.L.U.

Pol. Ind. La Barricona
Carrer del Metall, 2
E-17500 Ripoll
Girona, SPAIN
Tel. +34 93 852 91 11
Fax +34 93 852 90 42
General sales: comercial@sodeca.com
Export sales: ventilation@sodeca.com



www.sodeca.com

