

CATÁLOGO GENERAL
2023

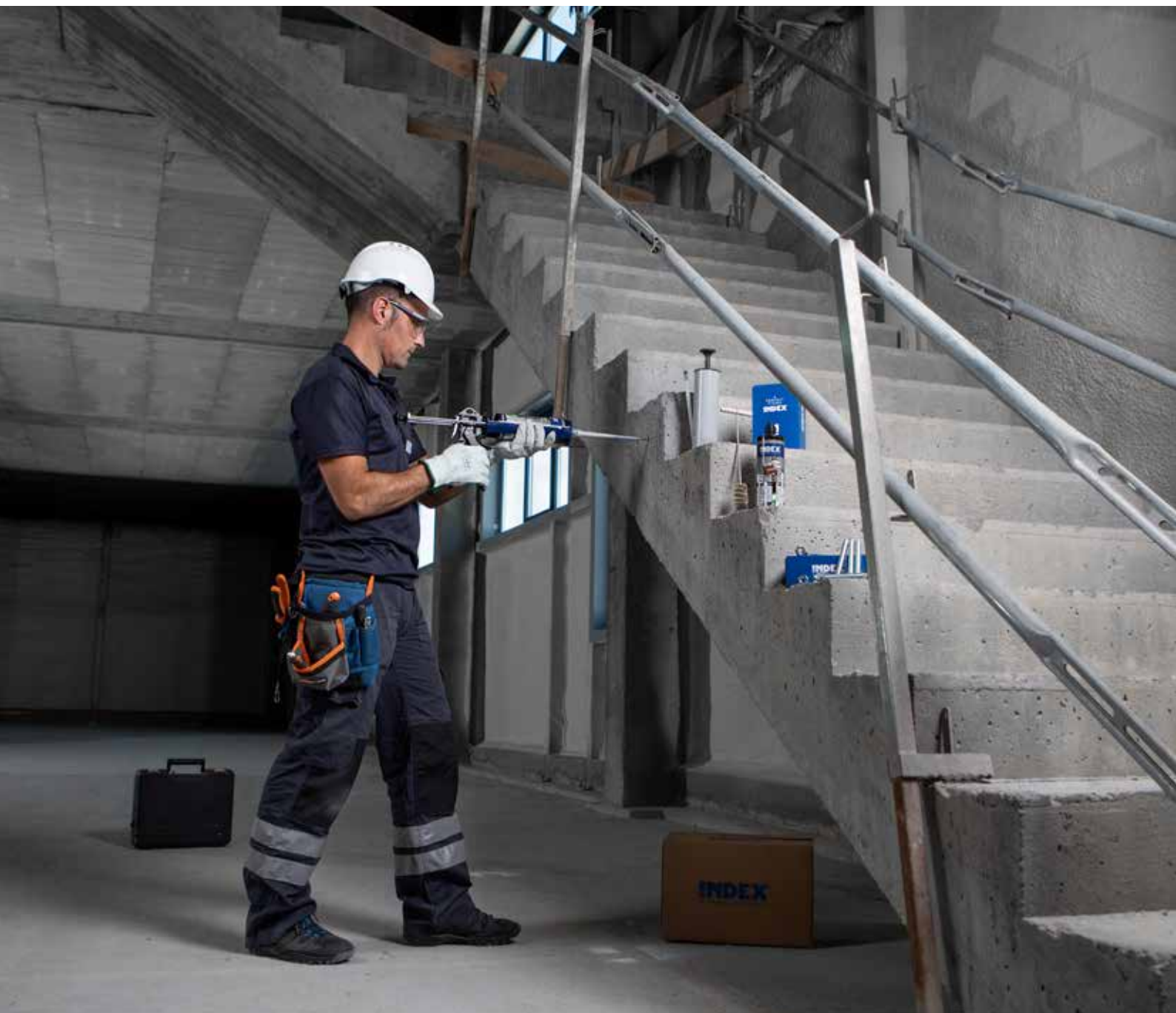

INDEX[®]
A PERFECT FIXING

A
PERFECT
FIXING

CATÁLOGO GENERAL 2023

 02
PRESENTACIÓN

 22
NOVEDADES

 123
ACCESORIOS PARA CABLE
CADENA Y CERCADOS

 221
TORNILLERÍA
NORMALIZADA

 309
SISTEMAS DE INSTALACIÓN
Y FIJACIONES PARA PLACAS
SOLARES

 24
ÍNDICE

 135
FIJACIONES Y ACCESORIOS
PARA PLACA DE YESO

 239
BROCAS, PUNTAS
Y ACCESORIOS

 321
SISTEMAS DE FIJACIÓN
RÁPIDA EN VIGA

 41
FIJACIONES
METÁLICAS

 143
FIJACIÓN
DIRECTA

 245
ABRAZADERAS
METÁLICAS PESADAS

 325
VARILLA ROSCADA Y
ACCESORIOS DE FIJACIÓN

 77
FIJACIONES
QUÍMICAS

 153
TORNILLOS PARA
CUBIERTAS Y FACHADAS

 261
ABRAZADERAS
METÁLICAS LIGERAS

 333
FIJACIÓN SANITARIOS
Y CLIMATIZACIÓN

 93
FIJACIONES
PLÁSTICAS

 163
TORNILLOS BROCA,
ROSCA CHAPA Y PVC

 277
SISTEMAS PROTECCIÓN
CONTRA INCENDIOS

 339
**easy
kits**
EASYKITS

 107
FIJACIONES Y ACCESORIOS
PARA SISTEMAS DE
AISLAMIENTO TÉRMICO (SATE)

 179
TORNILLOS
PARA MADERA

 281
SOPORTES
DE CANALÓN

 345
INOX
GAMA
INOX

 111
FIJACIONES PARA
MATERIALES HUECOS

 201
PUNTAS, ALCAYATAS
Y HEMBRILLAS

 283
ABRAZADERAS
PLÁSTICAS

 375
01
02
03
CARACTERÍSTICAS
TÉCNICAS

 117
REMACHES

 213
CONECTORES
DE MADERA

 297
PERFILERÍA
Y SOPORTACIÓN

 442
ÍNDICE
POR REFERENCIAS

INDEX[®]
A PERFECT FIXING



UNA FIJACIÓN PERFECTA
PARA TU NEGOCIO





En **INDEX®** somos fabricantes y proveedores industriales de sistemas de fijación, ofreciendo soluciones globales adaptadas a las necesidades de tu actividad.

PERO SOMOS MUCHO MÁS QUE ESO. SOMOS UN NUMEROSO EQUIPO HUMANO EN CONTINUA INVESTIGACIÓN, DESARROLLO E INNOVACIÓN Y, POR QUÉ NO DECIRLO, UN POCO OBSESIONADOS CON NUESTRO OBJETIVO: CONSEGUIR UNA FIJACIÓN PERFECTA.

Sea cual sea el tamaño de tu negocio, en **INDEX®** buscaremos una fijación perfecta para el mismo.



**¿POR QUÉ INDEX[®]
ES UNA FIJACIÓN
PERFECTA PARA
TU NEGOCIO?**

En **INDEX**[®] creemos que no hay imposibles cuando se trata de perseguir la perfección. Por eso realizamos continuas inversiones en nuevos productos, homologaciones, procesos productivos y medios tecnológicos para responder a todas las demandas del mercado.

Estas son sólo algunas de las razones por las que
**INDEX[®] MARCA
LA DIFERENCIA**



DISPONIBILIDAD Y AMPLIA GAMA DE PRODUCTO

Más de 10.000 referencias con stock permanente garantizado.



TRABAJAMOS CON EL CANAL

Vendemos a través del canal distribuidor, lo que nos permite conocer el mercado de primera mano.



SOMOS EXPERTOS FABRICANTES

Más de 35 años fabricando sistemas de fijación, nos permite garantizar la máxima calidad en nuestros productos, el mejor servicio y un coste global competitivo.



CALIDAD CERTIFICADA

Contamos con los certificados y homologaciones más importantes, verificando que todos nuestros productos cumplan los más altos estándares de calidad.



PRESENCIA INTERNACIONAL

Somos una empresa global, con ventas en más de 90 países en los 5 continentes y con instalaciones en España, China y México.



SERVICIOS DE INGENIERÍA Y SOPORTE TÉCNICO

Apoyamos a nuestros clientes y a sus clientes en el diseño y cálculo de fijaciones, visitas a obra conjunta y formaciones técnicas sobre temas relacionados con el mundo de la fijación.



SERVICIO DE CALIDAD AL CLIENTE

Nuestros clientes son el centro de todo lo que hacemos. Disponemos de un equipo de más de 300 personas a su servicio.



INDEX SPACE ESTUDIO

Sea cual sea el negocio de nuestros clientes, tenemos una solución expositiva para el mismo.



DISPONIBILIDAD Y AMPLIA GAMA DE PRODUCTO

Somos especialistas en anclajes, tornillos, abrazaderas, sistemas de instalación... Disponemos de la más amplia gama de producto, con más de 10.000 referencias, con un stock permanente garantizado en nuestras instalaciones de España, China y México (más de 45.000m²).



**TENEMOS TODO
LO QUE PUEDES
NECESITAR A NIVEL
DE FIJACIÓN,
APOSTANDO POR
LA INCORPORACIÓN
CONSTANTE DE
NUEVOS PRODUCTOS:
anclajes, tornillos,
abrazaderas, sistemas
de instalación...**





SOMOS EXPERTOS FABRICANTES

Tenemos el control total del proceso productivo, que junto con nuestra experiencia de más de 35 años como fabricantes de sistemas de fijación, nos permite garantizarte la máxima calidad en nuestros productos, el mejor servicio y un coste global competitivo.



**MÁS DE 35 AÑOS
DE EXPERIENCIA**





PRESENCIA INTERNACIONAL

Vendemos en más de 90 países en los 5 continentes y nuestros productos están presentes en los proyectos de construcción más importantes a nivel internacional.





SERVICIO DE CALIDAD AL CLIENTE

Para garantizarte una fijación perfecta, contamos con un equipo de más de 300 personas a tu servicio y unas instalaciones de más de 45.000 m² y 22.000 pallets de capacidad, garantizando un plazo de entrega de 24-48 horas y una respuesta rápida a cualquier tipo de necesidad que puedas tener.



**MÁS DE 300 PERSONAS
A TU SERVICIO**





TRABAJAMOS CON EL CANAL

En **INDEX®**, vendemos a través del canal distribuidor, lo que nos permite estar cerca de nuestros clientes. En este sentido, y para darte el mejor servicio, estamos presente en los canales más importantes, con gamas de productos adecuadas a cada uno de ellos y profesionales altamente cualificados para brindarte el mejor servicio.





CALIDAD CERTIFICADA

Nuestra obsesión por la perfección nos lleva a ampliar continuamente nuestras Certificaciones y Homologaciones de laboratorios independientes y de los principales organismos oficiales, que garantizan la máxima calidad tanto en productos como en sistemas de gestión.

HOMOLOGACIONES



Evaluación Técnica Europea



Conformidad Europea



Homologación Sísmica



ICC-ES®



Resistencia al fuego



Underwriters Laboratories



Homologación FM



Leadership in Energy and Environmental Design



Emisiones VOC reducidas



Water Regulations Advisory Scheme



VdS



Conformidad Reino Unido



PAHs



REACH



RoHS

CERTIFICACIONES



NUESTRO COMPROMISO DE CALIDAD A TRAVÉS DE LA CERTIFICACIÓN TÜV CERT GARANTIZA QUE INDEX® HA IMPLEMENTADO UN SISTEMA DE GESTIÓN SEGÚN LA NORMA ISO 9001:2015



SERVICIOS DE INGENIERÍA Y SOPORTE TÉCNICO

Te ofrecemos un completo asesoramiento técnico a través de un equipo de ingenieros especializados. Disponemos de un servicio S.A.T, software propio especializado y la más completa documentación técnica.

Y lo más importante, un equipo que te apoyará en el diseño, cálculo de fijaciones, visita a obra y formaciones técnicas sobre todo lo relacionado con el mundo de la fijación.

SERVICIO S.A.T. Y ASESORAMIENTO TÉCNICO



FORMACIÓN TÉCNICA



SERVICIOS DE INGENIERÍA Y REALIZACIÓN DE CÁLCULOS

SOFTWARE ESPECIALIZADO



INDEXcal



INDEXwood

Tenemos el software que mejor se adapta a tus necesidades en cada caso concreto.

INDEXcal, software para el cálculo de anclajes.

INDEXwood, software para el cálculo de conexiones de estructuras de madera.

INDEXmor, herramienta online que permite calcular el número de cartuchos químicos necesarios en función de diferentes parámetros.



INDEXmor



AMPLIA DOCUMENTACIÓN
TÉCNICA DISPONIBLE

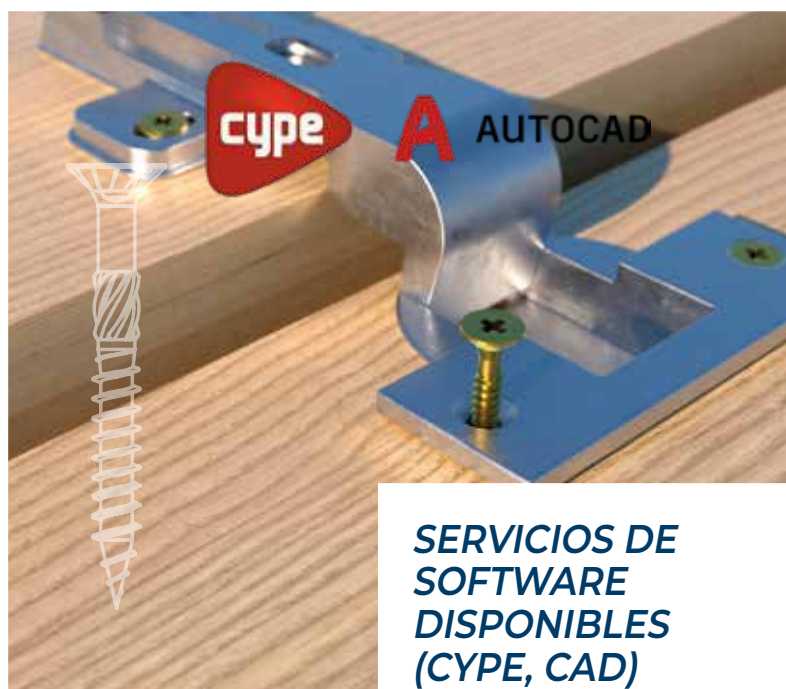

SERVICIOS DE
SOFTWARE
DISPONIBLES
(CYPE, CAD)

INDEX Space Studio es el servicio de INDEX® dedicado al diseño personalizado de expositores y su implantación en los clientes.

Se trata de un servicio único en el mercado, 100% personalizable según las necesidades específicas del cliente (producto, formato de packaging, rotación y/o tipología de negocio), con el objetivo de rentabilizar al máximo el espacio de venta.





VENTAJAS Y CARACTERÍSTICAS

- **PERSONALIZABLE.** Servicio de implantaciones adaptadas a las necesidades de cada negocio.
- **IMPLANTACIONES 100% OPTIMIZADAS.** El sistema está ideado para obtener el máximo aprovechamiento del espacio en el punto de venta.
- **MÚLTIPLES SOLUCIONES.** Contamos con una amplia gama de soluciones expositivas. Góndolas, murales, cabeceras, islas, expositores promocionales...
- **CALIDAD Y SEGURIDAD.** Trabajamos con mobiliario de alta calidad que garantiza una máxima seguridad y una gran robustez de todos los elementos.
- **VERSATILIDAD.** El sistema es compatible con todos los productos y empaquetados de **INDEX®**.
- **OPTIMIZAMOS EL PROCESO DE REPOSICIÓN.** Conocedores de la importancia de facilitar la reposición y mantenimiento del lineal, el mobiliario y los packaging garantizan la máxima ergonomía y practicidad.
- **MÁXIMA VISIBILIDAD DEL PRODUCTO.** Diseñado para mejorar la decisión de compra del cliente final. Dispone de múltiples soluciones visuales de merchandising que complementan y mejoran la implantación.



¿CÓMO FUNCIONA?

INDEX SPACE STUDIO se trabaja en 6 fáciles pasos:

1. ANÁLISIS

El equipo comercial de **INDEX®** analiza junto al cliente las necesidades (espacio disponible, productos a incorporar, tipo de packaging...).

2. DISEÑO

Con la información obtenida, el equipo especializado en implantaciones optimiza y ordena el surtido.

3. PRESENTACIÓN

La presentación de la implantación propuesta está compuesta por una simulación 3D del lineal y un planograma, donde se refleja la colocación exacta del surtido seleccionado.

4. PREPARACIÓN Y EXPEDICIÓN

Para facilitar el montaje de los expositores, las expediciones de nuevas implantaciones se preparan de forma separada del resto de los pedidos habituales.

5. MONTAJE

El equipo especializado de montadores **INDEX®** se ocupa del montaje inicial íntegramente. Instalación del mobiliario, ubicación del producto e instalación de los elementos de merchandising.

6. MANTENIMIENTO Y SEGUIMIENTO

Aseguramos una revisión regular de cada lineal implantado, proponiendo posibles mejoras, manteniéndolo de forma óptima y actualizada y facilitando el trabajo de los reponedores.

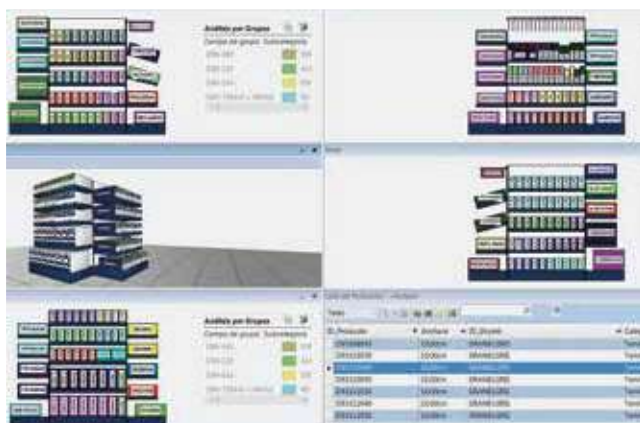



TIPOS DE LINEALES

GÓNDOLA



BALDAS INCLINADAS

Mejora la visualización de todos los productos. Recomendables para formatos de venta en caja ventana y venta INDEXmix.



GAVETAS GRANEL

Disponibles en metal y en plástico reciclado. Ideales para la presentación de productos a granel.



GANCHOS

Disponibles en 30, 40 y 50 cm. Recomendables para la colocación de blísters y productos EASYkits.



BALDAS RECTAS

Indicadas para la presentación de productos pesados como cajas profesionales, botes. Combinadas con separadores es perfecto para productos químicos, siliconas o espumas de poliuretano.

EXPOSITORES PROMOCIONALES Y OTROS



ISLA

Posibles combinaciones.

Medidas por módulo:
100 x 50 x 150 cm (A x F x H)



3 módulos
100 x 150 x 150 cm



4 módulos
100 x 200 x 150 cm



6 módulos
100 x 300 x 150 cm



8 módulos
100 x 400 x 150 cm

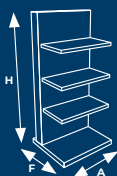

MEDIDAS DISPONIBLES EN STOCK

para expositores góndola/mural, cabeceras e islas:

- A: 100 cm.
- H: 165, 195 y 240 cm.

Otras medidas disponibles **bajo pedido.**

(Plazo de entrega de 4 semanas):

- A: 50, 70, 85 y 130 cm.
- H: 135, 150, 225 y 255 cm.
- F: 50 cm.

TIPOS DE PACKAGING

Conocedores de que cada usuario requiere unas necesidades concretas a nivel de cantidad y embalaje, en INDEX® hemos desarrollado diferentes alternativas para poder satisfacer a cada uno de ellos.

Todos nuestros packaging están fabricados con materiales reciclables y 100% sostenibles y respetuosos con el medioambiente.

Facilitamos la identificación y selección de los productos gracias a la codificación de color en las etiquetas.





CAJA PROFESIONAL

Preparada para los trabajos más exigentes gracias a su cartón reciclado de alta resistencia.



CAJA CON VENTANA

Visual, atractiva. Recomendado para implantar en lineales con autoventa.



BLÍSTER & EASYKits

La mejor solución para cuando el cliente requiere comprar pocas cantidades.



BOTES DE PLÁSTICO

Son la solución perfecta para los grandes instaladores. Facilitan el manipulado en obra y cuentan con un atractivo diseño.



BOLSAS LIBRE SERVICIO

Listas para colocar en el lineal. Cantidades intermedias entre la caja profesional y el blíster.



GRANEL

Disponibles para anclajes, tornillos, abrazaderas y bridas. Una buena solución para implantaciones con espacio de autoventa.



VISUAL MERCHANDISING

En INDEX ponemos a disposición de nuestros distribuidores una amplia gama de soportes para promocionar y comunicar nuestros productos en el punto de venta, como cabeceras de lineales, pósters, tótems, stickers, y ¡mucho más!.



CARTELAS SUPERIORES



CARTELAS PARA GÓNDOLAS BAJAS



ETIQUETEROS PARA BALDAS



STOPPER PARA BALDAS



VINILOS DE SUELO CORPORATIVOS



VINILOS DE SUELO PARA ISLAS



BANNERS PUBLICITARIOS



PÓSTER DE PRODUCTOS



LONAS DE GRAN FORMATO PARA EXTERIORES



BANNERS PUBLICITARIOS



PÓSTER DE PRODUCTOS

AMPLIAMOS GAMA

ACCESORIOS PARA CABLE Y CADENA

	SJ-Z AMPLIACIÓN Sujetacable DIN-741 cincado
	SJ-A4 NEW Sujetacable DIN-741. Inoxidable A4
	SJ-O NEW Sujetacable oval
	SJ-PD NEW Sujetacable plano doble
	SJ-PD A4 NEW Sujetacable plano doble. Inoxidable A4
	SJ-PS NEW Sujetacable plano simple
	SJ-PS A4 NEW Sujetacable plano simple. Inoxidable A4
	TS-GA AMPLIACIÓN Sujetacable DIN-741 cincado
	TS-GA A4 NEW Tensor gancho/anilla DIN-1480. Inoxidable A4
	TS-GG NEW Tensor gancho/gancho. Cincado
	TS-GG A4 NEW Tensor gancho/gancho. Inoxidable A4
	TS-AA NEW Tensor anilla/anilla. Cincado
	TS-AA A4 NEW Tensor anilla/anilla. Inoxidable A4
	TS-VS NEW Tensor varilla soldar

	EV-H AMPLIACIÓN Cáncamo hembra d-582. Cincado
	EV-H A4 NEW Cáncamo hembra d-582. Inoxidable A4
	EV-M AMPLIACIÓN Anilla de elevacion macho DIN-580
	EV-M A4 NEW Anilla de elevacion macho DIN-580. Inoxidable A4
	GR-Z AMPLIACIÓN Grillete recto. Cincado
	GR-A4 NEW Grillete recto. Inoxidable A4
	GS-Z NEW Ese cincada
	GD-Z AMPLIACIÓN Guardacabos DIN-6899/A. Cincado
	GD-A4 NEW Guardacabos DIN-6899/A. Inoxidable A4
	GI-Z NEW Grillete lira cincado
	GI-A4 NEW Grillete lira. Inoxidable A4
	MQ-B NEW Mosqueton bombero
	MQ-BS NEW Mosqueton bombero con seguro

PÁGINA 123

NUEVAS MEDIDAS EN

THE y TFE

Anclaje de fijación directa en hormigón.
Homologado ETE Opt.1. Cabeza hexagonal



PÁGINAS 53 Y 55

HEA y HEA + ARVUL

Tornillo para fijación directa.
Tornillo con cabeza hexagonal



PÁGINA 58

AUTO y AUTO + ARVUL

Tornillo para viga autotaladrante
con cabeza hexagonal



PÁGINA 157

PS3 y PS5

Tornillo autotaladrante de cabeza hexagonal
para panel sándwich



PÁGINA 160

AMPLIAMOS GAMA

SISTEMAS DE INSTALACIÓN Y FIJACIONES PARA PLACAS SOLARES



Grapas y galgas para montaje de placas

NUEVA GALGA 30 mm



Perfiles, uniones, guías y empalmes para estructura de apoyo

NUEVOS PERFILES



Conectores + complementos para montaje de estructuras solares

NUEVAS MEDIDAS



Triángulos para instalación de placas solares



Accesorios regulables para la instalación de placas solares

NUEVAS SOLUCIONES



Accesorios de fijación directa para la instalación de placas solares

NUEVOS TORNILLOS



Accesorios de estanqueidad para la instalación de placas solares



Kits para instalaciones solares

NUEVOS KITS



PÁGINA 309

OTRAS NOVEDADES

MTH-AT

Homologado ETE Opt.7. Eje ATLANTIS C4-M. Clip ATLANTIS C4-M



PÁGINA 47

MTP-AT

Homologado ETE Opt.1. Eje ATLANTIS C4-M. Clip inoxidable A4



PÁGINA 44

TXE

Tornillo hormigón hexagonal con punta Bimetal. Inoxidable A4



PÁGINA 54

HE-HO SDS y HE-HC SDS

Broca SDS con tope para HE-HO y HE-HC



PÁGINA 68

TDR

Tornillo de reparación



PÁGINA 162

ARPARG y ARPARG A2

Arandela paraguas Galvanizada e Inoxidable A2



PÁGINA 161

TN4S-A y TN4S + TP-PO

Taco nylon 4 segmentos. Collarín ancho























































































PÁGINA 102 Y 101

ÍNDICE







Fijaciones metálicas

	MTP		43					HEA + ARVUL	58		
	MTP-A4		43					SL-PT	59		
NEW	MTP-AT		44					SL-PC	59		
	MTP-X		44					CH-TO	61		
	MTP-G		45					CH-A2	61		
	MTH		46					CH-8.8	62		
NEW	MTH-AT		47					CH-8.8 E	62		
	MTH-A2		48					CH-PL	62		
	MTH-A4		48					CH-PI	62		
	MTA		49					CH-INB	63		
	DO-MT		51					CH-INN	63		
	TWA		51					CH-ES	63		
NEW	TP-MT BL		51					CH-GA	64		
NEW	TP-MT NE		51					CH-GE	64		
	THE		53					CH-GF	64		
	THA		53					CH-GF A2	64		
	THP		54					CH-AR	65		
	THT		54					CH-AF	65		
NEW	TXA		54					CH-AF A2	65		
NEW	TXE		54					HE-HO	67		
	TFE		55					HE-A4	67		
	TFN		55					HE-CL	67		
	TFS		56					HE-C4	67		
	TFF		56					HE-HC	68		
	TFM		56					HE-NO	68		
	HP		57				NEW	HE-NS	68		
	HPZ		57				NEW	HE-HO SDS	68		
	HP TP		57					HE-HC SDS	68		
	HR		57					EXP	69		
	HEA		58					EXP-C	69		
								HC	69		











TALA	69			TC-SO 2	76	
TA-ME	70			TC-SO 8	76	
AN-CU 	70			AN-TA	76	
TC-MA	70			Fijaciones químicas		
AC-CA	71			MO-PU 	79	  
AC-CI	71			MO-P+ 	79	  
AC-TO	71			MO-PS+ 	79	  
AC-ES	71			MO-PSP+ 	79	
AC-GA	71			MO-V 	80	  
AC-AR	71			MO-VS 	80	  
ZA-CA	72			MO-H 	80	  
ZA-TO	72			MO-HW 	80	  
ZA-TL	72			MOPURE 	81	  
ZA-PR	72			MOPUR3 	81	  
ZA-ES	72			MOPISTO	82	
ZA-GA	73			MOPISPR	82	
ZA-GF	73			MOPISSI	82	
ZA-AR	73			MOPISPUR6	82	
ZA-AF	73			MOPISNEU	82	
HI-CA	74			MOPISP3	82	
HI-CI	74			MOBOMBA	82	
HI-TO	74			MORCANU	82	
HI-GA	74			MORCAPU	82	
HI-AR	74			MORCEPKIT	82	
EPS	75			NEW MO-TL	82	
TRA	75			NEW MO-PC	82	
AVR	75			MO-TN	82	
AVC	75			MO-ES	82	
AN-23	76			MO-TR	82	
AN-51	76			MO-TM	82	
AN-50 CT	76					

ÍNDICE









CA-QU		83			T-FUX E		96		
EQ-AC		83			T-NUX		96		
EQ-8.8		83			TC-6A		97		
EQ-A2		83			TC-6E		97		
EQ-A4		83			TC-2A		97		
MS-PR		85			TC-SP		98		
MS-TR		85			TC-SP EP		98		
MS-SF		85			TC-A2		98		
SI-PR		87			TC-CC		98		
SI-PRS		87			TC-CA		99		
SI-UNI		87			TC-CA EP		99		
SI-UNS		88			TN4S		100		
SE-ACR		88			TN4S EP		100		
PU-SP		89			TN4S + AL-HA				
PU-SC		89			TN4S + AL-HC				
PU-TP		89			TN4S + AL-RO				
PU-TPR		90			TN4S + DIN-571				
PU-FP		90			TN4S + TP-PO				
PU-FC		90			TN4S + TP-PO EP	NEW	102		
PU-EP		91			TN4S-L		102		
PU-CL		91			NEW TN4S-A		102		
PU-PI		92			NEW TN4S-A EP		102		
PU-PI 2		92			MEDU		102		
PU-CA		92			TACON + AL-HA				
Fijaciones plásticas									
T-NUX A		95			TACON + AL-HC				
T-NUX A A4		95			TACON + AL-RO				
T-NUX E		95			TACON + TP-PO				
T-NUX E A4		96							
T-NUX T		96							

TACON	104	
TACOL	104	
TACOL-A	104	
NEW IPA-CA	105	
IPA-GR	105	
IPA-GN	105	
IPA-AR	105	
IPA-TO	105	
TA-PL	105	

Fijaciones y accesorios para sistemas de aislamiento térmico (SATE)













AIS-C		108	
AIS-S		108	
AIS		108	
AIS-R		108	
AIS-W		109	
AIS-M		109	
AIS-AM		109	
TE		109	

Fijaciones para materiales huecos







BA-ES	112	
BA-GA	112	
CA-BA	112	
PA-ES	113	
PA-GA	113	
CA-PA	113	
IN-CO	114	
IN-HE	114	

IN-SI	114	
INPIN	115	
INPIS	115	
KITINPIN		
ANCLA	116	
TAPLA NY	116	
TAPLA ME	116	
TAPLA ZK	116	





Remaches

RE-NO	118	
RE-IN	119	
RE-CA	119	
RE-BL	119	
RE-NE	120	
RE-FL	120	
TR-AV	121	
TR-CA	121	
TR-CR	121	
RM-MA	122	
RM-PA	122	
RM-EX	122	





Accesorios para cable, cadena y cercados

















SJ-Z	124	
NEW SJ-A4	124	
NEW SJ-O	124	
NEW SJ-PS	125	
NEW SJ-PS A4	125	
NEW SJ-PD	125	

ÍNDICE











NEW	SJ-PD A4	125	
NEW	TS-GA A4	126	
NEW	TS-AA	126	
NEW	TS-GG	127	
NEW	TS-GG A4	127	
NEW	TS-VS	127	
	EV-H	128	
NEW	EV-H A4	128	
	EV-M	128	
NEW	EV-M A4	128	
	GR-Z	129	
NEW	GR-A4	129	
	GD-Z	130	
NEW	GD-A4	130	
NEW	GI-A4	131	
NEW	GS-Z	131	
NEW	MQ-BS	131	
NEW	MQ-B	131	
	CM-BP	132	
	CM-BT	132	
	CM-TA	132	
	CM-TP	132	
	CM-UN	132	
	CM-TENSO	133	
	CM-TENSOVE	133	
	CM-TT	133	

Fijaciones y accesorios para placa de yeso

PL-F	136	
PL-EP	136	
PL-CA	137	
PL-RA	137	



PL-TR	137	
CP-PA	138	
CP-GV	138	
CP-AC	138	
CP-MV	138	
OME	139	
MAB	139	
HO-CU	139	
HO-CR	139	
EMP	140	
CAB	140	
ADU	140	
PCU	140	
SUS	141	
TR-BL	141	
TR-13	141	
TR-15	141	

























Fijación directa

FP08GUN	144	
FP12GUN	144	
FP-IP	144	
FP-CG 08	145	
FP-CL 08	145	
FP-AP 08	145	
FP-C30	145	
FP-AM 08	145	
FP-CR 08 M6	146	
FP-CR 08 M8	146	
FP-PI 08	146	





FP-CG 12	146	
FP-CGD12	146	
FP-CL12	146	
FP-CLD12	147	
FP-CT12	147	
FP-PISCL08	147	
FP-PISPL08	147	
FP-PISCL12	147	
FP-PISCM12	147	
FP-PISCT12	147	
FG-GUN	148	
FG-GUNEL	148	
FG-CL	149	
FG-CLH	149	
OME	149	
FG-ARAM	149	
FG-ARAM EP	149	
FG-PLET	150	
AB-PID	150	
FG-ABRA	150	
FG-CAEL	151	
FG-CLCAR	151	
FG-IMAN	151	
FG-BAT	151	
FG-CAR	151	
FG-GAS	151	

Tornillos para cubiertas y fachadas



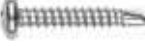



























DIN-7504-K	154	
DIN-7504-K A2	154	
DIN-7504-K + ARVUL	155	

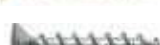





DIN-7504-K CP + ARVUL	155	
DIN-7504-K RE	156	
DIN-7504-K RE + ARVUL	156	
NEW DIN-7504-K RE NI + ARVUL	156	
ABE BIMETAL	157	
ABE BIMETAL + ARVUL	157	
AUTO BIMETAL	158	
AUTO BIMETAL + ARVUL	158	
AUE	158	
AUE + ARVUL	159	
NEW AUE NI + ARVUL	159	
PS 3	159	
PS 3 + ARVUL	159	
PS 3 + ARVUL A2	160	
PS 5	160	
PS 5 + ARVUL	160	
PS 5 + ARVUL A2	160	
FIBR	160	
ARVUL	161	
ARVUL A2	161	
NEW ARPAR	161	
NEW ARPAR A2	161	
ATAP	162	
TDR	162	

NEW Tornillos broca, rosca chapa y pvc











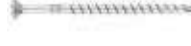
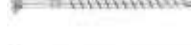



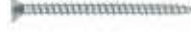



DIN-7504-N HP Z	164	
DIN-7504-N HP A2	165	
DIN-7504-N HP N	165	
DIN-7504-N HP B	165	
DIN-7504-N HT	166	



















































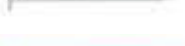







ÍNDICE

DIN-7504-N HC	166	
DIN-7504-P HP Z	167	
DIN-7504-P HP N	168	
DIN-7504-P HT Z	168	
ABA	169	
ATA	169	
RS	169	
RS-A2	169	
BCP Z	170	
BCP A2	170	
BCP N	170	
BCP B	170	
BCP CB	170	
TAEZ	171	
TAEN	171	
DIN-7981 HP B	171	
DIN-7981 HP N	171	
DIN-7981 HP Z	172	
DIN-7982 HP Z	173	
CP-Z	175	
CP-A2	175	
CP-B	175	
CP-N	175	
PVC-10 Z	176	
PVC-20 B	176	
PVC-20 Z	176	
PVC-30	176	
PVC-40 B	176	
PVC-40 Z	177	
PVC-50 B	177	
PVC-50 Z	177	





PVC-70	177	
PVC-70 TP	177	
PVC-90	178	
PVC-VEK	178	
PVC-VEK 13	178	
PVC-VEK 10	178	
PVC-KOM 10	178	

Tornillos para madera

























TEX-BP	180	
TEX-ZP	181	
TEX-ZT	183	
TEX-A2	183	
TEC-BT	185	
TEX-AB	185	
TP-PO B	188	
TP-PO Z	190	
TP-TO	192	
TP-A2	193	
TR-PO	193	
DIN-571	194	
DIN-571 A2	195	
571 TR	195	
INV Z	195	
INV A2	196	
INV N	196	
ESTRINV Z	196	
ESTRINV N	196	
TRE-Z	197	
TRE-PV	197	
FS Z	197	



FS 3009	197		SC-EI	214	
FS 3011	198		SC-ED	214	
FS 5010	198		SC-LD	214	
FS 6005	198		SC-GA	215	
FS 8004	198		SC-RF	215	
FS 8017	198		SC-RG	215	
FS 8019	199		SC-AS	215	
FS 9006	199		SC-CE	215	
FS 9010	199		SC-OB	216	
FS 9011	199		SC-OZ	216	
FIMA	199		SC-CD Z	216	
Puntas, alcayatas y hembrillas			SC-CI	216	
AL-RE	202		SC-EM	216	
AL-PL	202		SC-ER	217	
AL-RO	203		SC-GE Z	217	
AL-RO B	203		SC-MX	217	
AL-HC	204		SC-PD	217	
AL-HC B	204		SC-RE Z	217	
AL-HA	205		SC-LC Z	217	
AL-HA B	205		PT-BR	218	
HC-RM	206		PT-EM	218	
HA-RM	206		PT-ET	218	
PA-CP	207		PT-OB	218	
PA-CC	207		PT-TT	218	
PA-CX			PT-UN	218	
GM-Z	208		AP-AR	219	
CF-B	208		AP-AT	219	
SV-C	209		AP-FL	219	
Conectores para madera			AP-FU Z	219	
SO-UO	214		AP-PD	219	
SO-UR	214		AP-PG	219	

ÍNDICE













AP-PT	220	
AP-UE Z	220	
AP-SB	220	
AP-EN	220	
VM-PF	220	

Tornillería normalizada













DIN-933	222	
DIN-933 A2	224	
DIN-931	225	
DIN-6921	226	
DIN-6921 A2	226	
DIN-912	227	
DIN-603/934	228	
DIN-603 A2	229	
DIN-608	229	
DIN-84	229	
DIN-7985	230	
DIN-963	231	
DIN-965	231	
DIN-934	232	
DIN-934 A2	232	
DIN-985	233	
DIN-985 A2	233	
DIN-6923	234	
DIN-6923 A2	234	
DIN-1587	234	
DIN-125	235	
DIN-125 A2	235	
DIN-9021	236	
DIN-9021 A2	236	
DIN-127	237	















DIN-127 A2	237	
TU-MA	238	
DIN-6798 A	238	

Brocas, puntas y accesorios

B-HDS	240	
PU-PH	240	
PU-TO	240	
PU-OX	241	
PU-PO	241	
PU-CU	241	
BOCA	242	
PU-PM	242	
ATAP	242	
TP-CR B	243	
TP-CR N	243	
TP-TP	243	















Abrazaderas metálicas pesadas

AB-RA	248	
AB-IA	249	
AB-IR	249	
AB-RE	250	
AB-RE V	250	
AB-RE A2	251	
AB-RE A4	251	
AB-RI	252	
AB-RI V	252	
AB-RI A2	253	
AB-RI A4	253	
AB-RI DES	254	
PA-EX	254	
CO-AR	254	



AB-ICP	254	
AB-AIS 13	255	
AB-AIS 19	255	
AB-AIS 30	255	
AB-AIS 40	255	
AB-GA	256	
AB-M8	256	
AB-DE Z	257	
AB-DE G	257	
AB-DP Z	257	
AB-DP G	257	
AB-ZI	258	
AB-ZI A2	258	
AB-SA	259	
AB-GP	259	

Abrazaderas metálicas ligeras





AB-M6	264	
AB-M6 Z	264	
AB-M6 A2	265	
AB-D6	265	
AB-D6 Z	265	
AB-6I	266	
AB-DI	266	
AB-M7 Z	267	
AB-D7 Z	267	
AB-7I Z	268	
AB-7ID Z	268	
AB-PI	269	
AB-PU	269	
AB-IP	270	
AB-SI	270	

AB-TO	270	
AB-SF	271	
AB-SF A2	271	
AB-SF IR	272	
AB-SF IRC	272	
AB-SF IRR	272	
CI-PE	272	
CI-PE A2	272	
AB-CR	273	
AB-ITS	273	
AB-ITD	273	
AB-BU	274	
AB-GM	274	
AB-GS	275	
AB-GD	275	





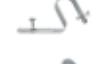



Sistemas de protección contra incendios

AB-PE	278			
AB-CH	278			
AB-CI	 279			
AN-CU	 279			

Soportes para canalones







TE-MO	282	
TE-GA	282	
TE-GR	282	
TE-PE	282	

Abrazaderas plásticas













BN-N	285			
BN-B	286			
BN-GR	287			
BN-VE	287			



















ÍNDICE

BN-MA	287		SP-Z	301	
BN-AM	287		SP-V	301	
BN-AZ	288		SP-H	302	
BN-RO	288		SP-HX	302	
BN-DT	288		TO-GU	302	
TACOBRI G	289		TO-GR	302	
BN-ID	289		TU-GU	302	
BN-PL	289		TU-GRA	303	
BN-BA	290		EG-Z	303	
AB-IN	290		EG-A2	303	
AB-ID	290		PU-Z	303	
AB-GU	291		PG-Z	303	
AB-MUG	291		PG-A2	303	
AB-PR	292		SO-TP	304	
AB-MS	292		GP-X 21	304	
AB-MD	292		GP-X 41	304	
AB-TS	293		SP-X	304	
AB-TD	293		SP-RX	304	
AB-TC	293		SP-UX	305	
FI-CA AB	294		PR-X	305	
FI-CA PS	294		RE-SX	305	
FI-CA PD	294		SO-TP	305	
FI-CA CL	294		TG-X	305	
GR-NY NT	295		TO-GRX	305	
Perfilería y soportación			TU-GX	306	
GP-Z	300		TU-MU	306	
GP-G	300		TU-RX	306	
GP-A2	300		TU-RXA	306	
GP-PL	300		SC-RX	307	
GP-PVC	300		EMP-X	307	
GL-O	301		RT-X	307	





UN-PX	307	
UN-EX	307	
UN-TX	308	
PG-X	308	
AB-GX	308	
UN-CO	308	
SO-PG	308	

Sistemas de instalación y fijaciones para placas solares





KFR-SC	310	
PGS-A	310	
GP-XS	310	
EMP-XS	310	
NEW GP-VD	311	
PSA-A	311	
PSA-UN	311	
PSA-AV	311	
PSE-A	311	
PSE-UN	312	
NEW PSE-C	312	
NEW PSE-CUN	312	
KFS-FI	312	
KFS-FL	312	
TU-RX A2	313	
DIN-603 A2	313	
DIN-6921 A2	313	
DIN-6923 A2	313	
DIN-127 A2	313	
TPA-R	314	
TPA-P	314	
TRP-XS	314	

NU-XS	314	
KFS-MA	315	
KFS-AU	315	
KFS-RV	315	
GS-TC	316	
GS-TU	316	
STR	316	
PMO	316	
NEW PMO-L	316	
NEW MO-TL	317	
NEW MO-PC	317	
TAC + ARVUL	317	
TAC BIMETAL+ARVUL A2	317	
NEW AUE NI + ARVUL	317	
NEW DIN-7504-K RE NI + ARVUL	318	
RE-TE	318	
ARS-P	318	
ARS-S	318	
CS-B	318	





















Sistemas de fijación rápida en viga













SU-CL	322	
SU-VA	322	
SU-CU	323	
SU-AB	323	
SU-CA	323	

Varilla roscada y accesorios de fijación







RV-ZN	326	
RV-ZN 8.8	326	
RV-A2	326	
RV-2M	327	
VR-SE	327	

ÍNDICE

MA-HE	327	
MA-RI	328	
MA-MH	328	
AR-FO	328	
GA-FO	329	
GE-SP	329	
AB-TA	329	
AB-TA B	329	
AB-TA A2	330	
AB-TR	330	
AB-PM7	330	
AB-TG	330	
TM-VR	330	
ES-DR	331	
ES-DA2	331	
AB-FP	331	
AB-FC	332	
PF-ZN	332	
PF-A4	332	
NEW ABE-RM	332	
NEW ABE-BO	332	

SA-LN	336	
SA-LH	336	
SA-IL	336	
SA-WZ	336	
SA-WL	336	
SA-CI	337	
SA-WH	337	
SA-WHM	337	
SA-TE TB	337	
SA-TE AL	337	
CO-SO	338	
CO-KS	338	
EasyKits	339	

Fijación para sanitarios y climatización

RA-TRG	334	
RA-TRI	334	
RA-FRE	334	
RA-FIN	334	
RA-RO	335	
RA-FEM	335	
RA-RAY	335	
RA-PES	335	



Gama Inox





















































	MTP-A4		346			NEW GR-A4	354	
	MTH-A2		346			NEW GD-A4	354	
	MTH-A4		347			NEW GI-A4	355	
	DO-MT		347			DIN-7504-K A2	355	
NEW	TXE		348			ABE BIMETAL	355	
	CH-A2		348			ABE BIMETAL + ARVUL	355	
	CH-PI		348			AUTO BIMETAL	356	
	CH-GF A2		349			AUTO BIMETAL + ARVUL	356	
	CH-AF A2		349			PS 3 + ARVUL A2	356	
	HE-A4		349			PS 5 + ARVUL A2	356	
	HE-C4		349			ARVUL A2	356	
	AC-CI		350			NEW ARPAN A2	357	
	HI-CI		350			DIN-7504-N HP A2	357	
	AVR		350			RS-A2	357	
	AVC		350			BCP A2	357	
	EQ-A2		351			CP-A2	358	
	EQ-A4		351			TEX-A2	358	
	T-NUX A A4		351			TP-A2	358	
	T-NUX E A4		351			DIN-571 A2	359	
	TC-A2		352			INV A2	359	
	RE-IN		352			DIN-933 A2	360	
NEW	SJ-A4		352			DIN-6921 A2	361	
NEW	SJ-PS A4		352			DIN-603 A2	361	
NEW	SJ-PD A4		353			DIN-934 A2	361	
NEW	TS-GA A4		353			DIN-985 A2	362	
NEW	TS-AA A4		353			DIN-6923 A2	362	
NEW	TS-GG A4		353			DIN-125 A2	362	
NEW	EV-H A4		354			DIN-127 A2	363	
NEW	EV-M A4		354					

ICONOGRAFÍA

MATERIALES Y RECUBRIMIENTOS DE PRODUCTO

 Inoxidable A2	 Inoxidable A4	 Inoxidable AISI 430	 Bimetal	 Atlantis C4-M
 Atlantis C3-H	 Atlantis C3-M	 Atlantis C3-L	 Atlantis C2-H	 Atlantis C2-M
 Atlantis C2-L	 Bicromatado	 Cincado	 Cincado negro	 Cincado blanco
 Fosfatado	 Galvanizado azul	 Zamak	 Latón	 Cobre
 Pavonado	 Aluminio	 Polietileno	 Nylon	 PVC
 Plastificado negro	 Plastificado blanco	 Plastificado amarillo	 Polipropileno	 Butileno
 EPDM				

MATERIALES DE USO

 Carpintería aluminio	 Carpintería PVC	 Canalón	 Viga IPN	 Tubo ventilación
 Cartón yeso	 Cable	 Cadena	 Cuerda	 Tubo cromado
 Chapa - perfil pesado	 Ensamblaje Chapa	 Chapa - madera	 Fibrocemento	 Tubo butano
 Madera - metal	 Escayola	 Hormigón armado	 Hormigón fisurado	 Tubo fundición
 Hormigón	 Hormigón hueco	 Ladrillo macizo	 Tubo cobre	 Tubo gas
 Termoarcilla	 Piedra	 Ladrillo de adobe	 Tubo pvc	 Cable
 Madera noble	 Madera pino	 Hormigón celular	 Tubo plástico	 Tubo PPR
 Madera fina	 Panel de madera	 Ladrillo hueco	 Tubo inoxidable	 Tubo acero
 Placa alveolar	 Teja	 Instalación perfiles de aluminio	 Tubo incendios	 Tubo flexible
 SATE alta densidad	 SATE baja densidad	 Cerámico	 Azulejo	 Porcelanato
 Aluminio	 Vidrio	 Bloque de ladrillo		

HUELLAS

















 Hexagonal	 Cuadrada	 Hexagonal con ranura	 Hexagonal con arandela estampada	 PH
 Ranura	 Allen	 TX	 PZ	

CARGAS









 Cargas ligeras	 Cargas medias	 Cargas altas	 Cargas muy altas
---	---	--	--

PROTECCIÓN FRENTE A LA CORROSIÓN

CATEGORÍAS DE CORROSIÓN

CATEGORÍAS DE CORROSIÓN	NIVEL DE CORROSIÓN	AMBIENTES TÍPICOS: EJEMPLOS DE ISO9223		RECUBRIMIENTOS DISPONIBLES INDEX®
		INTERIOR	EXTERIOR	
C1	MUY BAJO	Espacios calefactados con baja humedad relativa y contaminación insignificante, por ejemplo, oficinas, escuelas, museos.	Zona seca o fría, ambiente atmosférico con muy baja contaminación y tiempo de humedad, por ejemplo, ciertos desiertos, ártico central/antártico.	 CINCADO  CINCADO NEGRO  CINCADO BLANCO  FOSFATADO  PLASTIFICADOS
C2	BAJO	Espacios sin calefacción con temperatura variable y humedad relativa. Baja frecuencia de condensación y baja contaminación, por ejemplo, almacenamiento, pabellones deportivos.	Zona templada, ambiente atmosférico con baja contaminación (SO ₂ : <5 g/m ³), por ejemplo, zonas rurales, pequeñas ciudades. Zona seca o fría, ambiente atmosférico con poco tiempo de humedad, por ejemplo desiertos, zonas subárticas.	 ATLANTIS C2-H  ATLANTIS C2-M  ATLANTIS C2-L  BICROMATADO  GALVANIZADO ORGÁNICO AZUL
C3	MEDIO	Espacios con frecuencia moderada de condensación y contaminación moderada por el proceso de producción, por ejemplo, plantas de procesamiento de alimentos, lavanderías, cervecerías, lecherías.	Zona templada, ambiente atmosférico con contaminación media (SO ₂ : 5µ g/m ³ a 30µ g/m ³) o algún efecto de cloruros, por ejemplo, zonas urbanas, zonas costeras con baja deposición de cloruros. Zona tropical y subtropical, atmósfera con baja contaminación.	 ATLANTIS C3-H  ATLANTIS C3-M  ATLANTIS C3-L  INOXIDABLE AISI 430
C4	ALTO	Espacios con alta frecuencia de condensación y alta contaminación por proceso de producción, por ejemplo, plantas de procesamiento industrial.	Zona templada, ambiente atmosférico con alta contaminación (SO ₂ : 30 g/m ³ a 90 g/m ³) o efecto sustancial de cloruros, por ejemplo, zonas urbanas contaminadas, zonas industriales, zonas costeras sin pulverización de agua salada (1-10 km) o exposición a fuertes efectos de salinidad. Zona subtropical y tropical, atmósfera con contaminación media.	 ATLANTIS C4-M  INOXIDABLE A2 (AISI 304)
C5	MUY ALTO	Espacios con muy alta frecuencia de condensación y/o con alta contaminación por proceso de producción, por ejemplo, minas, cavernas con fines industriales, espacios sin ventilación en zonas subtropicales y tropicales.	Zona templada y subtropical, ambiente atmosférico con contaminación muy alta (SO ₂ : 90 g/m ³ a 250 g/m ³) y/o efecto significativo de cloruros, por ejemplo, zonas industriales, zonas costeras (0-1 km), instalaciones protegidas en la costa.	 INOXIDABLE A4 (AISI 316)

GUÍA RÁPIDA DE SELECCIÓN

		CATEGORÍAS DE CORROSIÓN				
		C1	C2	C3	C4	C5
CONDICIONES MEDIOAMBIENTALES Y/O ATMOSFÉRICAS	 INTERIORES SIN CONDENSACIÓN	✓				
	 INTERIORES CON CONDENSACIÓN TEMPORAL		✓			
	 EXTERIORES EN ZONAS RURALES CON MUY BAJA CONTAMINACIÓN		✓			
	 EXTERIORES CON BAJA CONTAMINACIÓN			✓		
	 EXTERIORES CON CONCENTRACIÓN MODERADA DE CONTAMINACIÓN				✓	
	 ÁREAS COSTERAS					✓
	 EXTERIORES CON FUERTE CONTAMINACIÓN INDUSTRIAL					✓
	 ZONAS CERCANAS A CARRETERAS					✓

* La selección indicada en la tabla es para exposiciones esperadas de 25 años y siempre que cumplan con un mantenimiento adecuado.

* En el caso de instalaciones con productos homologados, el uso en esos ambientes no está cubierto por la Aprobación Técnica Europea (ETA) de anclajes, donde se establece que solo los anclajes de acero inoxidable se pueden instalar en exteriores y garantizando una vida útil del anclaje de 50 años.



FIJACIONES METÁLICAS

A
PERFECT
FIXING
INDEX

Los anclajes macho son una solución profesional y efectiva para la instalación de elementos con garantías de alto rendimiento en hormigón fisurado y no fisurado.

Disponibles en una amplia gama que incluye, entre otros, anclajes con homologación europea ETA 12/0397 para uso en hormigón fisurado y no fisurado, así como homologación sísmica C1&C2 y para resistencia a fuego, y homologación europea ETA 05/0242 para uso en hormigón no fisurado. Aptos para su instalación en aplicaciones interiores como exteriores gracias a las opciones de recubrimientos (ATLANTIS C3-L y cincado) y materiales disponibles (inoxidable A2, inoxidable A4 y acero).



DISEÑO Y GEOMETRÍA



Rebaje del eje como protección de la rosca durante la instalación del anclaje.



Tuerca. La rosca interna permite acoplar el tornillo, facilitando la sujeción y la unión de elementos desmontables. Se suministra premontada.



Arandela. Asegura una óptima presión del elemento a instalar. Se suministra con arandela DIN 125 premontada. Opcionalmente se puede suministrar con arandelas DIN 9021 (serie ancha) o DIN 440 (para madera).



La letra del eje indica la longitud del mismo, permitiendo conocer la longitud del anclaje una vez instalado. Es importante comprobar el espesor a fijar para elegir adecuadamente la longitud del anclaje necesaria.



Marca de profundidad de instalación. La línea pintada en el eje, establece la profundidad recomendada por la homologación para introducir el anclaje en el taladro.



Borde del eje. Permite que el clip se mantenga en su posición durante la instalación.



Clip de expansión y cono. El cono se retrae, expandiendo el clip, ejerciendo presión sobre el material base que permite la fijación.



Identificación. Modelo y medida del mismo indicado en la clip.

APLICACIONES



- Aplicaciones estructurales
- Vigas y pilares estructurales
- Asientos en estadios
- Estructuras de madera a hormigón
- Barandillas y vallados
- Estanterías y racks
- Vigas y pilares estructurales
- Fijación de elementos no estructurales como carteles, maquinaria, calderas, señales, vallas publicitarias, etc.
- Otras instalaciones

CUALIDADES Y VENTAJAS



MÁXIMA VERSATILIDAD. PROFUNDIDAD DE ANCLAJE VARIABLE.

Permite la instalación hasta dos profundidades de atornillado distintas en M8, M10, M12, M16* y M20*

* En la versión MTH cincado

MÁXIMAS GARANTÍAS. PRODUCTOS HOMOLOGADOS ACORDE A LOS MÁS ALTOS ESTÁNDARES DE CALIDAD.

- Homologación ETA 12/0397 en opción 1 para la instalación en hormigón fisurado y no fisurado (C20/25-C50/60).
- Homologación ETA 05/0242 en opción 7 para la instalación en no fisurado (C20/25-C50/60).
- Homologación sísmica C1&C2.
- Homologado a resistencia a fuego R30-R120 en hormigón.
- Confirmada idoneidad para la instalación de sistemas de rociadores según la norma Vds CEA 4001.



FABRICACIÓN 100% INDEX

Esto nos permite asegurar un riguroso control de los procesos, garantizar la máxima calidad en nuestros productos, brindar el mejor servicio y obtener un coste global competitivo.

GAMA



PRODUCTO	MTP	MTP-A4	MTP-X	MTP-AT	MTP-G	MTH	MTH-AT	MTH-A4	MTH-A2	MTA
EJE	Zinc	A4 Inox	Zinc	Atlantis	Atlantis	Zinc	Atlantis	A4 Inox	A2 Inox	Zinc
CLIP	A4 Inox	A4 Inox	Atlantis	A4 Inox	A4 Inox	Zinc	Atlantis	A4 Inox	A2 Inox	Zinc
CE	✓	✓	✓	✓	✓		✓			
CE						✓		✓	✓	
REMP	✓		✓							
REMP	✓	✓	✓	✓	✓	✓	✓	✓	✓	
REMP	✓	✓	✓	✓	✓					

EL RECUBRIMIENTO PERFECTO SEGÚN EL NIVEL DE CORROSIÓN



Recubrimiento Atlantis C3-L: válido para condiciones interiores secas (50 años) o en ambientes exteriores tipo C3 según la norma ISO 9223, por un periodo de 25 años.



Recubrimiento Cincado: apto para uso en condiciones interiores secas (categoría C1 según la norma ISO 9223), por un periodo de 50 años.



Material Inoxidable A4: válido para interior y exterior, en zonas costeras o industriales, zonas expuestas a alta contaminación o zonas cercanas a carreteras.



Material Inoxidable A2: válido para espacios interiores con alta frecuencia de condensación o ambientes exteriores que no estén situados próximos a zonas costeras o de elevada contaminación.

Anclaje macho para cargas altas en hormigón fisurado y no fisurado

MTP



MACIZOS



CÓDIGO	HOMOLOGACIÓN SÍSMICA	MEDIDA	€/100	ESPESOR MÁX. A FIJAR	LETRA EJE (LONGITUD)		
• AP08050	-	M8 x 50 Ø8	76,247	2	A	100	800
AP08075	-	M8 x 75 Ø8	80,757	9	C	100	600
AP08095	-	M8 x 95 Ø8	85,163	29	E	100	600
AP08115	-	M8 x 115 Ø8	104,493	49	G	100	400
AP10090	C1	M10 x 90 Ø10	110,423	10	E	100	400
AP10105	C1	M10 x 105 Ø10	131,043	25	F	50	300
AP10115	C1	M10 x 115 Ø10	138,663	35	G	50	200
AP10135	C1	M10 x 135 Ø10	159,360	55	H	50	200
AP10165	C1	M10 x 165 Ø10	191,760	85	K	50	200
AP10185	C1	M10 x 185 Ø10	203,147	105	L	50	150
• AP12080	-	M12 x 80 Ø12	157,947	4	D	50	300
AP12100	C1 & C2	M12 x 100 Ø12	173,260	4	E	50	200
AP12110	C1 & C2	M12 x 110 Ø12	169,120	14	F	50	200
AP12120	C1 & C2	M12 x 120 Ø12	206,543	24	G	50	200
AP12130	C1 & C2	M12 x 130 Ø12	213,803	34	H	50	200
AP12150	C1 & C2	M12 x 150 Ø12	252,443	54	I	50	100
AP12180	C1 & C2	M12 x 180 Ø12	301,127	84	L	50	150
AP12200	C1 & C2	M12 x 200 Ø12	352,310	104	M	50	150
AP16145	C1 & C2	M16 x 145 Ø16	391,073	28	I	25	100
AP16175	C1 & C2	M16 x 175 Ø16	505,017	58	K	25	50
AP16220	C1 & C2	M16 x 220 Ø16	592,913	103	O	25	50
AP16250	C1 & C2	M16 x 250 Ø16	768,907	133	Q	25	50
AP20170	-	M20 x 170 Ø20	763,093	32	K	20	40
AP20200	-	M20 x 200 Ø20	907,383	62	N	20	40
AP24205	-	M24 x 205 Ø24	1.756,023	35	N	10	30
AP24235	-	M24 x 235 Ø24	1.943,203	65	P	10	20

• Medidas sin homologar
• Medida sin homologar para fuego

Homologado ETE Opt.1. Eje zincado. Clip inoxidable



Disponible con arandela DIN 9021. Consultar precio y plazo

Útil de colocación



INOXIDABLE



CÓDIGO	MEDIDA	€/100	ESPESOR MÁX. A FIJAR	LETRA EJE (LONGITUD)		
APA408075	M8 x 75 Ø8	317,357	9	C	100	600
APA408095	M8 x 95 Ø8	393,693	29	E	100	600
APA408115	M8 x 115 Ø8	445,824	49	G	100	400
APA408135	M8 x 135 Ø8	515,787	69	H	50	300
APA410090	M10 x 90 Ø10	529,971	10	E	100	400
APA410105	M10 x 105 Ø10	566,727	25	F	50	300
APA410115	M10 x 115 Ø10	624,312	35	G	50	300
APA410135	M10 x 135 Ø10	748,929	55	H	50	300
APA410165	M10 x 165 Ø10	893,658	85	K	50	100
APA410185	M10 x 185 Ø10	956,418	105	L	50	100
APA412110	M12 x 110 Ø12	769,476	14	F	50	200
APA412120	M12 x 120 Ø12	825,519	24	G	50	200
APA412130	M12 x 130 Ø12	896,412	34	H	50	200
APA412150	M12 x 150 Ø12	1.047,555	54	I	50	100
APA412180	M12 x 180 Ø12	1.221,933	84	L	50	150
APA412200	M12 x 200 Ø12	1.247,603	104	M	50	100
APA416125	M16 x 125 Ø16	1.704,563	8	G	50	100
APA416145	M16 x 145 Ø16	1.967,780	28	I	25	100
APA416175	M16 x 175 Ø16	2.577,187	58	K	25	50
APA416190	M16 x 190 Ø16	2.668,900	73	L	25	50
APA416220	M16 x 220 Ø16	2.842,630	103	O	20	40
APA420200	M20 x 200 Ø20	4.386,093	62	M	20	40
APA420240	M20 x 240 Ø20	5.034,167	102	P	15	30
APA420285	M20 x 285 Ø20	5.922,157	147	S	10	20

MTP-A4

Homologado ETE Opt.1. Eje Inoxidable A4. Clip inoxidable A4



Útil de colocación

MTP

Anclaje macho para cargas altas en hormigón fisurado y no fisurado

NEW MTP-AT

Homologado ETE Opt.1. Eje ATLANTIS C4-M. Clip inoxidable



Útil de colocación

MACIZOS

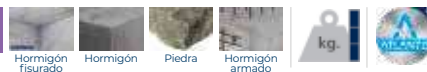

CÓDIGO	HOMOLOGACIÓN SÍSMICA	MEDIDA	€/100	ESPESOR MÁX. A FIJAR LETRA EJE (LONGITUD)			
APAT08075	-	M8 x 75 Ø8	121,137	9	C	100	600
APAT08095	-	M8 x 95 Ø8	127,747	29	E	100	600
APAT08115	-	M8 x 115 Ø8	156,743	49	G	100	400
APAT10090	C1	M10 x 90 Ø10	171,153	10	E	100	400
APAT10105	C1	M10 x 105 Ø10	203,120	25	F	50	300
APAT10115	C1	M10 x 115 Ø10	214,930	35	G	50	200
APAT10135	C1	M10 x 135 Ø10	254,973	55	H	50	200
APAT10165	C1	M10 x 165 Ø10	297,230	85	K	50	200
APAT10185	C1	M10 x 185 Ø10	314,880	105	L	50	150
APAT12100	C1	M12 x 100 Ø12	252,720	4	E	50	200
APAT12110	C1	M12 x 110 Ø12	285,880	14	F	50	200
APAT12120	C1	M12 x 120 Ø12	287,503	24	G	50	200
APAT12130	C1	M12 x 130 Ø12	330,467	34	H	50	200
APAT12150	C1	M12 x 150 Ø12	378,663	54	I	50	100
APAT12180	C1	M12 x 180 Ø12	451,693	84	L	50	150
APAT12200	C1	M12 x 200 Ø12	528,467	104	M	50	150
APAT16145	C1	M16 x 145 Ø16	598,927	28	I	25	100
APAT16175	C1	M16 x 175 Ø16	625,720	58	K	25	50
APAT16220	C1	M16 x 220 Ø16	858,530	103	O	25	50
APAT20170	-	M20 x 170 Ø20	1.037,603	32	K	20	40
APAT20200	-	M20 x 200 Ø20	1.361,077	62	N	20	40

MTP-X

Homologado ETE Opt.1. Eje zincado. Clip ATLANTIS C3-L



Disponible con arandela DIN 9021. Consultar precio y plazo

Útil de colocación

MACIZOS



02 Info. Técnica P. 378

CÓDIGO	HOMOLOGACIÓN SÍSMICA	MEDIDA	€/100	ESPESOR MÁX. A FIJAR LETRA EJE (LONGITUD)			
• APX08050	-	M8 x 50 Ø8	65,313	2	A	100	800
APX08075	C1	M8 x 75 Ø8	69,160	9	C	100	600
APX08080	C1	M8 x 80 Ø8	71,230	14	D	100	600
APX08095	C1	M8 x 95 Ø8	74,953	29	E	100	600
APX08115	C1	M8 x 115 Ø8	91,993	49	G	100	400
APX10090	C1 & C2	M10 x 90 Ø10	97,200	10	E	100	400
APX10105	C1 & C2	M10 x 105 Ø10	110,133	25	F	50	300
APX10115	C1 & C2	M10 x 115 Ø10	115,547	35	G	50	200
APX10135	C1 & C2	M10 x 135 Ø10	143,953	55	H	50	200
APX10165	C1 & C2	M10 x 165 Ø10	168,067	85	K	50	200
APX10185	C1 & C2	M10 x 185 Ø10	185,593	105	L	50	150
• APX12080	-	M12 x 80 Ø12	131,340	4	D	50	300
APX12100	C1 & C2	M12 x 100 Ø12	144,847	4	E	50	200
APX12110	C1 & C2	M12 x 110 Ø12	148,120	14	F	50	200
APX12120	C1 & C2	M12 x 120 Ø12	185,593	24	G	50	200
APX12130	C1 & C2	M12 x 130 Ø12	193,917	34	H	50	200
APX12150	C1 & C2	M12 x 150 Ø12	211,763	54	I	50	100
APX12180	C1 & C2	M12 x 180 Ø12	265,303	84	L	50	150
APX12200	C1 & C2	M12 x 200 Ø12	309,320	104	M	50	150
APX12220	C1 & C2	M12 x 220 Ø12	324,787	124	O	25	50
APX12255	C1 & C2	M12 x 255 Ø12	357,267	159	R	25	50
APX16145	C1	M16 x 145 Ø16	375,943	28	I	25	100
APX16175	C1	M16 x 175 Ø16	440,183	58	K	25	50
APX16220	C1	M16 x 220 Ø16	517,520	103	O	25	50
APX16250	C1	M16 x 250 Ø16	666,230	133	Q	25	50
APX20170	C1 & C2	M20 x 170 Ø20	672,177	32	K	20	40
APX20200	C1 & C2	M20 x 200 Ø20	767,350	62	M	20	40

• Medidas sin homologar
• Medida sin homologar para fuego

Anclaje macho para cargas altas en hormigón fisurado y no fisurado

MTP

02 Info Técnica
P. 378

MACIZOS



MTP-G

Homologado ETE Opt.1. Eje ATLANTIS C3-L. Clip inoxidable A4



Útil de colocación

CÓDIGO	HOMOLOGACIÓN SÍSMICA	MEDIDA	€/100	ESPESOR MÁX. A FIJAR LETRA EJE (LONGITUD)			
• APG06060	-	M6 x 60 Ø6	59,810	10	B	200	1.200
• APG06070	-	M6 x 70 Ø6	61,647	20	C	200	1.200
• APG06100	-	M6 x 100 Ø6	67,620	50	E	200	800
• APG08050	-	M8 x 50 Ø8	79,013	2	A	100	800
• APG08060	-	M8 x 60 Ø8	79,728	12	B	100	800
APG08075	C1	M8 x 75 Ø8	92,853	9	C	100	600
APG08095	C1	M8 x 95 Ø8	100,373	29	E	100	600
APG08115	C1	M8 x 115 Ø8	116,063	49	G	100	400
• APG10070	-	M10 x 70 Ø10	121,390	5	C	100	400
APG10090	C1	M10 x 90 Ø10	139,840	10	E	100	400
APG10105	C1	M10 x 105 Ø10	151,117	25	F	50	300
APG10115	C1	M10 x 115 Ø10	158,853	35	G	50	200
APG10135	C1	M10 x 135 Ø10	174,693	55	H	50	200
APG10165	C1	M10 x 165 Ø10	214,670	85	K	50	200
APG10185	C1	M10 x 185 Ø10	232,120	105	L	50	150
• APG12080	-	M12 x 80 Ø12	210,870	4	D	50	300
APG12110	C1 & C2	M12 x 110 Ø12	242,810	14	F	50	200
APG12130	C1 & C2	M12 x 130 Ø12	287,953	34	H	50	200
APG12150	C1 & C2	M12 x 150 Ø12	307,913	54	I	50	100
APG12180	C1 & C2	M12 x 180 Ø12	339,106	84	L	50	150
APG12200	C1 & C2	M12 x 200 Ø12	342,054	104	M	50	150
APG16125	C1 & C2	M16 x 125 Ø16	470,163	8	G	25	100
APG16145	C1 & C2	M16 x 145 Ø16	497,243	28	I	25	100
APG16175	C1 & C2	M16 x 175 Ø16	546,783	58	K	25	50
APG16220	C1 & C2	M16 x 220 Ø16	679,900	103	O	25	50
APG20170	C1 & C2	M20 x 170 Ø20	845,617	32	K	20	40
APG20200	C1 & C2	M20 x 200 Ø20	853,733	62	M	20	40

- Medidas sin homologar
- Medida sin homologar para fuego



MÁS INFORMACIÓN DISPONIBLE
EN NUESTRA NUEVA PÁGINA WEB
WWW.INDEXFIX.COM

MTH

Anclaje macho para cargas altas en hormigón no fisurado

MTH

Homologado ETE Opt.7. Eje cincado.
Clip cincado



Disponible con arandela DIN 9021.
Consultar precio y plazo



Útil de colocación



MACIZOS

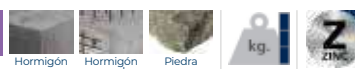

CÓDIGO	MEDIDA	€/100	ESPESOR MÁX. A FIJAR	LETRA EJE (LONGITUD)		
AH06060	M6 x 60 Ø6	42,111	2	B	200	1.200
AH06070	M6 x 70 Ø6	43,718	12	C	200	1.200
AH06080	M6 x 80 Ø6	45,316	22	D	200	1.200
AH06090	M6 x 90 Ø6	46,699	32	E	200	1.200
AH06100	M6 x 100 Ø6	48,647	42	E	200	800
AH06110	M6 x 110 Ø6	60,857	52	F	200	800
AH06120	M6 x 120 Ø6	63,893	62	G	100	600
AH06130	M6 x 130 Ø6	72,269	72	H	100	600
AH06140	M6 x 140 Ø6	72,785	82	I	100	400
AH06150	M6 x 150 Ø6	78,074	92	I	100	400
AH06160	M6 x 160 Ø6	82,287	102	J	100	400
AH06170	M6 x 170 Ø6	93,303	112	K	100	400
AH06180	M6 x 180 Ø6	102,510	122	L	100	200
AH08060	M8 x 60 Ø8	50,990	3	B	100	600
AH08075	M8 x 75 Ø8	53,225	5	C	100	600
AH08090	M8 x 90 Ø8	57,699	20	E	100	600
AH08100	M8 x 100 Ø8	61,565	30	E	100	400
AH08115	M8 x 115 Ø8	73,170	45	G	100	400
AH08120	M8 x 120 Ø8	80,073	50	G	100	400
AH08130	M8 x 130 Ø8	86,364	60	H	100	400
AH08155	M8 x 155 Ø8	125,430	85	J	100	200
AH10070	M10 x 70 Ø10	67,407	3	C	100	400
AH10080	M10 x 80 Ø10	77,083	13	D	100	400
AH10090	M10 x 90 Ø10	80,370	10	E	100	400
AH10100	M10 x 100 Ø10	92,670	20	E	100	400
AH10120	M10 x 120 Ø10	97,233	40	G	50	300
AH10140	M10 x 140 Ø10	117,718	60	H	50	200
AH10150	M10 x 150 Ø10	123,637	70	I	50	200
AH10160	M10 x 160 Ø10	145,789	80	J	50	200
AH10170	M10 x 170 Ø10	159,451	90	K	50	200
AH10210	M10 x 210 Ø10	196,681	130	N	50	150
AH10230	M10 x 230 Ø10	208,619	150	P	50	100
AH12090	M12 x 90 Ø12	112,982	13	E	50	200
AH12100	M12 x 100 Ø12	122,118	8	E	50	200
AH12110	M12 x 110 Ø12	126,341	18	F	50	200
AH12120	M12 x 120 Ø12	149,940	28	G	50	200
AH12130	M12 x 130 Ø12	154,833	38	H	50	200
AH12140	M12 x 140 Ø12	155,188	48	H	50	200
AH12160	M12 x 160 Ø12	184,128	68	J	50	100
AH12180	M12 x 180 Ø12	216,883	88	L	50	150
AH12200	M12 x 200 Ø12	258,900	108	M	50	100
AH12220	M12 x 220 Ø12	274,873	128	O	50	100
AH12250	M12 x 250 Ø12	329,557	158	Q	25	50
AH14120	M14 x 120 Ø14	257,090	12	G	25	100
AH14145	M14 x 145 Ø14	301,893	37	I	25	100
AH14170	M14 x 170 Ø14	322,527	62	K	25	100
AH14220	M14 x 220 Ø14	447,210	112	O	25	75
AH14250	M14 x 250 Ø14	499,530	142	Q	25	50
AH16125	M16 x 125 Ø16	268,940	3	G	25	100
AH16145	M16 x 145 Ø16	289,807	23	I	25	100
AH16170	M16 x 170 Ø16	358,387	48	K	25	50
AH16220	M16 x 220 Ø16	427,063	98	O	25	50
AH16250	M16 x 250 Ø16	553,797	128	Q	25	50
AH16280	M16 x 280 Ø16	602,857	158	S	25	50
AH20170	M20 x 170 Ø20	529,270	23	K	20	40
AH20220	M20 x 220 Ø20	659,013	73	O	20	40
AH20270	M20 x 270 Ø20	900,647	123	S	20	40

• Medida sin homologar para fuego

Bolsa autoservicio

CÓDIGO	MEDIDA	€/BOLSA	PCS	BOLSAS
LSAH06060	M6 x 60 Ø6	11,976	30	6
LSAH08060	M8 x 60 Ø8	9,831	20	6
LSAH08075	M8 x 75 Ø8	8,791	16	6
LSAH08090	M8 x 90 Ø8	8,319	14	6
LSAH10070	M10 x 70 Ø10	7,584	10	5
LSAH10090	M10 x 90 Ø10	6,818	8	6
LSAH10120	M10 x 120 Ø10	6,354	6	6
LSAH12090	M12 x 90 Ø12	7,797	6	5
LSAH12110	M12 x 110 Ø12	8,142	6	5
LSAH16125	M16 x 125 Ø16	5,829	2	6

Anclaje macho para cargas altas en hormigón no fisurado

MTH



MTH-AT **NEW**

Homologado ETE Opt.7. Eje ATLANTIS C4-M. Clip ATLANTIS C4-M

CÓDIGO	MEDIDA	€/100	ESPESOR MÁX. A FIJAR	LETRA EJE (LONGITUD)		
• AHAT06060	M6 x 60 Ø6	70,037	2	B	200	1.200
• AHAT06080	M6 x 80 Ø6	75,363	22	D	200	1.200
• AHAT06100	M6 x 100 Ø6	83,280	42	E	200	800
AHAT08060	M8 x 60 Ø8	89,237	3	B	100	600
AHAT08075	M8 x 75 Ø8	97,983	5	C	100	600
AHAT08090	M8 x 90 Ø8	109,167	20	E	100	600
AHAT08115	M8 x 115 Ø8	135,367	45	G	100	400
AHAT08130	M8 x 130 Ø8	144,707	60	H	100	400
AHAT08155	M8 x 155 Ø8	213,230	85	J	100	200
AHAT10070	M10 x 70 Ø10	141,557	3	C	100	400
AHAT10080	M10 x 80 Ø10	169,580	13	D	100	400
AHAT10090	M10 x 90 Ø10	176,813	10	E	100	400
AHAT10100	M10 x 100 Ø10	194,607	20	E	100	400
AHAT10120	M10 x 120 Ø10	218,777	40	G	50	300
AHAT10140	M10 x 140 Ø10	252,827	60	H	50	200
AHAT10150	M10 x 150 Ø10	265,540	70	I	50	200
AHAT10160	M10 x 160 Ø10	285,240	80	J	50	200
AHAT10170	M10 x 170 Ø10	304,170	90	K	50	200
AHAT10210	M10 x 210 Ø10	365,567	130	N	50	150
AHAT12090	M12 x 90 Ø12	254,210	13	E	50	200
AHAT12100	M12 x 100 Ø12	274,763	8	E	50	200
AHAT12110	M12 x 110 Ø12	284,267	18	F	50	200
AHAT12130	M12 x 130 Ø12	348,377	38	H	50	200
AHAT12140	M12 x 140 Ø12	333,303	48	H	50	200
AHAT12160	M12 x 160 Ø12	395,457	68	J	50	100
AHAT12180	M12 x 180 Ø12	455,450	88	L	50	150
AHAT12200	M12 x 200 Ø12	531,870	108	M	50	100
AHAT12220	M12 x 220 Ø12	563,487	128	O	50	100
AHAT12250	M12 x 250 Ø12	626,157	158	Q	25	50
AHAT16125	M16 x 125 Ø16	564,777	3	G	25	100
AHAT16145	M16 x 145 Ø16	637,577	23	I	25	100
AHAT16170	M16 x 170 Ø16	770,530	48	K	25	50
AHAT16220	M16 x 220 Ø16	960,890	98	O	25	50
AHAT16250	M16 x 250 Ø16	1.079,903	128	Q	25	50
AHAT16280	M16 x 280 Ø16	1.175,567	158	S	25	50
AHAT20170	M20 x 170 Ø20	1.190,857	23	K	20	40
AHAT20220	M20 x 220 Ø20	1.515,730	73	O	20	40
AHAT20270	M20 x 270 Ø20	1.756,257	123	S	20	40

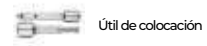
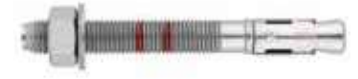

• Medida sin homologar para fuego

MTH

Anclaje macho para cargas altas en hormigón no fisurado

MTH-A2

Homologado ETE Opt.7. Eje Inoxidable A2. Clip Inoxidable A2

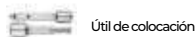

INOXIDABLE

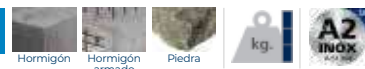

CÓDIGO	MEDIDA	€/100	ESPESOR MÁX. A FIJAR	LETRA EJE (LONGITUD)		
• M106045	M6 x 45 Ø6	134,462	1	A	200	1.200
• M106060	M6 x 60 Ø6	150,793	2	B	200	1.200
• M106080	M6 x 80 Ø6	157,720	22	D	200	1.200
• M106120	M6 x 120 Ø6	194,797	62	G	100	600
• M106140	M6 x 140 Ø6	246,545	82	I	100	600
• M106160	M6 x 160 Ø6	267,436	102	J	100	400
• M106170	M6 x 170 Ø6	281,594	112	K	100	400
• M106180	M6 x 180 Ø6	325,706	122	L	100	300
• M108050	M8 x 50 Ø8	160,163	4	A	100	800
M108075	M8 x 75 Ø8	175,434	5	C	100	600
M108090	M8 x 90 Ø8	199,642	20	E	100	600
M108115	M8 x 115 Ø8	258,250	45	G	100	400
M110070	M10 x 70 Ø10	271,445	3	C	100	400
M110090	M10 x 90 Ø10	303,850	10	E	100	400
M110120	M10 x 120 Ø10	356,142	40	G	50	300
M110150	M10 x 150 Ø10	507,688	70	I	50	200
• M112075	M12 x 75 Ø12	411,593	5	C	50	300
M112090	M12 x 90 Ø12	427,093	13	D	50	200
M112110	M12 x 110 Ø12	470,653	18	F	50	200
M112140	M12 x 140 Ø12	589,905	48	I	50	200
• M116090	M16 x 90 Ø16	1.136,670	4	D	25	150
M116145	M16 x 145 Ø16	1.392,705	23	I	25	100
M116170	M16 x 170 Ø16	1.576,915	48	K	25	75
• M120120	M20 x 120 Ø20	1.807,833	5	G	20	40
• M120170	M20 x 170 Ø20	2.444,499	23	K	20	40
M120220	M20 x 220 Ø20	3.062,988	73	O	20	40

• Medidas sin homologar
• Medida sin homologar para fuego



CÓDIGO	MEDIDA	€/BOLSA	PCS BOLSA	BOLSAS
BZMI08075	M8 x 75 Ø8	4,463	2	12
BZMI10090	M10 x 90 Ø10	4,463	2	10



CÓDIGO	MEDIDA	€/CAJA	PCS CAJA	CAJAS
VM108075	M8 x 75 Ø8	24,555	10	8
VM108090	M8 x 90 Ø8	26,254	10	8
VM110070	M10 x 70 Ø10	27,130	8	8
VM110090	M10 x 90 Ø10	30,368	8	8
VM110120	M10 x 120 Ø10	26,695	6	8
VM112110	M12 x 110 Ø12	33,120	6	8



CÓDIGO	MEDIDA	€/BOLSA	PCS BOLSA	BOLSAS
LSMI08075	M8 x 75 Ø8	24,919	12	7
LSMI08090	M8 x 90 Ø8	28,358	12	7
LSMI10070	M10 x 70 Ø10	30,524	10	6
LSMI10090	M10 x 90 Ø10	30,368	8	6
LSMI10120	M10 x 120 Ø10	32,036	8	6
LSMI12110	M12 x 110 Ø12	33,120	6	6

MTH-A4

Homologado ETE Opt.7. Eje Inoxidable A4. Clip Inoxidable A4



Disponible con arandela DIN 9021. Consultar precio y plazo

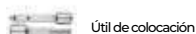

INOXIDABLE



CÓDIGO	MEDIDA	€/100	ESPESOR MÁX. A FIJAR	LETRA EJE (LONGITUD)		
• MIA406045	M6 x 45 Ø6	154,056	1	A	200	1.200
• MIA406060	M6 x 60 Ø6	167,836	2	B	200	1.200
• MIA406080	M6 x 80 Ø6	187,692	22	D	200	1.200
• MIA408050	M8 x 50 Ø8	197,184	4	A	100	800
MIA408075	M8 x 75 Ø8	218,704	5	C	100	600
MIA408090	M8 x 90 Ø8	238,853	20	E	100	600
MIA408115	M8 x 115 Ø8	300,139	45	G	100	400
MIA410070	M10 x 70 Ø10	342,939	3	C	100	400
MIA410090	M10 x 90 Ø10	388,704	10	E	100	400
MIA410120	M10 x 120 Ø10	472,506	40	G	50	300
MIA410150	M10 x 150 Ø10	691,956	70	I	50	200
• MIA412075	M12 x 75 Ø12	524,237	5	C	50	300
MIA412090	M12 x 90 Ø12	557,010	13	D	50	200
MIA412110	M12 x 110 Ø12	627,733	18	F	50	200
MIA412140	M12 x 140 Ø12	752,747	48	I	50	200
• MIA416090	M16 x 90 Ø16	1.391,103	4	D	25	150
MIA416145	M16 x 145 Ø16	1.827,627	23	I	25	100
MIA416170	M16 x 170 Ø16	2.110,490	48	K	25	75
• MIA420120	M20 x 120 Ø20	2.453,313	5	G	20	40
MIA420170	M20 x 170 Ø20	3.353,590	23	K	20	40
MIA420220	M20 x 220 Ø20	4.174,890	73	O	20	40

• Medidas sin homologar
• Medida sin homologar para fuego



CÓDIGO	MEDIDA	€/CAJA	PCS CAJA	CAJAS
VMIA408075	M8 x 75 Ø8	28,783	10	8
VMIA410090	M10 x 90 Ø10	39,392	8	8
VMIA412110	M12 x 110 Ø12	45,068	6	8



CÓDIGO	MEDIDA	€/BOLSA	PCS BOLSA	BOLSAS
LSMIA408075	M8 x 75 Ø8	31,763	12	7
LSMIA410090	M10 x 90 Ø10	41,465	8	7
LSMIA412110	M12 x 110 Ø12	45,139	6	5

Anclaje macho para cargas altas

MTA

Info
Técnica
P. 381

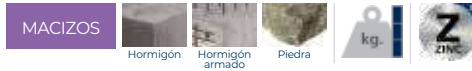

CÓDIGO	MEDIDA	€/100	ESPESOR MÁX. A FIJAR		
AM06045	M6 x 45 Ø6	32,928	1	200	1.200
AM06055	M6 x 55 Ø6	35,742	11	200	1.200
AM06060	M6 x 60 Ø6	35,413	2	200	1.200
AM06065	M6 x 65 Ø6	35,845	7	200	1.200
AM06070	M6 x 70 Ø6	36,773	12	200	1.200
AM06080	M6 x 80 Ø6	37,769	22	200	1.200
AM06085	M6 x 85 Ø6	39,380	27	200	1.200
AM06090	M6 x 90 Ø6	39,837	32	200	1.200
AM06100	M6 x 100 Ø6	42,394	42	200	800
AM06110	M6 x 110 Ø6	45,286	52	200	800
AM06120	M6 x 120 Ø6	46,743	62	100	600
AM06130	M6 x 130 Ø6	46,909	72	100	600
AM06140	M6 x 140 Ø6	60,737	82	100	600
AM06150	M6 x 150 Ø6	69,558	92	100	600
AM06160	M6 x 160 Ø6	72,826	102	100	400
AM06170	M6 x 170 Ø6	89,532	112	100	400
AM06180	M6 x 180 Ø6	94,843	122	100	300
AM08050	M8 x 50 Ø8	43,018	4	100	800
AM08060	M8 x 60 Ø8	42,804	3	100	800
AM08065	M8 x 65 Ø8	44,628	8	100	600
AM08075	M8 x 75 Ø8	45,483	5	100	600
AM08090	M8 x 90 Ø8	48,432	20	100	600
AM08115	M8 x 115 Ø8	61,285	45	100	400
AM08120	M8 x 120 Ø8	62,460	50	100	400
AM08130	M8 x 130 Ø8	71,866	60	100	400
AM08155	M8 x 155 Ø8	121,699	85	100	200
AM10065	M10 x 65 Ø10	67,730	1	100	400
AM10070	M10 x 70 Ø10	61,714	3	100	400
AM10080	M10 x 80 Ø10	64,434	13	100	400
AM10090	M10 x 90 Ø10	69,479	10	100	400
AM10100	M10 x 100 Ø10	75,933	20	100	400
AM10120	M10 x 120 Ø10	82,463	40	50	300
AM10140	M10 x 140 Ø10	93,593	60	50	200
AM10150	M10 x 150 Ø10	105,286	70	50	200
AM10160	M10 x 160 Ø10	128,813	80	50	200

CÓDIGO	MEDIDA	€/100	ESPESOR MÁX. A FIJAR		
AM10170	M10 x 170 Ø10	134,730	90	50	200
AM10210	M10 x 210 Ø10	186,678	130	50	150
AM10230	M10 x 230 Ø10	211,600	150	50	100
AM12075	M12 x 75 Ø12	99,298	5	50	300
AM12080	M12 x 80 Ø12	97,951	3	50	300
AM12090	M12 x 90 Ø12	103,325	13	50	200
AM12100	M12 x 100 Ø12	103,052	8	50	200
AM12110	M12 x 110 Ø12	106,110	18	50	200
AM12120	M12 x 120 Ø12	120,909	28	50	200
AM12140	M12 x 140 Ø12	135,047	48	50	200
AM12160	M12 x 160 Ø12	163,726	68	50	100
AM12180	M12 x 180 Ø12	187,116	88	50	150
AM12220	M12 x 220 Ø12	245,487	128	50	100
AM12250	M12 x 250 Ø12	298,179	158	25	50
AM14080	M14 x 80 Ø14	176,576	5	50	200
AM14100	M14 x 100 Ø14	202,689	5	50	100
AM14120	M14 x 120 Ø14	227,311	12	25	100
AM14145	M14 x 145 Ø14	271,632	37	25	100
AM14170	M14 x 170 Ø14	295,483	62	25	100
AM14220	M14 x 220 Ø14	393,973	112	25	75
AM14250	M14 x 250 Ø14	432,250	142	25	50
AM16090	M16 x 90 Ø16	219,606	4	25	150
AM16110	M16 x 110 Ø16	222,003	7	25	100
AM16125	M16 x 125 Ø16	224,773	3	25	100
AM16145	M16 x 145 Ø16	241,007	23	25	100
AM16170	M16 x 170 Ø16	304,359	48	25	50
AM16220	M16 x 220 Ø16	369,257	98	25	50
AM16250	M16 x 250 Ø16	484,080	128	25	50
AM16280	M16 x 280 Ø16	526,934	158	25	50
AM20120	M20 x 120 Ø20	390,624	5	20	40
AM20170	M20 x 170 Ø20	458,651	23	20	40
AM20220	M20 x 220 Ø20	582,703	73	20	40
AM20270	M20 x 270 Ø20	780,469	123	20	40
AM24180	M24 x 180 Ø24	1.329,341	10	10	20
AM24260	M24 x 260 Ø24	1.830,122	80	10	20



Disponibles con arandela DIN 9021. Consultar precio y plazo



Util de colocación

Blíster

CÓDIGO	MEDIDA	€/BOLSA	PCS B	BOLSAS
BZAM06060	M6 x 60 Ø6	3,216	2	20
BZAM06080	M6 x 80 Ø6	3,216	2	20
BZAM08050	M8 x 50 Ø8	3,216	2	15
BZAM08075	M8 x 75 Ø8	3,216	2	15
BZAM08090	M8 x 90 Ø8	3,216	2	15
BZAM10070	M10 x 70 Ø10	3,216	2	12
BZAM10090	M10 x 90 Ø10	3,216	2	12
BZAM10120	M10 x 120 Ø10	3,216	2	12
BZAM12090	M12 x 90 Ø12	3,216	2	10
BZAM12110	M12 x 110 Ø12	3,216	2	10
BZAM12140	M12 x 140 Ø12	3,216	2	10

Caja ventana

CÓDIGO	MEDIDA	€/CAJA	PCS	CAJAS
VAM06060	M6 x 60 Ø6	8,318	20	8
VAM08075	M8 x 75 Ø8	6,959	12	8
VAM08090	M8 x 90 Ø8	7,398	12	8
VAM10070	M10 x 70 Ø10	4,666	6	8
VAM10090	M10 x 90 Ø10	5,172	6	8
VAM10120	M10 x 120 Ø10	6,147	6	8
VAM12090	M12 x 90 Ø12	7,542	6	8
VAM12110	M12 x 110 Ø12	7,882	6	8



INDEXcal V4

SOFTWARE DE CÁLCULO DE ANCLAJES

El programa de cálculo de anclajes INDEXcal es la herramienta adecuada para que los diseñadores de soluciones estructurales cumplan con los requisitos del Eurocódigo 2, parte 4. Comprueba de forma rápida y detallada todos los anclajes de nuestro catálogo en base a parámetros de entrada del usuario, indicando su adecuación o no a las mismas.

Prestaciones:

- Válido para hormigón fisurado y no fisurado de distintas resistencias.
 - Cálculo para condiciones de fuego y/o sísmico.
- Indica la razón de rechazo de aquellos anclajes que no cumplan los requisitos estructurales.
- Personalización de placas de anclajes, incluyendo rectangulares, circulares, hexagonales, octogonales e irregulares.
 - Permite incluir en el diseño perfiles normalizados o personalizados.
 - Opción filtrado anclajes.
- Multilingüe: disponible en castellano, inglés, francés, alemán y holandés.
- Acceso directo a fichas técnicas y homologaciones desde el propio software.
 - Informe completo en pdf, personalizable.
 - Actualizable on-line.
 - Interface usuario 3D.
- Disponible para un uso gratuito, pudiéndose descargar en la página web.
- Permite incluir cálculo con varias hipótesis de cargas de forma simultánea.

CALIDAD CERTIFICADA

Nuestra obsesión por la perfección lleva a ampliar continuamente nuestras certificaciones y homologaciones de laboratorios independientes y de los principales organismos oficiales que garantizan la máxima calidad tanto en productos como en sistemas de gestión.



Conformidad Europea



Evaluación Técnica Europea



Homologación Sísmica



Underwriters Laboratories



ICC-ES®



Resistencia al fuego



Emissiones VOC reducidas



Leadership in Energy and Environmental Design



Homologación FM



Útil de colocación para familia MT

DO-MT

MACIZOS



CÓDIGO	MEDIDA	€/PC		
DOMTA10	M6 - M8 - M10	10,302	5	225
DOMTA20	M12 - M14 - M16 - M20	17,171	5	225



Anclaje macho de suspensión

TWA

MACIZOS

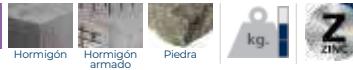

CÓDIGO	MEDIDA	€/100		
TWA06060	6 x 60 Ø6	29,547	100	2.400



Tapón de plástico para MT

TP-MT

METAL

PE

TP-MT BL ^{NEW}

Blanco

CÓDIGO	MEDIDA	€/100		
TPMTBL06	M6	19,630	500	3.000
TPMTBL08	M8	23,167	250	3.000
TPMTBL10	M10	25,660	250	1.000
TPMTBL12	M12	36,850	250	1.000
TPMTBL16	M16	53,340	100	400



METAL

PE

TP-MT NE ^{NEW}

Negro

CÓDIGO	MEDIDA	€/100		
TPMTNE06	M6	19,630	500	3.000
TPMTNE08	M8	23,167	250	3.000
TPMTNE10	M10	25,660	250	1.000
TPMTNE12	M12	36,850	250	1.000
TPMTNE16	M16	53,340	100	400



TH | TF

Los anclajes homologados de alto rendimiento de fijación directa en hormigón fisurado y no fisurado son la solución más profesional y efectiva. Su diseño permite una instalación rápida y sencilla garantizando las máximas prestaciones y unos mayores valores de cargas respecto a la versión anterior. El surtido de anclajes TH/TF consta de diferentes modelos de cabezas, aptos para la instalación en elementos estructurales y no estructurales como barandillas, estanterías o elementos que deban desinstalarse o ajustarse.



DISEÑO Y GEOMETRÍA



Rosca doble patentada, diseñada para incrustarse profundamente en el hormigón y garantizar las máximas cargas.



Cabeza THE/TFE: **Arandela estriada estampada en versiones hexagonales**, que asegura un apriete contra el material base, impidiendo que la fijación se afloje.



Cabeza: **Medida estampada en la cabeza** (excepto en Ø5). Permite identificar qué medida se ha instalado.



La **punta templada** garantiza una mayor dureza, durabilidad y facilidad durante la instalación.



Cuerpo de acero al carbono estampado de alta resistencia.

CUALIDADES Y VENTAJAS

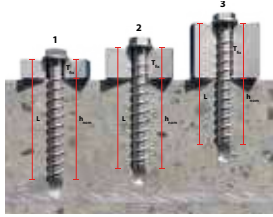

+ VERSÁTILIDAD

Permite la **instalación con hasta tres profundidades** de atornillado distintas (en versión Ø10).

Adicionalmente **permite desatornillarse** para nivelar o hacer un correcto ajuste del elemento instalado.

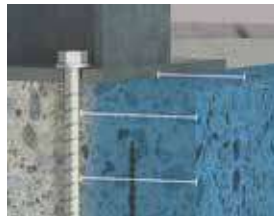

+ PRODUCTIVIDAD

- Genera bajas cargas sobre el hormigón, permitiendo **usar métricas más pequeñas** y, por consiguiente, hacer instalaciones con reducidas distancias entre anclajes y al borde del elemento de hormigón.
- No necesita par de apriete.** Permite asegurarnos de que siempre está perfectamente instalado.
- Instalación EXPRES.** Únicamente requiere un taladro y una máquina de impacto.

MÁXIMAS GARANTÍAS

- Homologado (ETA 20/0046) en opción 1 para la instalación en hormigón fisurado y no fisurado (C20/25-C50/60).
- Homologado (ETA 20/0494) para sistemas redundantes no estructurales en hormigón (C20/25) y losas alveolares (≥ C30/37).
- Homologado a resistencia a fuego R30-R120 en hormigón
- Homologación Sísmica C1&C2.
- Confirmada idoneidad para la instalación de sistemas de rociadores según la norma Vds CEA 4001.

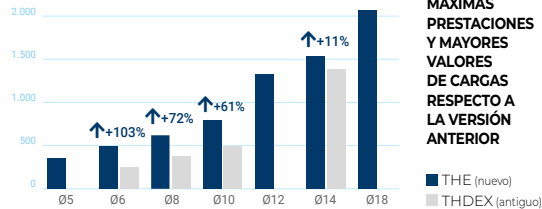

MÁXIMAS PRESTACIONES Y MAYORES VALORES DE CARGAS RESPECTO A LA VERSIÓN ANTERIOR

GAMA



PRODUCTO	THE	THA	THP	THT	TXE	TFE	TFN	TFS	TFM	TFF
TIPO DE CABEZA	Hexagonal	Avellanada	Alomada	Truss	Bimetal	Hexagonal	Hexagonal sin arandela	Espárrago	Rosca macho	Rosca hembra
RECUBRIMIENTO	Atlantis	Atlantis	Atlantis	Atlantis	A4	Zn	Zn	Zn	Zn	Zn
CE	✓	✓	✓	✓	✓	✓	✓	✓	✓	✓
CE	✓	✓	✓	✓	✓	✓	✓	✓	✓	✓
SEISMIC	✓	✓	✓	✓	✓	✓	✓	✓	✓	✓
SEISMIC	✓	✓	✓	✓	✓	✓	✓	✓	✓	✓
FUEGO	✓	✓	✓	✓	✓	✓	✓	✓	✓	✓
ATAJADA	✓	✓	✓	✓	✓	✓	✓	✓	✓	✓

APLICACIONES



Aplicaciones para versión homologada ETA 20/0046 (instalaciones en hormigón fisurado y no fisurado)

- Aplicaciones estructurales.
- Toldos o señalizaciones provisionales.
- Asientos en estadios.
- Estructuras de madera a hormigón.
- Barandillas y vallados.
- Estanterías y racks.
- Vigas y pilares estructurales.



Aplicaciones para versión homologada ETA 20/0494 (instalaciones no estructurales)

- Fijación de tuberías.
- Conductos de aire acondicionado.
- Bandejas eléctricas o sistemas de cableado.
- Instalaciones en techos de hormigón hueco.
- Instalaciones en techos de losas alveolares.

FABRICACIÓN 100% INDEX

Esto nos permite asegurar un riguroso control de los procesos, garantizar la máxima calidad en nuestros productos, brindar el mejor servicio y obtener un coste global competitivo.

EL RECUBRIMIENTO PERFECTO SEGÚN EL NIVEL DE CORROSIÓN



Recubrimiento Atlantis C3-H: válido para condiciones interiores secas (50 años) o en ambientes exteriores tipo C3 según la norma ISO 9223, por un período de 25 años.



Recubrimiento Cincado: apto para uso en condiciones interiores secas (categoría C1 según la norma ISO 923), por un período de 50 años.

Anclaje de fijación directa en hormigón

TH/TF

02 Info Técnica
P. 332

MACIZOS



CÓDIGO	HOMOLOGACIÓN SÍSMICA	ØBROCA X LONGITUD	€/100		ESPESOR MÁX. A FIJAR		
THE05040	-	Ø5 x 40	46,067	8	5	100	2.400
THE05050	-	Ø5 x 50	53,427	8	5	100	1.600
THE05060	-	Ø5 x 60	57,060	8	15	100	1.600
THE05080	-	Ø5 x 80	74,843	8	35	50	800
THE05100	-	Ø5 x 100	87,010	8	55	50	800
THE06040	-	Ø6 x 40	58,463	10	5	100	1.600
THE06050	C1	Ø6 x 50	63,167	10	15	100	1.200
THE06060	C1	Ø6 x 60	70,337	10	5	100	1.200
THE06070	C1	Ø6 x 70	77,953	10	15	50	600
THE06080	C1	Ø6 x 80	87,653	10	25	50	800
THE06100	C1	Ø6 x 100	110,160	10	45	25	400
THE06120	C1	Ø6 x 120	125,583	10	65	25	400
THE08055	C1 & C2	Ø8 x 55	117,673	13	5	50	600
THE08060	C1 & C2	Ø8 x 60	120,010	13	10	50	600
THE08070	C1 & C2	Ø8 x 70	132,390	13	5	50	200
THE08080	C1 & C2	Ø8 x 80	148,280	13	15	25	400
THE08090	C1 & C2	Ø8 x 90	160,057	13	25	25	400
THE08100	C1 & C2	Ø8 x 100	168,943	13	35	25	400
THE08110	C1 & C2	Ø8 x 110	176,567	13	45	25	400
THE08120	C1 & C2	Ø8 x 120	242,560	13	55	25	400
THE08140	C1 & C2	Ø8 x 140	249,630	13	75	25	300
THE10060	-	Ø10 x 60	222,307	15	5	50	200
THE10070	-	Ø10 x 70	241,273	15	15	50	200
THE10080	-	Ø10 x 80	259,587	15	25	50	300
THE10090	C1 & C2	Ø10 x 90	268,667	15	5	25	300
THE10100	C1 & C2	Ø10 x 100	277,257	15	15	25	300
THE10120	C1 & C2	Ø10 x 120	318,643	15	35	25	200
THE10140	C1 & C2	Ø10 x 140	353,493	15	55	25	100
THE12080	C1 & C2	Ø12 x 80	334,837	18	5	25	100
THE12090	-	Ø12 x 90	357,740	18	15	25	100
THE12110	C1 & C2	Ø12 x 110	408,707	18	5	25	100
THE12130	C1 & C2	Ø12 x 130	469,943	18	25	25	150
THE12150	C1 & C2	Ø12 x 150	520,620	18	45	25	100
THE14080	-	Ø14 x 80	513,083	21	5	25	150
THE14100	-	Ø14 x 100	609,290	21	25	25	150
THE14120	C1 & C2	Ø14 x 120	710,027	21	5	25	100
THE14130	C1 & C2	Ø14 x 130	805,510	21	15	25	100
THE14140	C1 & C2	Ø14 x 140	867,473	21	25	25	100
THE14160	C1 & C2	Ø14 x 160	943,767	21	45	25	50
THE16100	NEW	Ø16 x 100	826,687	-	20	25	100
THE16150	NEW	Ø16 x 150	1.150,703	-	30	25	75
THE18100	C1 & C2	Ø18 x 100	1.022,780	24	10	20	80
THE18130	C1 & C2	Ø18 x 130	1.193,700	24	40	20	40
THE18160	C1 & C2	Ø18 x 160	1.391,507	24	20	15	30
THE18180	C1 & C2	Ø18 x 180	1.505,443	24	40	15	30
THE18200	C1 & C2	Ø18 x 200	1.651,080	24	60	10	20

Homologado ETE Opt.1. Cabeza hexagonal con recubrimiento ATLANTIS C3-H



02 Info Técnica
P. 333

MACIZOS

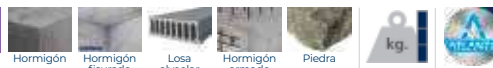

CÓDIGO	HOMOLOGACIÓN SÍSMICA	ØBROCA X LONGITUD	€/100		ESPESOR MÁX. A FIJAR		
THA05040	-	Ø5 x 40	54,380	TX25	5	100	2.400
THA05060	-	Ø5 x 60	64,053	TX25	15	100	1.200
THA05080	-	Ø5 x 80	81,180	TX25	35	50	800
THA05100	-	Ø5 x 100	91,513	TX25	55	50	800
THA06045	C1	Ø6 x 45	75,860	TX30	10	100	1.600
THA06050	C1	Ø6 x 50	79,100	TX30	15	100	1.200
THA06060	C1	Ø6 x 60	93,003	TX30	5	100	1.200
THA06080	C1	Ø6 x 80	112,020	TX30	25	100	600
THA06120	C1	Ø6 x 120	125,833	TX30	65	100	400
THA06140	C1	Ø6 x 140	161,323	TX30	85	100	600
THA08060	-	Ø8 x 60	153,210	TX45	10	50	200
THA08080	-	Ø8 x 80	186,177	TX45	15	25	400
THA08100	C1 & C2	Ø8 x 100	223,920	TX45	35	25	400
THA08120	C1 & C2	Ø8 x 120	251,283	TX45	55	25	400
THA10100	C1 & C2	Ø10 x 100	339,207	TX50	15	25	300
THA10120	C1 & C2	Ø10 x 120	393,763	TX50	35	25	200

Homologado ETE Opt.1. Cabeza avellanada con recubrimiento ATLANTIS C3-H



TH/TF

Anclaje de fijación directa en hormigón

THP

Homologado ETE Opt.1. Cabeza alomada con recubrimiento ATLANTIS C3-H

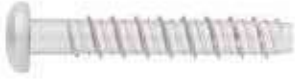

02 Info. Técnica P. 383

MACIZOS



CÓDIGO	HOMOLOGACIÓN SÍSMICA	ØBROCA X LONGITUD	€/100		ESPESOR MÁX. A FIJAR		
THP05040	-	Ø5 x 40	53,580	TX30	5	100	2.400
THP05060	-	Ø5 x 60	61,640	TX30	15	100	1.200
THP06040	-	Ø6 x 40	64,423	TX40	5	100	1.200
THP06050	C1	Ø6 x 50	75,967	TX40	15	100	1.200
THP06060	C1	Ø6 x 60	86,600	TX40	5	100	1.200
THP06080	C1	Ø6 x 80	107,390	TX40	25	50	600
THP06100	C1	Ø6 x 100	127,520	TX40	45	50	200
THP08060	-	Ø8 x 60	152,170	TX45	10	25	400
THP08080	-	Ø8 x 80	176,803	TX45	15	25	300

THT

Homologado ETE Opt.1. Cabeza Truss con recubrimiento ATLANTIS C3-H

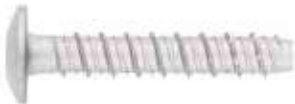

02 Info. Técnica P. 383

MACIZOS

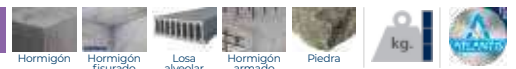

CÓDIGO	ØBROCA X LONGITUD	€/100		ESPESOR MÁX. A FIJAR		
THT06040	Ø6 x 40	83,800	TX30	5	100	1.600
THT06050	Ø6 x 50	99,760	TX30	15	100	1.200
THT06060	Ø6 x 60	113,727	TX30	5	100	400

NEW TXA

Homologado ETE Opt.1. Cabeza avellanada con punta Bimetal. Inoxidable A4



MACIZOS

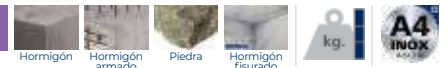

CÓDIGO	MEDIDA	€/100		ESPESOR MÁX. A FIJAR		
TXA08060	Ø8 x 60	372,600	TX45	10	50	
TXA08080	Ø8 x 80	445,003	TX45	15	25	
TXA08120	Ø8 x 120	588,647	TX45	55	25	
TXA10070	Ø10 x 70	535,117	TX50	15	50	
TXA10090	Ø10 x 90	661,480	TX50	5	25	
TXA10120	Ø10 x 120	829,027	TX50	35	25	

NEW TXE

Tornillo hormigón hexagonal con punta Bimetal. Inoxidable A4



MACIZOS

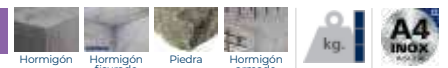

CÓDIGO	MEDIDA	€/100		ESPESOR MÁX. A FIJAR		
TXE06040	Ø6 x 40	224,863	10	5	100	
TXE06060	Ø6 x 60	251,333	10	5	100	
TXE08070	Ø8 x 70	362,343	13	5	50	
TXE08080	Ø8 x 80	400,000	13	15	25	
TXE08090	Ø8 x 90	450,000	13	25	25	
TXE08105	Ø8 x 105	525,027	13	40	25	
TXE10070	Ø10 x 70	441,697	15	15	50	
TXE10090	Ø10 x 90	567,897	15	5	25	
TXE10100	Ø10 x 100	609,187	15	15	25	
TXE10120	Ø10 x 120	693,627	15	35	25	
TXE12080	Ø12 x 80	659,273	18	5	25	
TXE12110	Ø12 x 110	906,500	18	5	25	

Anclaje de fijación directa en hormigón

TH/TF

02 Info
P. 383 Técnica

MACIZOS



CÓDIGO	HOMOLOGACIÓN SÍSMICA	ØBROCA X LONGITUD	€/100		ESPESOR MÁX. A FIJAR		
TFE05040	-	Ø5 x 40	39,253	8	5	100	2.400
TFE05050	-	Ø5 x 50	45,530	8	5	100	1.600
TFE05060	-	Ø5 x 60	48,630	8	15	100	1.600
TFE05080	-	Ø5 x 80	63,780	8	35	50	800
TFE05100	-	Ø5 x 100	74,147	8	55	50	800
TFE06040	-	Ø6 x 40	49,820	10	5	100	1.600
TFE06050	C1	Ø6 x 50	53,827	10	15	100	1.200
TFE06060	C1	Ø6 x 60	59,940	10	5	100	1.200
TFE06070	C1	Ø6 x 70	66,433	10	15	50	600
TFE06080	C1	Ø6 x 80	74,693	10	25	50	800
TFE06100	C1	Ø6 x 100	93,880	10	45	25	400
TFE06120	C1	Ø6 x 120	107,020	10	65	25	400
TFE08055	C1 & C2	Ø8 x 55	95,927	13	5	50	600
TFE08060	C1 & C2	Ø8 x 60	97,833	13	10	50	600
TFE08070	C1 & C2	Ø8 x 70	107,923	13	5	50	200
TFE08080	C1 & C2	Ø8 x 80	120,870	13	15	25	400
TFE08090	C1 & C2	Ø8 x 90	130,470	13	25	25	400
TFE08100	C1 & C2	Ø8 x 100	137,717	13	35	25	400
TFE08110	C1 & C2	Ø8 x 110	143,923	13	45	25	400
TFE08120	C1 & C2	Ø8 x 120	197,723	13	55	25	400
TFE08140	C1 & C2	Ø8 x 140	203,490	13	75	25	300
TFE10060	-	Ø10 x 60	172,977	15	5	50	200
TFE10070	-	Ø10 x 70	187,740	15	15	50	200
TFE10080	-	Ø10 x 80	201,987	15	25	50	300
TFE10090	C1 & C2	Ø10 x 90	209,060	15	5	25	300
TFE10100	C1 & C2	Ø10 x 100	215,733	15	15	25	300
TFE10120	C1 & C2	Ø10 x 120	247,943	15	35	25	200
TFE10140	C1 & C2	Ø10 x 140	275,057	15	55	25	100
TFE12080	-	Ø12 x 80	248,130	18	5	25	100
TFE12090	-	Ø12 x 90	265,107	18	15	25	100
TFE12110	C1 & C2	Ø12 x 110	302,870	18	5	25	100
TFE12130	C1 & C2	Ø12 x 130	348,253	18	25	25	150
TFE12150	C1 & C2	Ø12 x 150	385,810	18	45	25	100
TFE14080	-	Ø14 x 80	356,460	21	5	25	150
TFE14100	-	Ø14 x 100	423,297	21	25	25	150
TFE14120	C1 & C2	Ø14 x 120	493,280	21	5	25	100
TFE14130	C1 & C2	Ø14 x 130	559,620	21	15	25	100
TFE14140	C1 & C2	Ø14 x 140	602,670	21	25	25	100
TFE14160	C1 & C2	Ø14 x 160	655,667	21	45	25	50
TFE16100	NEW	Ø16 x 100	617,800	-	20	25	100
TFE16150	NEW	Ø16 x 150	853,137	-	30	25	75
TFE18100	C1 & C2	Ø18 x 100	710,563	24	10	20	80
TFE18130	C1 & C2	Ø18 x 130	829,307	24	40	20	40
TFE18160	C1 & C2	Ø18 x 160	966,733	24	20	15	30
TFE18180	C1 & C2	Ø18 x 180	1.045,890	24	40	15	30
TFE18200	C1 & C2	Ø18 x 200	1.147,067	24	60	10	20

TFE

Homologado ETE Opt.1. Cabeza hexagonal con recubrimiento cincado



02 Info
P. 384 Técnica

MACIZOS



CÓDIGO	HOMOLOGACIÓN SÍSMICA	ØBROCA X LONGITUD	€/100		ESPESOR MÁX. A FIJAR		
TFN14080	C1	Ø14 x 80	513,083	24	5	25	150

TFN

Homologado ETE Opt.1. Cabeza hexagonal con recubrimiento cincado y sin arandela



TH/TF

Anclaje de fijación directa en hormigón

TFS

Homologado ETE Opt.1. Espárrago cincado



02 Info. Técnica P. 384

MACIZOS

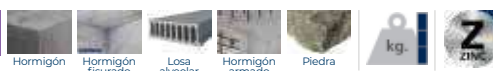

CÓDIGO	HOMOLOGACIÓN SÍSMICA	ØBROCA X LONGITUD	€/100	Nº HUELLA	ESPESOR MÁX. A FIJAR		
TFS06100	C1	Ø6 x 100 (M8)	145,240	5	35	50	800
TFS06120	C1	Ø6 x 120 (M8)	161,020	5	55	50	600
TFS08110	C1 & C2	Ø8 x 110 (M10)	215,297	7	32	50	400
TFS08130	C1 & C2	Ø8 x 130 (M10)	239,413	7	52	50	400
TFS10120	C1 & C2	Ø10 x 120 (M12)	313,570	8	27	25	200
TFS10140	C1 & C2	Ø10 x 140 (M12)	349,543	8	47	25	200

TFF

Homologado ETE Opt.1. Rosca hembra métrica cincado



02 Info. Técnica P. 384

MACIZOS

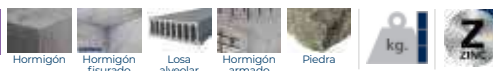

CÓDIGO	ØBROCA X LONGITUD	€/100			
TFF06035	Ø6 x 35 (M8-M10)	132,883	13	50	200
TFF06055	Ø6 x 55 (M8-M10)	143,477	13	50	200

TFM

Homologado ETE Opt.1. Rosca macho métrica cincado



02 Info. Técnica P. 384

MACIZOS

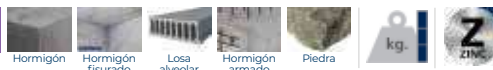

CÓDIGO	ØBROCA X LONGITUD	€/100	Nº HUELLA		
TFM06035	Ø6 x 35 (M8)	109,593	13	100	400
TFM06055	Ø6 x 55 (M10)	128,713	13	100	600

Tornillo para fijación directa

HO



Info Técnica
p. 385

MACIZOS



CÓDIGO	MEDIDA	€/100	LLAVE DE INSTALACIÓN	Ø BROCA		
HP75072	7,5 x 72 Ø6	39,712	TX30	6	100	1.200
HP75092	7,5 x 92 Ø6	48,914	TX30	6	100	1.200
HP75112	7,5 x 112 Ø6	62,726	TX30	6	100	800
HP75132	7,5 x 132 Ø6	71,923	TX30	6	100	600
HP75152	7,5 x 152 Ø6	93,633	TX30	6	100	600
HP75182	7,5 x 182 Ø6	137,528	TX30	6	100	300

HP

Cabeza plana, TX. Bicromatado



Bolsa autoservicio

CÓDIGO	MEDIDA	€/BOLSA	PCS	BOLSAS
LSHP75072	7,5 x 72 Ø6	6,170	14	7
LSHP75092	7,5 x 92 Ø6	7,228	14	7
LSHP75112	7,5 x 112 Ø6	7,624	12	7
LSHP75132	7,5 x 132 Ø6	8,740	12	7



Info Técnica
p. 385

MACIZOS



CÓDIGO	MEDIDA	€/100	LLAVE DE INSTALACIÓN	Ø BROCA		
HPZ75072	7,5 x 72 Ø6	39,712	TX30	6	100	1.200
HPZ75092	7,5 x 92 Ø6	48,914	TX30	6	100	1.200
HPZ75112	7,5 x 112 Ø6	62,726	TX30	6	100	800
HPZ75132	7,5 x 132 Ø6	71,923	TX30	6	100	600
HPZ75152	7,5 x 152 Ø6	93,633	TX30	6	100	600
HPZ75182	7,5 x 182 Ø6	137,528	TX30	6	100	300
HPZ75212	7,5 x 212 Ø6	193,192	TX30	6	100	300

HPZ

Cabeza plana, TX. Cincado



MACIZOS



CÓDIGO	COLOR	€/100	LLAVE DE INSTALACIÓN		
TPBLANC	BLANCO	5,098	TX30	2.000	24.000
TPMARRO	MARRÓN	5,098	TX30	2.000	24.000

HP TP

Tapón para tornillo HP



Info Técnica
p. 385

MACIZOS



CÓDIGO	MEDIDA	€/100	LLAVE DE INSTALACIÓN	Ø BROCA		
HR75072	7,5 x 72 Ø6	42,698	TX30	6	100	1.200
HR75092	7,5 x 92 Ø6	50,628	TX30	6	100	1.200
HR75112	7,5 x 112 Ø6	70,832	TX30	6	100	800
HR75132	7,5 x 132 Ø6	79,477	TX30	6	100	600

HR

Cabeza cilíndrica, TX



HO

Tornillo para fijación directa

HEA

Tornillo con cabeza hexagonal



MACIZOS



CÓDIGO	MEDIDA	€/100	LLAVE DE INSTALACIÓN	Ø BROCA		
HE65032	6,5 x 32 Ø5	17,594	8+ ranura	5	1.000	3.000
HE65045	6,5 x 45 Ø5	21,620	8+ ranura	5	500	2.000
HE65057	6,5 x 57 Ø5	27,884	8+ ranura	5	500	2.000
HE65070	6,5 x 70 Ø5	35,623	8+ ranura	5	500	1.500
HE65080	6,5 x 80 Ø5	42,441	8+ ranura	5	250	1.000
HE65100	6,5 x 100 Ø5	51,879	8+ ranura	5	250	750
HE65125	6,5 x 125 Ø5	68,607	8+ ranura	5	250	1.000
HE65115	6,5 x 115 Ø5	58,750	8+ ranura	5	250	1.000
HE65200	6,5 x 200 Ø5	153,032	8+ ranura	5	100	300
HE65180	6,5 x 180 Ø5	119,436	8+ ranura	5	100	400
HE65150	6,5 x 150 Ø5	74,238	8+ ranura	5	250	750

HEA + ARVUL

Tornillo montado con arandela vulcanizada de acero-EPDM



MACIZOS



CÓDIGO	MEDIDA	€/100	LLAVE DE INSTALACIÓN	Ø BROCA		
HE1665032	6,5 x 32 P16 Ø5	26,967	8+ ranura	5	1.000	2.000
HE1665045	6,5 x 45 P16 Ø5	31,757	8+ ranura	5	500	1.500
HE1665057	6,5 x 57 P16 Ø5	38,737	8+ ranura	5	500	1.500
HE1665070	6,5 x 70 P16 Ø5	43,843	8+ ranura	5	500	1.000
HE1665080	6,5 x 80 P16 Ø5	52,757	8+ ranura	5	250	750
HE1665100	6,5 x 100 P16 Ø5	61,737	8+ ranura	5	250	750
HE1665125	6,5 x 125 P16 Ø5	78,337	8+ ranura	5	250	500
HE1665200	6,5 X 200 P16 Ø5	176,737	8+ ranura	5	100	300
HE1665115	6,5 x 115 P16 Ø5	71,913	8+ ranura	5	250	750
HE1665180	6,5 x 180 P16 Ø5	137,937	8+ ranura	5	100	300
HE1665150	6,5 x 150 P16 Ø5	87,190	8+ ranura	5	250	500

Anclaje para grandes cargas en hormigón

SL

02 Info
P. 336 Técnica

MACIZOS

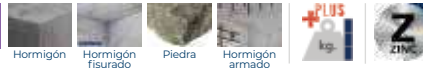

CÓDIGO	MEDIDA	€/100	ESPESOR MÁX. A FIJAR		
SLPT10070	M6 x 70 Ø10	264,833	10	50	600
SLPT10080	M6 x 80 Ø10	277,887	20	50	600
SLPT10100	M6 x 100 Ø10	310,140	40	50	300
SLPT10110	M6 x 110 Ø10	329,313	50	25	150
SLPT12080	M8 x 80 Ø12	319,297	5	50	300
SLPT12090	M8 x 90 Ø12	336,093	15	50	200
SLPT12100	M8 x 100 Ø12	350,260	25	50	200
SLPT12120	M8 x 120 Ø12	382,393	45	25	200
SLPT16100	M10 x 100 Ø16	546,117	15	25	150
SLPT16120	M10 x 120 Ø16	616,960	35	25	100
SLPT16140	M10 x 140 Ø16	696,707	55	20	60
SLPT16160	M10 x 160 Ø16	775,270	75	20	60
SLPT18110	M12 x 110 Ø18	760,320	10	20	80
SLPT18120	M12 x 120 Ø18	808,243	20	20	80
SLPT18140	M12 x 140 Ø18	892,317	40	20	80
SLPT18150	M12 x 150 Ø18	943,593	50	20	80
SLPT18170	M12 x 170 Ø18	1.060,063	70	15	45
SLPT18200	M12 x 200 Ø18	1.185,460	100	15	30
SLPT24140	M16 x 140 Ø24	1.370,210	20	10	40
SLPT24170	M16 x 170 Ø24	1.611,167	50	10	30
SLPT24200	M16 x 200 Ø24	1.859,033	80	10	20
SLPT24220	M16 x 220 Ø24	2.019,520	100	10	20
SLPT28170	M20 x 170 Ø28	2.130,817	20	10	20
SLPT28200	M20 x 200 Ø28	2.467,137	50	10	20
SLPT28240	M20 x 240 Ø28	2.940,770	90	5	10

SL-PT

Homologado ETE Opt.1. Cabeza hexagonal



02 Info
P. 336 Técnica

MACIZOS

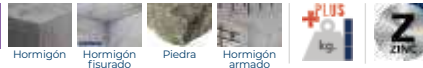

CÓDIGO	MEDIDA	€/100	ESPESOR MÁX. A FIJAR		
SLPC10070	M6 x 70 Ø10	374,510	10	50	600
SLPC10080	M6 x 80 Ø10	394,817	20	50	600
SLPC10100	M6 x 100 Ø10	431,547	40	50	300
SLPC12100	M8 x 100 Ø12	513,190	25	50	200
SLPC16100	M10 x 100 Ø16	741,060	15	25	150
SLPC16120	M10 x 120 Ø16	804,673	35	25	100
SLPC18120	M12 x 120 Ø18	996,913	20	20	80

SL-PC

Homologado ETE Opt.1. Cabeza avellanada



Los anclajes de camisa CH son una solución ideal para la instalación de elementos estructurales en hormigón no fisurado como pasamanos, líneas de cables, mobiliario urbano o estanterías metálicas.

La geometría del anclaje garantiza una gran capacidad de carga, un alto grado de seguridad y una sencilla instalación. Al apretar el anclaje, el cono se introduce en la camisa de expansión (sin girarse gracias a los antiguos), expandiéndola contra el material a fijar. El surtido de anclajes CH consta de diferentes modelos de cabezas en función del uso que se requiera.



DISEÑO Y GEOMETRÍA

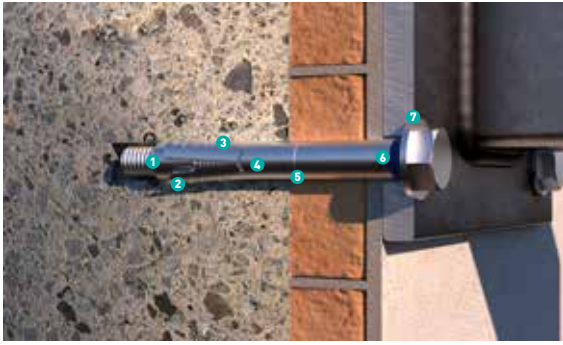

- 1. Cono con aletas antigiro** permite que el anclaje no gire, asegurando la expansión de la camisa y facilitando su instalación.
- 2. Apertura de la camisa.** Optimiza la inserción del cono y facilita su expansión.
- 3. Información práctica** para la instalación (diámetro y longitud) estampada en la camisa.
- 4. Diseño de la camisa** para asegurar una expansión más eficiente.
- 5. Marca de profundidad** requerida para asegurar un correcto rendimiento.
- 6. Goma azul** con aletas antigiro que facilitan la instalación.
- 7. Arandela** que aumenta la superficie de fijación.

CUALIDADES Y VENTAJAS



GARANTÍA ANTIGIRO. FACILITA LA INSTALACIÓN.

El anclaje consta de varios elementos antigiro (cono, camisa y goma) que permiten que el anclaje no gire cuando se comienza a instalar, facilitando la instalación y garantizando una óptima expansión y rendimiento.



MÁXIMAS GARANTÍAS. HOMOLOGADO ACORDE A LOS MÁX ALTOS ESTÁNDARES DE CALIDAD.

Homologado (ETA 18/0018) para usos no estructurales en hormigón.



VERSATILIDAD. MÚLTIPLES USOS.

Indicado para la instalación de cargas estáticas o cuasi-estáticas en hormigón no fisurado y hormigón armado. Permite el desmontaje del anclaje, desatornillando el tornillo o elemento roscado.

APLICACIONES



- Fijaciones estructurales en hormigón no fisurado.
- Fijación de señales, estanterías, paneles, pórticos, barandillas, toldos, postes de vallas.
- Mobiliario urbano, asientos de cines, teatros o estadios.
- Bandejas de cables
- Puertas
- Fachadas
- Fijaciones temporales

FABRICACIÓN 100% INDEX

Esto nos permite asegurar un riguroso control de los procesos, garantizar la máxima calidad en nuestros productos, brindar el mejor servicio y obtener un coste global competitivo.

GAMA



PRODUCTO	CH-TO	CH-A2	CH-8.8	CH-8.8 E	CH-PL	CH-PI	CH-ES	CH-INB	CH-INN
CABEZA DEL TORNILLO	Tornillo hexagonal 6.8	Tornillo hexagonal inoxidable A2	Tornillo hexagonal 8.8	Tornillo especial para espesores reducidos	Cabeza plana	Cabeza plana inoxidable A2	Espárrago	Cabeza inviolable	Cabeza inviolable lacada en negro
RECUBRIMIENTO/ MATERIAL DEL TORNILLO	Z	A2 INOX	Z	Z	Z	A2 INOX	Z	Z	A2 INOX



PRODUCTO	CH-GA	CH-GE	CH-GF	CH-GF A2	CH-AR	CH-AF	CH-AF A2
CABEZA DEL TORNILLO	Gancho	Gancho espiral	Gancho forjado	Gancho forjado inoxidable A2	Argolla	Argolla forjada	Argolla forjada inoxidable A2
RECUBRIMIENTO/ MATERIAL DEL TORNILLO	Z	Z	Z	A2 INOX	Z	Z	A2 INOX



EL RECUBRIMIENTO PERFECTO SEGÚN EL NIVEL DE CORROSIÓN



Recubrimiento Cincado: apto para uso en condiciones interiores secas (categoría C1 según la norma ISO 923), por un periodo de 50 años.



Recubrimiento Cincado negro: apto para uso en condiciones interiores secas (categoría C1 según la norma ISO 923), por un periodo de 50 años.



Material Inoxidable A2: válido para espacios interiores con alta frecuencia de condensación o ambientes exteriores que no estén situados próximas a zonas costeras o de elevada contaminación.

Anclaje antigiro para cargas medias

CH

Info
Técnica
P. 397

MACIZOS

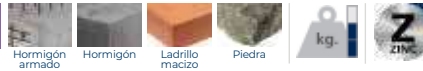

CÓDIGO	MEDIDA	€/100		
ACHT08C	M6 x 45 Ø8	30,463	200	1.200
ACHT08L	M6 x 60 Ø8	35,296	200	800
• ACHT09C	M6 x 45 Ø9	37,943	200	800
• ACHT09L	M6 x 60 Ø9	42,950	200	800
• ACHT10C	M8 x 60 Ø10	48,615	100	600
• ACHT10L	M8 x 80 Ø10	56,991	100	400
• ACHT11C	M8 x 60 Ø11	57,637	100	400
• ACHT11L	M8 x 80 Ø11	69,417	100	400
• ACHT12C	M10 x 70 Ø12	77,561	100	200
• ACHT12L	M10 x 100 Ø12	95,846	50	200
• ACHT14C	M10 x 70 Ø14	97,742	100	200
• ACHT14L	M10 x 100 Ø14	118,807	50	200
• ACHT16C	M12 x 80 Ø16	150,382	50	200
• ACHT16L	M12 x 110 Ø16	182,463	50	100
• ACHT20C	M16 x 110 Ø20	328,801	25	50
• ACHT25C	M20 x 130 Ø25	949,050	15	45

• Medidas sin homologar

CH-TO

Tornillo hexagonal 6.8. Homologado ETE Opt.7



Blíster

CÓDIGO	MEDIDA	€/BOLSA	PCS	BOLSAS
BZACHT08C	M6 x 45 Ø8	3,216	2	15
BZACHT08L	M6 x 60 Ø8	3,216	2	15
BZACHT10C	M8 x 60 Ø10	3,216	2	15
BZACHT10L	M8 x 80 Ø10	3,216	2	15
BZACHT12C	M10 x 70 Ø12	3,216	2	10
BZACHT12L	M10 x 100 Ø12	3,216	2	10

Caja ventana

CÓDIGO	MEDIDA	€/CAJA	PCS	CAJAS
VACHT08C	M6 x 45 Ø8	5,863	15	8
VACHT08L	M6 x 60 Ø8	6,599	15	8
VACHT10C	M8 x 60 Ø10	6,210	10	8
VACHT10L	M8 x 80 Ø10	7,279	10	8
VACHT12C	M10 x 70 Ø12	7,844	8	8
VACHT12L	M10 x 100 Ø12	7,459	6	8
VACHT16C	M12 x 80 Ø16	7,544	4	8

Bolsa autoservicio

CÓDIGO	MEDIDA	€/BOLSA	PCS	BOLSAS
LSACHT08C	M6 x 45 Ø8	9,206	24	6
LSACHT08L	M6 x 60 Ø8	7,249	16	6
LSACHT10C	M8 x 60 Ø10	5,410	8	6
LSACHT10L	M8 x 80 Ø10	5,951	8	6
LSACHT12C	M10 x 70 Ø12	7,844	8	6
LSACHT12L	M10 x 100 Ø12	9,109	8	6
LSACHT16C	M12 x 80 Ø16	7,583	4	5

Info
Técnica
P. 397

INOXIDABLE

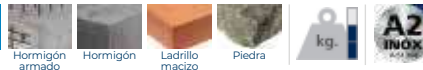

CÓDIGO	MEDIDA	€/100		
ACHTA208C	M6 x 45 Ø8	109,583	100	1.200
ACHTA208L	M6 x 60 Ø8	123,800	100	600
• ACHTA209C	M6 x 45 Ø9	124,010	100	1.200
• ACHTA209L	M6 x 60 Ø9	143,233	100	600
• ACHTA210C	M8 x 60 Ø10	177,550	100	600
• ACHTA210L	M8 x 80 Ø10	204,243	100	400
• ACHTA211C	M8 x 60 Ø11	213,603	100	400
• ACHTA211L	M8 x 80 Ø11	251,620	100	400
• ACHTA212C	M10 x 70 Ø12	299,513	100	200
• ACHTA212L	M10 x 100 Ø12	366,293	50	200
• ACHTA214C	M10 x 70 Ø14	398,427	100	300
• ACHTA214L	M10 x 100 Ø14	444,400	50	200
• ACHTA216C	M12 x 80 Ø16	590,597	50	100
• ACHTA216L	M12 x 110 Ø16	747,340	50	100
• ACHTA220C	M16 x 110 Ø20	1.534,333	25	75

• Medidas sin homologar

CH-A2

Inoxidable A2. Homologado ETE Opt.7



Blíster

CÓDIGO	MEDIDA	€/BOLSA	PCS	BOLSAS
BZACHTA208C	M6 x 45 Ø8	4,463	2	15
BZACHTA208L	M6 x 60 Ø8	4,463	2	15
BZACHTA210C	M8 x 60 Ø10	4,463	2	15
BZACHTA210L	M8 x 80 Ø10	4,463	2	15

Caja ventana

CÓDIGO	MEDIDA	€/CAJA	PCS	CAJAS
VACHTA208C	M6 x 45 Ø8	12,948	10	8
VACHTA208L	M6 x 60 Ø8	15,055	10	8
VACHTA210C	M8 x 60 Ø10	13,481	6	8
VACHTA210L	M8 x 80 Ø10	16,052	6	8
VACHTA212C	M10 x 70 Ø12	15,128	4	8
VACHTA212L	M10 x 100 Ø12	18,672	4	8

Bolsa autoservicio

CÓDIGO	MEDIDA	€/BOLSA	PCS	BOLSAS
LSACHTA208C	M6 x 45 Ø8	13,985	12	6
LSACHTA208L	M6 x 60 Ø8	16,258	12	6
LSACHTA210C	M8 x 60 Ø10	16,179	8	6
LSACHTA210L	M8 x 80 Ø10	19,262	8	6
LSACHTA212C	M10 x 70 Ø12	20,427	6	6
LSACHTA212L	M10 x 100 Ø12	18,672	4	5

CH

Anclaje antigiro para cargas medias

CH-8.8

Tornillo hexagonal 8.8. Homologado ETE Opt.7



02 P. 387 Info. Técnica

MACIZOS

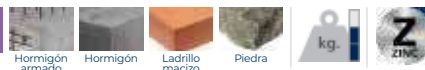

CÓDIGO	MEDIDA	€/100		
ACHT8808C	M6 x 45 Ø8	33,444	200	1.200
ACHT8808L	M6 x 60 Ø8	38,987	200	800
ACHT8810C	M8 x 60 Ø10	53,461	100	600
ACHT8810L	M8 x 80 Ø10	62,913	100	400
ACHT8812C	M10 x 70 Ø12	86,841	100	200
ACHT8812L	M10 x 100 Ø12	106,060	50	200
ACHT8816C	M12 x 80 Ø16	167,490	50	200
ACHT8816L	M12 x 110 Ø16	203,427	50	100
ACHT8820C	M16 x 110 Ø20	368,093	25	50

CH-8.8 E

Tornillo hexagonal 8.8 para espesores reducidos



02 P. 388 Info. Técnica

MACIZOS

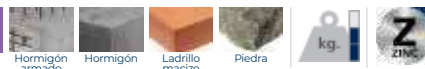

CÓDIGO	MEDIDA	€/100		
ACHT8808E	M6 x 40 Ø8	40,799	200	1.200
ACHT8810E	M8 x 40 Ø10	67,467	100	600

CH-PL

Cabeza plana. Homologado ETE Opt.7



02 P. 388 Info. Técnica

MACIZOS

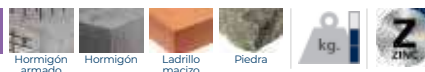

CÓDIGO	MEDIDA	€/100			
ACHTPL08C	M6 x 45 Ø8	51,120	4	100	1.600
ACHTPL08L	M6 x 60 Ø8	74,970	4	100	1.200
ACHTPL10C	M8 x 60 Ø10	84,007	5	100	400
ACHTPL10L	M8 x 80 Ø10	113,247	5	100	600
ACHTPL12C	M10 x 70 Ø12	148,747	6	50	400
ACHTPL12L	M10 x 100 Ø12	255,027	6	50	300

CH-PI

Cabeza plana inoxidable A2. Homologado ETE Opt.7



02 P. 388 Info. Técnica

INOXIDABLE

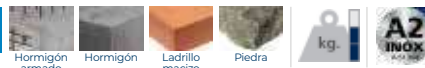

CÓDIGO	MEDIDA	€/100			
ACHTPI08C	M6 x 45 Ø8	113,997	4	100	1.200
ACHTPI08L	M6 x 60 Ø8	145,963	4	100	1.200
ACHTPI10C	M8 x 60 Ø10	215,057	5	100	600
ACHTPI10L	M8 x 80 Ø10	254,583	5	100	400
ACHTPI12C	M10 x 70 Ø12	340,053	6	50	300
ACHTPI12L	M10 x 100 Ø12	401,477	6	50	300

Anclaje antigiro para cargas medias

CH

02 Info
P. 388 Técnica

MACIZOS

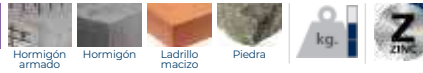

CÓDIGO	MEDIDA	€/100			
ACHINB08C	M6 x 45 Ø8	52,660	TX40	100	1.200
ACHINB08L	M6 x 60 Ø8	60,353	TX40	100	800
ACHINB10C	M8 x 60 Ø10	74,683	TX40	100	600
ACHINB10L	M8 x 80 Ø10	88,083	TX40	100	400

02 Blíster

CÓDIGO	MEDIDA	€/BOLSA	PCS B	BOLSAS
BZACHINB08C	M6 x 45 Ø8	3,216	2	15
BZACHINB10C	M8 x 60 Ø10	3,216	2	15

CH-INB

Cabeza inviolable cincada.
Homologado ETE Opt.7



02 Info
P. 388 Técnica

MACIZOS

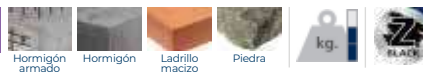

CÓDIGO	MEDIDA	€/100			
ACHINN08C	M6 x 45 Ø8	64,173	TX40	100	1.200
ACHINN08L	M6 x 60 Ø8	71,893	TX40	100	800
ACHINN10C	M8 x 60 Ø10	86,377	TX40	100	600
ACHINN10L	M8 x 80 Ø10	103,740	TX40	100	400

CH-INN

Cabeza inviolable cincada negra.
Homologado ETE Opt.7



02 Info
P. 388 Técnica

MACIZOS

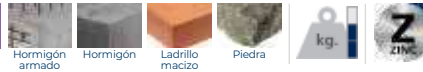

CÓDIGO	MEDIDA	€/100		
ACHE08C	M6 x 45 Ø8	60,057	200	1.200
ACHE09C	M6 x 45 Ø9	62,163	200	800
ACHE10C	M8 x 60 Ø10	88,833	100	600
ACHE10L	M8 x 80 Ø10	103,443	100	400
ACHE11C	M8 x 60 Ø11	97,960	100	600
ACHE11L	M8 x 80 Ø11	108,263	100	400
ACHE12C	M10 x 70 Ø12	125,877	100	200
ACHE12L	M10 x 100 Ø12	164,747	50	200
ACHE14C	M10 x 70 Ø14	138,437	100	200
ACHE14L	M10 x 100 Ø14	185,903	50	200

CH-ES

Espárrago



CH

Anclaje antigiro para cargas medias

CH-GA

Gancho



02 Info. Técnica
P. 388

MACIZOS

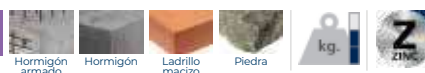

CÓDIGO	MEDIDA	€/100	APERTURA GANCHO		
ACHG08C	M6 x 45 Ø8	54,390	10	100	600
ACHG09C	M6 x 45 Ø9	59,542	10	100	600
ACHG10C	M8 x 60 Ø10	88,605	13	100	400
ACHG11C	M8 x 60 Ø11	98,591	13	100	400
ACHG12C	M10 x 70 Ø12	141,870	14	50	200
ACHG14C	M10 x 70 Ø14	164,275	14	50	200
ACHG16C	M12 x 80 Ø16	260,323	22	25	100

02 Blíster
P. 388

02 Caja ventana

02 Bolsa autoservicio

CÓDIGO	MEDIDA	€/BOLSA	PCS	BOLSAS
BZACHG08C	M6 x 45 Ø8	3,216	2	15
BZACHG10C	M8 x 60 Ø10	3,216	2	15
BZACHG12C	M10 x 70 Ø12	3,216	2	10

CÓDIGO	MEDIDA	€/CAJA	PCS	CAJAS
VACHG08C	M6 x 45 Ø8	6,551	10	8
VACHG10C	M8 x 60 Ø10	6,649	6	8

CÓDIGO	MEDIDA	€/BOLSA	PCS	BOLSAS
LSACHG08C	M6 x 45 Ø8	7,678	12	6
LSACHG10C	M8 x 60 Ø10	6,649	6	6

CH-GE

Gancho espiral



02 Info. Técnica
P. 389

MACIZOS

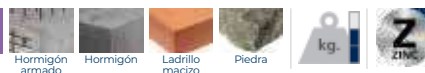

CÓDIGO	MEDIDA	€/100		
ACHGE10	M8 x 115 Ø10	197,917	25	200
ACHGE12	M10 x 135 Ø12	232,863	15	90

CH-GF

Gancho forjado



02 Info. Técnica
P. 389

MACIZOS

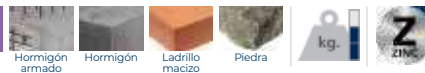

CÓDIGO	MEDIDA	€/100	APERTURA GANCHO		
ACHGF008C	M6 x 45 Ø8	108,940	10	100	600
ACHGF010C	M8 x 60 Ø10	148,337	11	100	400
ACHGF012C	M10 x 70 Ø12	238,263	14	50	200

CH-GF A2

Gancho forjado. Inoxidable A2



02 Info. Técnica
P. 389

INOXIDABLE

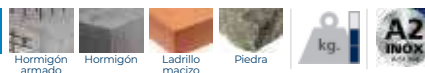

CÓDIGO	MEDIDA	€/100	APERTURA GANCHO		
ACHGA208C	M6 x 45 Ø8	447,373	10	100	600
ACHGA210C	M8 x 60 Ø10	664,537	11	100	400
ACHGA212C	M10 x 70 Ø12	881,316	14	50	200

Anclaje antigiro para cargas medias

CH

02 Info
Técnica
P. 328

MACIZOS



CÓDIGO	MEDIDA	€/100	Ø OJO		
ACHA08C	M6 x 45 Ø8	54,390	10	100	600
ACHA09C	M6 x 45 Ø9	59,542	10	100	600
ACHA10C	M8 x 60 Ø10	88,605	13	100	400
ACHA11C	M8 x 60 Ø11	98,591	13	100	200
ACHA12C	M10 x 70 Ø12	141,870	14	50	200
ACHA14C	M10 x 70 Ø14	164,275	14	50	200
ACHA16C	M12 x 80 Ø16	260,323	22	25	100

CH-AR

Argolla



02 Info
Técnica
P. 328

Blíster

CÓDIGO	MEDIDA	€/BOLSA	PCS	BOLSAS
BZACHA08C	M6 x 45 Ø8	3,216	2	15
BZACHA10C	M8 x 60 Ø10	3,216	2	15
BZACHA12C	M10 x 70 Ø12	3,216	2	10

02 Info
Técnica
P. 328

Caja ventana

CÓDIGO	MEDIDA	€/CAJA	PCS	CAJAS
VACHA08C	M6 x 45 Ø8	6,877	10	8
VACHA10C	M8 x 60 Ø10	6,855	6	8

02 Info
Técnica
P. 328

Bolsa autoservicio

CÓDIGO	MEDIDA	€/BOLSA	PCS	BOLSAS
LSACHA08C	M6 x 45 Ø8	9,373	14	6
LSACHA10C	M8 x 60 Ø10	6,855	6	6

02 Info
Técnica
P. 328

MACIZOS

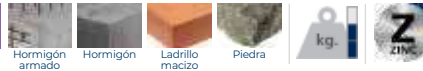

CÓDIGO	MEDIDA	€/100	Ø OJO		
ACHAFO08C	M6 x 45 Ø8	104,143	10	100	600
ACHAFO10C	M8 x 60 Ø10	136,033	12	100	400
ACHAFO12C	M10 x 70 Ø12	208,803	14	50	200

CH-AF

Argolla forjada



02 Info
Técnica
P. 328

INOXIDABLE

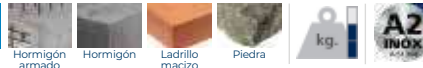

CÓDIGO	MEDIDA	€/100	Ø OJO		
ACHAA208C	M6 x 45 Ø8	491,243	10	100	600
ACHAA210C	M8 x 60 Ø10	783,613	11	100	400
ACHAA212C	M10 x 70 Ø12	1.045,200	14	50	200

CH-AF A2

Argolla forjada. Inoxidable A2



Disponibles ganchos, argollas y gancho espiral por separado en las páginas 328 y 329



HE

Los anclajes de expansión por deformación con rosca hembra están indicados para la instalación de tuberías, bandejas porta cables, conductos de ventilación o sistemas rociadores contraincendios. Disponen de homologación europea ETE para aplicaciones estructurales en hormigón no fisurado (según DEE 332023) y para fijación de sistemas redundantes no estructurales en hormigón fisurado incluyendo condiciones de exposición a fuego (según DEE 330747). Disponibles con recubrimiento ATLANTIS C3-L, inoxidable A4 y cincado, permitiendo su instalación en aplicaciones interiores como exteriores.



DISEÑO Y GEOMETRÍA

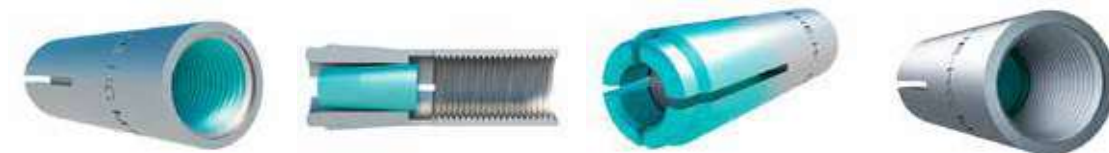

Rosca interior. El anclaje tiene una primera parte con rosca hembra, donde se instala el perno métrico y/o la varilla roscada (no suministrada con el producto). Su rosca interna métrica permite la aplicación en múltiples instalaciones, garantizando una máxima versatilidad.

Cono interior. En la parte inferior dispone de un cono interior que durante la instalación produce una expansión de las aletas de la camisa.

Aletas. La expansión del cono interior produce una expansión de las aletas, generando un rozamiento contra las paredes del material base, que permite la fijación.

Protección. El plástico ubicado en el interior del anclaje, evita que el cono se caiga durante la instalación o transporte de la caja.



Versión con collarín HE-CL. La versión con collarín previene que el anclaje se introduzca en exceso en el agujero del material base durante la instalación en caso de haber realizado un agujero más profundo del requerido en la documentación.

Identificación. La medida del anclaje está troquelada en el cuerpo del anclaje para facilitar su identificación y así saber en todo momento el diámetro de broca necesario, así como el útil de expansión a utilizar.

Versión corta, HE-HC. La versión HE-HC permite la instalación en zonas donde se presuma una alta densidad de armaduras de refuerzo; por ejemplo, en la parte inferior de forjados. Dada su escasa longitud (25 mm) no es previsible que incida en la armadura.

APLICACIONES



Anclaje para fijación de sistemas estructurales y no estructurales

- Instalaciones de techos suspendidos
- Sistemas de rociadores contraincendios
- Sistemas de suspensión para tuberías
- Bajantes con varillas
- Sistemas de ventilación y/o conductos de aire
- Bandejas portacables
- Fijación de sistemas estructurales en hormigón no fisurado con cargas estáticas o cuasi-estáticas
- Fijación de sistemas no estructurales redundantes en hormigón fisurado o aplicaciones puntuales en hormigón no fisurado.

FABRICACIÓN 100% INDEX

Esto nos permite asegurar un riguroso control de los procesos, garantizar la máxima calidad en nuestros productos, brindar el mejor servicio y obtener un coste global competitivo.

CUALIDADES Y VENTAJAS

ANCLAJE DESMONTABLE Y REUTILIZABLE.

Los tornillos o varillas utilizados pueden ser desmontados, dejando la superficie diáfana (queda la camisa y el cono en el interior del taladro). El anclaje instalado se puede utilizar para una nueva fijación.

MÁXIMAS GARANTÍAS. PRODUCTOS HOMOLOGADOS ACORDE A LOS MÁS ALTOS ESTÁNDARES DE CALIDAD.

- Homologado (ETA 14/0135) para sistemas no estructurales redundantes en hormigón fisurado y no fisurado (C12/15 a C50/60), incluyendo condiciones de exposición a fuego.
- Homologado (ETA 14/0068) para aplicaciones estructurales en hormigón no fisurado (C20/25-C50/60).
- Homologado FM para instalación de sistemas de rociadores contraincendios.
- Confirmada idoneidad para la instalación de sistemas de rociadores según la norma VdS CEA 4001.



FÁCIL INSTALACIÓN.

Gracias al útil EXP con protector de goma, permite una expansión del anclaje controlada, segura y ergonómica.

¿Cómo saber si el anclaje está correctamente instalado?

Una vez introducida la camisa en el agujero, golpear con el expansionador hasta que el borde superior de la camisa se quede marcada con unas muescas.



GAMA



PRODUCTO	HE-HO	HE-A4	HE-CL	HE-C4	HE-HC	HE-NO	HE-NS
RECUBRIMIENTO/MATERIAL	Z	A4 INOX	Z	A4 INOX	Z	Z	ATLANTIS
CE	✓	✓	✓	✓	✓	✓	✓
CE	✓	✓	✓	✓	✓	✓	✓
Fire	✓	✓	✓	✓	✓	✓	✓
FM	✓	✓	✓	✓	✓	✓	✓
EXP	✓	✓	✓	✓	✓	✓	✓

EL RECUBRIMIENTO PERFECTO SEGÚN EL NIVEL DE CORROSIÓN

Recubrimiento Atlantis C3-L: válido para condiciones interiores secas (50 años) o en ambientes exteriores tipo C3 según la norma ISO 9223, por un periodo de 25 años.

Recubrimiento Cincado: apto para uso en condiciones interiores secas (categoría C1 según la norma ISO 9223), por un periodo de 50 años.

Material Inoxidable A4: válido para interior y exterior, en zonas costeras o industriales, zonas expuestas a alta contaminación o zonas cercanas a carreteras.

Anclaje hembra con cono interior para grandes cargas

HE

02
P. 389
Info
Técnica

MACIZOS



CÓDIGO	MEDIDA	€/100	LONGITUD		
HEHOM06	M6 x 25 Ø8	17,571	25	100	3.200
HEHOM08	M8 x 30 Ø10	21,954	30	100	1.600
HEHOM10	M10 x 40 Ø12	35,700	40	50	800
HEHOM12	M12 x 50 Ø15	61,982	50	50	400
HEHOM16	M16 x 65 Ø20	179,682	65	25	200
HEHOM20	M20 x 80 Ø25	392,043	80	25	100
HEHOM12D	M12 x 50 Ø16	76,599	50	50	400

HE-HO

Cincado. Homologado ETE Opt.7 y para aplicaciones no estructurales



02
P. 390
Info
Técnica

INOXIDABLE

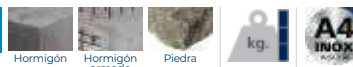

CÓDIGO	MEDIDA	€/100	LONGITUD		
HEA4M06	M6 x 25 Ø8	108,158	25	100	4.000
HEA4M08	M8 x 30 Ø10	154,220	30	100	1.600
HEA4M10	M10 x 40 Ø12	243,967	40	50	800
HEA4M12	M12 x 50 Ø15	461,453	50	50	600
HEA4M16	M16 x 65 Ø20	979,605	65	25	250
HEA4M20	M20 x 80 Ø25	1.784,273	80	25	100

HE-A4

Inoxidable A4. Homologado ETE Aplicaciones no estructurales



02
P. 390
Info
Técnica

MACIZOS



CÓDIGO	MEDIDA	€/100	LONGITUD		
HECLOM06	M6 x 25 Ø8	20,781	25	100	3.200
HECLOM08	M8 x 30 Ø10	27,660	30	100	1.600
HECLOM10	M10 x 40 Ø12	43,242	40	50	800
HECLOM12	M12 x 50 Ø15	76,733	50	50	400
HECLOM16	M16 x 65 Ø20	220,587	65	25	200
HECLOM12D	M12 x 50 Ø16	89,808	50	50	400

HE-CL

Con collarín. Cincado. Homologado ETE Opt.7 y para aplicaciones no estructurales



02
P. 390
Info
Técnica

INOXIDABLE



CÓDIGO	MEDIDA	€/100	LONGITUD		
HEC4M06	M6 x 25 Ø8	141,623	25	100	3.200
HEC4M08	M8 x 30 Ø10	202,781	30	100	1.600
HEC4M10	M10 x 40 Ø12	313,291	40	50	800
HEC4M12	M12 x 50 Ø15	563,284	50	50	400

HE-C4

Con collarín. Inoxidable A4. Homologado ETE Aplicaciones no estructurales



HE

Anclaje hembra con cono interior para grandes cargas

HE-HC

Versión corta. Cincado. Homologado ETE Aplicaciones no estructurales



02 Info. Técnica P. 390

MACIZOS

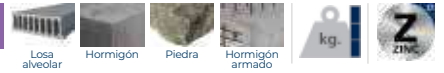

CÓDIGO	MEDIDA	€/100	LONGITUD		
HEHCM08	M8 x 25	25,719	25	100	1.600
HEHCM10	M10 x 25	41,889	25	50	800
HEHCM12	M12 x 25	75,296	25	50	800

HE-NO

Cincado



02 Info. Técnica P. 390

MACIZOS



CÓDIGO	MEDIDA	€/100	LONGITUD		
HENOM06	M6 x 25 Ø8	14,119	25	100	4.000
HENOM08	M8 x 30 Ø10	19,499	30	100	2.200
HENOM10	M10 x 40 Ø12	31,913	40	50	1.000
HENOM12	M12 x 50 Ø15	58,663	50	50	600
HENOM16	M16 x 65 Ø20	147,830	65	25	250
HENOM20	M20 x 80 Ø25	276,683	80	25	100

Blíster

CÓDIGO	MEDIDA	€/BOLSA	PCS	BOLSAS
BZHENOM06	M6 x 25 Ø8	3,216	4	20
BZHENOM08	M8 x 30 Ø10	3,216	4	20
BZHENOM10	M10 x 40 Ø12	3,216	2	15

Caja ventana

CÓDIGO	MEDIDA	€/CAJA	PCS	CAJAS
VHENOM06	M6 x 25 Ø8	3,346	15	8
VHENOM08	M8 x 30 Ø10	4,085	15	8

Bolsa autoservicio

CÓDIGO	MEDIDA	€/BOLSA	PCS	BOLSAS
LSHENOM06	M6 x 25 Ø8	5,553	30	7
LSHENOM08	M8 x 30 Ø10	7,146	30	7
LSHENOM10	M10 x 40 Ø12	6,863	16	7

HE-NS

ATLANTIS C3-L



02 Info. Técnica P. 390

MACIZOS



CÓDIGO	MEDIDA	€/100	LONGITUD		
HENSM08	M8 x 30 Ø10	30,687	30	100	1.600
HENSM10	M10 x 40 Ø12	49,673	40	50	1.000
HENSM12	M12 x 50 Ø15	91,317	50	50	400
HENSM16	M16 x 65 Ø20	230,113	65	25	250

NEW HE-HO SDS

Broca SDS con tope para HE-HO



MACIZOS

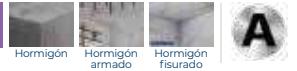

CÓDIGO	MEDIDA	€/PC		
HEHOSDS06	Ø8 x 27	13,419	1	10
HEHOSDS08	Ø10 x 33	15,321	1	10
HEHOSDS10	Ø12 x 43	19,134	1	10
HEHOSDS12	Ø15 x 54	24,863	1	10

NEW HE-HC SDS

Broca SDS con tope para HE-HC



MACIZOS



CÓDIGO	MEDIDA	€/PC		
HEHCSDS08	Ø10 x 28	15,321	1	10
HEHCSDS10	Ø12 x 28	19,134	1	10
HEHCSDS12	Ø15 x 29	24,856	1	10

Anclaje hembra con cono interior para grandes cargas

HE

MACIZOS



CÓDIGO	MEDIDA	€/100	LONGITUD		
EXHBM06	M6	1.287,942	210	1	10
EXHBM08	M8	1.287,942	210	1	10
EXHBM10	M10	1.287,942	210	1	10
EXHBM12	M12	1.287,942	210	1	10
EXHBM16	M16	1.504,643	210	1	10
EXHBM20	M20	1.567,337	210	1	10

EXP

Expansionador manual para anclajes hembra (excepto HE-HC)



MACIZOS



CÓDIGO	MEDIDA	€/100	LONGITUD		
EXHBM08C	M8 (HE-HC)	1.192,539	210	1	10
EXHBM10C	M10 (HE-HC)	1.192,539	210	1	10
EXHBM12C	M12 (HE-HC)	1.192,539	210	1	10

EXP-C

Expansionador manual para anclajes hembra HE-HC



Anclaje para losa alveolar. Homologado ETE

HC



HUECOS



CÓDIGO	MEDIDA	€/100	Ø BROCA		
HCM06	M6	67,997	10	100	600
HCM08	M8	80,235	12	50	600
HCM10	M10	114,136	16	25	300



Taco de latón para fijaciones ligeras en materiales macizos

TALA



MACIZOS



CÓDIGO	MEDIDA	€/100	Ø BROCA		
TALA532	W5/32 x 16 Ø5	13,400	5	300	9.600
TALAM04	M4 x 16 Ø5	13,400	5	300	9.600
TALAM05	M5 x 18 Ø6	21,429	6	200	6.400
TALAM06	M6 x 23 Ø8	29,547	8	200	4.800
TALAM08	M8 x 28 Ø10	53,044	10	100	2.400
TALAM10	M10 x 33 Ø12	82,866	12	150	1.800
TALAM12	M12 x 38 Ø15	172,843	15	150	900



Blíster

Caja ventana

Bolsa autoservicio

CÓDIGO	MEDIDA	€/BOLSA	PCS	BOLSAS
BZTALAM06	M6 x 23 Ø8	3,216	4	20
BZTALAM08	M8 x 28 Ø10	3,216	4	20
BZTALAM10	M10 x 33 Ø12	3,216	2	15

CÓDIGO	MEDIDA	€/CAJA	PCS	CAJAS
VTALAM06	M6 x 23 Ø8	8,225	25	8
VTALAM08	M8 x 28 Ø10	8,733	15	8
VTALAM10	M10 x 33 Ø12	13,764	15	8

CÓDIGO	MEDIDA	€/BOLSA	PCS	BOLSAS
LSTALAM06	M6 x 23 Ø8	14,801	50	8
LSTALAM08	M8 x 28 Ø10	15,727	30	7
LSTALAM10	M10 x 33 Ø12	20,641	25	5

TA-ME

Taco de expansión metálico



02 Info. Técnica
P. 391

MACIZOS

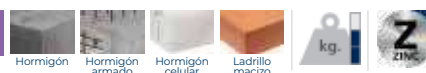

CÓDIGO	MEDIDA	€/100	Ø BROCA	UD. MIN. VENTA		
TAME05030	M5 x 30 Ø5	14,379	5	200	100	4.500
TAME06032	M6 x 32 Ø6	16,137	6	200	100	2.400
TAME08038	M8 x 38 Ø8	27,043	8	200	100	1.200
TAME08060	M8 x 60 Ø8	37,420	8	100	50	600
TAME10060	M10 x 60 Ø10	43,530	10	50	50	600

Blíster

CÓDIGO	MEDIDA	€/BOLSA	PCS	BOLSAS
BZTAME06032	M6 x 32 Ø6	3,216	4	20
BZTAME08038	M8 x 38 Ø8	3,216	4	20
BZTAME08060	M8 x 60 Ø8	3,216	4	20
BZTAME10060	M10 x 60 Ø10	3,216	4	20

AN-CU

Anclaje metálico tipo cuña. Homologado ETE



02 Info. Técnica
P. 391

MACIZOS

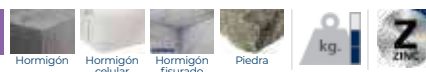

CÓDIGO	MEDIDA	€/100	Ø BROCA		
ANCU06040	6 x 40 Ø6	29,149	6	100	1.200
ANCU06070	6 x 70 Ø6	43,747	6	100	1.200



TC-MA

Taco clavable metálico con punta de acero



METAL

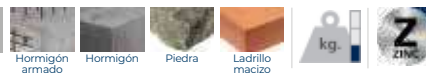

CÓDIGO	MEDIDA	€/100	Ø BROCA		
TCMA05022	5 x 22 Ø5	16,953	5	100	2.400
TCMA06030	6 x 30 Ø6	25,407	6	100	2.400
TCMA06040	6 x 40 Ø6	28,523	6	100	1.200
TCMA06050	6 x 50 Ø6	32,803	6	100	1.200

Anclaje de acero con aletas para cargas altas

AC

02 Info
Técnica
P. 393

MACIZOS

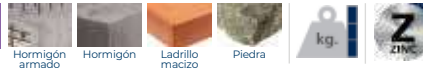

CÓDIGO	MEDIDA	€/100	LONGITUD CÁPSULA	UD. MIN. VENTA		
AACCA06	M6 x 40 Ø10	34,343	40	-	50	1.200
AACCA08	M8 x 50 Ø14	52,361	50	100	50	600
AACCA10	M10 x 60 Ø16	71,543	60	100	50	300
AACCA12	M12 x 80 Ø20	135,780	80	50	25	300
AACCA16	M16 x 100 Ø25	356,807	100	20	10	120

AC-CA

Cápsula



02 Info
Técnica
P. 393

INOXIDABLE

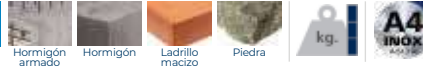

CÓDIGO	MEDIDA	€/100	LONGITUD CÁPSULA		
AACCI06	M6 x 40 Ø10	427,496	40	50	1.200
AACCI08	M8 x 50 Ø14	775,140	50	50	600
AACCI10	M10 x 60 Ø16	895,663	60	25	300
AACCI12	M12 x 80 Ø20	1.604,667	80	10	120

AC-CI

Cápsula. Inoxidable A4



02 Info
Técnica
P. 393

MACIZOS

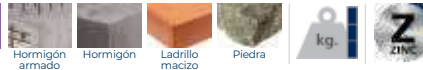

CÓDIGO	MEDIDA	€/100	LONGITUD CÁPSULA		
AACTO06	M6 x 40 Ø10	52,960	40	50	600
AACTO08	M8 x 50 Ø14	96,527	50	50	300
AACTO10	M10 x 60 Ø16	140,375	60	50	200
AACTO12	M12 x 80 Ø20	268,729	80	25	100
AACTO16	M16 x 125 Ø25	611,917	100	10	30

AC-TO

Tornillo 6.8



02 Info
Técnica
P. 394

MACIZOS

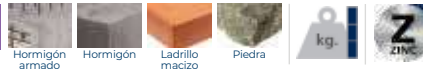

CÓDIGO	MEDIDA	€/100	LONGITUD CÁPSULA		
AACES06	M6 x 40 Ø10	72,417	40	50	600
AACES08	M8 x 50 Ø14	107,550	50	50	300
AACES10	M10 x 60 Ø16	160,170	60	50	200
AACES12	M12 x 80 Ø20	321,253	80	25	100

AC-ES

Espárrago



02 Info
Técnica
P. 394

MACIZOS

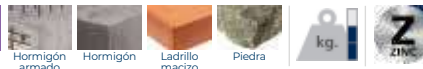

CÓDIGO	MEDIDA	€/100	APERTURA GANCHO		
AACGA06	M6 x 40 Ø10	110,880	10	50	600
AACGA08	M8 x 50 Ø14	154,400	11	50	300
AACGA10	M10 x 60 Ø16	233,967	14	50	100
AACGA12	M12 x 80 Ø20	405,437	18	25	50

AC-GA

Gancho



02 Info
Técnica
P. 394

MACIZOS

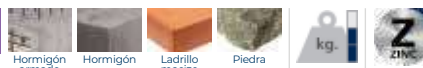

CÓDIGO	MEDIDA	€/100	Ø OJO		
AACAR06	M6 x 40 Ø10	106,210	10	50	600
AACAR08	M8 x 50 Ø14	142,907	12	50	300
AACAR10	M10 x 60 Ø16	219,120	14	50	200
AACAR12	M12 x 80 Ø20	397,440	17	25	100

AC-AR

Argolla



ZA

Anclaje para cargas medias-altas en materiales macizos o huecos

ZA-CA

Cápsula



02 P. 392 Info. Técnica

MACIZOS



CÓDIGO	MEDIDA	€/100	LONGITUD CÁPSULA		
AZAMC06	M6 x 48 Ø12	131,023	48	100	1.200
AZAMC08	M8 x 50 Ø14	151,803	50	100	600
AZAMC10	M10 x 58 Ø16	195,423	58	50	300
AZAMC12	M12 x 72 Ø20	313,450	72	25	300
AZAMC16	M16 x 107 Ø25	664,376	107	25	150

ZA-TO

Tornillo



02 P. 392 Info. Técnica

MACIZOS



CÓDIGO	MEDIDA	€/100	LONGITUD CÁPSULA		
AZAMT06	M6 x 50 Ø12	169,240	50	100	600
AZAMT08	M8 x 60 Ø14	201,850	60	100	400
AZAMT10	M10 x 80 Ø16	287,720	80	50	200
AZAMT12	M12 x 100 Ø20	491,764	100	25	100
AZAMT16	M16 x 140 Ø25	1.059,580	140	25	50

ZA-TL

Tornillo largo



02 P. 392 Info. Técnica

MACIZOS



CÓDIGO	MEDIDA	€/100	MEDIDA TORNILLO		
ZT06L10	M6 x 60 Ø12	179,162	60	100	600
ZT06L30	M6 x 80 Ø12	190,287	80	100	600
ZT08L15	M8 x 70 Ø14	235,930	70	100	400
ZT08L35	M8 x 90 Ø14	245,050	90	100	400
ZT08L45	M8 x 100 Ø14	266,100	100	100	300
ZT10L10	M10 x 70 Ø16	376,520	70	50	200
ZT10L30	M10 x 90 Ø16	377,860	90	50	200
ZT10L50	M10 x 110 Ø16	385,520	110	50	200
ZT10L80	M10 x 140 Ø16	421,877	140	50	150
ZT12L15	M12 x 90 Ø20	570,737	90	25	100
ZT12L45	M12 x 120 Ø20	606,664	120	25	50
ZT12L65	M12 x 140 Ø20	643,747	140	25	100

ZA-PR

Tornillo largo + prolongador



02 P. 392 Info. Técnica

MACIZOS



CÓDIGO	MEDIDA	€/100	LONGITUD PROLONGADOR		
ZP06C40	M6 x 90 Ø12	362,687	40	100	400
ZP08C15	M8 x 70 Ø14	366,493	15	100	200
ZP08C45	M8 x 100 Ø14	424,020	45	100	300
ZP10C50	M10 x 110 Ø16	613,260	50	50	100
ZP10C80	M10 x 140 Ø16	704,723	80	50	100
ZP12C15	M12 x 90 Ø20	755,260	15	25	100
ZP12C65	M12 x 140 Ø20	949,287	65	25	50

ZA-ES

Espárrago



02 P. 392 Info. Técnica

MACIZOS



CÓDIGO	MEDIDA	€/100	MEDIDA TORNILLO		
AZAME06	M6 x 60 Ø12	176,475	60	100	600
AZAME08	M8 x 70 Ø14	220,202	70	100	400
AZAME10	M10 x 100 Ø16	310,467	100	50	200
AZAME12	M12 x 120 Ø20	558,290	120	25	100
AZAME16	M16 x 140 Ø25	1.227,513	140	25	50

Anclaje para cargas medias-altas en materiales macizos o huecos

ZA

02 Info
Técnica
p. 393

MACIZOS



CÓDIGO	MEDIDA	€/100	APERTURA GANCHO		
AZAMG06	M6 x 45 Ø12	164,447	10	50	600
AZAMG08	M8 x 50 Ø14	231,923	13	50	300
AZAMG10	M10 x 56 Ø16	325,888	14	25	150
AZAMG12	M12 x 70 Ø20	531,764	22	25	100

ZA-GA

Gancho



02 Info
Técnica
p. 393

MACIZOS



CÓDIGO	MEDIDA	€/100	APERTURA GANCHO		
AZAMGF006	M6 x 45 Ø12	237,900	10	50	600
AZAMGF008	M8 x 50 Ø14	345,540	11	50	300
AZAMGF010	M10 x 56 Ø16	459,943	14	25	150
AZAMGF012	M12 x 70 Ø20	746,547	18	25	75

ZA-GF

Gancho forjado



02 Info
Técnica
p. 393

MACIZOS



CÓDIGO	MEDIDA	€/100	Ø OJO		
AZAMA06	M6 x 45 Ø12	164,447	10	50	600
AZAMA08	M8 x 50 Ø14	231,923	13	50	300
AZAMA10	M10 x 56 Ø16	325,888	14	25	150
AZAMA12	M12 x 70 Ø20	531,764	22	25	100

ZA-AR

Argolla



02 Info
Técnica
p. 393

MACIZOS



CÓDIGO	MEDIDA	€/100	Ø OJO		
AZAMAF006	M6 x 45 Ø12	236,713	10	50	600
AZAMAF008	M8 x 50 Ø14	319,313	12	50	300
AZAMAF010	M10 x 56 Ø16	424,610	14	25	150
AZAMAF012	M12 x 70 Ø20	679,300	17	25	100

ZA-AF

Argolla forjada



HI

Anclaje antigiro para cargas altas

HI-CA

Cápsula



MACIZOS

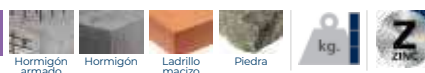

CÓDIGO	MEDIDA	€/100	LONGITUD CÁPSULA		
AHICA0645	M6 x 45 Ø12	82,680	45	100	1.200
AHICA0855	M8 x 55 Ø14	90,427	55	50	600
AHICA1065	M10 x 65 Ø16	115,633	65	50	300
AHICA1275	M12 x 75 Ø20	155,200	75	25	150
AHICA1690	M16 x 90 Ø24	311,607	90	10	60

HI-CI

Cápsula. Inoxidable A2



INOXIDABLE

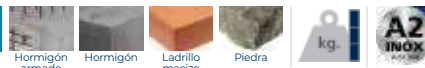

CÓDIGO	MEDIDA	€/100	LONGITUD CÁPSULA		
AHICI0645	M6 x 45 Ø12	600,257	45	100	600
AHICI0855	M8 x 55 Ø14	800,887	55	50	600
AHICI1065	M10 x 65 Ø16	1.069,243	65	50	300

HI-TO

Tornillo 8.8



MACIZOS

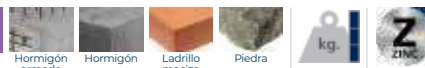

CÓDIGO	MEDIDA	€/100	LONGITUD CÁPSULA		
AHITO0645	M6 x 45 Ø12	110,017	45	100	600
AHITO0855	M8 x 55 Ø14	135,317	55	50	300
AHITO1065	M10 x 65 Ø16	191,233	65	50	200
AHITO1275	M12 x 75 Ø20	291,127	75	25	100
AHITO1690	M16 x 90 Ø24	539,700	90	10	40

HI-GA

Gancho



MACIZOS

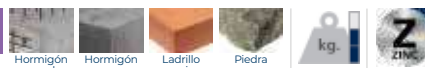

CÓDIGO	MEDIDA	€/100	APERTURA GANCHO		
AHIGA0645	M6 x 45 Ø12	158,913	10	100	400
AHIGA0855	M8 x 55 Ø14	220,697	11	50	300
AHIGA1065	M10 x 65 Ø16	327,213	14	50	100
AHIGA1275	M12 x 75 Ø20	508,133	18	25	75
AHIGA1690	M16 x 90 Ø24	989,650	19	10	30

HI-AR

Argolla



MACIZOS



CÓDIGO	MEDIDA	€/100	Ø OJO		
AHIAR0645	M6 x 45 Ø12	159,017	10	100	400
AHIAR0855	M8 x 55 Ø14	200,428	12	50	300
AHIAR1065	M10 x 65 Ø16	275,266	14	50	200
AHIAR1275	M12 x 75 Ø20	455,297	17	25	75
AHIAR1690	M16 x 90 Ø24	992,637	23	10	30

Anclaje metálico para fijar marcos de puertas y ventanas

EPS

Info
Técnica
P. 395

MULTIMATERIAL



CÓDIGO	ØBROCA X LONGITUD	€/100		ESPESES MÁX. A FIJAR		
EPS6072	M6 x 72 Ø10	61,833	PZ3	40	100	600
EPS6092	M6 x 92 Ø10	74,803	PZ3	60	100	600
EPS6112	M6 x 112 Ø10	82,337	PZ3	80	100	200
EPS6132	M6 x 132 Ø10	92,493	PZ3	100	100	200
EPS6152	M6 x 152 Ø10	104,853	PZ3	120	100	400
EPS6182	M6 x 182 Ø10	133,207	PZ3	150	100	300



Taco elástico para la fijación de rastreles

TRA

Info
Técnica
P. 395

MACIZOS



CÓDIGO	ØBROCA X LONGITUD	€/100	ESPESES MÁX. A FIJAR		
TRA6050	6 x 50 Ø6	17,537	20	200	2.400
TRA6060	6 x 60 Ø6	18,290	30	200	1.200
TRA6080	6 x 80 Ø6	20,993	50	200	1.200
TRA8070	8 x 70 Ø8	28,830	30	100	1.200
TRA8090	8 x 90 Ø8	34,423	50	100	600
TRA8110	8 x 110 Ø8	40,723	70	100	600
TRA8130	8 x 130 Ø8	50,963	90	100	600
TRA8150	8 x 150 Ø8	57,137	110	100	600



Blíster

CÓDIGO	MEDIDA	€/BOLSA	PCS	BOLSAS
BZTRA6050	6 x 50 Ø6	3,216	10	15
BZTRA6060	6 x 60 Ø6	3,216	10	15
BZTRA6080	6 x 80 Ø6	3,216	10	15
BZTRA8070	8 x 70 Ø8	3,216	10	15
BZTRA8090	8 x 90 Ø8	4,463	10	15
BZTRA8110	8 x 110 Ø8	4,463	10	12
BZTRA8130	8 x 130 Ø8	4,463	8	12
BZTRA8150	8 x 150 Ø8	4,463	8	12

Anclaje para fachadas ventiladas

AV

INOXIDABLE

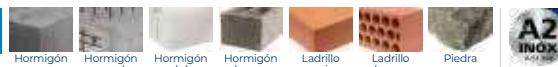

CÓDIGO	MEDIDA	€/100		
AVR08120	M8 x 120 Ø8	319,140	100	600
AVR08150	M8 x 150 Ø8	353,937	100	600
AVR10120	M10 x 120 Ø10	399,093	100	400
AVR10150	M10 x 150 Ø10	456,713	100	200
AVR10180	M10 x 180 Ø10	508,140	100	200

AVR

Roscado



INOXIDABLE



CÓDIGO	MEDIDA	€/100		
AVC08120	8 x 120 Ø8	403,750	100	400
AVC08150	8 x 150 Ø8	460,750	100	-
AVC10120	10 x 120 Ø10	566,103	100	400
AVC10150	10 x 150 Ø10	648,407	100	200
AVC10180	10 x 180 Ø10	732,023	100	200

AVC

Corrugado



ANFA

Anclaje para andamios y fachadas

AN-23

Diámetro de ojo 23 mm



MULTIMATERIAL

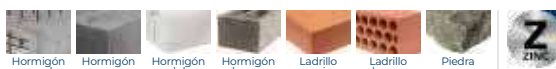

CÓDIGO	MEDIDA	€/100	Ø TACO	PROFUNDIDAD MÍN. DE TALADRO	PROFUNDIDAD MÍN. DEL ANCLAJE	Ø OJO		
ANFA2309	12 x 90 Ø14-Ø16	197,567	TCSO Ø14 o Ø16	90	100	23	20	120
ANFA2312	12 x 120 Ø14-Ø16	211,590	TCSO Ø14 o Ø16	120	130	23	20	80
ANFA2316	12 x 160 Ø14-Ø16	256,447	TCSO Ø14 o Ø16	160	170	23	20	60
ANFA2319	12 x 190 Ø14-Ø16	288,290	TCSO Ø14 o Ø16	190	200	23	20	60
ANFA2323	12 x 230 Ø14-Ø16	332,060	TCSO Ø14 o Ø16	230	240	23	20	40
ANFA2330	12 x 300 Ø14-Ø16	450,746	TCSO Ø14 o Ø16	300	310	23	10	20
ANFA2335	12 x 350 Ø14-Ø16	505,823	TCSO Ø14 o Ø16	350	360	23	10	-

AN-51

Diámetro de ojo 51 mm



MULTIMATERIAL

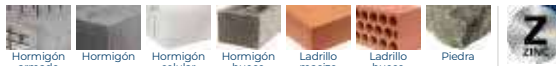

CÓDIGO	MEDIDA	€/100	Ø TACO	PROFUNDIDAD MÍN. DE TALADRO	PROFUNDIDAD MÍN. DEL ANCLAJE	Ø OJO		
ANFA5114	12 x 140 Ø14-Ø16	340,137	TCSO Ø14 o Ø16	140	150	51	20	60
ANFA5116	12 x 160 Ø14-Ø16	371,313	TCSO Ø14 o Ø16	160	170	51	20	40
ANFA5120	12 x 200 Ø14-Ø16	480,910	TCSO Ø14 o Ø16	200	210	51	20	40
ANFA5124	12 x 240 Ø14-Ø16	529,759	TCSO Ø14 o Ø16	240	250	51	20	40

AN-50 CT

Diámetro de ojo 50 mm + cápsula Zamak M10



MULTIMATERIAL

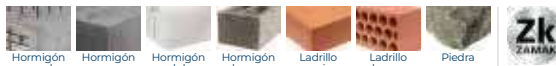

CÓDIGO	MEDIDA	€/100	PROFUNDIDAD MÍN. DE TALADRO	PROFUNDIDAD MÍN. DEL ANCLAJE	Ø OJO		
ANFAZ5021	M10 x 210 Ø16	1.143,897	55	120	50	10	20

TC-SO 2

Taco de nylon. 2 alas



MULTIMATERIAL



CÓDIGO	MEDIDA	€/100		
TCSO14075	14 x 75 Ø14	27,950	20	240
TCSO14100	14 x 100 Ø14	36,037	20	240

TC-SO 8

Taco de nylon. 8 alas



MULTIMATERIAL

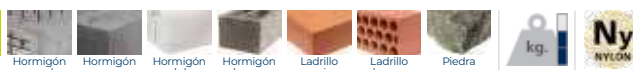

CÓDIGO	MEDIDA	€/100		
TCSO14130	14 x 130 Ø14	67,227	20	240
TCSO14160	14 x 160 Ø14	75,737	20	120
TCSO16140	16 x 140 Ø16	148,337	20	120
TCSO16160	16 x 160 Ø16	157,953	20	80
TCSO16200	16 x 200 Ø16	163,083	20	60
TCSO16240	16 x 240 Ø16	185,413	20	40

AN-TA

Tapón tapa-agujeros



MULTIMATERIAL



CÓDIGO	MEDIDA	€/100	PROFUNDIDAD MÍN. DE TALADRO	PROFUNDIDAD MÍN. DEL ANCLAJE		
ANFATA37B	13 x 37	27,027	33	130	100	600
ANFATA70B	13 x 70	32,557	33	180	100	300

























FIJACIONES QUÍMICAS



Tabla de selección

									
Polyester Universal	Polyester PLUS	Polyester PLUS sin estireno	Polyester PLUS sin estireno. Piedra	Vinylester	Vinylester sin estireno	Resina híbrida sin estireno	Resina híbrida sin estireno. winter	Epoxy puro 1:1	Epoxy puro 3:1
MO-PU	MO-P+	MO-PS+	MO-PSP+	MO-V	MO-VS	MO-H	MO-HW	MOPURE	MOPUR3

 opción 1						•	•	•	•
 opción 7	•	•	•	•	•				
					•	•		•	•
			•	•	•	•	•		
									•
						•	•	•	
						•	•		•
								•	
	•	•	•	•	•	•	•	•	•
	•	•	•	•	•	•	•	•	•
						•	•		•
			•	•	•	•	•		
	•	•	•	•	•	•	•	•	•
						•	•	•	•
						•	•	•	•
	•	•	•	•	•	•	•	•	•
	•	•	•	•	•	•	•	•	•
	•	•	•	•	•	•	•	•	•
	•	•	•	•	•	•	•	•	•
	•	•	•	•	•	•	•	•	•
	•	•	•	•	•	•	•	•	•
							•		
	•	•	•	•	•	•	•	•	•

Fijaciones químicas

MO

QUÍMICOS

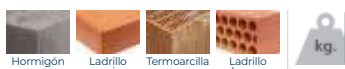

CÓDIGO	MEDIDA	€/PC	
MOPU300	300 ml.	15,203	12
MOPU410	410 ml.	18,383	12



M8-M24

MO-PU

Polyester universal. Homologado ETE Opt.7



QUÍMICOS

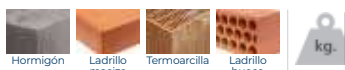

CÓDIGO	MEDIDA	€/PC	
MOP300	300 ml.	15,987	12
MOP410	410 ml.	18,887	12



M8-M24

MO-P+

Polyester PLUS. Homologado ETE Opt.7



QUÍMICOS



CÓDIGO	MEDIDA	€/PC	
MOP5300	300 ml.	18,313	12
MOP5410	410 ml.	22,857	12

KIT MO-PS+

MOP5300EP	300 ml.	30,393	1
-----------	---------	--------	---

Contenido del KIT:

• Cartucho MOP5300(300 ml.) - x1



• Espárragos MOP5300(10 (M8-M24) - x4



Ver video



¿Sabes hasta cuándo se puede manipular un anclaje químico ya aplicado?

El novedoso TESTIGO DE MANIPULADO incorporado en el MO-PS+ se trata de una tecnología única en el mercado. La resina cambia de color cuando inicia el proceso de curado, de azul a gris. Mientras se mantiene el tono azulado, el espárrago o varilla aplicada se puede manipular.



M8-M24

MO-PS+

Polyester PLUS sin estireno con testigo de manipulado. Homologado ETE Opt.7



QUÍMICOS

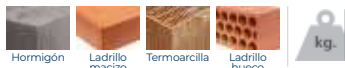

CÓDIGO	MEDIDA	€/PC	
MOPSP300	300 ml.	19,229	12
MOPSP410	410 ml.	24,000	12



M8-M24

MO-PSP+

Polyester PLUS sin estireno color piedra. Homologado ETE Opt.7



MO

Fijaciones químicas

MO-V

Vinylester.
Homologado
ETE Opt.7.



CÓDIGO	MEDIDA	€/PC	
MOV300	300 ml.	19,427	12
MOV410	410 ml.	23,547	12

QUÍMICOS Hormigón



M8-M24

MO-VS

Vinylester
sin estireno.
Homologado
ETE Opt.7



CÓDIGO	MEDIDA	€/PC	
MOV5300	300 ml.	22,930	12
MOV5410	410 ml.	27,857	12

QUÍMICOS Hormigón

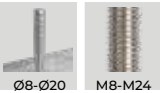

Ø8-Ø20 M8-M24

MO-H

Híbrida sin estireno.
Homologado
ETE Opt.1



CÓDIGO	MEDIDA	€/PC	
MOH300	300 ml.	27,520	12
MOH410	410 ml.	32,013	12

QUÍMICOS Hormigón Hormigón fisurado Ladrillo macizo Hormigón armado Ladrillo hueco Termoarcilla



Ø8-Ø25 Ø8-Ø32 M8-M30

MO-HW

Híbrida sin estireno
versión WINTER.
Homologado
ETE Opt.1



CÓDIGO	MEDIDA	€/PC	
MOHW300	300 ml.	28,893	12
MOHW410	410 ml.	33,910	12

QUÍMICOS Hormigón Hormigón fisurado Ladrillo macizo Hormigón armado Ladrillo hueco Termoarcilla



Ø8-Ø32 M8-M30

QUÍMICOS

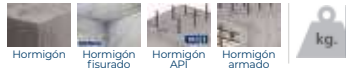

CÓDIGO	MEDIDA	€/PC	
MOPURE600	600 ml.	79,380	12



MOPURE

Epoxy Puro 1:1.
Homologado ETE Opt.1



QUÍMICOS

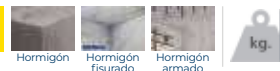

CÓDIGO	MEDIDA	€/PC	
MOPUR30385	385 ml.	55,803	12
MOPUR30585	585 ml.	74,730	12



MOPUR3

Epoxy puro 3:1.
Homologado ETE Opt.1



INDEXmor CLOUD

SOFTWARE ONLINE PARA CALCULO DE MORTEROS QUÍMICOS

El software permite realizar el cálculo online de cuántos cartuchos serán necesarios utilizar en función de los parámetros introducidos, tanto en ladrillo como en hormigón (varilla métrica y barra corrugada).

Parámetros en Hormigón:

- Selección de elemento a instalar (Varilla métrica o barra corrugada).
- Número de taladros a rellenar.
- Selección de métrica (M8 - M32).
- Profundidad del taladro.
- Aprovechamiento del cartucho (óptima, buena, pobre).

Parámetros en Ladrillo:

- Número de taladros a rellenar.
- Selección de métrica (M8 - M12).
- Posibilidad de incluir tamiz roscado en el cálculo.

Prestaciones:

- Software 100% online.
- Facilidad de uso. Responsive design.
- Multilingüe: disponible en castellano, inglés, francés, alemán y portugués.



MO-PIS

Pistolas aplicadoras

MO-PIS

Pistolas aplicadoras



MOPISTO



MOPISPR



MOPISSI



MOPISPUR6



MOPISNEU



MOPISP3

CÓDIGO	MEDIDA	€/PC	
MOPISTO	Manual / Manuel 410 ml.	52,580	1
MOPISPR	Profesional / Professional / Professionnel 410 ml.	120,237	1
MOPISSI	Silicona / Silicone/ 300 ml.	32,727	1
MOPISPUR6	MOPURE600 - 600 ml.	75,677	1
MOPISNEU	Neumática / Pneumatic / Pneumatique	1.592,203	1
MOPISP3385	MOPUR3 - 385 ml.	135,400	1
MOPISP3585	MOPUR3 - 585 ml.	153,763	1

MO-TN

Tamiz de plástico



CÓDIGO	MEDIDA	€/100	UD. MIN. VENTA		
MOTN12050	12 x 50	39,110	24	12	2.256
MOTN12080	12 x 80	34,733	24	12	2.256
MOTN15085	15 x 85	34,393	24	12	1.500
MOTN15130	15 x 130	40,567	24	12	1.008
MOTN20085	20 x 85	39,137	24	12	1.008

Bolsa autoservicio

CÓDIGO	MEDIDA	€/BOLSA	PCS	BOLSAS
LSMOTN12050	12 x 50	2,773	4	7
LSMOTN15085	15 x 85	2,763	4	6
LSMOTN20085	20 x 85	2,440	2	6

MO-TR

Tamiz roscado



CÓDIGO	MEDIDA	€/100		
MOTRO08	M8 x 80 Ø12	180,438	12	540
MOTRO10	M10 x 80 Ø14	241,719	12	288
MOTRO12	M12 x 80 Ø16	292,668	12	288

MO-AC

Cánulas mezcladoras y varios



MOBOMBA
Bomba sopladora



MORCAPU
Cánula mezcladora (385-585-600 ml)

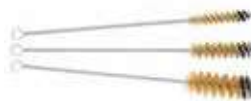

MORCEPKIT
Kit de 3 cepillos



MO-TL
Tamiz largo recortable para fijación en cubierta teja + rasillón



MORCANU
Cánula mezcladora (300-410 ml)



MO-PC
Extensor de cánula para fijaciones químicas

CÓDIGO	MEDIDA	€/PC		
MOBOMBA	Bomba Sopladora / Blow pump / Pompe soufflante	18,037	1	1
MORCANU	170 ml. - 300 ml. - 410 ml.	0,950	12	1.008
MORCAPU	Cánula/ Nozzle/ Canule/ Cánula (385-585-600 ml)	1,457	12	24
MORCEPKIT	Kit Cepillo / Brush / Écouvillon (1 x Ø14 - 1 x Ø20 - 1 x Ø27)	74,443	1	1
MOTL16330 NEW	16 x 330	202,997	-	10
MOPC185 NEW	185 mm	3,587	-	1

MO-ES

Espárrago roscado



CÓDIGO	MEDIDA	€/100		
MOES06070	M6 x 70 Ø6	64,373	12	540
MOES08110	M8 x 110 Ø8	108,943	12	288
MOES10115	M10 x 115 Ø10	144,697	12	144
MOES12110	M12 x 110 Ø12	192,790	12	144

Bolsa autoservicio

CÓDIGO	MEDIDA	€/BOLSA	PCS	BOLSAS
LSMOES06070	M6 x 70 Ø6	4,284	4	10
LSMOES08110	M8 x 110 Ø8	6,111	4	7
LSMOES10115	M10 x 115 Ø10	7,540	4	6
LSMOES12110	M12 x 110 Ø12	9,470	4	6

MO-TM

Tamiz metálico





CÓDIGO	MEDIDA	€/100	
MOTM12100	12 x 1000 Ø11	1.996,950	10
MOTM16100	16 x 1000 Ø14	2.261,427	10
MOTM22100	22 x 1000 Ø21	2.656,227	5

Resina de epoxi-acrilato, cuarzo y catalizador. Homologado ETE Opt. 8

CA-QU



CÓDIGO	MEDIDA	€/100		
CAQU008	8 x 80 Ø10	211,290	10	500
CAQU010	10 x 90 Ø12	216,145	10	500
CAQU012	12 x 110 Ø14	225,362	10	200
CAQU016	16 x 125 Ø18	250,556	10	200
CAQU020	20 x 170 Ø25	509,803	6	60
CAQU024	24 x 210 Ø28	596,894	6	60
CAQU030	30 x 280 Ø35	1.064,380	6	30

• Medidas sin homologar

CA-QU



Resina de epoxi-acrilato, cuarzo y catalizador. Homologado ETE Opción 8

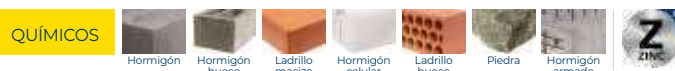

Espárragos con tuerca y arandela para anclaje químico

EQ





CÓDIGO	MEDIDA	€/100		
EQAC08110	M8 x 110	94,133	10	240
EQAC10130	M10 x 130	148,477	10	120
EQAC10190	M10 x 190	220,900	10	30
EQAC12160	M12 x 160	220,690	10	120
EQAC12220	M12 x 220	340,703	10	30
EQAC16190	M16 x 190	426,213	10	40
EQAC16250	M16 x 250	614,720	10	30
EQAC20260	M20 x 260	938,810	6	12
EQAC20350	M20 x 350	1.351,780	6	-
EQAC24300	M24 x 300	1.426,857	6	12
EQAC24380	M24 x 380	2.235,387	6	-
EQAC30330	M30 x 330	2.694,880	6	12

EQ-AC

Cincado





CÓDIGO	MEDIDA	€/100		
EQ8808110	M8 x 110	94,638	10	240
EQ8810130	M10 x 130	155,903	10	120
EQ8812160	M12 x 160	229,797	10	60
EQ8816190	M16 x 190	452,723	6	24
EQ8820260	M20 x 260	973,053	6	24
EQ8824300	M24 x 300	1.608,033	6	12

EQ-8.8

Cincado 8.8



CÓDIGO	MEDIDA	€/100		
EQA208110	M8 x 110	266,243	10	240
EQA210130	M10 x 130	463,153	10	120
EQA212160	M12 x 160	767,590	10	120
EQA216190	M16 x 190	1.590,427	10	40
EQA220260	M20 x 260	3.039,723	6	12
EQA224300	M24 x 300	4.857,647	6	12
EQA230330	M30 x 330	8.153,597	6	12

EQ-A2

Inoxidable A2

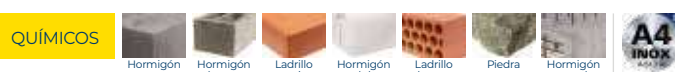

CÓDIGO	MEDIDA	€/100		
EQA408110	M8 x 110	338,743	10	240
EQA410130	M10 x 130	615,293	10	120
EQA412160	M12 x 160	1.058,413	10	120
EQA416190	M16 x 190	2.073,420	10	40
EQA420260	M20 x 260	5.048,270	6	12
EQA424300	M24 x 300	8.320,540	6	12
EQA430330	M30 x 330	14.677,490	6	12

EQ-A4

Inoxidable A4



Tabla de selección





	MSPRB290	MSPRG290	MSPRM290	MSPRN290	MSTR290	MSSF290
	•	•	•	•		
	•	•	•	•		•
	•	•	•	•	•	•
	•	•	•	•	•	•
	•	•	•	•		
	•	•	•	•	•	•
	•	•	•	•	•	•
	•	•	•	•	•	•
	•	•	•	•	•	•
	•	•	•	•	•	•
	•	•	•	•	•	•
	•	•	•	•	•	•
	•	•	•	•	•	•
	•	•	•	•	•	•
	300 %	300 %	300 %	300 %	250 %	200 %
	150 kg/10 cm ²	150 kg/10 cm ²	150 kg/10 cm ²	150 kg/10 cm ²	140 kg/10 cm ²	430 kg/10 cm ²
	•	•	•	•	•	•
	•	•	•	•	•	•
	•	•	•	•	•	•
					•	
						•

Adhesivos Hybrid MS Polymer

MS

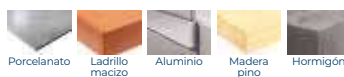
QUÍMICOS



CÓDIGO	MEDIDA	COLOR	€/PC	
MSPRB290	290 ml. (Blanco)	BLANCO	11,033	12
MSPRG290	290 ml. (Gris)	GRIS	11,033	12
MSPRM290	290 ml. (Marrón)	MARRÓN	11,033	12
MSPRN290	290 ml. (Negro)	NEGRO	11,033	12

APLICACIONES

- Pegado y sellado en construcción: repisas, remates en tejado, canalones, cubiertas, juntas de marcos o estructuras sometidas a vibraciones. Sellado y pegado en industria y automóvil.
- Relleno de grietas.
- Sellado de juntas de dilatación, cisternas, contenedores y otros elementos de aluminio.
- Producto certificado para el uso en la industria de procesamiento de alimentos (Certificado ISEGA).
- Adhesión a todo tipo de materiales: hormigón, madera, metal, corcho, aluminio, PVC, cobre, ladrillo, piedra, porcelana... No recomendado para Polietileno (PE), Polipropileno (PP) y Politetrafluoroetileno (PTFE).
- En caso de no conocer el material base se deberán realizar unas pruebas previas para garantizar el buen funcionamiento del producto.

MS-PR

Adhesivo MS Profesional



QUÍMICOS

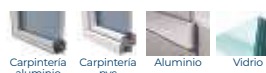

CÓDIGO	MEDIDA	COLOR	€/PC	
MSTR290	290 ml. (Transparente)	TRANSPARENTE	16,555	12

APLICACIONES

- Incoloro. Adecuado para el pegado de vidrio, cristal, acrílico, PVC, porcelana, cerámica y otros elementos transparentes en interior o exterior.
- Fijación de materiales con una unión transparente o visible.
- Apto para aplicación sobre superficies húmedas.
- Adhesión a todo tipo de materiales (hormigón, madera, metal, corcho, aluminio, PVC, cobre, ladrillo, piedra, porcelana...). No recomendado para Polietileno (PE), Polipropileno (PP) y Politetrafluoroetileno (PTFE).
- En caso de no conocer el material base se deberán realizar unas pruebas previas para garantizar el buen funcionamiento del producto.
- Apto para montar y pegar.

MS-TR

Adhesivo MS Transparente



QUÍMICOS

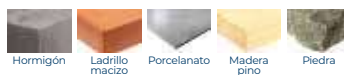

CÓDIGO	MEDIDA	COLOR	€/PC	
MSSF290	290 ml. (Blanco)	BLANCO	12,539	12

APLICACIONES

- Especialmente indicado para el pegado y conexión rápida de elementos pesados sin fijaciones adicionales. Triplica las prestaciones de agarre de otros adhesivos.
- Apto para usar en interior y exterior. Resistente a rayos UV.
- Adhesión a todo tipo de materiales: hormigón, madera, metal, corcho, aluminio, PVC, cobre, ladrillo, piedra, porcelana... No recomendado para Polietileno (PE), Polipropileno (PP) y Politetrafluoroetileno (PTFE).
- En caso de no conocer el material base se deberán realizar unas pruebas previas para garantizar el buen funcionamiento del producto.

MS-SF

Adhesivo MS Superfast High Tack



Tabla de selección

	SI-PR					SI-PRS		SI-UNI					SI-UNS		SE-ACR	
	SIPRB280	SIPRG280	SIPRM280	SIPRN280	SIPRT280	SIPRSB280	SIPRST280	SIUNIB280	SIUNIG280	SIUNIM280	SIUNIN280	SIUNIT280	SIUNSB280	SIUNST280	SEACRB280	SEACRG280
	•	•	•	•	•	•	•	•	•	•	•	•	•	•	•	•
	•	•	•	•	•	•	•							•	•	
								•	•	•	•	•	•			
	•	•	•	•	•	•	•	•	•	•	•	•	•	•	•	•
	•	•	•	•	•	•	•	•	•	•	•	•	•	•	•	•
	•	•	•	•	•	•	•	•	•	•	•	•	•	•	•	•
	•	•	•	•	•	•	•	•	•	•	•	•	•	•	•	•
	•	•	•	•	•	•	•	•	•	•	•	•	•	•	•	•
	•	•	•	•	•	•	•	•	•	•	•	•	•	•	•	•
															•	•
	•	•	•	•	•	•	•	•	•	•	•	•	•	•	•	•
	•	•	•	•	•	•	•							•	•	
	•	•	•	•	•	•	•	•	•	•	•	•	•	•	•	•
	•	•	•	•	•	•	•	•	•	•	•	•	•	•	•	•
					•							•				
							•	•					•	•		
							•	•					•	•		
	•	•	•	•	•											
	•	•	•	•	•	•	•									
															•	•
															•	•

Siliconas

SI

QUÍMICOS



CÓDIGO	MEDIDA	COLOR	€/PC	
SIPRB280	280 ml. (Blanco)	BLANCO	9,833	12
SIPRG280	280 ml. (Gris)	GRIS	9,833	12
SIPRM280	280 ml. (Marrón)	MARRÓN	9,833	12
SIPRN280	280 ml. (Negro)	NEGRO	9,833	12
SIPRT280	280 ml. (Transparente)	TRANSPARENTE	9,833	12

CARACTERÍSTICAS

- Elásticas y flexibles
- Apto para aplicación en ventanas
- Disponible en colores blanco, negro, marrón (RAL 8016), gris (RAL 7030) y transparente
- Multimaterial: aptas para su uso en carpintería de aluminio y PVC, juntas de dilatación, hormigón, ladrillos, piedra, madera, metales y vidrio)
- Certificado A+ sobre emisiones en interiores

QUÍMICOS



CÓDIGO	MEDIDA	COLOR	€/PC	
SIPRSB280	280 ml. (Blanco)	BLANCO	9,833	12
SIPRST280	280 ml. (Transparente)	TRANSPARENTE	9,833	12

CARACTERÍSTICAS

- Contienen fungicidas para evitar la aparición de moho
- Aptas para la aplicación en baños y cocinas
- Elásticas y flexibles
- Aptas para la aplicación en ventanas
- Disponible en color blanco y transparente
- Multimaterial: aptas para su uso en carpintería de aluminio y PVC, juntas de dilatación, hormigón, ladrillos, piedra, madera, metales y vidrio)

QUÍMICOS



CÓDIGO	MEDIDA	COLOR	€/PC	
SIUNIB280	280 ml. (Blanco)	BLANCO	6,700	12
SIUNIG280	280 ml. (Gris)	GRIS	6,700	12
SIUNIM280	280 ml. (Marrón)	MARRÓN	6,700	12
SIUNIT280	280 ml. (Transparente)	TRANSPARENTE	6,700	12

CARACTERÍSTICAS

- Multiusos: apto para su uso en aluminio, cerámica, vidrio y porcelana
- No aptas para materiales porosos, oxidables o atacables por ácidos
- Elásticas y flexibles
- Apto para aplicación en interior y exterior

SI-PR

Silicona Neutra Profesional para materiales lisos y porosos



SI-PRS

Silicona Neutra SANITAR Profesional con propiedades fungicidas



SI-UNI

Silicona acética universal multiusos



SI

Siliconas

SI-UNS

Silicona acética SANITAR universal multiusos con propiedades fungicidas

QUÍMICOS



CÓDIGO	MEDIDA	COLOR	€/PC	
SIUNSB280	280 ml. (Blanco)	BLANCO	6,700	12
SIUNST280	280 ml. (Transparente)	TRANSPARENTE	6,700	12

CARACTERÍSTICAS

- Contienen fungicidas para evitar la aparición de moho
- Aptas para la aplicación en baños y cocinas
- Elásticas y flexibles
- Aptas para la aplicación en ventanas
- Disponible en color blanco y transparente
- Multiusos: Aptas para su uso en aluminio, cerámica, vidrio y porcelana.
- No aptas para materiales porosos, oxidables o atacables por ácidos



SE-ACR

Masilla acrílica para juntas y grietas

QUÍMICOS



CÓDIGO	MEDIDA	COLOR	€/PC	
SEACRB280	280 ml. (Blanco)	BLANCO	4,727	12
SEACRG280	280 ml. (Gris)	GRIS	4,727	12

CARACTERÍSTICAS

- Apta para el sellado de todo tipo de juntas, pequeños agujeros, grietas en fachada, pared, ranuras en cajas de persianas, marcos de puertas y ventanas
- Apta para aplicación en materiales porosos (Hormigón, madera, baldosas de cerámica, placas de yeso) y para la reparación de pequeñas grietas
- Flexible y alta adhesión
- Se puede pintar y barnizar
- Muy fácil de aplicar
- Apto para aplicación en interior y exterior



MS-CA

Cánulas para MS y Siliconas

QUÍMICOS



CÓDIGO	MEDIDA	VÁLIDO PARA	€/BOLSA		
MSCATP	Tapón	MS-PR, MS-T, SI	12,667	1	18
MSCAHT	Ancha	MS-SF	13,273	1	18

Espumas de poliuretano

PU

QUÍMICOS



CÓDIGO	MEDIDA	€/PC	
PUSP750	750 ml.	15,233	12



PU-SP

Espuma de poliuretano multiusos para aplicación con pistola



QUÍMICOS



CÓDIGO	MEDIDA	€/PC	
PUSC750	750 ml.	14,500	12



CÁNULA ECOFLEX

Su novedoso sistema de bloqueo permite conservar y reutilizar el producto varios días, permitiendo no desperdiciar producto y ser más respetuoso con el medioambiente.

PU-SC

Espuma de poliuretano multiusos para aplicación con cánula ECOFLEX



QUÍMICOS



CÓDIGO	MEDIDA	€/PC	
PUTP750	750 ml.	16,067	12



PU-TP

Espuma de poliuretano para aplicación con pistola. Color gris



PU

Espumas de poliuretano

PU-TPR

Espuma de poliuretano para fijación de tejas para aplicación con pistola. Color teja



QUÍMICOS



CÓDIGO	MEDIDA	€/PC	
PUTPR750	750 ml.	16,067	12



PU-FP

Espuma de poliuretano resistente al fuego para aplicación con pistola



QUÍMICOS



CÓDIGO	MEDIDA	€/PC	
PUFP750	750 ml.	25,000	12



PU-FC

Espuma de poliuretano resistente al fuego para aplicación con cánula ECOFLEX



QUÍMICOS



CÓDIGO	MEDIDA	€/PC	
PUFC750	750 ml.	24,167	12



Espumas de poliuretano

PU

QUÍMICOS



CÓDIGO	MEDIDA	€/PC	
PUEP750	750 ml.	22,100	12



CÁNULA ECOFLEX

Su novedoso sistema de bloqueo permite conservar y reutilizar el producto varios días, permitiendo no desperdiciar producto y ser más respetuoso con el medioambiente.

PU-EP

Adhesivo de poliuretano SATE para paneles aislantes y placas de yeso laminado para aplicación con pistola



QUÍMICOS



CÓDIGO	MEDIDA	€/PC	
PUCL500	500 ml.	14,379	12



PU-CL

Limpiador de accesorios para la aplicación de espuma de poliuretano



PU-PI



Pistolas aplicadoras para espuma de poliuretano

QUÍMICOS

PU-PI

Profesional





CÓDIGO	MEDIDA	€/PC		
PUPI01	750 ml.	91,333	1	12

PU-PI 2

Básica



QUÍMICOS

CÓDIGO	MEDIDA	€/PC		
PUPI02	750 ml.	34,833	1	12

PU-CA

Cánula aplicadora para espuma de poliuretano

QUÍMICOS



CÓDIGO	MEDIDA	€/PC		
PUCA01	750 ml.	4,924	1	18



FIJACIONES PLÁSTICAS



T-NUX

Los tacos de nylon universales de alto rendimiento para uso en hormigón y mampostería, son una solución polivalente y profesional. Permiten su instalación con las máximas garantías de seguridad gracias a que cuentan con homologación ETE y a resistencia a fuego.

Su diseño permite que el taco logre adaptarse a cualquier tipo de material base, ya sea en material sólido o hueco. Además, posibilita que la carga se distribuya a lo largo de todo el taco, gracias a una expansión controlada en distintos puntos del material donde se instala.



DISEÑO Y GEOMETRÍA

Collarín de seguridad.
Impide que el taco se cuele por el taladro

Aletas antigiro. Evitan que el anclaje rote sobre sí mismo en el interior del taladro, aportando seguridad adicional a la instalación



Punta polivalente.
Facilita la inserción adaptándose a cualquier material base

Marca de profundidad.
Indica el punto hasta el que introducir el anclaje en el agujero

Zona anudable.
El taco se anuda sobre materiales huecos

CUALIDADES Y VENTAJAS



MÁXIMA VERSATILIDAD. MULTIMATERIAL.

Su diseño permite que el taco logre adaptarse a cualquier tipo de material base, ya sea en materiales macizos o huecos. Especialmente apto para cuando se desconozca el material base donde se realiza la fijación.

MÁXIMAS GARANTÍAS. PRODUCTOS HOMOLOGADOS ACORDE A LOS MÁS ALTOS ESTÁNDARES DE CALIDAD.

- Homologado (ETA 14/0467) para usos no estructurales en hormigón, hormigón aireado, ladrillo macizo, ladrillo hueco y bloque de hormigón (en las medidas Ø8 y Ø10)
- Homologado a resistencia a fuego R30-R120 en hormigón

*El anclaje está homologado cuando se utiliza el taco y el tornillo su conjunto, no por separado. Utilizar anclajes homologados aporta seguridad y calidad al anclaje cumpliendo los más altos estándares de calidad.



APLICACIONES



- Fijación de marcos de ventanas y puertas.
- Puertas de garajes.
- Barandillas.
- Balaustradas.
- Fijación de rejillas.
- Rehabilitación de fachadas.
- Fijación de subestructuras metálicas para fachadas ventiladas.
- Usos exteriores e interiores.
- Fijación de aplacados de piedra para revestimientos de fachada.

FABRICACIÓN 100% INDEX

Esto nos permite asegurar un riguroso control de los procesos, garantizar la máxima calidad en nuestros productos, brindar el mejor servicio y obtener un coste global competitivo.



PRODUCTO DE CALIDAD

El anclaje T-NUX está compuesto de dos elementos de máxima calidad, un taco de nylon de Poliamida 6 y un tornillo (ver diferentes alternativas en la gama. También disponible el taco suelto).



MÁXIMAS PRESTACIONES

La geometría del taco permite que al introducir el tornillo, el taco expanda de una manera uniforme y permita una fijación con unas altas prestaciones de hasta 202 Kg por anclaje (consultar ficha técnica).

GAMA



PRODUCTO	T-NUX A	T-NUX A A4	T-NUX E	T-NUX E A4	T-NUX T	T-FUX E	T-NUX
CABEZA DEL TORNILLO	Avellanada	Avellanada	Hexagonal	Hexagonal	Truss inviolable	Hexagonal sin arandela	Espárrago
RECUBRIMIENTO/MATERIAL DEL TORNILLO	Z	A4 INOX	Z	A4 INOX	Z	Z	-
TIPO DE CABEZA DEL TACO							
CE	✓	✓	✓	✓	✓	✓	
Fire Resistance	✓	✓	✓	✓	✓	✓	

EL RECUBRIMIENTO PERFECTO SEGÚN EL NIVEL DE CORROSIÓN



Material Inoxidable A4: válido para interior y exterior, en zonas costeras o industriales, zonas expuestas a alta contaminación o zonas cercanas a carreteras.



Recubrimiento Cincado: apto para uso en condiciones interiores secas (categoría C1 según la norma ISO 923), por un periodo de 50 años.

Taco de nylon universal de alto rendimiento

02 Info
Técnica
p. 399

MULTIMATERIAL



CÓDIGO	MEDIDA	€/100		ESPESOR MÁX. A FIJAR		
• TNUXA08060	8 x 60 Ø8	50,170	TX30	10	50	600
• TNUXA08080	8 x 80 Ø8	54,913	TX30	10	50	600
• TNUXA08100	8 x 100 Ø8	68,647	TX30	30	50	600
• TNUXA08120	8 x 120 Ø8	78,493	TX30	50	50	300
• TNUXA10060	10 x 60 Ø10	74,357	TX40	10	50	300
TNUXA10080	10 x 80 Ø10	91,413	TX40	10	50	300
TNUXA10100	10 x 100 Ø10	103,283	TX40	30	50	300
TNUXA10120	10 x 120 Ø10	125,253	TX40	50	50	300
TNUXA10140	10 x 140 Ø10	147,840	TX40	70	50	300
TNUXA10160	10 x 160 Ø10	157,793	TX40	90	50	200
TNUXA10180	10 x 180 Ø10	215,587	TX40	110	50	150
TNUXA10200	10 x 200 Ø10	261,357	TX40	130	50	150
TNUXA10230	10 x 230 Ø10	304,760	TX40	160	50	100

• Medidas sin homologar
• Medida sin homologar para fuego

T-NUX A

Cabeza avellanada. Huella TX. Cincado. Homologado ETE



Disponible en varios recubrimientos. Consulte precio y plazo de entrega.

02 Info
Técnica
p. 400

Caja ventana

Bolsa autoservicio

CÓDIGO	MEDIDA	€/BOLSA	PCS	BOLSAS
BZTNXA08080	8 x 80 Ø8	3,216	2	15
BZTNXA08100	8 x 100 Ø8	3,216	2	15
BZTNXA08120	8 x 120 Ø8	3,216	2	15
BZTNXA10080	10 x 80 Ø10	3,216	2	15
BZTNXA10100	10 x 100 Ø10	3,216	2	15
BZTNXA10120	10 x 120 Ø10	3,216	2	15

CÓDIGO	MEDIDA	€/CAJA	PCS	CAJAS
VTNUXA08080	8 x 80 Ø8	5,454	8	8
VTNUXA08100	8 x 100 Ø8	6,817	8	8
VTNUXA10080	10 x 80 Ø10	9,073	8	8
VTNUXA10100	10 x 100 Ø10	10,255	8	8

CÓDIGO	MEDIDA	€/BOLSA	PCS	BOLSAS
LSTNXA08080	8 x 80 Ø8	6,377	10	8
LSTNXA08100	8 x 100 Ø8	7,596	10	8
LSTNXA08120	8 x 120 Ø8	8,360	8	8
LSTNXA10080	10 x 80 Ø10	8,989	8	8
LSTNXA10100	10 x 100 Ø10	6,856	6	6

02 Info
Técnica
p. 400

INOXIDABLE

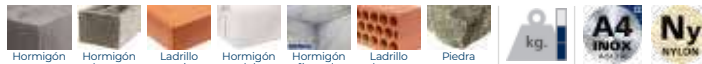

CÓDIGO	MEDIDA	€/100		ESPESOR MÁX. A FIJAR		
• TNXA408080	8 x 80 Ø8	269,183	TX30	10	50	600
• TNXA408100	8 x 100 Ø8	324,590	TX30	30	50	600
• TNXA408120	8 x 120 Ø8	400,986	TX30	50	50	300
TNXA410080	10 x 80 Ø10	342,621	TX40	10	50	300
TNXA410100	10 x 100 Ø10	409,076	TX40	30	50	300
TNXA410120	10 x 120 Ø10	476,397	TX40	50	50	300
TNXA410140	10 x 140 Ø10	564,921	TX40	70	50	300

• Medida sin homologar para fuego

T-NUX A A4

Inoxidable A4. Cabeza avellanada. Huella TX. Homologado ETE



T-NUX E

Cabeza hexagonal. Huella TX. Cincado. Homologado ETE



Disponible en varios recubrimientos. Consulte precio y plazo de entrega.

02 Info
Técnica
p. 400

MULTIMATERIAL

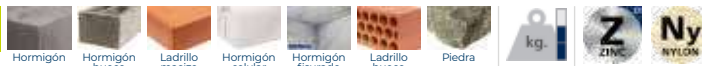

CÓDIGO	MEDIDA	€/100	N° HUELLA	ESPESOR MÁX. A FIJAR		
• TNUXE08060	8 x 60 Ø8	57,697	SW10/TX30	10	50	600
• TNUXE08080	8 x 80 Ø8	65,753	SW10/TX30	10	50	600
• TNUXE08100	8 x 100 Ø8	83,063	SW10/TX30	30	50	300
• TNUXE08120	8 x 120 Ø8	97,270	SW10/TX30	50	50	300
• TNUXE10060	10 x 60 Ø10	84,987	SW13/TX40	10	50	300
TNUXE10080	10 x 80 Ø10	100,213	SW13/TX40	10	50	300
TNUXE10100	10 x 100 Ø10	122,320	SW13/TX40	30	50	300
TNUXE10120	10 x 120 Ø10	155,040	SW13/TX40	50	50	300
TNUXE10140	10 x 140 Ø10	197,860	SW13/TX40	70	50	200
TNUXE10160	10 x 160 Ø10	198,327	SW13/TX40	90	50	150
TNUXE10180	10 x 180 Ø10	239,097	SW13/TX40	110	50	150
TNUXE10200	10 x 200 Ø10	316,100	SW13/TX40	130	50	150
TNUXE10230	10 x 230 Ø10	385,193	SW13/TX40	160	50	100

• Medidas sin homologar
• Medida sin homologar para fuego

02 Info
Técnica
p. 400

Caja ventana

Bolsa autoservicio

CÓDIGO	MEDIDA	€/BOLSA	PCS	BOLSAS
BZTNXE08080	8 x 80 Ø8	3,216	2	15
BZTNXE08100	8 x 100 Ø8	3,216	2	15
BZTNXE08120	8 x 120 Ø8	3,216	2	15
BZTNXE10080	10 x 80 Ø10	3,216	2	15
BZTNXE10100	10 x 100 Ø10	3,216	2	15
BZTNXE10120	10 x 120 Ø10	3,216	2	15

CÓDIGO	MEDIDA	€/CAJA	PCS	CAJAS
VTNUXE08080	8 x 80 Ø8	6,531	8	8
VTNUXE08100	8 x 100 Ø8	8,246	8	8
VTNUXE10080	10 x 80 Ø10	9,951	8	8
VTNUXE10100	10 x 100 Ø10	11,534	8	8

CÓDIGO	MEDIDA	€/BOLSA	PCS	BOLSAS
LSTNXE08080	8 x 80 Ø8	7,271	10	8
LSTNXE08100	8 x 100 Ø8	9,187	10	8
LSTNXE08120	8 x 120 Ø8	9,644	8	8
LSTNXE10080	10 x 80 Ø10	6,652	6	6
LSTNXE10100	10 x 100 Ø10	7,717	6	6

T-NUX

Taco de nylon universal de alto rendimiento

T-NUX E A4

Inoxidable A4. Cabeza hexagonal. Huella TX. Homologado ETE



INOXIDABLE



CÓDIGO	MEDIDA	€/100	Nº HUELLA	ESPELOR MÁX. A FIJAR		
• TNXE408080	8 x 80 Ø8	377,869	SW10/TX30	10	50	600
• TNXE408100	8 x 100 Ø8	447,874	SW10/TX30	30	50	300
TNXE410080	10 x 80 Ø10	501,207	SW13/TX40	10	50	300
TNXE410100	10 x 100 Ø10	523,441	SW13/TX40	30	50	300
TNXE410120	10 x 120 Ø10	629,179	SW13/TX40	50	50	300
TNXE410140	10 x 140 Ø10	733,938	SW13/TX40	70	50	200

• Medida sin homologar para fuego

T-NUX T

Cabeza Truss inviolable. Huella TX. Cincado. Homologado ETE



Disponible en varios recubrimientos. Consulte precio y plazo de entrega.



MULTIMATERIAL



CÓDIGO	MEDIDA	€/100		ESPELOR MÁX. A FIJAR		
TNuxt10080	10 x 80 Ø10	103,293	TX40	10	50	300
TNuxt10100	10 x 100 Ø10	116,713	TX40	30	50	300
TNuxt10120	10 x 120 Ø10	137,073	TX40	50	50	200
TNuxt10140	10 x 140 Ø10	170,303	TX40	70	50	200
TNuxt10160	10 x 160 Ø10	181,770	TX40	90	50	200

T-FUX E

Taco cabeza cilíndrica. Tornillo cabeza hexagonal. Huella TX. Cincado. Homologado ETE



MULTIMATERIAL



CÓDIGO	MEDIDA	€/100		ESPELOR MÁX. A FIJAR		
• TFUXE10080	10 x 80 Ø10	111,887	SW13/TX40	10	50	300
TFUXE10100	10 x 100 Ø10	129,747	SW13/TX40	30	50	200
TFUXE10120	10 x 120 Ø10	169,380	SW13/TX40	50	50	200

• Medida sin homologar para fuego

T-NUX

Taco de nylon



MULTIMATERIAL



CÓDIGO	MEDIDA	€/100	ESPELOR MÁX. A FIJAR		
TNux08060	8 x 60	24,293	-	50	800
TNux08080	8 x 80	26,200	-	50	600
TNux08100	8 x 100	30,200	-	50	600
TNux08120	8 x 120	33,307	-	50	600
TNux10060	10 x 60	31,317	-	50	600
TNux10080	10 x 80	31,753	-	50	600
TNux10100	10 x 100	38,643	-	50	600
TNux10120	10 x 120	45,520	-	50	600
TNux10140	10 x 140	59,287	-	50	300



Taco clavable poliamida 6.6

TCA



MULTIMATERIAL



CÓDIGO	MEDIDA	€/100		ESPEJOR MÁX. A FIJAR		
TC6A08080	8 x 80 Ø8	55,463	TX30	15	100	600
TC6A08100	8 x 100 Ø8	64,473	TX30	35	100	400
TC6A08120	8 x 120 Ø8	76,200	TX30	55	100	400
TC6A10100	10 x 100 Ø10	91,510	TX40	25	100	300
TC6A10120	10 x 120 Ø10	97,160	TX40	40	100	300
TC6A10140	10 x 140 Ø10	112,193	TX40	60	100	300
TC6A10160	10 x 160 Ø10	131,653	TX40	85	100	200
TC6A10200	10 x 200 Ø10	218,673	TX40	125	100	-

TC-6A

Taco de 6 alas con tornillo avellanado



MULTIMATERIAL



CÓDIGO	MEDIDA	€/100		ESPEJOR MÁX. A FIJAR		
TC6E08080	8 x 80 Ø8	63,500	SW10/TX30	15	100	600
TC6E08100	8 x 100 Ø8	74,033	SW10/TX30	35	100	400
TC6E08120	8 x 120 Ø8	88,003	SW10/TX30	55	100	300
TC6E10100	10 x 100 Ø10	106,950	SW13/TX40	25	100	300
TC6E10120	10 x 120 Ø10	110,893	SW13/TX40	40	100	300
TC6E10140	10 x 140 Ø10	130,887	SW13/TX40	60	100	200
TC6E10160	10 x 160 Ø10	154,647	SW13/TX40	85	100	200
TC6E10200	10 x 200 Ø10	261,003	SW13/TX40	125	100	-

TC-6E

Taco de 6 alas con tornillo hexagonal



MULTIMATERIAL



CÓDIGO	MEDIDA	€/100		ESPEJOR MÁX. A FIJAR		
TC2A06060	6 X 60 Ø6	30,933	PZ 2	30	100	1.200
TC2A08060	8 X 60 Ø8	40,840	PZ 3	20	100	600
TC2A08080	8 x 80 Ø8	55,463	PZ 3	40	100	600
TC2A08100	8 x 100 Ø8	64,473	PZ 3	60	100	400
TC2A08120	8 x 120 Ø8	76,200	PZ 3	80	100	400
TC2A10065	10 x 65 Ø10	78,383	PZ 4	20	100	400
TC2A10080	10 x 80 Ø10	83,373	PZ 4	35	100	400
TC2A10100	10 x 100 Ø10	91,510	PZ 4	55	100	300
TC2A10115	10 x 115 Ø10	97,160	PZ 4	70	100	300
TC2A10135	10 x 135 Ø10	112,193	PZ 4	90	100	300
TC2A10160	10 x 160 Ø10	131,653	PZ 4	115	100	200

TC-2A

Taco de 2 alas con tornillo avellanado



TC-SP

Taco clavable de alta expansión

TC-SP

Taco con cabeza avellanada



02 Info. Técnica P. 401

MULTIMATERIAL



CÓDIGO	MEDIDA	€/100	Nº HUELLA	ESPESOR MÁX. A FIJAR		
TCSP05027	5 x 27	9,429	PZ2	5	100	2.400
TCSP06032	6 x 32	11,095	PZ2	5	100	1.200
TCSP06040	6 x 40	11,498	PZ2	10	100	1.200

TC-SP EP

Bote de plástico



MULTIMATERIAL



CÓDIGO	MEDIDA	€/PC	Nº HUELLA	ESPESOR MÁX. A FIJAR		PCS. X BOTE
TCSPEP05027	5 x 27	68,511	PZ2	5	1	750
TCSPEP06032	6 x 32	53,808	PZ2	5	1	500
TCSPEP06040	6 x 40	55,567	PZ2	10	1	500

TC

Taco clavable de poliamida 6.6, premontado con tornillo rosca-arpón

TC-A2

Taco con cabeza avellanada y tornillo inoxidable A2



02 Info. Técnica P. 402

INOXIDABLE



CÓDIGO	MEDIDA	€/100		ESPESOR MÁX. A FIJAR		
TCA205030	5 x 30 Ø5	43,177	PZ2	5	100	2.400
TCA206040	6 x 40 Ø6	56,177	PZ2	10	100	1.200
TCA206060	6 x 60 Ø6	80,370	PZ2	30	100	1.200
TCA208060	8 x 60 Ø8	126,493	PZ3	20	100	600
TCA208080	8 x 80 Ø8	148,397	PZ3	40	100	600
TCA208100	8 x 100 Ø8	195,183	PZ3	60	100	600

TC-CC

Taco con cabeza cilíndrica



02 Info. Técnica P. 402

MULTIMATERIAL



CÓDIGO	MEDIDA	€/100		ESPESOR MÁX. A FIJAR	UD. MIN. VENTA		
TCCC05025	5 x 25 Ø5	7,461	PZ2	5	400	100	2.400
TCCC05030	5 x 30 Ø5	7,801	PZ2	5	400	100	2.400
TCCC05035	5 x 35 Ø5	8,820	PZ2	10	400	100	2.400
TCCC05050	5 x 50 Ø5	9,967	PZ2	25	200	100	1.200
TCCC06035	6 x 35 Ø6	9,617	PZ2	10	400	100	1.200
TCCC06040	6 x 40 Ø6	9,705	PZ2	15	400	100	1.200
TCCC06050	6 x 50 Ø6	11,780	PZ2	25	200	100	1.200
TCCC06060	6 x 60 Ø6	13,792	PZ2	35	200	100	1.200
TCCC06070	6 x 70 Ø6	17,036	PZ2	45	200	100	1.200
TCCC06080	6 x 80 Ø6	18,933	PZ2	55	-	100	1.200
TCCC08060	8 x 60 Ø8	21,203	PZ3	20	200	100	600
TCCC08080	8 x 80 Ø8	26,850	PZ3	40	200	100	600
TCCC08100	8 x 100 Ø8	32,830	PZ3	60	100	100	600
TCCC08120	8 x 120 Ø8	39,720	PZ3	80	100	100	400
TCCC08140	8 x 140 Ø8	49,863	PZ3	100	100	100	300

Bolsa autoservicio

CÓDIGO	MEDIDA	€/BOLSA	PCS	BOLSAS
LSTCCC05025	5 x 25 Ø5	3,410	30	10
LSTCCC05030	5 x 30 Ø5	3,597	30	8
LSTCCC05035	5 x 35 Ø5	3,829	30	7
LSTCCC05050	5 x 50 Ø5	4,305	30	7
LSTCCC06035	6 x 35 Ø6	4,273	30	7
LSTCCC06040	6 x 40 Ø6	4,322	30	6
LSTCCC06050	6 x 50 Ø6	4,449	25	6
LSTCCC06060	6 x 60 Ø6	5,122	25	6
LSTCCC06070	6 x 70 Ø6	5,596	25	6
LSTCCC08060	8 x 60 Ø8	5,554	20	6

Bolsa autoservicio

CÓDIGO	MEDIDA	€/BOLSA	PCS	BOLSAS
LSTCCC08080	8 x 80 Ø8	6,955	20	6



Taco clavable de poliamida 6.6, premontado con tornillo rosca-arpón

TC



MULTIMATERIAL



TC-CA

Taco con cabeza avellanada

CÓDIGO	MEDIDA	€/100	ES	ESPESOR MÁX. A FIJAR	UD. MIN. VENTA	100	100
TCCA05025	5 x 25 Ø5	7,461	PZ2	5	400	100	2.400
TCCA05030	5 x 30 Ø5	7,801	PZ2	5	400	100	2.400
TCCA05035	5 x 35 Ø5	8,820	PZ2	10	400	100	2.400
TCCA05050	5 x 50 Ø5	9,967	PZ2	25	200	100	1.200
TCCA06035	6 x 35 Ø6	9,617	PZ2	10	400	100	1.200
TCCA06040	6 x 40 Ø6	9,705	PZ2	10	400	100	1.200
TCCA06050	6 x 50 Ø6	11,780	PZ2	20	200	100	1.200
TCCA06060	6 x 60 Ø6	13,792	PZ2	30	200	100	1.200
TCCA06070	6 x 70 Ø6	17,036	PZ2	40	200	100	1.200
TCCA06080	6 x 80 Ø6	18,933	PZ2	50	200	100	1.200
TCCA08060	8 x 60 Ø8	21,203	PZ3	20	200	100	600
TCCA08080	8 x 80 Ø8	26,850	PZ3	40	200	100	600
TCCA08100	8 x 100 Ø8	32,830	PZ3	60	100	100	600
TCCA08120	8 x 120 Ø8	39,720	PZ3	80	100	100	400
TCCA08140	8 x 140 Ø8	49,863	PZ3	100	100	100	300



TAMBIÉN DISPONIBLE EN
easykits



Blíster

CÓDIGO	MEDIDA	€/BOLSA	PCS	BOLSAS
BZTCCA05030	5 x 30 Ø5	2,459	4	20
BZTCCA05050	5 x 50 Ø5	2,459	4	20
BZTCCA06040	6 x 40 Ø6	2,459	4	20
BZTCCA06050	6 x 50 Ø6	2,459	4	20
BZTCCA06060	6 x 60 Ø6	2,459	4	20
BZTCCA06070	6 x 70 Ø6	2,459	4	20
BZTCCA08060	8 x 60 Ø8	2,459	4	20
BZTCCA08080	8 x 80 Ø8	2,459	4	20
BZTCCA08100	8 x 100 Ø8	2,459	2	20
BZTCCA08120	8 x 120 Ø8	2,459	2	20

Caja ventana

CÓDIGO	MEDIDA	€/CAJA	PCS	CAJAS
VTCCA05025	5 x 25 Ø5	3,260	30	8
VTCCA05030	5 x 30 Ø5	3,355	30	8
VTCCA05035	5 x 35 Ø5	3,773	30	8
VTCCA05050	5 x 50 Ø5	4,084	30	8
VTCCA06035	6 x 35 Ø6	3,937	30	8
VTCCA06040	6 x 40 Ø6	4,041	30	8
VTCCA06050	6 x 50 Ø6	4,436	30	8
VTCCA06060	6 x 60 Ø6	4,577	25	8
VTCCA06070	6 x 70 Ø6	5,652	25	8
VTCCA08060	8 x 60 Ø8	5,498	20	8
VTCCA08080	8 x 80 Ø8	7,020	20	8

Bolsa autoservicio

CÓDIGO	MEDIDA	€/BOLSA	PCS	BOLSAS
LSTCCA05025	5 x 25 Ø5	3,410	30	10
LSTCCA05030	5 x 30 Ø5	3,597	30	8
LSTCCA05035	5 x 35 Ø5	3,829	30	7
LSTCCA05050	5 x 50 Ø5	4,305	30	7
LSTCCA06035	6 x 35 Ø6	4,273	30	7
LSTCCA06040	6 x 40 Ø6	4,322	30	6
LSTCCA06050	6 x 50 Ø6	4,449	25	6
LSTCCA06060	6 x 60 Ø6	5,122	25	6
LSTCCA06070	6 x 70 Ø6	5,596	25	6
LSTCCA08060	8 x 60 Ø8	5,554	20	6
LSTCCA08080	8 x 80 Ø8	6,955	20	6

MULTIMATERIAL



TC-CA EP

Bote de plástico

CÓDIGO	MEDIDA	€/PC	ES	ESPESOR MÁX. A FIJAR	UD. MIN. VENTA	1	PCS. X BOTE
TCCAEP5030	5 x 30 Ø5	54,612	PZ3	5	2	1	750
TCCAEP6040	6 x 40 Ø6	45,714	PZ3	10	2	1	500



TN4S

Los tacos de nylon anudables TN4S de INDEX, ofrecen unas máximas prestaciones gracias a su expansión en 4 direcciones. Destacan por su versatilidad en la instalación, siendo aptos para su aplicación tanto en materiales macizos (hormigón, ladrillo macizo), como en materiales huecos (ladrillo hueco, bloques de hormigón hueco, placa yeso). Pueden llegar a soportar cargas de más de 600 kg por punto de apoyo. Están fabricados con Nylon® de alta calidad (poliamida 6).



CUALIDADES Y VENTAJAS



MÁXIMAS PRESTACIONES

Expande en 4 direcciones, lo que garantiza una perfecta adherencia sobre el material base. En los materiales huecos, al introducir el tornillo/tirafondo, el taco se anuda retrayéndose y presionando sobre el material base y permitiendo un correcto agarre.



MULTIMATERIAL

Recomendado tanto para materiales base macizos (hormigón, piedra, ladrillo macizo, ladrillo de adobe, hormigón celular), como huecos (ladrillo hueco, bloque hueco, placa de yeso laminado, placas alveolares).



VERSATILIDAD

Recomendable para utilizar con una amplia gama de tornillos (tornillos con rosca aglomerado, tornillos avellanados, tornillos barraqueros...), así como otro tipo de productos (alcayatas o hembrillas).



FACILIDAD DE USO

El collarín evita que el taco se cuele en el interior del material base durante la instalación. El taco dispone de varios anti-giros laterales que ayudan a que el taco no gire al introducir el tornillo/tirafondo.

APLICACIONES



- Verjas
- Barandillas
- Soportes
- Estanterías
- Rótulos
- Sanitarios y/o instalaciones de baños
- Cuadros
- Elementos ligeros
- Iluminación
- Rodapiés
- Buzones
- Muebles de TV
- Canaletas eléctricas
- Muebles

TN4S

Taco de nylon anudable de 4 segmentos para todo tipo de materiales

TN4S

Taco



MULTIMATERIAL



CÓDIGO	MEDIDA	€/100	MEDIDA TORNILLO	UD. MIN. VENTA	
TN4S05	5 x 25 Ø5	3,587	TPPO 3-4	400	100
TN4S06	6 x 30 Ø6	3,752	TPPO 4-5	400	100
TN4S08	8 x 40 Ø8	5,940	TPPO 4,5, TB 5-6	400	100
TN4S10	10 x 50 Ø10	10,667	TB 6-8	200	50
TN4S12	12 x 60 Ø12	20,929	TB 8-10	50	25
TN4S14	14 x 70 Ø14	28,040	TB 10-12	40	20



CÓDIGO	MEDIDA	€/BOLSA	PCS BOLSAS	BOLSAS
BZTN4S05	5 x 25 Ø5	2,459	25	15
BZTN4S06	6 x 30 Ø6	2,459	25	15
BZTN4S08	8 x 40 Ø8	2,459	15	10
BZTN4S10	10 x 50 Ø10	2,459	10	10



CÓDIGO	MEDIDA	€/BOLSA	PCS BOLSAS	BOLSAS
BZTN4S12	12 x 60 Ø12	2,459	6	10

TN4S EP

Bote de plástico



MULTIMATERIAL



CÓDIGO	MEDIDA	€/PC	MEDIDA TORNILLO	UD. MIN. VENTA			PCS. X BOTE
TN4S06EP	6 x 30 Ø6	34,227	TPPO 4-5	2	1	3	1.000
TN4S08EP	8 x 40 Ø8	27,590	TPPO 4,5, TB 5-6	2	1	3	500
TN4S10EP	10 x 50 Ø10	29,434	TB 6-8	2	1	3	300



Taco de nylon anudable de 4 segmentos para todo tipo de materiales

TN4S



MULTIMATERIAL



Blíster

CÓDIGO	MEDIDA	€/BOLSA	PCS	BOLSAS
BZALHATS05	5 x 25 Ø5 + 19x70 / 4,4x50	2,459	6	20
BZALHATS06	6x30 Ø6 + 20x80 / 5x53	2,459	6	15
BZALHATS08	8x40 Ø8 + 21x100 / 5,6x60	2,459	4	20

TN4S + AL-HA

Taco + hembra abierta



MULTIMATERIAL



Blíster

CÓDIGO	MEDIDA	€/BOLSA	PCS	BOLSAS
BZALHCTS05	5x25 Ø5 + 19x70 / 4,4x50	2,459	6	20
BZALHCTS06	6x30 Ø6 + 20x80 / 5x53	2,459	6	15
BZALHCTS08	8x40 Ø8 + 21x100 / 5,6x60	2,459	4	20

TN4S + AL-HC

Taco + hembra cerrada



MULTIMATERIAL



Blíster

CÓDIGO	MEDIDA	€/BOLSA	PCS	BOLSAS
BZALROTS05	5x25 Ø5 + 18x50 / 4,1x37	2,459	6	20
BZALROTS06	6x30 Ø6 + 19x60 / 4,4x46	2,459	6	20
BZALROTS08	8x40 Ø8 + 20x80 / 5x63	2,459	4	20

TN4S + AL-RO

Taco + alcazata roscada



MULTIMATERIAL



Caja ventana

CÓDIGO	MEDIDA	€/CAJA	PCS	CAJAS
VTBTS08	8 x 40 Ø8 & 6 x 60	6,463	25	8
VTBTS10	10 x 50 Ø10 & 7 x 70	6,700	15	8
VTBTS12	12 x 60 Ø12 & 7 x 70	6,444	10	8

Blíster

CÓDIGO	MEDIDA	€/BOLSA	PCS	BOLSAS
BZTBTS10	10x50 Ø10 + 7x70	2,459	4	20

TN4S + DIN-571

Taco + tornillo barraquero



MULTIMATERIAL



Caja ventana

CÓDIGO	MEDIDA	€/CAJA	PCS	CAJAS
VTBTPOTS05	5 x 25 Ø5 & 4 x 30	4,581	40	8
VTBTPOTS06	6 x 30 Ø6 & 4,5 x 40	4,779	32	8
VTBTPOTS08	8 x 40 Ø8 & 5 x 60	5,050	20	8

Blíster

CÓDIGO	MEDIDA	€/BOLSA	PCS	BOLSAS
BZTTPOTS05	5x25 Ø5 + 4x30	2,459	6	20
BZTTPOTS06	6x30 Ø6 + 4,5x40	2,459	6	20
BZTTPOTS08	8x40 Ø8 + 5x60	2,459	6	15

TN4S + TP-PO

Taco + tirafondo



TN4S

Taco de nylon anudable de 4 segmentos para todo tipo de materiales

NEW TN4S + TP-PO EP

Taco + Tirafondo. Bote de plástico



MULTIMATERIAL



CÓDIGO	MEDIDA	€/PC	MEDIDA TORNILLO	UD. MIN. VENTA			PCS. X BOTE
TPPOTS06EP	6x30 Ø6+4,5x40	24,259	-	-	1	6	250
TPPOTS08EP	8x40 Ø8+5x50	21,660	-	-	1	6	150

TN4S-L

Taco largo



02 Info Técnica P. 404

MULTIMATERIAL



CÓDIGO	MEDIDA	€/100	MEDIDA TORNILLO		
TN4S06L	6 x 45 Ø6	6,982	TPPO 4-5	100	1.600
TN4S08L	8 x 60 Ø8	12,737	TPPO 4,5, TB 5-6	50	800
TN4S10L	10 x 80 Ø10	24,023	TB 6-8	25	400

NEW TN4S-A

Taco con collarín



MULTIMATERIAL



CÓDIGO	MEDIDA	€/100	MEDIDA TORNILLO	UD. MIN. VENTA	
TN4SA06	6	4,426	TPPO 3,5-4	-	100

NEW TN4S-A EP

Taco con collarín. Bote de plástico



MULTIMATERIAL



CÓDIGO	MEDIDA	€/PC	MEDIDA TORNILLO	UD. MIN. VENTA			PCS. X BOTE
TN4SA06EP	6	39,879	TPPO 4-5	-	1	-	1.000

MEDU

Taco universal con collarín y forma de nudo



02 Info Técnica P. 404

HUECOS



CÓDIGO	MEDIDA	VÁLIDO PARA	€/100	UD. MIN. VENTA		
MEDUB06	6 x 35 Ø6	TPPO 3,5-4	3,500	600	150	2.400
MEDUB07	8 x 45 Ø8	TPPO 4	7,843	400	100	1.600
MEDUB08	8 x 50 Ø8	TPPO 4-4,5	6,013	320	80	1.200
MEDUB10	10 x 60 Ø10	TPPO 6, TB 6-7	9,003	200	50	800

Blíster

CÓDIGO	MEDIDA	€/BOLSA	PCS BLS	BOLSAS
BZMEDUB06	6 x 35 Ø6	2,459	10	20
BZMEDUB08	8 x 50 Ø8	2,459	10	20
BZMEDUB10	10 x 60 Ø10	2,459	6	20



Taco de nylon

TACON

MULTIMATERIAL



Blíster

CÓDIGO	MEDIDA	€/BOLSA	PCS	BOLSAS
BZALHAT04	4x20 Ø4 + 16x30 / 3,1x25	1,943	6	20
BZALHAT05	5x25 Ø5 + 19x70 / 4,4x50	1,943	6	20
BZALHAT06	6x30 Ø6 + 20x80 / 5x55	1,943	6	15
BZALHAT08	8x40 Ø8 + 21x100 / 5,6x60	1,943	4	15

TACON + AL-HA

Taco + hembra abierta



MULTIMATERIAL



Blíster

CÓDIGO	MEDIDA	€/BOLSA	PCS	BOLSAS
BZALHCT04	4x20 Ø4 + 16x30 / 3,1x25	1,943	6	20
BZALHCT05	5x25 Ø5 + 19x70 / 4,4x50	1,943	6	20
BZALHCT06	6x30 Ø6 + 20x80 / 5x55	1,943	6	15
BZALHCT08	8x40 Ø8 + 21x100 / 5,6x60	1,943	4	15

TACON + AL-HC

Taco + hembra cerrada



KITS
DISPONIBLES
BLISTER



MULTIMATERIAL



Blíster

CÓDIGO	MEDIDA	€/BOLSA	PCS	BOLSAS
BZALROT04	4x20 Ø4 + 16x30 / 3,1x20	1,943	6	20
BZALROT05	5x25 Ø5 + 17x40 / 3,5x29	1,943	6	20
BZALROT06	6x30 Ø6 + 19x60 / 4,4x46	1,943	6	20
BZALROT08	8x40 Ø8 + 20x80 / 5x63	1,943	4	15

TACON + AL-RO

Taco + alcazata roscada



MULTIMATERIAL



Blíster

CÓDIGO	MEDIDA	€/BOLSA	PCS	BOLSAS
BZTPPOT04	4x20 Ø4 + 2,5x25	1,943	6	20
BZTPPOT05	6x30 Ø5 + 3,5x20	1,943	6	20
BZTPPOT06	6x30 Ø6 + 4,5x40	1,943	6	20
BZTPPOT08	8x40 Ø8 + 6x50	1,943	4	15

TACON + TP-PO

Taco + tirafondo



TACON

Taco de nylon

TACON

Taco



MULTIMATERIAL



CÓDIGO	MEDIDA	€/100	MEDIDA TORNILLO	UD. MIN. VENTA	
TACON04	4 x 20 Ø4	3,173	TPPO 2,5-3	400	100
TACON05	5 x 25 Ø5	2,293	TPPO 2,5-4	400	100
TACON06	6 x 30 Ø6	2,353	TPPO 3,5-4	400	100
TACON07	7 x 30 Ø7	4,910	TPPO 4-4,5	400	100
TACON08	8 x 40 Ø8	4,633	TPPO 4,5, TB 5-6	400	100
TACON10	10 x 50 Ø10	7,810	TB 6-8	200	50
TACON12	12 x 60 Ø12	14,310	TB 8-10	100	25
TACON14	14 x 70 Ø14	23,137	TB 10-12	80	20
TACON16	16 x 80 Ø16	131,147	TB 12-14	40	10



CÓDIGO	MEDIDA	€/BOLSA	PCS	BOLSAS
BZTACON04	4 x 20 Ø4	1,943	25	15
BZTACON05	5 x 25 Ø5	1,943	25	15
BZTACON06	6 x 30 Ø6	1,943	25	15
BZTACON08	8 x 40 Ø8	1,943	15	10
BZTACON10	10 x 50 Ø10	1,943	10	10



CÓDIGO	MEDIDA	€/BOLSA	PCS	BOLSAS
BZTACON12	12 x 60 Ø12	1,943	5	10

TACOL

Taco con collarín



MULTIMATERIAL



CÓDIGO	MEDIDA	€/100	MEDIDA TORNILLO	UD. MIN. VENTA	
TACOL05	5 x 25 Ø5	2,883	TPPO 2,5-4	400	100
TACOL06	6 x 30 Ø6	2,460	TPPO 3,5-4	400	100
TACOL08	8 x 40 Ø8	4,980	TPPO 4,5, TB 5-6	400	100
TACOL10	10 x 50 Ø10	9,387	TB 6-8	200	50
TACOL12	12 x 60 Ø12	18,883	TB 8-10	100	25

TACOL-A

Taco de nylon con collarín ancho



MULTIMATERIAL



CÓDIGO	MEDIDA	€/100	MEDIDA TORNILLO		
TACOLA06	6 x 30 Ø6	2,860	TPPO 3,5-4	100	2.400

Taco de nylon para ladrillos huecos y materiales macizos

MULTIMATERIAL



CÓDIGO	MEDIDA	€/100	UD. MIN. VENTA	UD. MIN. VENTA
IPACA08	M4 x 30 Ø8	23,177	100	1.200

IPA-CA NEW

Taco de nylon



MULTIMATERIAL



CÓDIGO	MEDIDA	€/100	Ø ARANDELA	UD. MIN. VENTA	UD. MIN. VENTA	UD. MIN. VENTA
IPAGR09	M4 x 40 Ø9	37,133	20	100	50	800
IPAGR12	M5 x 45 Ø12	52,377	25	50	25	400

IPA-GR

Gancho recto



MULTIMATERIAL



CÓDIGO	MEDIDA	€/100	Ø ARANDELA	UD. MIN. VENTA	UD. MIN. VENTA	UD. MIN. VENTA
IPAGN09	M4 x 40 Ø9	43,410	20	80	40	640
IPAGN12	M5 x 45 Ø12	59,477	25	40	20	320

IPA-GN

Gancho normal



MULTIMATERIAL



CÓDIGO	MEDIDA	€/100	Ø ARANDELA	UD. MIN. VENTA	UD. MIN. VENTA	UD. MIN. VENTA
IPAA09	M4 x 40 Ø9	43,320	20	80	40	640
IPAA12	M5 x 45 Ø12	59,243	25	40	20	320

IPA-AR

Argolla



MULTIMATERIAL



CÓDIGO	MEDIDA	€/100	Ø ARANDELA	UD. MIN. VENTA	UD. MIN. VENTA	UD. MIN. VENTA
IPAT09	M4 x 40 Ø9	34,013	20	140	70	1.120
IPAT12	M5 x 45 Ø12	51,743	25	70	35	560

IPA-TO

Tornillo



Taco de plástico (polipropileno)



MULTIMATERIAL



CÓDIGO	MEDIDA	€/100	UD. MIN. VENTA	UD. MIN. VENTA	UD. MIN. VENTA
TACOP05	5 x 21 Ø5	1,943	1.000	25	1.000
TACOP06	6 x 22 Ø6	2,183	1.000	25	1.000
TACOP07	7 x 23 Ø7	2,407	1.000	25	1.000
TACOP08	8 x 27 Ø8	2,607	1.000	25	1.000
TACOP09	9 x 30 Ø9	3,670	1.000	25	1.000
TACOP10	10 x 35 Ø10	4,697	1.000	25	1.000
TACOP11	10 x 43 Ø10	7,960	500	25	500
TACOP12	12 x 45 Ø12	7,247	500	25	500
TACOP14	14 x 48 Ø14	9,863	500	25	500





FIJACIONES Y ACCESORIOS PARA SISTEMAS DE AISLAMIENTO TÉRMICO (SATE)



INDEX
A PERFECT FIXING

AIS-C

Taco de fijación de paneles aislantes. Taco con clavo de poliamida. Homologado ETE

02 Info. Técnica
P. 402

MULTIMATERIAL



CÓDIGO	MEDIDA	€/100	ESPESOR MÁX. A FIJAR	UD. MIN. VENTA	
AISC10070	Ø10 x 70	22,756	20	200	200
AISC10090	Ø10 x 90	24,564	40	200	200
AISC10100	Ø10 x 100	26,817	50	-	200
AISC10120	Ø10 x 120	28,915	70	-	200
AISC10140	Ø10 x 140	32,462	90	-	200
AISC10160	Ø10 x 160	35,112	110	-	200
AISC10180	Ø10 x 180	37,528	130	-	200
AISC10200	Ø10 x 200	49,590	150	-	200
AISC10220	Ø10 x 220	53,501	170	-	200
AISC10260	Ø10 x 260	60,103	210	-	100

AIS-S

Taco de fijación de paneles aislantes. Taco con clavo metálico y tapón de poliamida. Homologado ETE

02 Info. Técnica
P. 403

MULTIMATERIAL

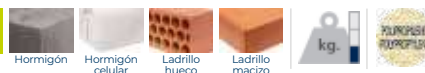

CÓDIGO	MEDIDA	€/100	ESPESOR MÁX. A FIJAR	
AISS10070	Ø10 x 70	52,697	20	200
AISS10090	Ø10 x 90	56,493	40	200
AISS10100	Ø10 x 100	64,360	50	200
AISS10120	Ø10 x 120	69,398	70	200
AISS10140	Ø10 x 140	77,910	90	200
AISS10160	Ø10 x 160	84,271	110	200
AISS10180	Ø10 x 180	95,640	130	200
AISS10200	Ø10 x 200	104,402	150	200
AISS10220	Ø10 x 220	118,560	170	200
AISS10260	Ø10 x 260	126,531	210	200

AIS

Taco de fijación de paneles aislantes

02 Info. Técnica
P. 403

MULTIMATERIAL



CÓDIGO	MEDIDA	€/100	ESPESOR MÁX. A FIJAR		
AIS08080	Ø8 x 80	20,767	50	100	200
AIS08100	Ø8 x 100	24,370	70	100	-
AIS08120	Ø8 x 110	27,043	80	100	-
AIS08140	Ø8 x 130	27,137	100	100	-

AIS-R

Taco de fijación de paneles aislantes. Rosetón

02 Info. Técnica
P. 403

MULTIMATERIAL



CÓDIGO	MEDIDA	€/100	
AISR140	Ø140	41,800	200

Taco de fijación de paneles aislantes. Rosetón para uso con tornillo

AIS-W

02 Info. Técnica
P. 403

MULTIMATERIAL



CÓDIGO	MEDIDA	€/100	
AISW060	Ø60	20,140	500



Taco metálico de fijación de paneles aislantes

AIS-M

02 Info. Técnica
P. 403

MULTIMATERIAL



CÓDIGO	MEDIDA	€/100	ESPESOR MÁX. A FIJAR	
AISM08090	Ø8 x 90	31,920	50	250
AISM08110	Ø8 x 110	37,525	70	250
AISM08120	Ø8 x 120	38,760	80	250
AISM08140	Ø8 x 140	43,510	100	250
AISM08170	Ø8 x 170	52,155	130	250
AISM08200	Ø8 x 200	67,355	160	250
AISM08250	Ø8 x 250	79,040	210	250
AISM08300	Ø8 x 300	129,580	260	250



Arandela de taco metálico para fijación de paneles aislantes

AIS-AM

02 Info. Técnica
P. 403

MULTIMATERIAL



CÓDIGO	MEDIDA	€/100	
AISAM085	Ø85	97,565	250



Anclaje espiral para fijación sobre paneles aislantes

TE

02 Info. Técnica
P. 403

MULTIMATERIAL



CÓDIGO	MEDIDA	€/100		
TE25050	25 x 50	76,665	50	600
TE25090	25 x 90	130,340	25	300





FIJACIONES PARA MATERIALES HUECOS



BA-NO

Basculantes por gravedad para la fijación de elementos ligeros en falsos techos

BA-ES

Espiga



02 Info. Técnica P. 406

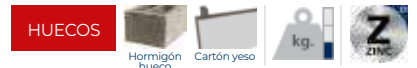

CÓDIGO	MEDIDA	€/100	UD. MIN. VENTA		
BAESM04	M4 Ø14	65,523	100	50	300
BAESM05	M5 Ø14	71,216	100	50	300
BAESM06	M6 Ø16	90,813	100	50	200
BAESM08	M8 Ø20	149,363	50	50	200

Blíster

CÓDIGO	MEDIDA	€/BOLSA	PCS	BOLSAS
BZBAESM04	M4 Ø14	3,216	2	12
BZBAESM05	M5 Ø14	3,216	2	12
BZBAESM06	M6 Ø16	3,216	2	10

Caja ventana

CÓDIGO	MEDIDA	€/CAJA	PCS	CAJAS
VBAESM04	M4 Ø14	5,837	6	8
VBAESM05	M5 Ø14	6,180	6	8
VBAESM06	M6 Ø16	5,217	4	8

Bolsa autoservicio

CÓDIGO	MEDIDA	€/BOLSA	PCS	BOLSAS
LSBAESM04	M4 Ø14	5,612	6	6
LSBAESM05	M5 Ø14	5,779	6	6
LSBAESM06	M6 Ø16	5,014	4	6

TAMBIÉN DISPONIBLE EN
easykits

BA-GA

Gancho



02 Info. Técnica P. 406

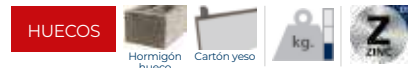

CÓDIGO	MEDIDA	€/100	UD. MIN. VENTA		
BAGAM04	M4 Ø14	69,510	100	50	300
BAGAM05	M5 Ø14	74,187	100	50	300
BAGAM06	M6 Ø16	92,710	100	50	200
BAGAM08	M8 Ø20	155,073	50	50	150

Blíster

CÓDIGO	MEDIDA	€/BOLSA	PCS	BOLSAS
BZBAGAM04	M4 Ø14	3,216	2	12
BZBAGAM05	M5 Ø14	3,216	2	12
BZBAGAM06	M6 Ø16	3,216	2	10

Caja ventana

CÓDIGO	MEDIDA	€/CAJA	PCS	CAJAS
VBAGAM04	M4 Ø14	6,047	6	8
VBAGAM05	M5 Ø14	6,330	6	8
VBAGAM06	M6 Ø16	5,453	4	8

Bolsa autoservicio

CÓDIGO	MEDIDA	€/BOLSA	PCS	BOLSAS
LSBAGAM04	M4 Ø14	5,651	6	6
LSBAGAM05	M5 Ø14	6,086	6	6
LSBAGAM06	M6 Ø16	5,096	4	6

TAMBIÉN DISPONIBLE EN
easykits

CA-BA

Cabeza de basculante



CÓDIGO	MEDIDA	€/100		
CABA004	M4 Ø14	33,780	100	1.200
CABA005	M5 Ø14	35,850	100	1.200
CABA006	M6 Ø16	41,803	100	600
CABA008	M8 Ø20	72,680	100	400

Caja ventana

CÓDIGO	MEDIDA	€/CAJA	PCS	CAJAS
VCABA004	M4 Ø14	8,847	20	8
VCABA005	M5 Ø14	9,877	20	8
VCABA006	M6 Ø16	8,513	15	8

Bolsa autoservicio

CÓDIGO	MEDIDA	€/BOLSA	PCS	BOLSAS
LSCABA004	M4 Ø14	8,885	20	6
LSCABA005	M5 Ø14	9,581	20	6
LSCABA006	M6 Ø16	8,386	15	7

TAMBIÉN DISPONIBLE EN
easykits

NEW BA-NY

Nylon

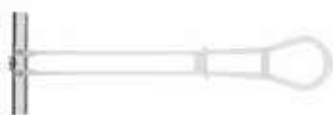

CÓDIGO	MEDIDA	€/100		
BANYM05	M5 Ø13	135,000	25	100
BANYM06	M6 Ø13	135,000	25	100

Palomilla con muelle

PA-LO



HUECOS



CÓDIGO	MEDIDA	€/100	UD. MIN. VENTA		
PAESM04	M4 Ø12	49,466	100	50	300
PAESM05	M5 Ø15	54,800	100	50	300
PAESM06	M6 Ø18	68,339	100	50	200
PAESM08	M8 Ø22	121,642	50	50	150

PA-ES

Espiga



Blíster

Caja ventana

Bolsa autoservicio

CÓDIGO	MEDIDA	€/BOLSA	PCS	BOLSAS
BZPAESM04	M4 Ø12	3,216	2	12
BZPAESM05	M5 Ø15	3,216	2	12
BZPAESM06	M6 Ø18	3,216	2	10

CÓDIGO	MEDIDA	€/CAJA	PCS	CAJAS
VPAESM04	M4 Ø12	4,780	6	8
VPAESM05	M5 Ø15	5,407	6	8
VPAESM06	M6 Ø18	4,577	4	8

CÓDIGO	MEDIDA	€/BOLSA	PCS	BOLSAS
LSPAESM04	M4 Ø12	4,430	6	6
LSPAESM05	M5 Ø15	5,054	6	6
LSPAESM06	M6 Ø18	4,240	4	6



HUECOS



CÓDIGO	MEDIDA	€/100	UD. MIN. VENTA		
PAGAM04	M4 Ø12	50,435	100	50	300
PAGAM05	M5 Ø15	57,594	100	50	300
PAGAM06	M6 Ø18	80,091	100	50	200
PAGAM08	M8 Ø22	134,469	50	50	150

PA-GA

Gancho



Blíster

Caja ventana

Bolsa autoservicio

CÓDIGO	MEDIDA	€/BOLSA	PCS	BOLSAS
BZPAGAM04	M4 Ø12	3,216	2	12
BZPAGAM05	M5 Ø15	3,216	2	12
BZPAGAM06	M6 Ø18	3,216	2	10

CÓDIGO	MEDIDA	€/CAJA	PCS	CAJAS
VPAGAM04	M4 Ø12	4,607	6	8
VPAGAM05	M5 Ø15	5,360	6	8
VPAGAM06	M6 Ø18	4,823	4	8

CÓDIGO	MEDIDA	€/BOLSA	PCS	BOLSAS
LSPAGAM04	M4 Ø12	4,648	6	6
LSPAGAM05	M5 Ø15	5,285	6	6
LSPAGAM06	M6 Ø18	4,972	4	6

HUECOS



CÓDIGO	MEDIDA	€/100		
CAPA004	M4 Ø12	19,334	100	2,400
CAPA005	M5 Ø15	21,933	100	1,200
CAPA006	M6 Ø18	26,374	100	600
CAPA008	M8 Ø22	58,029	100	400

CA-PA

Cabeza de palomilla



Caja ventana

Bolsa autoservicio

CÓDIGO	MEDIDA	€/CAJA	PCS	CAJAS
VCAPA004	M4 Ø12	6,832	24	8
VCAPA005	M5 Ø15	6,736	20	8
VCAPA006	M6 Ø18	6,182	15	8

CÓDIGO	MEDIDA	€/BOLSA	PCS	BOLSAS
LSCAPA004	M4 Ø12	6,451	24	8
LSCAPA005	M5 Ø15	6,357	20	7
LSCAPA006	M6 Ø18	5,610	15	7



IN

Anclaje Indemoll para fijación en elementos huecos

IN-CO

Con tornillo cabeza redonda



02
P. 406
Info
Técnica

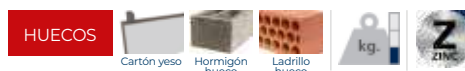

CÓDIGO	MEDIDA	€/100	ESPESOR MÁX. A FIJAR		
INCO421	M4 x 30 Ø 8	24,533	17 -hmin	100	2.400
INCO432	M4 x 41 Ø 8	26,243	22 -hmin	100	1.200
INCO438	M4 x 47 Ø 8	28,507	30 -hmin	100	1.200
INCO446	M4 x 53 Ø 8	31,010	33 -hmin	100	1.200
INCO459	M4 x 67 Ø 8	35,744	52 -hmin	100	1.200
INCO537	M5 x 46 Ø 10	37,520	26 -hmin	100	1.200
INCO552	M5 x 59 Ø 10	41,414	42 -hmin	100	600
INCO565	M5 x 72 Ø 10	49,165	55 -hmin	100	600
INCO580	M5 x 89 Ø 10	55,133	61 -hmin	100	600
INCO637	M6 x 46 Ø 12	44,038	25 -hmin	100	1.200
INCO652	M6 x 59 Ø 12	51,152	38 -hmin	100	600
INCO665	M6 x 72 Ø 12	57,005	49 -hmin	100	600
INCO680	M6 x 89 Ø 12	69,807	78 -hmin	100	600



Blíster

CÓDIGO	MEDIDA	€/BOLSA	PCS	BOLSAS
BZINCO432	M4 x 41 Ø 8	2,459	2	20
BZINCO438	M4 x 47 Ø 8	2,459	2	20
BZINCO537	M5 x 46 Ø 10	2,459	2	20
BZINCO552	M5 x 59 Ø 10	2,459	2	15
BZINCO565	M5 x 72 Ø 10	2,459	2	15
BZINCO637	M6 x 46 Ø 12	2,459	2	15
BZINCO652	M6 x 59 Ø 12	2,459	2	15



Caja ventana

CÓDIGO	MEDIDA	€/CAJA	PCS	CAJAS
VINCO432	M4 x 41 Ø 8	4,934	15	8
VINCO438	M4 x 47 Ø 8	5,335	15	8
VINCO446	M4 x 53 Ø 8	5,844	15	8
VINCO537	M5 x 46 Ø 10	6,787	15	8
VINCO552	M5 x 59 Ø 10	5,824	12	8
VINCO637	M6 x 46 Ø 12	5,129	10	8
VINCO652	M6 x 59 Ø 12	5,968	10	8



Bolsa autoservicio

CÓDIGO	MEDIDA	€/BOLSA	PCS	BOLSAS
LSINCO432	M4 x 41 Ø 8	8,902	30	6
LSINCO438	M4 x 47 Ø 8	9,667	30	6
LSINCO446	M4 x 53 Ø 8	10,519	30	6
LSINCO537	M5 x 46 Ø 10	10,179	25	6
LSINCO552	M5 x 59 Ø 10	7,856	18	7
LSINCO637	M6 x 46 Ø 12	9,286	20	7
LSINCO652	M6 x 59 Ø 12	8,090	15	7

IN-HE

Con tornillo cabeza hexagonal



02
P. 407
Info
Técnica



CÓDIGO	MEDIDA	€/100	ESPESOR MÁX. A FIJAR		
INHE837	M8 x 45 Ø 14	89,064	25 -hmin	100	600
INHE855	M8 x 60 Ø 14	102,453	36 -hmin	100	400
INHE865	M8 x 73 Ø 14	121,986	47 -hmin	100	400

IN-SI

Sin tornillo

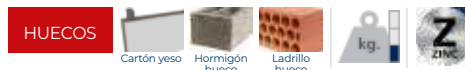

CÓDIGO	MEDIDA	€/100	ESPESOR MÁX. A FIJAR		
INSI421	M4 x 21 Ø 8	19,226	17 -hmin	100	2.400
INSI432	M4 x 32 Ø 8	21,570	22 -hmin	100	2.400
INSI438	M4 x 38 Ø 8	22,277	30 -hmin	100	2.400
INSI537	M5 x 37 Ø 10	28,272	26 -hmin	100	1.200
INSI552	M5 x 52 Ø 10	32,457	42 -hmin	100	600
INSI565	M5 x 65 Ø 10	35,997	55 -hmin	100	600
INSI637	M6 x 37 Ø 12	33,553	25 -hmin	100	1.200
INSI652	M6 x 52 Ø 12	40,980	38 -hmin	100	600
INSI665	M6 x 65 Ø 12	45,910	49 -hmin	100	600
INSI865	M8 x 65 Ø 14	81,453	47 -hmin	100	400

Anclaje Indemoll para fijación en elementos huecos

IN



CÓDIGO	€/100		
INPINZANI	1.646,767	1	20

INPIN

Pinza



CÓDIGO	€/100		
INPISANIN	3.474,087	1	10

INPIS

Pistola



CÓDIGO	COMPONENTES	MEDIDA COMPONENTES	UDS X KIT	€/KIT	KITS X 
KITINPINO1	INPINZANI	-	1	52,552	1
	INCO432	M4 x 41 Ø 8	20		
	INCO537	M5 x 46 Ø 10	20		

KITINPIN

Kit de tabiquería seca



ANCLA

Taco de nylon para ladrillos huecos y placas de yeso



02 Info. Técnica
P. 407

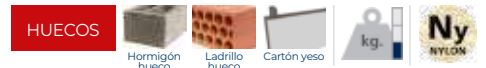

CÓDIGO	MEDIDA	€/100	UD. MIN. VENTA		
ANCLA40	10 x 40 Ø10	11,787	200	100	600
ANCLA47	10 x 47 Ø10	13,367	200	100	600

Blíster

CÓDIGO	MEDIDA	€/BOLSA	PCS	BOLSAS
BZANCLA40	10 x 40 Ø10	2,459	4	12
BZANCLA47	10 x 47 Ø10	2,459	4	12

TAPLA

Taco para placas de yeso laminado

TAPLA NY

Taco de nylon



02 Info. Técnica
P. 407



CÓDIGO	MEDIDA	VÁLIDO PARA	€/100		MÍN. ESPESOR MATERIAL BASE	UD. MIN. VENTA		
TAPLANY	15 x 33	TPPO 4,5 x 40 / DIN-7981 4,2 x 38	12,200	PH2/PH3	9-16	200	100	1.600

Blíster

CÓDIGO	MEDIDA	€/BOLSA	PCS	BOLSAS
BZTAPLANY	15 x 33	2,459	4	15

TAPLA ME

Taco de Zamak con tornillo DIN 7981 4,2 x 32



02 Info. Técnica
P. 407



CÓDIGO	MEDIDA	VÁLIDO PARA	€/100		MÍN. ESPESOR MATERIAL BASE	UD. MIN. VENTA		
TAPLAME	13 x 32	DIN-7981 4,2 x 32	31,087	PH2/PH3	9-16	200	100	1.600

Blíster

CÓDIGO	MEDIDA	€/BOLSA	PCS	BOLSAS
BZTAPLAME	13 x 32	3,216	4	15

TAPLA ZK

Taco de Zamak



02 Info. Técnica
P. 407



CÓDIGO	MEDIDA	VÁLIDO PARA	€/100		MÍN. ESPESOR MATERIAL BASE	UD. MIN. VENTA		
TAPLAZK	13 x 37	TPPO 4,5 x 50 / DIN-7981 4,2 x 38	34,237	PH3	9-16	200	100	1.600



REMACCHES



RE-NO

Cabeza alomada. Aluminio



CÓDIGO	MEDIDA	€/100	Ø BROCA	ESPEJOR MÁX. A FIJAR		
RENO3206	3,2 x 6	3,900	3,3	1-3	500	12.000
RENO3208	3,2 x 8	4,064	3,3	3-5	500	12.000
RENO3210	3,2 x 10	4,573	3,3	5-7	500	6.000
RENO3212	3,2 x 12	4,907	3,3	7-9	500	6.000
RENO3214	3,2 x 14	5,327	3,3	9-11	500	6.000
RENO3216	3,2 x 16	5,900	3,3	11-13	500	6.000
RENO3218	3,2 x 18	6,820	3,3	13-15	500	6.000
RENO4006	4 x 6	4,323	4,1	0,5-2	500	6.000
RENO4008	4 x 8	4,657	4,1	2-4	500	6.000
RENO4010	4 x 10	5,373	4,1	4-6	500	6.000
RENO4012	4 x 12	5,877	4,1	6-8	500	6.000
RENO4014	4 x 14	6,633	4,1	8-10	500	6.000
RENO4016	4 x 16	6,923	4,1	10-12	500	6.000
RENO4018	4 x 18	7,397	4,1	12-14	500	3.000
RENO4020	4 x 20	7,643	4,1	14-16	500	6.000
RENO4025	4 x 25	9,953	4,1	16-18	250	3.000
RENO4030	4 x 30	11,583	4,1	23-16	250	3.000
RENO4035	4 x 35	14,517	4,1	26-30	250	3.000
RENO4806	4,8 x 6	5,670	5	0,5-1,5	500	6.000
RENO4808	4,8 x 8	6,680	5	1,5-3,5	500	6.000
RENO4810	4,8 x 10	7,020	5	3,5-5,5	500	3.000
RENO4812	4,8 x 12	7,397	5	5,5-7,5	500	3.000
RENO4814	4,8 x 14	8,467	5	7,5-9,5	250	3.000
RENO4816	4,8 x 16	9,187	5	9,5-11,5	250	3.000
RENO4818	4,8 x 18	10,483	5	11,5-13,5	250	3.000
RENO4820	4,8 x 20	11,287	5	13,5-15	250	3.000
RENO4822	4,8 x 22	12,397	5	15-17	200	2.400
RENO4824	4,8 x 24	12,587	5	17-19	200	2.400
RENO4826	4,8 x 26	13,517	5	19-21	200	2.400
RENO4828	4,8 x 28	14,377	5	21-23	200	2.400
RENO4830	4,8 x 30	15,180	5	23-25	200	2.400
RENO4835	4,8 x 35	16,687	5	25-30	150	1.800
RENO6008	6 x 8	15,617	6,1	1-2	250	3.000
RENO6010	6 x 10	14,707	6,1	2-4	250	3.000
RENO6012	6 x 12	15,097	6,1	3-6	250	3.000
RENO6018	6 x 18	17,197	6,1	6-10	200	1.200
RENO6025	6 x 25	21,190	6,1	10-12	200	1.200
RENO6016	6 x 16	16,543	6,1	15-19	250	1.500

Blíster

CÓDIGO	MEDIDA	€/BOLSA	PCS	BOLSAS
BZRENO3208	3,2 x 8	1,943	15	20
BZRENO3210	3,2 x 10	1,943	15	20
BZRENO4008	4 x 8	1,943	15	20
BZRENO4010	4 x 10	1,943	15	20
BZRENO4012	4 x 12	1,943	15	20
BZRENO4016	4 x 16	1,943	15	20
BZRENO4810	4,8 x 10	1,943	15	20
BZRENO4812	4,8 x 12	1,943	15	20
BZRENO4816	4,8 x 16	1,943	8	20
BZRENO4820	4,8 x 20	1,943	8	20
BZRENO4824	4,8 x 24	1,943	8	20



Caja ventana

CÓDIGO	MEDIDA	€/CAJA	PCS	CAJAS
VRENO3206	3,2 x 6	3,010	50	8
VRENO3208	3,2 x 8	3,073	50	8
VRENO3210	3,2 x 10	3,097	50	8
VRENO3212	3,2 x 12	3,483	50	8
VRENO3214	3,2 x 14	3,610	50	8
VRENO3218	3,2 x 18	4,573	50	8
VRENO4006	4 x 6	3,262	50	8
VRENO4008	4 x 8	3,276	50	8
VRENO4010	4 x 10	3,503	50	8
VRENO4012	4 x 12	3,820	50	8
VRENO4014	4 x 14	4,317	50	8
VRENO4016	4 x 16	4,503	50	8
VRENO4018	4 x 18	4,810	50	8
VRENO4020	4 x 20	4,970	50	8
VRENO4808	4,8 x 8	4,437	50	8
VRENO4810	4,8 x 10	4,567	50	8
VRENO4812	4,8 x 12	4,810	50	8
VRENO4814	4,8 x 14	5,507	50	8
VRENO4816	4,8 x 16	5,973	50	8
VRENO4818	4,8 x 18	6,817	50	8
VRENO4820	4,8 x 20	7,347	50	8
VRENO4822	4,8 x 22	4,033	25	8
VRENO4824	4,8 x 24	4,097	25	8
VRENO4830	4,8 x 30	4,940	25	8
VRENO4835	4,8 x 35	5,430	25	8

Remaches

RE



CÓDIGO	MEDIDA	€/100	Ø BROCA	ESPEJOR MÁX. A FIJAR		
REIN3206	3,2 x 6,4	15,697	3,3	0,5 - 3	500	6.000
REIN3208	3,2 x 8	16,793	3,3	3 - 5	500	6.000
REIN3212	3,2 x 12,7	24,747	3,3	6,5 - 8,5	500	6.000
REIN3215	3,2 x 15,9	29,900	3,3	10,5 - 12,5	500	6.000
REIN4008	4 x 8,5	28,190	4,1	2,5 - 4,5	500	6.000
REIN4010	4 x 10,2	29,997	4,1	4,5 - 6,5	500	6.000
REIN4012	4 x 12	33,997	4,1	6,5 - 8,5	500	6.000
REIN4016	4 x 16	41,163	4,1	10 - 12	500	3.000
REIN4810	4,8 x 10,8	41,473	5	4 - 6	500	3.000
REIN4812	4,8 x 12	45,333	5	6 - 8	500	3.000
REIN4816	4,8 x 16	55,733	5	8 - 11	250	3.000
REIN4820	4,8 x 20,3	78,197	5	11 - 13	250	3.000
REIN4818	4,8 x 18	59,590	5	13 - 15	250	3.000

RE-IN

Cabeza alomada. Acero inoxidable A2



CÓDIGO	MEDIDA	€/100	Ø BROCA	ESPEJOR MÁX. A FIJAR		
RECA4008	4 x 8	6,913	4,1	2 - 4	500	3.000
RECA4010	4 x 10	7,493	4,1	4 - 6	500	3.000
RECA4012	4 x 12	8,833	4,1	6 - 8	250	3.000
RECA4016	4 x 16	10,093	4,1	10 - 12	250	3.000
RECA4810	4,8 x 10	10,773	5	3,5 - 5,5	250	3.000
RECA4812	4,8 x 12	11,307	5	5,5 - 7,5	250	3.000
RECA4814	4,8 x 14	12,273	5	7,5 - 9,5	250	3.000
RECA4816	4,8 x 16	13,137	5	9,5 - 11,5	250	1.500
RECA4818	4,8 x 18	14,000	5	11,5 - 13,5	200	2.400

RE-CA

Cabeza ancha. Aluminio



 Blíster

CÓDIGO	MEDIDA	€/BOLSA	PCS B	BOLSAS
BZRECA4010	4 x 10	1,943	8	15
BZRECA4012	4 x 12	1,943	8	15
BZRECA4016	4 x 16	1,943	8	15
BZRECA4810	4,8 x 10	1,943	8	15
BZRECA4812	4,8 x 12	1,943	8	15
BZRECA4814	4,8 x 14	1,943	8	15
BZRECA4816	4,8 x 16	1,943	8	15
BZRECA4818	4,8 x 18	1,943	5	15

 Caja ventana

CÓDIGO	MEDIDA	€/CAJA	PCS C	CAJAS
VRECA4010	4 x 10	4,692	50	8
VRECA4012	4 x 12	3,996	35	8
VRECA4016	4 x 16	4,478	35	8
VRECA4810	4,8 x 10	3,670	25	8
VRECA4812	4,8 x 12	3,692	25	8
VRECA4814	4,8 x 14	4,187	25	8
VRECA4816	4,8 x 16	4,375	25	8
VRECA4818	4,8 x 18	3,809	20	8



CÓDIGO	MEDIDA	€/100	Ø BROCA	ESPEJOR MÁX. A FIJAR		
RENO3208BL	3,2 x 8 9003	7,590	3,3	3,5 - 5	500	6.000
RENO3210BL	3,2 x 10 9003	8,023	3,3	5 - 7	500	6.000
RENO3212BL	3,2 x 12 9003	8,417	3,3	7 - 9	500	6.000
RENO4008BL	4 x 8 9003	9,247	4,1	3 - 5	500	6.000
RENO4010BL	4 x 10 9003	10,007	4,1	5 - 6,5	500	6.000
RENO4012BL	4 x 12 9003	10,370	4,1	6,5 - 8,5	500	6.000
RENO4014BL	4 x 14 9003	11,400	4,1	8,5 - 10,5	500	6.000
RENO4810BL	4,8 x 10 9003	13,703	4,9	4 - 6	500	3.000
RENO4812BL	4,8 x 12 9003	14,410	4,9	6 - 8	500	3.000
RENO4814BL	4,8 x 14 9003	15,723	4,9	8 - 10	250	3.000
RENO4816BL	4,8 x 16 9003	16,363	4,9	10 - 12	250	3.000

RE-BL

Cabeza alomada blanca. Aluminio



RE

Remaches

RE-NE

Cabeza alomada negra. Aluminio



CÓDIGO	MEDIDA	€/100	Ø BROCA	ESPEJOR MÁX. A FIJAR		
RENO3208NE	3,2 x 8 9005	7,590	3,3	3,5-5	500	6.000
RENO3210NE	3,2 x 10 9005	8,023	3,3	5-7	500	6.000
RENO3212NE	3,2 x 12 9005	8,417	3,3	7-9	500	6.000
RENO4008NE	4 x 8 9005	9,247	4,1	3-5	500	6.000
RENO4010NE	4 x 10 9005	10,007	4,1	5-6,5	500	6.000
RENO4012NE	4 x 12 9005	10,370	4	6,5-8,5	500	6.000
RENO4014NE	4 x 14 9005	11,400	4,1	8,5-10,5	500	6.000
RENO4810NE	4,8 x 10 9005	13,703	4,9	4-6	500	3.000
RENO4812NE	4,8 x 12 9005	14,410	4,9	6-8	500	3.000
RENO4814NE	4,8 x 14 9005	15,723	4,9	8-10	250	3.000
RENO4816NE	4,8 x 16 9005	16,363	4,9	10-12	250	3.000

RE-FL

Cabeza alomada. Flor



CÓDIGO	MEDIDA	€/100	Ø BROCA	ESPEJOR MÁX. A FIJAR		
REFL4012	4 x 12,1	9,880	4,1	4-6,5	500	6.000
REFL4014	4 x 13,9	11,190	4,1	6-9	500	3.000
REFL4016	4 x 15,7	11,730	4,1	8-11	500	3.000
REFL4018	4 x 17,4	12,173	4,1	10-13	500	3.000
REFL4020	4 x 19,2	12,793	4,1	12-15	500	3.000
REFL4814	4,8 x 14,5	15,153	5	4-8	250	3.000
REFL4816	4,8 x 16,3	16,020	5	6-10	250	3.000
REFL4830	4,8 x 30	24,650	5	19-24	200	1.200
REFL4835	4,8 x 35	28,543	5	24-29	150	1.800
REFL4840	4,8 x 40	33,057	5	29-34	150	1.800
REFL4845	4,8 x 45	43,907	5	-	150	900
REFL4850	4,8 x 50	45,883	5	-	150	900
REFL4818	4,8 x 18	18,200	5	8-12	250	3.000
REFL4824	4,8 x 24	21,473	5	15-18	200	2.400
REFL4025	4 x 25	16,410	4,1	15-20	250	3.000

Blíster



CÓDIGO	MEDIDA	€/BOLSA	PCS	BOLSAS
BZREFL4835	4,8 x 35	1,943	5	20

Caja ventana

CÓDIGO	MEDIDA	€/CAJA	PCS	CAJAS
VREFL4835	4,8 x 35	8,696	25	8

Tuercas remachables

TR



CÓDIGO	MEDIDA	€/100		
TRAV0411	M4 x 11	14,127	500	12.000
TRAV0513	M5 x 13	15,150	500	6.000
TRAV0616	M6 x 16	18,933	500	3.000
TRAV0819	M8 x 19	22,157	250	3.000
TRAV1021	M10 x 21	33,773	250	1.500



TR-AV

Cabeza avellanada





CÓDIGO	MEDIDA	€/100		
TRCA0310	M3 x 10	9,840	500	12.000
TRCA0410	M4 x 10	20,510	500	12.000
TRCA0411	M4 x 11	20,510	500	12.000
TRCA0512	M5 x 12	22,023	500	12.000
TRCA0515	M5 x 15	22,023	500	6.000
TRCA0614	M6 x 14	27,620	250	3.000
TRCA0616	M6 x 16	27,620	250	3.000
TRCA0816	M8 x 16	20,447	250	3.000
TRCA0818	M8 x 18	21,153	250	1.500
TRCA1017	M10 x 17	33,783	250	1.500
TRCA1022	M10 x 22	34,967	250	1.500
TRCA1223	M12 x 23	56,623	250	1.000



TR-CA

Cabeza ancha



CÓDIGO	MEDIDA	€/100		
TRCR0410	M4 x 10	20,493	500	12.000
TRCR0511	M5 x 11	20,707	500	12.000
TRCR0614	M6 x 14	25,927	250	6.000
TRCR0815	M8 x 15	30,183	250	3.000
TRCR1019	M10 x 19	30,267	250	1.500



TR-CR

Cabeza reducida



RM

Remachadoras

RM-MA

Remachadora manual alicate



METAL

CÓDIGO	VÁLIDO PARA	€/PC		
RMMA01	Ø2,4 / Ø3,2 / Ø4,0 / Ø4,8	29,015	1	40

RM-PA

Remachadora manual palanca



METAL

CÓDIGO	VÁLIDO PARA	€/PC		
RMPA01	Ø3,2 / Ø4,0 / Ø4,8 / Ø6,0 / Ø6,4	189,563	1	10

RM-EX

Remachadora manual extensible



METAL

CÓDIGO	VÁLIDO PARA	€/PC		
RMEX01	Ø3,2 / Ø4,0 / Ø4,8 / Ø6,0 / Ø6,4	176,537	1	5



ACCESORIOS PARA CABLE CADENA Y CERCADOS

U

SJ

Sujetacable DIN 741

SJ-Z

Cincado



METAL



CÓDIGO	MÉTRICA	Ø CABLE	€/100		
SJZ0403	M4	M4(Ø3)	26,393	200	2.400
SJZ0505	M5	M5(Ø5)	30,807	200	1.200
SJZ0506	M5	M5(Ø6 - 6,5)	36,243	100	1.200
SJZ0608	M6	M6(Ø8)	55,527	100	600
SJZ0810	M8	M8(Ø10)	87,340	100	400
SJZ0811	M8	M8(Ø11)	96,943	100	400
SJZ1013	M10	M10(Ø13)	163,200	50	150
SJZ1014	M10	M10(Ø14)	172,840	50	200
SJZ1216	M12	M12(Ø16)	260,707	50	100
SJZ1220	M12	M12(Ø20)	341,727	25	75
SJZ1422	M14	M14(Ø22)	474,423	15	45
SJZ1426	M14	M14(Ø26)	584,283	15	45
SJZ1630	M16	M16(Ø30)	856,617	10	30
SJZ1634	M16	M16(Ø34)	1.118,100	10	20
SJZ1640	M16	M16(Ø40)	1.392,933	5	15
SJZ1845	NEW M18	M18(Ø45)	2.798,463	5	-
SJZ2050	NEW M20	M20(Ø50)	3.191,740	5	-

Blisters

CÓDIGO	MEDIDA	€/BOLSA	PCS	BOLSAS
BZSJZ0403	M4(Ø3)	4,463	4	20
BZSJZ0505	M5(Ø5)	4,463	2	20
BZSJZ0506	M5(Ø6 - 6,5)	4,463	2	20
BZSJZ0608	M6(Ø8)	4,463	2	20

NEW SJ-A4

Inoxidable A4



METAL



CÓDIGO	MÉTRICA	Ø CABLE	€/100		
SJA42103	M4	M4(Ø3)	195,100	50	1.200
SJA42305	M5	M5(Ø5)	257,000	40	960
SJA42606	M5	M5(Ø6)	280,800	20	900
SJA43008	M6	M6(Ø8)	295,100	20	480
SJA43410	M8	M8(Ø10)	523,500	10	240
SJA43611	M8	M8(Ø11)	761,500	10	240
SJA44414	M10	M10(Ø14)	894,800	5	225
SJA45016	M12	M12(Ø16)	1.423,000	5	120
SJA45418	M12	M12(Ø18)	2.141,700	5	80
SJA46122	M14	M14(Ø22)	3.036,500	1	45
SJA46525	M14	M14(Ø25)	3.402,900	1	24

NEW SJ-O

Sujetacable oval. Cincado



METAL



CÓDIGO	MÉTRICA	Ø CABLE	€/100		
SJ00502	M5	M5(Ø2)	89,613	100	1.200
SJ00503	M5	M5(Ø3)	93,880	100	1.200
SJ00604	M6	M6(Ø4)	168,557	100	600
SJ00605	M6	M6(Ø5)	183,490	100	600
SJ00606	M6	M6(Ø6)	199,280	25	600

Sujetacable plano

SJ-P

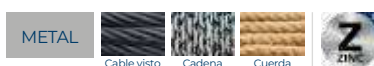

CÓDIGO	MÉTRICA	Ø CABLE	€/100		
SJPS0402	M4	M4(Ø2)	22,190	100	4.500
SJPS0403	M4	M4(Ø3)	22,617	100	2.400
SJPS0504	M5	M5(Ø4)	29,870	100	2.400
SJPS0605	M6	M6(Ø5)	42,673	100	1.200
SJPS0606	M6	M6(Ø6)	59,743	50	600

SJ-PS NEW

Simple. Cincado



CÓDIGO	MÉTRICA	Ø CABLE	€/100		
SJPSA40403	M4	M4(Ø3)	99,947	30	1.350
SJPSA40504	M5	M5(Ø4)	147,540	30	1.350
SJPSA40605	M6	M6(Ø5)	204,650	20	900
SJPSA40606	M6	M6(Ø6)	347,430	10	450

SJ-PS A4 NEW

Simple. Inoxidable A4

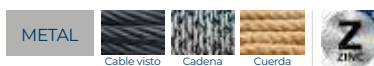

CÓDIGO	MÉTRICA	Ø CABLE	€/100		
SJPD0402	M4	M4(Ø2)	33,070	100	2.400
SJPD0403	M4	M4(Ø3)	40,113	100	1.200
SJPD0504	M5	M5(Ø4)	50,993	100	1.200
SJPD0605	M5	M5(Ø5)	70,410	50	600
SJPD0606	M6	M6(Ø6)	108,813	50	300
SJPD0808	M8	M8(Ø8)	185,627	25	150

SJ-PD NEW

Doble. Cincado

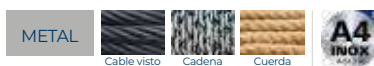

CÓDIGO	MÉTRICA	Ø CABLE	€/100		
SJPDA40403	M4	M4(Ø3)	166,577	30	720
SJPDA40504	M5	M5(Ø4)	271,283	30	720
SJPDA40605	M5	M5(Ø5)	337,913	20	480
SJPDA40606	M6	M6(Ø6)	585,397	10	240

SJ-PD A4 NEW

Doble. Inoxidable A4



TS-GA

Tensor gancho/anilla DIN-1480

TS-GA

Zincado



METAL

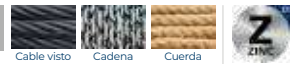

CÓDIGO	MÉTRICA	Ø CABLE	€/100		
TSGA06	M6	M6(Ø10)	261,977	50	200
TSGA08	M8	M8(Ø11)	338,847	25	100
TSGA10	M10	M10(Ø14)	490,620	25	75
TSGA12	M12	M12(Ø17)	728,280	10	20
TSGA14	M14	M14(Ø18)	957,217	10	20
TSGA16	M16	M16(Ø23)	1.442,193	10	20
TSGA20	M20	M20(Ø25)	2.477,160	5	-
TSGA22	M22	M22(Ø30)	3.458,780	1	-
TSGA24	M24	M24(Ø34)	4.600,223	1	-
TSGA30	M30	M30(Ø38)	8.266,723	1	-
TSGA36	M36	M36(Ø48)	25.254,960	1	-
TSGA05	NEW M5	M5(Ø8)	179,967	50	300

Blíster

CÓDIGO	MEDIDA	€/BOLSA	PCS BOLSA	BOLSAS
BZTSGA06	M6(Ø10)	4,463	1	20

NEW TS-GA A4

Inoxidable A4



METAL

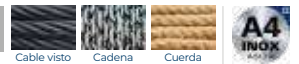

CÓDIGO	MÉTRICA	Ø CABLE	€/100		
TSGAA405	M5	M5(Ø8)	493,900	10	240
TSGAA406	M6	M6(Ø10)	692,500	10	120
TSGAA410	M10	M10(Ø14)	1.800,400	5	30
TSGAA412	M12	M12(Ø17)	3.393,200	5	30

TS-AA

Tensor anilla/anilla DIN-1480

NEW TS-AA

Cincado



METAL

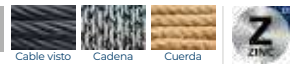

CÓDIGO	MÉTRICA	Ø CABLE	€/100		
TSAA05	M5	M5(Ø8)	179,967	50	300
TSAA06	M6	M6(Ø10)	261,977	50	200
TSAA08	M8	M8(Ø11)	338,847	25	100
TSAA10	M10	M10(Ø14)	490,620	25	75
TSAA12	M12	M12(Ø17)	728,280	10	30
TSAA14	M14	M14(Ø18)	957,217	10	20
TSAA16	M16	M16(Ø23)	1.442,193	10	20
TSAA20	M20	M20(Ø25)	2.477,160	5	10
TSAA22	M22	M22(Ø30)	3.458,780	1	-
TSAA24	M24	M24(Ø34)	4.600,223	1	-
TSAA30	M30	M30(Ø39)	8.266,723	1	-
TSAA36	M36	M36(Ø49)	25.254,960	1	-

NEW TS-AA A4

Inoxidable A4



METAL

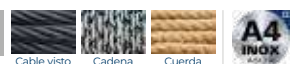

CÓDIGO	MÉTRICA	Ø CABLE	€/100		
TSAAA410	M10	M10(Ø14)	1.856,100	5	20
TSAAA412	M12	M12(Ø17)	3.498,100	5	20
TSAAA405	M5	M5(Ø8)	509,200	10	240
TSAAA406	M6	M6(Ø10)	713,900	10	120
TSAAA408	M8	M8(Ø11)	1.251,700	10	60

Tensor gancho/gancho DIN-1480

TS-GG

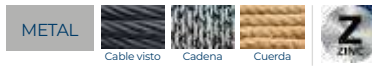

TS-GG NEW

Cincado

CÓDIGO	MÉTRICA	Ø CABLE	€/100		
TSGG05	M5	M5(Ø7)	179,900	50	300
TSGG06	M6	M6(Ø8)	262,000	50	200
TSGG08	M8	M8(Ø9.5)	338,800	25	75
TSGG10	M10	M10(Ø12)	490,600	25	75
TSGG12	M12	M12(Ø15)	728,300	10	20
TSGG14	M14	M14(Ø17)	957,200	10	20
TSGG16	M16	M16(Ø19)	1.442,200	10	20
TSGG20	M20	M20(Ø20)	2.477,200	5	-
TSGG22	M22	M22(Ø23)	3.458,800	1	-
TSGG24	M24	M24(Ø25)	4.600,200	1	-
TSGG30	M30	M30(Ø31)	8.266,700	1	-
TSGG36	M36	M36(Ø44)	25.254,900	1	-

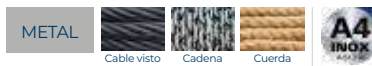

TS-GG A4 NEW

Inoxidable A4

CÓDIGO	MÉTRICA	Ø CABLE	€/100		
TSGGA405	M5	M5(Ø7)	509,200	10	240
TSGGA406	M6	M6(Ø8)	713,900	10	120
TSGGA408	M8	M8(Ø9.5)	1.251,700	10	-
TSGGA410	M10	M10(Ø12)	1.856,100	5	20
TSGGA412	M12	M12(Ø15)	3.498,100	5	15



Tensor varilla soldar

TS-VS

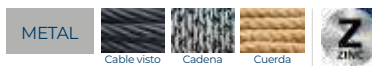

NEW

CÓDIGO	MÉTRICA	Ø CABLE	€/100		
TSVS06	M6	M6(Ø9)	251,900	50	100
TSVS08	M8	M8(Ø11)	305,900	25	50
TSVS10	M10	M10(Ø13)	467,900	25	50
TSVS12	M12	M12(Ø16)	652,400	25	50
TSVS14	M12	M12(Ø20)	904,300	10	20
TSVS16	M16	M16(Ø24)	1.340,700	10	-
TSVS20	M20	M20(Ø17)	2.303,600	1	-
TSVS22	M22	M22(Ø26)	3.032,400	1	-
TSVS24	M24	M24(Ø28)	4.211,300	1	-
TSVS30	M30	M30(Ø34)	6.523,800	1	-
TSVS36	M36	M36(Ø39)	13.947,400	1	-



EV-H

Cáncamo hembra D-582

EV-H

Cincado



METAL



CÓDIGO	MÉTRICA	Ø CABLE	€/100		
EVH06	M6	M6(Ø20)	152,990	100	400
EVH08	M8	M8(Ø20)	160,813	100	400
EVH10	M10	M10(Ø25)	228,030	100	200
EVH12	M12	M12(Ø30)	281,613	100	-
EVH14	M14	M14(Ø35)	426,820	50	150
EVH16	M16	M16(Ø35)	485,660	50	100
EVH18	M18	M18(Ø40)	677,503	50	-
EVH20	M20	M20(Ø40)	680,927	50	-
EVH22	M22	M22(Ø45)	1.075,697	25	50
EVH24	M24	M24(Ø50)	1.368,373	25	-
EVH30	M30	M30(Ø60)	2.804,813	10	20
EVH36	M36	M36(Ø70)	4.494,330	1	-
EVH27	NEW M28	M28(Ø53)	2.560,360	10	-
EVH42	NEW M42	M42(Ø80)	6.400,900	1	-
EVH48	NEW M48	M48(Ø90)	9.814,713	1	-

NEW EV-H A4

Inoxidable A4



METAL



CÓDIGO	MÉTRICA	Ø CABLE	€/100		
EVHA406	M6	M6(Ø15)	209,410	10	450
EVHA408	M8	M8(Ø20)	337,913	10	450
EVHA410	M10	M10(Ø25)	642,510	10	240
EVHA412	M12	M12(Ø30)	951,867	5	120
EVHA414	M14	M14(Ø30)	1.427,800	5	120
EVHA416	M16	M16(Ø35)	1.665,767	1	-
EVHA420	M20	M20(Ø38)	2.189,293	1	-
EVHA424	M24	M24(Ø50)	4.759,333	1	24

EV-M

Cáncamo macho D-580

EV-M

Cincado



METAL



CÓDIGO	MÉTRICA	Ø CABLE	€/100		
EVM06	M6	M6 (Ø20)	152,990	100	400
EVM08	M8	M8 (Ø20)	160,813	100	400
EVM10	M10	M10 (Ø25)	228,030	100	200
EVM12	M12	M12 (Ø30)	281,613	50	100
EVM14	M14	M14 (Ø35)	426,820	50	100
EVM16	M16	M16 (Ø35)	485,660	50	-
EVM18	M18	M18 (Ø40)	677,503	50	-
EVM20	M20	M20 (Ø40)	680,927	25	50
EVM22	M22	M22 (Ø45)	1.075,697	25	50
EVM24	M24	M24 (Ø50)	1.368,373	25	-
EVM30	M30	M30 (Ø60)	2.804,813	10	-
EVM36	M36	M36 (Ø70)	4.494,330	1	-
EVM42	M42	M42 (Ø80)	6.400,900	1	-
EVM48	M48	M48 (Ø90)	9.814,713	1	-
EVM27	NEW M27	M27 (Ø55)	2.560,360	10	-
EVM33	NEW M33	M33 (Ø65)	3.840,540	1	-

NEW EV-M A4

Inoxidable A4



METAL



CÓDIGO	MÉTRICA	Ø CABLE	€/100		
EVMA406	M6	M6 (Ø20)	223,690	10	450
EVMA408	M8	M8 (Ø20)	385,507	10	450
EVMA410	M10	M10 (Ø25)	690,103	10	240
EVMA412	M12	M12(Ø30)	1.047,053	5	120
EVMA414	M14	M14 (Ø35)	1.546,783	5	120
EVMA416	M16	M16 (Ø35)	1.808,547	1	45
EVMA420	M20	M20 (Ø40)	2.617,633	1	-
EVMA424	M24	M24(Ø50)	5.711,200	1	12

Grillete recto

GR

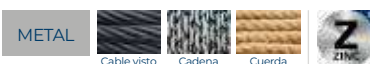

GR-Z

Cincado

CÓDIGO	MÉTRICA	Ø CABLE	€/100		
GRZ05	M5	M5(Ø10)	86,997	50	1.200
GRZ06	M6	M6(Ø12)	91,327	50	600
GRZ08	M8	M8(Ø16)	121,420	50	300
GRZ10	M10	M10(Ø19)	167,723	50	200
GRZ11	M11	M11(Ø22)	266,410	25	150
GRZ12	M12	M12(Ø25)	269,417	25	100
GRZ14	M14	M14(Ø28)	413,093	25	75
GRZ16	M16	M16(Ø32)	557,123	10	40
GRZ18	M18	M18(Ø36)	846,557	5	30
GRZ20	M20	M20(Ø38)	932,640	5	20
GRZ22	M22	M22(Ø44)	1.321,643	1	-
GRZ25	M25	M25(Ø50)	1.933,293	1	-
GRZ28	M28	M28(Ø56)	2.904,593	1	-
GRZ32	M32	M32(Ø64)	4.744,220	1	-
GRZ36	M36	M36(Ø70)	8.115,530	1	-
GRZ38	NEW M38	M38(Ø76)	7.254,353	1	-
GRZ42	M42	M42(Ø76)	15.180,280	1	-
GRZ45	M45	M45(Ø80)	20.177,233	1	-
GRZ50	M50	M50(Ø90)	26.493,083	1	-
GRZ56	NEW M56	M56(Ø100)	48.646,840	1	-
GRZ63	NEW M63	M63(Ø110)	79.584,523	1	-



Blíster

CÓDIGO	MEDIDA	€/BOLSA	PCS	BOLSAS
BZGRZ05	M5(Ø10)	4,463	4	20
BZGRZ06	M6(Ø12)	4,463	4	20
BZGRZ08	M8(Ø16)	4,463	2	20
BZGRZ10	M10(Ø19)	4,463	1	20

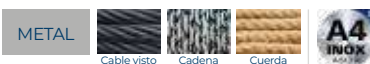

GR-A4 NEW

Inoxidable A4

CÓDIGO	MÉTRICA	Ø CABLE	€/100		
GRA404	M4	M4(Ø08)	209,410	25	1.125
GRA405	M5	M5(Ø10)	228,447	25	1.125
GRA406	M6	M6(Ø12)	261,763	25	600
GRA408	M8	M8(Ø16)	390,267	10	240
GRA410	M10	M10(Ø19)	628,233	10	120
GRA412	M12	M12(Ø25)	989,940	5	60
GRA414	M14	M14(Ø28)	1.594,377	5	60
GRA416	M16	M16(Ø32)	2.284,480	5	40
GRA419	M20	M20(Ø38)	4.473,773	1	-
GRA425	M25	M25(Ø50)	9.613,853	1	-



GD

Guardacabo DIN-6899/A

GD-Z

Cincado



CÓDIGO	MÉTRICA	Ø CABLE	€/100		
GDZ03	M3	M3(Ø12)	32,910	200	2.400
GDZ04	M4	M4(Ø13)	33,670	200	1.200
GDZ05	M5	M5(Ø14)	38,317	200	600
GDZ06	M6	M6(Ø15)	43,040	200	-
GDZ08	M8	M8(Ø18)	52,730	100	200
GDZ10	M10	M10(Ø22)	73,770	100	200
GDZ13	M13	M13(Ø28)	162,117	50	-
GDZ15	M15	M15(Ø32)	234,100	50	-
GDZ18	M18	M18(Ø40)	541,193	50	-
GDZ20	M20	M20(Ø44)	778,317	25	-
GDZ24	M24	M24(Ø48)	967,293	10	20
GDZ12	NEW M12	M12(Ø26)	98,150	100	200

Blíster

CÓDIGO	MEDIDA	€/BOLSA	PCS BLÍSTER	BOLSAS
BZGDZ03	M3(Ø12)	4,463	6	20
BZGDZ04	M4(Ø13)	4,463	4	20
BZGDZ05	M5(Ø14)	4,463	4	20
BZGDZ06	M6(Ø15)	4,463	4	20

NEW GD-A4

Inoxidable A4



CÓDIGO	MÉTRICA	Ø CABLE	€/100		
GDA402	M2	M2(Ø10)	39,503	100	4.500
GDA403	M3	M3(Ø12)	57,113	100	4.500
GDA404	M4	M4(Ø13)	66,630	50	2.250
GDA405	M5	M5(Ø14)	90,427	50	1.200
GDA406	M6	M6(Ø15)	104,707	50	1.200
GDA408	M8	M8(Ø18)	199,893	50	600
GDA410	M10	M10(Ø22)	328,393	25	300
GDA412	M12	M12(Ø26)	385,507	10	120
GDA415	M15	M15(Ø32)	666,307	5	60

NEW GI-Z

Zincado



CÓDIGO	MÉTRICA	Ø CABLE	€/100		
GIZ05	M5	M5(Ø8)	64,010	50	1.200
GIZ06	M6	M6(Ø10)	68,277	50	600
GIZ08	M8	M8(Ø12)	110,950	50	300
GIZ10	M10	M10(Ø16)	174,960	50	200
GIZ11	M11	M11(Ø19)	234,697	25	150
GIZ12	M12	M12(Ø28)	264,570	25	100
GIZ14	M14	M14(Ø33)	409,657	10	60
GIZ16	M16	M16(Ø37)	567,543	10	40
GIZ20	M20	M20(Ø40)	1.024,143	5	30
GIZ22	M22	M22(Ø47)	1.365,527	1	45
GIZ25	M25	M25(Ø52)	1.920,270	1	-
GIZ28	M28	M28(Ø63)	2.901,740	1	-
GIZ32	M32	M32(Ø75)	4.736,667	1	-
GIZ36	M36	M36(Ø78)	6.336,893	1	-

Crillete lira

GI

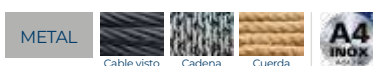

GI-A4 NEW

Inoxidable A4



CÓDIGO	MÉTRICA	Ø CABLE	€/100		
GIA404	M4	M4(Ø6)	266,523	25	1.125
GIA405	M5	M5(Ø8)	290,320	25	1.125
GIA406	M6	M6(Ø10)	318,877	10	450
GIA408	M8	M8(Ø12)	475,933	10	240
GIA410	M10	M10(Ø16)	785,290	10	120
GIA412	M12	M12(Ø28)	1.237,427	5	60
GIA414	M14	M14(Ø33)	2.141,700	5	60
GIA416	M16	M16(Ø37)	2.926,990	5	30

Ese cincada

GS NEW

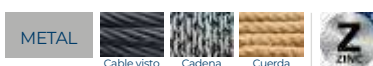

CÓDIGO	MÉTRICA	Ø CABLE	€/100		
GSZ0325	M3	M3(Ø8)	10,670	200	4.800
GSZ0435	M4	M4(Ø10)	12,373	200	2.400
GSZ0545	M5	M5(Ø13)	22,617	200	1.200
GSZ0655	M6	M6(Ø15)	34,563	100	600
GSZ0765	M7	M7(Ø20)	65,717	50	300
GSZ0875	M8	M8(Ø22)	96,013	50	300
GSZ1010	M10	M10(Ø25)	168,557	25	150

Mosquetón bombero

MQ

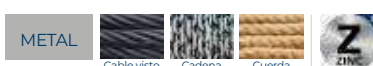

MQ-BS NEW

Con seguro



CÓDIGO	MÉTRICA	Ø CABLE	€/100		
MQBS04	M4	M4(Ø6)	98,150	200	2.400
MQBS06	M6	M6(Ø9)	128,017	100	600
MQBS07	M7	M7(Ø10)	157,887	100	400
MQBS08	M8	M8(Ø12)	174,960	50	300
MQBS09	M9	M9(Ø15)	243,237	25	150
MQBS10	M10	M10(Ø14,7)	294,443	25	150
MQBS11	M11	M11(Ø18)	401,123	25	100
MQBS12	M12	M12(Ø20)	584,617	10	60



MQ-B NEW

Mosquetón bombero



CÓDIGO	MÉTRICA	Ø CABLE	€/100		
MQB04	M4	M4(Ø6)	64,010	100	2.400
MQB05	M5	M5(Ø8)	66,143	100	1.200
MQB06	M6	M6(Ø9)	81,077	100	600
MQB07	M7	M7(Ø10)	104,550	100	600
MQB08	M8	M8(Ø12)	128,017	50	300
MQB09	M9	M9(Ø15)	178,373	25	150
MQB10	M10	M10(Ø15)	213,363	25	150
MQB11	M11	M11(Ø18)	320,047	10	120
MQB12	M12	M12(Ø20)	392,590	10	60
MQB14	M14	M14(Ø25)	883,327	10	40
MQB15	M15	M15(Ø26)	1.237,507	10	30

CM

Accesorios para cercado

CM-BP

Brida poste



METAL



CÓDIGO	MEDIDA	€/100	
CMBRPOS33	33-35	182,317	250
CMBRPOS40	40-43	199,837	200
CMBRPOS42	42-45	203,030	200
CMBRPOS48	48-52	214,265	200
CMBRPOS50	50-53	225,661	200
CMBRPOS60	60-62	236,955	150

CM-BT

Brida tensor



METAL



CÓDIGO	MEDIDA	€/100	
CMBRTEN48	48	364,215	200

CM-TA

Tapón



METAL



CÓDIGO	MEDIDA	€/100	
CMTAPON33	33	84,433	500
CMTAPON40	40	92,693	350
CMTAPON42	42	96,247	350
CMTAPON48	48	106,940	300
CMTAPON50	50	119,257	250
CMTAPON60	60	143,891	250

CM-TP

Tapón poste



METAL



CÓDIGO	MEDIDA	€/100	
CMTAPOS33	33	228,137	100
CMTAPOS40	40	239,403	200
CMTAPOS42	42	240,103	200
CMTAPOS48	48	264,593	150

CM-UN

Uña



METAL



CÓDIGO	MEDIDA	€/100	
CMUNAAGUJ	Con agujero	26,373	1.500

Tensores para cercado

CM-T

METAL



CM-TENSO

Tensor de alambre

CÓDIGO	MEDIDA	€/100	
CMTENSOAL	85 x 29,5	123,967	250



METAL



CM-TENSOVE

Tensor de alambre verde

CÓDIGO	MEDIDA	€/100	
CMTENSOVE	85 x 29,5	183,771	250



METAL



CM-TT

Tensor de tornillo

CÓDIGO	MEDIDA	€/100	
CMTENSOTO	Tornillo	119,120	450





FIJACIONES Y ACCESORIOS PARA PLACAS DE YESO





PL

Tornillo para placa de yeso de altas prestaciones. Fosfatado. Cabeza trompeta, rosca doble hilo y punta alfiler. Huella PH

PL-F

Tornillo

HUECOS



GRATIS - 1 punta en cada caja

CÓDIGO	MEDIDA	€/100		CAPACIDAD DE TALADRADO	UD. MIN. VENTA		
PL35019	3,5 x 19	2,320	PH2	< 0.6 mm	2.000	1.000	12.000
PL35025	3,5 x 25	2,099	PH2	< 0.6 mm	2.000	1.000	12.000
PL35035	3,5 x 35	2,700	PH2	< 0.6 mm	2.000	1.000	6.000
PL35045	3,5 x 45	3,308	PH2	< 0.6 mm	1.000	500	6.000
PL35055	3,5 x 55	4,240	PH2	< 0.6 mm	1.000	500	3.000
PL39025	3,9 x 25	2,603	PH2	< 0.6 mm	2.000	1.000	12.000
PL39035	3,9 x 35	3,660	PH2	< 0.6 mm	2.000	1.000	6.000
PL39045	3,9 x 45	4,613	PH2	< 0.6 mm	1.000	500	3.000
PL39055	3,9 x 55	5,520	PH2	< 0.6 mm	1.000	500	3.000
PL42070	4,2 x 70	8,237	PH2	< 0.6 mm	500	500	3.000
PL42080	4,2 x 80	10,947	PH2	< 0.6 mm	500	500	2.000
PL48090	4,8 x 90	18,400	PH2	< 0.6 mm	500	500	1.500
PL48100	4,8 x 100	22,920	PH2	< 0.6 mm	500	500	1.000
PL48110	4,8 x 110	25,350	PH2	< 0.6 mm	500	500	1.000
PL48120	4,8 x 120	28,073	PH2	< 0.6 mm	500	500	1.000
PL48130	4,8 x 130	30,840	PH2	< 0.6 mm	500	500	1.000

Blíster

CÓDIGO	MEDIDA	€/BOLSA	PCS BOLSA	BOLSAS
BZPL35025	3,5 x 25	2,459	50	10
BZPL35035	3,5 x 35	2,459	40	10
BZPL35045	3,5 x 45	2,459	25	10

Caja ventana

CÓDIGO	MEDIDA	€/CAJA	PCS CAJA	CAJAS
VPL35025	3,5 x 25	6,552	250	8
VPL35035	3,5 x 35	8,286	250	8
VPL35045	3,5 x 45	6,258	150	8

PL-EP

Bote de plástico

HUECOS



CÓDIGO	MEDIDA	€/PC		CAPACIDAD DE TALADRADO	UD. MIN. VENTA		PCS. X BOTE
PLEP35025	3,5 x 25	84,060	PH2	< 0.6 mm	1	1	4.000
PLEP35035	3,5 x 35	80,840	PH2	< 0.6 mm	1	1	3.000

Tornillos para placa de yeso. Cabeza ancha

PL-CA

HUECOS



CÓDIGO	MEDIDA	€/100			
PLCAZ4213	4,2 x 13	3,610	PH2	1.000	12.000
PLCAZ4216	4,2 x 16	3,923	PH2	1.000	12.000
PLCAZ4219	4,2 x 19	4,220	PH2	1.000	12.000
PLCAZ4225	4,2 x 25	4,810	PH2	1.000	6.000
PLCAZ4232	4,2 x 32	5,960	PH2	500	6.000
PLCAZ4241	4,2 x 41	6,763	PH2	500	3.000
PLCAZ4251	4,2 x 51	7,660	PH2	200	2.400



Tornillo para placa de yeso de paso ancho. Cabeza trompeta y punta perforante

PL-RA

HUECOS



CÓDIGO	MEDIDA	€/100		UD. MIN. VENTA		
PLRA3925	3,9 x 25	3,283	PH2	2.000	1.000	12.000
PLRA3935	3,9 x 35	4,167	PH2	2.000	1.000	6.000
PLRA3945	3,9 x 45	5,273	PH2	1.000	500	3.000
PLRA3955	3,9 x 55	5,737	PH2	1.000	500	3.000
PLRA4835	4,8 x 35	5,170	PH2	2.000	1.000	6.000



Tornillo para placas de yeso laminado. Cabeza trompeta y punta autotaladrante

PL-TR

HUECOS



CÓDIGO	MEDIDA	€/100		CAPACIDAD DE TALADRADO	UD. MIN. VENTA		
PLTR3525	3,5 x 25	2,900	PH2	0,6 - 3 mm	2.000	1.000	12.000
PLTR3535	3,5 x 35	3,683	PH2	0,6 - 3 mm	2.000	1.000	6.000
PLTR3545	3,5 x 45	4,443	PH2	0,6 - 3 mm	1.000	500	6.000





CP

Cintas para placas de yeso laminado

CP-PA

Cinta papel para juntas



HUECOS



Cartón yeso

CÓDIGO	MEDIDA	€/PC	
CPPA023	23 m x 50 mm	5,057	20
CPPA075	75 m x 50 mm	9,717	20
CPPA150	150 m x 50 mm	14,490	10



CP-GV

Cinta guardavivros



HUECOS



Cartón yeso

CÓDIGO	MEDIDA	€/PC		
CPGV012	12,5 m	25,420	1	20
CPGV030	30 m	30,697	1	10



CP-AC

Cinta acústica adhesiva



HUECOS



Cartón yeso

CÓDIGO	MEDIDA	€/PC	
CPAC300453	30m x 45 x 3	17,170	26
CPAC300703	30m x 70 x 3	25,943	17

CP-MV

Cinta malla de vidrio



HUECOS



Cartón yeso

CÓDIGO	MEDIDA	€/PC	
CPMV020	20 m	4,130	100
CPMV045	45 m	7,773	64
CPMV090	90 m	15,813	36
CPMV150	150 m	21,963	16



Anclaje universal

OME

MULTIMATERIAL



CÓDIGO	MEDIDA	€/100		
OMEM06	M6	49,737	100	1.000



Media abrazadera M6

MAB

METAL



CÓDIGO	MEDIDA	€/100		
MABM6018	18 (M6)	14,163	100	2.400



Horquilla de cuelgue

HO

HUECOS



CÓDIGO	MEDIDA	€/100		
HOCUM647	M6 (TC47)	29,543	100	1.000

HO-CU

Por giro



HUECOS



CÓDIGO	MEDIDA	€/100		
HOCRM647	M6 (TC47)	43,030	100	1.000
HOCRM660	M6 (TC60)	57,790	100	-

HO-CR

Recta





EMP

Empalme de perfiles



HUECOS



CÓDIGO	MEDIDA	€/100		
EMPTC45	TC 45	41,037	50	150
EMPTC47	TC 47	38,713	50	500
EMPTC60	TC 60	55,713	50	500





CAB

Caballete para cruce de perfiles



HUECOS



CÓDIGO	MEDIDA	€/100		
CABTC47	TC 47	55,327	50	400
CABTC60	TC 60	77,157	50	-





ADU

Anclaje directo "U" para soporte de perfiles en falsos techos



HUECOS



CÓDIGO	MEDIDA	€/100		
ADUTC47	TC 47	68,103	100	400
ADUTC60	TC 60	70,163	100	400



PCU

Pletina de cuelgue



METAL



CÓDIGO	MEDIDA	€/100	UD. MIN. VENTA		
PCU0005	5	21,397	200	100	800
PCU0006	6	21,455	200	100	800



Accesorio para suspensión

SUS

HUECOS

Perfiles de aluminio



CÓDIGO	MEDIDA	€/100		
SUSTC47090	90 (TC47)	24,130	100	1.000
SUSTC47180	180 (TC47)	44,273	100	500
SUSTC47240	240 (TC47)	102,147	100	300
SUSTC47300	300 (TC47)	124,487	50	300
SUSTC47400	400 (TC47)	185,140	50	200



Trampillas de registro para placa de yeso laminado

TR

HUECOS

Cartón yeso



CÓDIGO	MEDIDA	€/PC	
TRBL200200	200 x 200	23,718	1
TRBL300300	300 x 300	34,730	1
TRBL400400	400 x 400	48,900	1
TRBL500500	500 x 500	68,947	1
TRBL600600	600 x 600	88,163	1

TR-BL

Lacada blanca (RAL 9016)



HUECOS

Cartón yeso



CÓDIGO	MEDIDA	€/PC	
TR13200200	200 x 200	37,203	2
TR13300300	300 x 300	45,387	2
TR13400400	400 x 400	56,479	2
TR13500500	500 x 500	70,832	1
TR13600600	600 x 600	88,320	1

TR-13

13 mm



HUECOS

Cartón yeso



CÓDIGO	MEDIDA	€/PC	
TR15200200	200 x 200	73,802	2
TR15300300	300 x 300	82,238	2
TR15400400	400 x 400	98,744	2
TR15500500	500 x 500	119,223	1
TR15600600	600 x 600	139,092	1

TR-15

15 mm





FIJACIÓN DIRECTA



FP-GUN

Pistola semiautomática para fijación a pólvora

FP08GUN

Para clavos de 8 mm



POLVORA



CÓDIGO	MEDIDA	€/PC	
FP08GUN	8mm	799,537	1

FP12GUN

Para clavos de 12 mm



POLVORA



CÓDIGO	MEDIDA	€/PC	
FP12GUN	12mm	1.437,960	1

**PISTOLAS
SUMINISTRADAS
CON MALETÍN
COMPLETO**

CONTENIDO MALETÍN

- Pistola
- Cepillo
- Manual de instrucciones
- Gafas protectoras
- Repuestos
- Aceite lubricante

FP-IM

Impulsores para pistolas de pólvora

FP-IP

Impulsores de pólvora

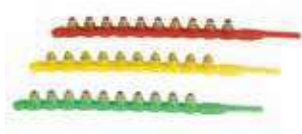

POLVORA

CÓDIGO	POTENCIA	COLOR	€/100	
FPP3VE	POWER 3	VERDE	39,753	100
FPP4AM	POWER 4	AMARILLO	39,753	100
FPP5RO	POWER 5	ROJO	39,753	100

FP-CR

Impulsores de pólvora en disco



POLVORA



CÓDIGO	POTENCIA	COLOR	€/100	
FPCRAM	POWER 4	AMARILLO	49,243	100
FPCRRO	POWER 5	ROJO	49,243	100

Clavos para pistola FP08 a pólvora

FP-CL08

POLVORA



CÓDIGO	MEDIDA	€/100		
FP080816	3,8 x 16	24,804	100	4.500
FP080819	3,8 x 19	27,528	100	4.500



FP-CG 08

Grafilados con arandela de goma



POLVORA



CÓDIGO	MEDIDA	€/100		
FPCL0816	3,8 x 16	11,940	100	4.500
FPCL0819	3,8 x 19	12,367	100	4.500
FPCL0825	3,8 x 25	12,450	100	4.500
FPCL0827	3,8 x 27	12,697	100	2.400
FPCL0832	3,8 x 32	13,320	100	2.400
FPCL0838	3,8 x 38	14,860	100	2.400
FPCL0844	3,8 x 44	15,900	100	2.400
FPCL0851	3,8 x 51	18,040	100	2.400
FPCL0857	3,8 x 57	18,633	100	2.400
FPCL0864	3,8 x 64	20,703	100	1.200
FPCL0870	3,8 x 70	21,563	100	1.200



FP-CL 08

Estándar con arandela de goma



POLVORA



CÓDIGO	MEDIDA	€/100		
FPAP085166	3,8 x 51	116,190	100	200

FP-AP 08

Estándar con arandela de plástico de 66 mm



POLVORA



CÓDIGO	MEDIDA	€/100	
FP303708	3,8 x 37	53,438	100
FP304708	3,8 x 47	55,329	100



FP-C30

Estándar con arandela de plástico de 35 mm



POLVORA



CÓDIGO	MEDIDA	€/100		
FPAM0837	3,8 x 37	32,753	100	600
FPAM0851	3,8 x 51	35,749	100	600

FP-AM 08

Estándar con arandela metálica de 36 mm



FP-CL08 Clavos para pistola FP08 a pólvora

FP-CR 08 M6

Estándar con rosca M6 x 8 para instalación de abrazaderas



POLVORA

CÓDIGO	MEDIDA	€/100		
FPCR0812	3,8 x 12	29,400	100	2.400
FPCR0822	3,8 x 22	30,253	100	2.400
FPCR0827	3,8 x 27	30,723	100	2.400

FP-CR 08 M8

Estándar con rosca M8 x 8 para instalación de abrazaderas



POLVORA

CÓDIGO	MEDIDA	€/100		
FPCRM80812	3,8 x 12	39,950	100	2.400
FPCRM80827	3,8 x 27	42,697	100	2.400

FP-PI 08

Clip abrazadera 13 mm con clavo y goma roja



POLVORA

CÓDIGO	MEDIDA	€/100		
FPPI081613	3,8 x 13	64,673	100	600

FP-CL12 Clavos para pistola FP12 a pólvora

FP-CG 12

Grafilados con arandela metálica de 12 mm



POLVORA

CÓDIGO	MEDIDA	€/100		
FPCG1612	3,8 x 16	15,590	100	4.500
FPCG1912	3,8 x 19	16,020	100	-

FP-CGD12

Grafilados con arandela doble metálica y plástica



POLVORA

CÓDIGO	MEDIDA	€/100		
FPCGD1612	3,8 x 16	19,610	100	100
FPCGD1912	3,8 x 19	20,140	100	100

FP-CL12

Estándar con arandela metálica de 12 mm





POLVORA

CÓDIGO	MEDIDA	€/100		
FPCL2212	3,8 x 22	15,977	100	-
FPCL2712	3,8 x 27	16,800	100	1.000
FPCL3212	3,8 x 32	17,723	100	1.000
FPCL3712	3,8 x 37	18,750	100	-
FPCL4212	3,8 x 42	20,264	100	-
FPCL4712	3,8 x 47	23,110	100	2.400

Clavos para pistola FP12 a pólvora

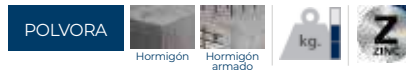
FP-CL12



CÓDIGO	MEDIDA	€/100	
FPCLD2212	3,8 x 22	19,183	100
FPCLD2712	3,8 x 27	20,170	100
FPCLD3212	3,8 x 32	21,317	100
FPCLD3712	3,8 x 37	22,547	100
FPCLD4212	3,8 x 42	23,867	100
FPCLD4712	3,8 x 47	25,953	100

FP-CLD12

Estándar con arandela doble metálica y plástica de 12 mm



CÓDIGO	MEDIDA	€/100	
FPCT3212	3,8 x 32	43,237	100

FP-CT12

Para instalación de falsos techos



Recambios para pistolas FP08GUN y FP12GUN

FP-PIS

POLVORA

CÓDIGO	MEDIDA	€/PC	
FPPIISCL08	8	56,363	1

Válido para clavos con cabeza cóncava. Ref: FP-AP y FP-C30

FP-PISCL08

Pistón para pistola FP08GUN. Válido para clavos con cabeza cóncava



POLVORA

CÓDIGO	MEDIDA	€/PC	
FPPIISPL08	8	56,087	1

Válido para clavos con cabeza plana. Ref: FP-CG, FP-CL, FP-AM, FP-CR, FP-PI.

FP-PISPL08

Pistón plano para pistola FP08GUN. Válido para clavos con cabeza plana



POLVORA

CÓDIGO	MEDIDA	€/PC	
FPPIISCL12	12	86,627	1

Válido para clavos con cabeza cóncava. Ref: FP-CG12, FP-CGD12, FP-CL12, FP-CLD12.

FP-PISCL12

Pistón para pistola FP12GUN. Válido para clavos con cabeza cóncava



POLVORA

CÓDIGO	MEDIDA	€/PC	
FPPIISCM12	M6 x 8	94,927	1

Válido para clavos de Ø12, M6

FP-PISCM12

Pistón para pistola FP12GUN. Válido para clavos de Ø12, M6



POLVORA

CÓDIGO	MEDIDA	€/PC	
FPPIISCT12	12	97,453	1

Válido para clavo FPCT3212

FP-PISCT12

Pistón para pistola FP12GUN. Válido para clavo FPCT3212



FG-GUN

Pistola semiautomática de fijación a gas sin cables

GAS

FG-GUN

Pistola semiautomática de fijación a gas sin cables para tabiquería seca

CÓDIGO	MEDIDA	€/PC	
FG60GUN	Pistola gas / Gas gun / Pistolet gaz	2.160,000	1



CONTENIDO MALETÍN

- Pistola de fijación a gas
- Cargador
- 2 baterías
- Llave Allen
- Manual de instrucciones

PISTOLA SUMINISTRADA CON MALETÍN COMPLETO

- Técnica de anclaje directo para fijaciones ligeras: organizar cableados, colocar perfiles metálicos para la instalación de tabiques de placas de yeso, etc.
- Fijación de metal o madera a hormigón o bloque.
- Pistola suministrada con completo maletín, incluyendo cargador de batería.
- Baterías de larga duración.
- Capacidad para clavos de hasta 40 mm. de longitud.
- Carga de gas suministrada con los consumibles.

FG-GUNEL

Pistola semiautomática de fijación a gas sin cables para electricistas

GAS

CÓDIGO	MEDIDA	€/PC	
FG60GUNEL	Pistola gas / Gas gun / Pistolet gaz	2.479,000	1





CONTENIDO MALETÍN

- Pistola de fijación a gas
- Cargador
- 2 baterías
- Llave Allen
- Manual de instrucciones
- Cañón para electricistas

Clavos para pistola de fijación a gas

FG-CL





CÓDIGO	MEDIDA	€/100		
FGCL15	2,6 x 15	12,277	1.000	
FGCL20	2,6 x 20	12,657	1.000	
FGCL25	2,6 x 25	12,863	1.000	
FGCL30	2,6 x 30	12,987	1.000	
FGCL35	2,6 x 35	14,163	1.000	
FGCL40	2,6 x 40	15,227	1.000	

FG-CL

Clavos estándar



CÓDIGO	MEDIDA	€/100		
FGCLH15	3,1 x 15	13,980	1.000	-
FGCLH17	3,1 x 17	14,257	1.000	5.000
FGCLH19	3,1 x 19	14,257	1.000	-
FGCLH22	3,1 x 22	14,257	1.000	-
FGCLH27	3,1 x 27	14,917	1.000	-
FGCLH32	3,1 x 32	15,440	1.000	-

FG-CLH



Clavos para materiales duros



Accesorios para instalar con pistola de gas

FG-AC





CÓDIGO	MEDIDA	€/100		
OMEM06	M6	49,737	100	1.000

OME

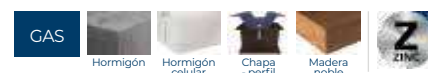
Anclaje universal



CÓDIGO	MEDIDA	€/100		
FGARAM25	Ø25	19,217	200	4.800

FG-ARAM

Arandela metálica

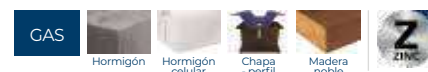

CÓDIGO	MEDIDA	€/PC		PCS. X BOTE
FGARAM25EP	Ø25	180,637	1	1.000

FG-ARAM EP

Arandela metálica. Bote de plástico



FG-AC

Accesorios para instalar con pistola de gas

FG-PLET

Pletina roscada para varilla



CÓDIGO	MEDIDA	€/100		
FGPLET	M6 - M8	167,752	100	400

AB-PID

Grapa 1 pie para disparo



CÓDIGO	MEDIDA	€/100		
ABPID016	16	12,877	100	1.200
ABPID020	20	19,920	100	1.200
ABPID025	25	23,343	100	600
ABPID032	32	28,977	100	600

FG-ABRA

Abrazadera a presión

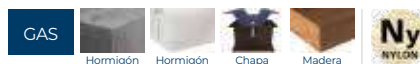

CÓDIGO	MEDIDA	€/100		
FGABRA15	15 - 18	59,577	100	-
FGABRA20	20 - 25	62,960	50	200
FGABRA25	25 - 32	75,703	50	-

INSTALACIÓN

PISTOLA



FG-BASE

Base para brida



CÓDIGO	COLOR	€/100		
FGBASENE	NEGRO	16,173	100	1.200
FGBASEGR	GRIS	16,660	100	1.200

Accesorios para pistola de gas

FG-APG



CÓDIGO	MEDIDA	€/PC	
FGCAEL	11	200,000	1

FG-CAEL

Cañón de pistola especial para electricistas



CÓDIGO	MEDIDA	€/PC	
FGCLCAR40	40	305,927	1

FG-CLCAR

Cargador para 40 clavos



CÓDIGO	MEDIDA	€/PC	
FGIMAN	Øinterior 11,25	151,107	1

FG-IMAN

Imán



CÓDIGO	€/PC	
FG60BAT	380,653	1

FG-BAT

Batería para pistola FP60GUN



CÓDIGO	€/PC	
FG60CAR	299,025	1

FG-CAR

Cargador para pistola FP60GUN



CÓDIGO	MEDIDA	€/PC		
FG60GAS	80 ml.	32,570	1	12

FG-GAS

Cartucho de gas





TORNILLOS PARA CUBIERTAS Y FACHADAS





DIN-7504-K

Tornillo autotaladrante de cabeza hexagonal

DIN-7504-K

Tornillo



Disponible en diferentes colores



Disponible en varios recubrimientos. Consulte precio y plazo de entrega.



CÓDIGO	MEDIDA	€/100				CÓDIGO	MEDIDA	€/100			
ABE3509	3,5 x 9,5	2,406	6	1.000	24.000	ABE5563	5,5 x 63	14,846	8	250	1.000
ABE3513	3,5 x 13	2,485	6	1.000	12.000	ABE5575	5,5 x 75	18,183	8	250	1.500
ABE3516	3,5 x 16	2,829	6	1.000	12.000	ABE6319	6,3 x 19	10,377	10	500	3.000
ABE3519	3,5 x 19	3,008	6	1.000	12.000	ABE6325	6,3 x 25	10,998	10	500	3.000
ABE4213	4,2 x 13	3,468	7	1.000	12.000	ABE6332	6,3 x 32	12,759	10	500	2.000
ABE4216	4,2 x 16	3,696	7	1.000	8.000	ABE6338	6,3 x 38	14,326	10	500	2.000
ABE4219	4,2 x 19	4,164	7	1.000	8.000	ABE6350	6,3 x 50	17,572	10	250	1.500
ABE4225	4,2 x 25	4,950	7	500	6.000	ABE6363	6,3 x 63	20,773	10	250	1.500
ABE4232	4,2 x 32	5,627	7	500	6.000	ABE6375	6,3 x 75	24,305	10	250	1.000
ABE4238	4,2 x 38	6,473	7	500	6.000	ABE6380	6,3 x 80	27,034	10	250	1.000
ABE4813	4,8 x 13	4,494	8	1.000	8.000	ABE6390	6,3 x 90	31,835	10	250	750
ABE4816	4,8 x 16	4,578	8	1.000	6.000	ABE6310	6,3 x 100	34,207	10	100	600
ABE4819	4,8 x 19	5,092	8	500	6.000	ABE6311	6,3 x 110	41,401	10	100	600
ABE4825	4,8 x 25	5,747	8	500	6.000	ABE6312	6,3 x 120	48,820	10	100	600
ABE4832	4,8 x 32	7,116	8	500	3.000	ABE6313	6,3 x 130	54,755	10	100	600
ABE4838	4,8 x 38	7,899	8	500	3.000	ABE6314	6,3 x 140	64,008	10	100	600
ABE5519	5,5 x 19	6,718	8	500	6.000	ABE6315	6,3 x 150	76,366	10	100	600
ABE5522	5,5 x 22	6,990	8	500	4.000	ABE6316	6,3 x 160	84,775	10	100	400
ABE5525	5,5 x 25	7,420	8	500	4.000	ABE6318	6,3 x 180	109,701	10	100	300
ABE5532	5,5 x 32	8,833	8	500	3.000	ABE6320	6,3 x 200	140,008	10	100	300
ABE5538	5,5 x 38	10,027	8	500	3.000	ABE6322	6,3 x 220	177,303	10	100	200
ABE5550	5,5 x 50	12,123	8	500	2.000	ABE6324	6,3 x 240	200,236	10	100	200

Blíster

CÓDIGO	MEDIDA	€/BOLSA	PCS	BOLSAS
BZABE3509	3,5 x 9,5	2,459	20	20
BZABE3513	3,5 x 13	2,459	20	20
BZABE4213	4,2 x 13	2,459	20	20
BZABE4216	4,2 x 16	2,459	20	20
BZABE4219	4,2 x 19	2,459	20	20
BZABE4225	4,2 x 25	2,459	10	20
BZABE4813	4,8 x 13	2,459	20	20
BZABE4816	4,8 x 16	2,459	20	20
BZABE4819	4,8 x 19	2,459	10	20
BZABE4825	4,8 x 25	2,459	10	20
BZABE4832	4,8 x 32	2,459	10	20
BZABE4838	4,8 x 38	2,459	10	20
BZABE5519	5,5 x 19	2,459	10	20
BZABE5522	5,5 x 22	2,459	10	20
BZABE5525	5,5 x 25	2,459	10	20
BZABE5532	5,5 x 32	2,459	10	20
BZABE5538	5,5 x 38	2,459	10	20
BZABE5550	5,5 x 50	2,459	10	20
BZABE6325	6,3 x 25	2,459	10	20
BZABE6332	6,3 x 32	2,459	10	20
BZABE6338	6,3 x 38	2,459	10	20
BZABE6350	6,3 x 50	2,459	5	20

Caja ventana

CÓDIGO	MEDIDA	€/CAJA	PCS	CAJAS
VABE3509	3,5 x 9,5	5,976	225	8
VABE3513	3,5 x 13	6,185	200	8
VABE4213	4,2 x 13	6,164	150	8
VABE4216	4,2 x 16	6,745	150	8
VABE4219	4,2 x 19	7,729	150	8
VABE4225	4,2 x 25	4,629	75	8
VABE4232	4,2 x 32	5,637	75	8
VABE4813	4,8 x 13	8,276	150	8
VABE4816	4,8 x 16	8,881	150	8
VABE4819	4,8 x 19	9,680	150	8
VABE4825	4,8 x 25	10,920	150	8
VABE4832	4,8 x 32	9,069	110	8
VABE4838	4,8 x 38	8,009	85	8
VABE5519	5,5 x 19	10,222	125	8
VABE5522	5,5 x 22	10,744	125	8
VABE5525	5,5 x 25	11,851	125	8
VABE5532	5,5 x 32	9,337	85	8
VABE5538	5,5 x 38	9,781	80	8
VABE5550	5,5 x 50	8,862	60	8
VABE5563	5,5 x 63	7,118	40	8
VABE6319	6,3 x 19	12,279	100	8
VABE6325	6,3 x 25	12,279	90	8
VABE6332	6,3 x 32	11,294	70	8
VABE6338	6,3 x 38	10,473	60	8
VABE6350	6,3 x 50	8,507	40	8
VABE6363	6,3 x 63	6,508	25	8

DIN-7504-K A2

Tornillo. Inoxidable A2



CÓDIGO	MEDIDA	€/100			
ABEI4213	4,2 x 13	16,923	7	1.000	12.000
ABEI4216	4,2 x 16	18,987	7	1.000	8.000
ABEI4219	4,2 x 19	19,680	7	1.000	8.000
ABEI4813	4,8 x 13	23,940	8	1.000	8.000
ABEI4816	4,8 x 16	23,393	8	500	6.000
ABEI4819	4,8 x 19	25,313	8	500	6.000
ABEI4825	4,8 x 25	28,347	8	500	6.000
ABEI4832	4,8 x 32	33,703	8	500	3.000
ABEI5519	5,5 x 19	34,947	8	500	6.000
ABEI5522	5,5 x 22	37,283	8	500	4.000
ABEI5525	5,5 x 25	39,623	8	500	6.000
ABEI6319	6,3 x 19	52,967	10	500	3.000
ABEI6325	6,3 x 25	60,260	10	500	3.000



Tornillo autotaladrante de cabeza hexagonal

DIN-7504-K



DIN-7504-K + ARVUL

Tornillo con arandela vulcanizada de acero-EPDM

CÓDIGO	MEDIDA	€/100			
ABE144219	4,2 x 19 P14	9,028	7	1.000	4.000
ABE144225	4,2 x 25 P14	12,783	7	500	3.000
ABE144816	4,8 x 16 P14	8,949	8	1.000	4.000
ABE144819	4,8 x 19 P14	8,298	8	1.000	4.000
ABE144825	4,8 x 25 P14	10,295	8	1.000	4.000
ABE144832	4,8 x 32 P14	14,870	8	500	3.000
ABE144838	4,8 x 38 P14	16,358	8	500	3.000
ABE145522	5,5 x 22 P14	12,380	8	1.000	4.000
ABE145532	5,5 x 32 P14	15,674	8	1.000	3.000
ABE164219	4,2 x 19 P16	11,972	7	1.000	4.000
ABE164816	4,8 x 16 P16	9,770	8	1.000	4.000
ABE164819	4,8 x 19 P16	9,396	8	1.000	3.000
ABE164825	4,8 x 25 P16	10,209	8	1.000	3.000
ABE164832	4,8 x 32 P16	13,138	8	500	3.000
ABE164838	4,8 x 38 P16	13,478	8	500	2.000
ABE165519	5,5 x 19 P16	11,245	8	1.000	3.000
ABE165522	5,5 x 22 P16	11,347	8	1.000	3.000
ABE165525	5,5 x 25 P16	12,279	8	1.000	3.000
ABE165532	5,5 x 32 P16	13,030	8	1.000	2.000
ABE165538	5,5 x 38 P16	14,898	8	1.000	2.000
ABE165550	5,5 x 50 P16	16,891	8	500	1.500
ABE165563	5,5 x 63 P16	21,111	8	250	1.500
ABE165575	5,5 x 75 P16	24,733	8	250	1.000
ABE166319	6,3 x 19 P16	15,962	10	500	3.000
ABE166325	6,3 x 25 P16	15,082	10	500	2.000
ABE166332	6,3 x 32 P16	18,297	10	500	2.000
ABE166338	6,3 x 38 P16	19,509	10	500	2.000
ABE166350	6,3 x 50 P16	22,470	10	500	1.000
ABE166363	6,3 x 63 P16	27,993	10	250	1.000
ABE166375	6,3 x 75 P16	30,912	10	250	750
ABE166380	6,3 x 80 P16	36,791	10	100	600
ABE166390	6,3 x 90 P16	42,903	10	100	600
ABE166310	6,3 x 100 P16	44,786	10	100	600
ABE166311	6,3 x 110 P16	51,137	10	100	600
ABE166312	6,3 x 120 P16	58,822	10	100	400
ABE166313	6,3 x 130 P16	64,743	10	100	400
ABE166314	6,3 x 140 P16	71,834	10	100	400

CÓDIGO	MEDIDA	€/100			
ABE184819	4,8 x 19 P18	14,649	8	500	3.000
ABE184825	4,8 x 25 P18	15,545	8	500	3.000
ABE184838	4,8 x 38 P18	17,882	8	500	2.000
ABE185522	5,5 x 22 P18	15,355	8	500	3.000
ABE185525	5,5 x 25 P18	16,756	8	500	3.000
ABE185532	5,5 x 32 P18	17,735	8	500	2.000
ABE185538	5,5 x 38 P18	18,934	8	500	2.000
ABE185550	5,5 x 50 P18	22,181	8	500	1.500
ABE185563	5,5 x 63 P18	23,509	8	250	1.000
ABE186319	6,3 x 19 P18	17,336	10	500	3.000
ABE186325	6,3 x 25 P18	17,578	10	500	2.000
ABE186332	6,3 x 32 P18	20,893	10	500	2.000
ABE186338	6,3 x 38 P18	22,365	10	250	1.500
ABE186350	6,3 x 50 P18	24,926	10	250	1.000
ABE186363	6,3 x 63 P18	29,060	10	250	1.000
ABE186375	6,3 x 75 P18	32,329	10	250	750
ABE186380	6,3 x 80 P18	38,014	10	100	600
ABE186390	6,3 x 90 P18	38,711	10	100	600
ABE186310	6,3 x 100 P18	44,893	10	100	400
ABE186311	6,3 x 110 P18	52,716	10	100	400
ABE186312	6,3 x 120 P18	60,919	10	100	400
ABE186313	6,3 x 130 P18	73,560	10	100	400
ABE186314	6,3 x 140 P18	76,940	10	100	400
ABE255522	5,5 x 22 P25	19,424	8	500	1.500
ABE255525	5,5 x 25 P25	21,822	8	500	1.500
ABE256325	6,3 x 25 P25	24,024	10	500	1.500
ABE256332	6,3 x 32 P25	26,490	10	500	1.000
ABE256338	6,3 x 38 P25	28,845	10	250	750
ABE256350	6,3 x 50 P25	33,083	10	250	750
ABE256363	6,3 x 63 P25	33,589	10	100	600
ABE256380	6,3 x 80 P25	43,504	10	100	300
ABE256390	6,3 x 90 P25	46,337	10	100	400
ABE256310	6,3 x 100 P25	49,974	10	100	400
ABE256311	6,3 x 110 P25	54,504	10	100	300
ABE256312	6,3 x 120 P25	63,087	10	100	300
ABE256313	6,3 x 130 P25	69,135	10	100	300
ABE256314	6,3 x 140 P25	75,596	10	100	200



Disponible en diferentes colores

Disponible en varios recubrimientos. Consulte precio y plazo de entrega.



Blíster

CÓDIGO	MEDIDA	€/BOLSA	PCS	BOLSAS
BZABE144819	4,8 x 19 P14	2,459	18	10
BZABE144825	4,8 x 25 P14	2,459	18	10
BZABE164819	4,8 x 19 P16	2,459	18	10
BZABE165522	5,5 x 22 P16	2,459	15	10
BZABE165525	5,5 x 25 P16	2,459	15	10
BZABE165532	5,5 x 32 P16	2,459	12	10
BZABE165538	5,5 x 38 P16	2,459	12	10
BZABE165550	5,5 x 50 P16	2,459	10	10
BZABE166325	6,3 x 25 P16	2,459	10	10
BZABE166332	6,3 x 32 P16	2,459	8	10
BZABE166338	6,3 x 38 P16	2,459	8	10

Caja ventana

CÓDIGO	MEDIDA	€/CAJA	PCS	CAJAS
VABE144819	4,8 x 19 P14	11,041	100	8
VABE144825	4,8 x 25 P14	9,787	80	8
VABE164819	4,8 x 19 P16	8,066	70	8
VABE165522	5,5 x 22 P16	9,072	70	8
VABE165525	5,5 x 25 P16	9,236	60	8
VABE165532	5,5 x 32 P16	7,979	50	8
VABE165538	5,5 x 38 P16	8,126	45	8
VABE165550	5,5 x 50 P16	7,149	35	8
VABE166325	6,3 x 25 P16	8,852	50	8
VABE166332	6,3 x 32 P16	11,298	50	8
VABE166338	6,3 x 38 P16	9,628	40	8



DIN-7504-K CP + ARVUL

Bote de plástico

CÓDIGO	MEDIDA	€/UD			PCS. X BOTE
ABE144819CP	4,8 x 19 P14	112,835	8	1	1.250
ABE164819CP	4,8 x 19 P16	121,544	8	1	1.250
ABE165522CP	5,5 x 22 P16	146,608	8	1	1.250
ABE166325CP	6,3 x 25 P16	117,943	10	1	750



DIN-7504-K RE Tornillo autotaladrante de punta reducida y cabeza hexagonal de 8 mm

DIN-7504-K RE

Tornillo



Disponible en diferentes colores



Disponible en varios recubrimientos. Consulte precio y plazo de entrega.



CÓDIGO	MEDIDA	€/100			
ARE4816	4,8 x 16	5,673	8	500	6.000
ARE4819	4,8 x 19	5,957	8	500	6.000
ARE5522	5,5 x 22	8,560	8	500	4.000
ARE6320	6,3 x 20	9,377	8	500	3.000
ARE6325	6,3 x 25	11,143	8	500	3.000
ARE6332	6,3 x 32	13,563	8	500	3.000
ARE6338	6,3 x 38	15,613	8	500	3.000
ARE6350	6,3 x 50	19,030	8	250	1.500
ARE6363	6,3 x 63	24,623	8	250	1.500
ARE6380	6,3 x 80	30,613	8	250	1.000

DIN-7504-K RE + ARVUL

Tornillo con arandela vulcanizada de acero-EPDM



Disponible en diferentes colores



Disponible en varios recubrimientos. Consulte precio y plazo de entrega.



CÓDIGO	MEDIDA	€/100			
ARE164816	4,8 x 16 P16	14,803	8	500	3.000
ARE164819	4,8 x 19 P16	15,483	8	500	3.000
ARE165522	5,5 x 22 P16	15,573	8	500	3.000
ARE166320	6,3 x 20 P16	16,077	8	500	3.000
ARE166325	6,3 x 25 P16	17,560	8	500	3.000
ARE166332	6,3 x 32 P16	23,877	8	500	2.000
ARE166338	6,3 x 38 P16	24,774	8	500	2.000
ARE166350	6,3 x 50 P16	29,328	8	250	1.500

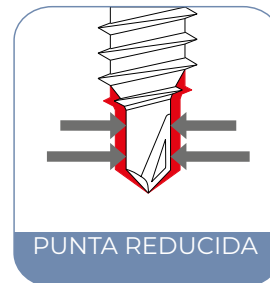

NEW DIN-7504-K RE NI + ARVUL

Tornillo autotaladrante punta reducida Atlantis C4-M + Arandela vulcanizada EPDM-inoxidable A2



CÓDIGO	MEDIDA	€/100			
AREN166325	6,25 x 25 P-16	32,300	8	500	3.000





Tornillo para viga autotaladrante con cabeza hexagonal

AUTO



CÓDIGO	MEDIDA	€/100		ESPESOR MÁX. A FIJAR	CAPACIDAD DE TALADRADO		
AUTO532	5,5 x 32	15,162	8	21,5	4,00-12,00	500	3.000
AUTO538	5,5 x 38	16,573	8	27,5	4,00-12,00	500	3.000
AUTO550	NEW 5,5 x 50	20,352	8	39,5	4,00-12,00	500	2.000
AUTO510	NEW 5,5 x 100	39,195	8	80	4,00-12,00	100	600
AUTO580	NEW 5,5 x 80	30,633	8	67	4,00-12,00	250	1.000
AUTO560	NEW 5,5 x 60	23,391	8	49,5	4,00-12,00	250	1.500

AUTO

Tornillo



Disponible en varios recubrimientos. Consulte precio y plazo de entrega.



CÓDIGO	MEDIDA	€/100		ESPESOR MÁX. A FIJAR	CAPACIDAD DE TALADRADO		
AUTO16532	5,5 x 32 P16	19,257	8	19,5	4,00-12,00	500	2.000
AUTO16538	5,5 x 38 P16	20,507	8	25,5	4,00-12,00	500	2.000
AUTO16510	NEW 5,5 x 100 P16	46,035	8	78	4,00-12,00	100	600
AUTO16550	NEW 5,5 x 50 P16	25,980	8	37,5	4,00-12,00	500	2.000
AUTO16560	NEW 5,5 x 60 P16	28,350	8	47,5	4,00-12,00	250	1.000
AUTO16580	NEW 5,5 x 80 P16	35,640	8	65	4,00-12,00	250	1.000

AUTO + ARVUL

Tornillo con arandela vulcanizada de acero-EPDM



Disponible en varios recubrimientos. Consulte precio y plazo de entrega.

Tornillo autotaladrante inoxidable bimetetal con cabeza hexagonal ABE BIMETAL



CÓDIGO	MEDIDA	€/100		ESPESOR MÁX. A FIJAR	CAPACIDAD DE TALADRADO		
BIE4825	4,8 x 25	69,316	8	9	1,75-4,40	500	6.000
BIE5525	5,5 x 25	81,254	8	5	1,75-5,25	500	6.000
BIE5532	5,5 x 32	93,313	8	12	1,75-5,25	500	3.000
BIE5538	5,5 x 38	99,214	8	18	1,75-5,25	500	3.000
BIE5550	5,5 x 50	114,514	8	30	1,75-5,25	500	2.000
BIE5558	5,5 x 58	127,455	8	38	1,75-5,25	250	1.500
BIE5565	5,5 x 65	133,217	8	45	1,75-5,25	250	1.500
BIE5580	5,5 x 80	157,168	8	60	1,75-5,25	250	1.000
BIE6325	6,3 x 25	104,045	10	7	2,50-6,00	500	3.000

ABE BIMETAL

Tornillo



CÓDIGO	MEDIDA	€/100		ESPESOR MÁX. A FIJAR	CAPACIDAD DE TALADRADO		
BIE164825	4,8 x 25 P16	83,140	8	7	1,75-4,40	500	2.000
BIE165525	5,5 x 25 P16	96,319	8	3	1,75-5,25	500	2.000
BIE165532	5,5 x 32 P16	109,581	8	10	1,75-5,25	500	2.000
BIE165538	5,5 x 38 P16	115,253	8	16	1,75-5,25	500	1.500
BIE165550	5,5 x 50 P16	134,429	8	28	1,75-5,25	500	1.500
BIE165558	5,5 x 58 P16	144,635	8	36	1,75-5,25	250	1.500
BIE165565	5,5 x 65 P16	150,525	8	43	1,75-5,25	250	1.500
BIE165580	5,5 x 80 P16	175,166	8	58	1,75-5,25	250	1.000
BIE166325	6,3 x 25 P16	120,333	10	5	2,50-6,00	500	2.000

ABE BIMETAL + ARVUL

Tornillo con arandela vulcanizada de acero-EPDM



AUTO BIMETAL

Tornillo viga autotaladrante inoxidable bimetetal con cabeza hexagonal

AUTO BIMETAL

Tornillo



CÓDIGO	MEDIDA	€/100		ESPESOR MÁX. A FIJAR	CAPACIDAD DE TALADRADO		
BAUTO5540	5,5 x 40	121,031	8	10	4,00-12,00	500	3.000
BAUTO5550	5,5 x 50	168,200	8	20	4,00-12,00	500	3.000
BAUTO5565	5,5 x 65	175,713	8	35	4,00-12,00	250	1.500
BAUTO5580	5,5 x 80	220,863	8	50	4,00-12,00	250	1.000
BAUTO5510	5,5 x 100	223,343	8	70	4,00-12,00	100	600

AUTO BIMETAL + ARVUL

Tornillo con arandela vulcanizada de acero-EPDM



CÓDIGO	MEDIDA	€/100		ESPESOR MÁX. A FIJAR	CAPACIDAD DE TALADRADO		
BAUTO165540	5,5 x 40 P16	143,457	8	8	4,00-12,00	500	1.500
BAUTO165550	5,5 x 50 P16	193,930	8	18	4,00-12,00	500	1.500
BAUTO165565	5,5 x 65 P16	200,373	8	33	4,00-12,00	250	1.500
BAUTO165580	5,5 x 80 P16	235,510	8	48	4,00-12,00	250	1.000
BAUTO165510	5,5 x 100 P16	248,297	8	68	4,00-12,00	100	600

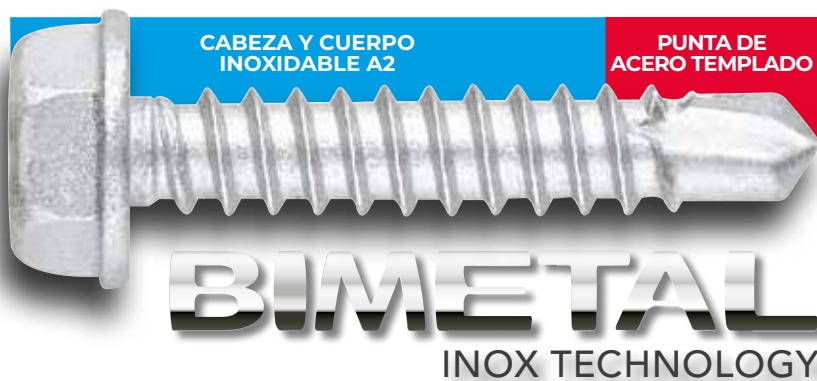

Los beneficios del tornillo broca de acero con la durabilidad anticorrosión de un inoxidable

RECUBRIMIENTO ATLANTIS C3-H

AUE

Tornillo rosca chapa con cabeza hexagonal

AUE

Tornillo



CÓDIGO	MEDIDA	€/100				
AUE6319	6,3 x 19	8,660	10		500	3.000
AUE6325	6,3 x 25	10,037	10		500	3.000
AUE6332	6,3 x 32	11,123	10		500	2.000
AUE6340	6,3 x 40	13,280	10		500	2.000
AUE6350	6,3 x 50	15,280	10		500	1.500
AUE6360	6,3 x 60	17,977	10		250	1.000
AUE6380	6,3 x 80	23,583	10		250	1.000
AUE6310	6,3 x 100	30,097	10		250	750
AUE6311	6,3 x 110	36,393	10		250	750
AUE6312	6,3 x 120	39,670	10		250	750
AUE6313	6,3 x 130	48,773	10		250	750
AUE6314	6,3 x 140	54,750	10		250	500
AUE6315	6,3 x 150	67,293	10		100	400

Disponible en diferentes colores

Disponible en varios recubrimientos. Consulte precio y plazo de entrega.



Tornillo rosca chapa con cabeza hexagonal

AUE



CÓDIGO	MEDIDA	€/100			
AUE166319	6,3 x 19 P16	15,617	10	500	2.000
AUE166325	6,3 x 25 P16	16,540	10	500	2.000
AUE166332	6,3 x 32 P16	18,543	10	500	2.000
AUE166340	6,3 x 40 P16	20,387	10	500	1.500
AUE166350	6,3 x 50 P16	23,453	10	500	1.500
AUE166360	6,3 x 60 P16	27,723	10	250	1.000
AUE166380	6,3 x 80 P16	35,373	10	250	750
AUE186325	6,3 x 25 P18	18,600	10	500	2.000
AUE186332	6,3 x 32 P18	20,813	10	500	1.500
AUE186340	6,3 x 40 P18	24,573	10	500	1.500
AUE186350	6,3 x 50 P18	25,560	10	500	1.500
AUE186360	6,3 x 60 P18	29,973	10	250	1.000
AUE186380	6,3 x 80 P18	38,853	10	250	750
AUE186310	6,3 x 100 P18	45,367	10	250	750
AUE186311	6,3 x 110 P18	51,413	10	250	500
AUE186312	6,3 x 120 P18	59,133	10	100	400
AUE186313	6,3 x 130 P18	69,123	10	100	400
AUE186314	6,3 x 140 P18	75,027	10	100	400
AUE186315	6,3 x 150 P18	76,847	10	100	400
AUE256325	6,3 x 25 P25	28,397	10	500	1.500

AUE + ARVUL

Tornillo con arandela vulcanizada de acero-EPDM



Disponible en diferentes colores

Disponible en varios recubrimientos. Consulte precio y plazo de entrega.



CÓDIGO	MEDIDA	€/100		
AUENI166325	6,25 x 25 P-16	38,000	500	2.000

AUE NI + ARVUL **NEW**

Tornillo autorroscante Atlantis C4-M + Arandela vulcanizada EPDM-inoxidable A2



Tornillo autotaladrante de cabeza hexagonal para panel sándwich

PS



CÓDIGO	MEDIDA	€/100		ESPESOR MÁX. A FIJAR	CAPACIDAD DE TALADRADO		
PS55060	5,5 / 6,3 x 60	19,230	8	31 - 45	1,50-6,00	500	1.500
PS55082	5,5 / 6,3 x 82	24,860	8	43 - 67	1,50-6,00	500	1.000
PS55098	5,5 / 6,3 x 98	30,550	8	54 - 83	1,50-6,00	500	1.000
PS55115	5,5 / 6,3 x 115	35,820	8	56 - 100	1,50-6,00	500	1.000
PS55130	5,5 / 6,3 x 130	61,330	8	66 - 115	1,50-6,00	200	400
PS55150	5,5 / 6,3 x 150	78,733	8	86 - 135	1,50-6,00	200	400
PS55180	5,5 / 6,3 x 180	118,930	8	116 - 165	1,50-6,00	200	400

PS 3

Punta broca estándar #3. Zincado



CÓDIGO	MEDIDA	€/100		ESPESOR MÁX. A FIJAR	CAPACIDAD DE TALADRADO		
PS1655060	5,5 / 6,3 x 60 P16	23,580	8	31 - 45	1,50-6,00	500	1.000
PS1655082	5,5 / 6,3 x 82 P16	29,543	8	43 - 67	1,50-6,00	500	1.000
PS1655098	5,5 / 6,3 x 98 P16	34,810	8	54 - 83	1,50-6,00	500	1.000
PS1655115	5,5 / 6,3 x 115 P16	40,927	8	56 - 100	1,50-6,00	500	-
PS1655130	5,5 / 6,3 x 130 P16	52,761	8	66 - 115	1,50-6,00	200	-
PS1655150	5,5 / 6,3 x 150 P16	60,610	8	86 - 135	1,50-6,00	200	400
PS1655180	5,5 / 6,3 x 180 P16	99,088	8	116 - 165	1,50-6,00	200	400

PS 3 + ARVUL

Punta broca estándar #3 con arandela vulcanizada de acero-EPDM. Zincado



PS

Tornillo autotaladrante de cabeza hexagonal para panel sándwich

PS 3 + ARVUL A2

Punta broca estándar #3 con recubrimiento ATLANTIS C4-M y arandela inoxidable A2



CÓDIGO	MEDIDA	€/100		ESPESOR MÁX. A FIJAR	CAPACIDAD DE TALADRADO		
PS1955195	5,5 / 6,3 x 195 P19	271,965	8	130 - 185	1,50-6,00	200	400
PS1955230	5,5 / 6,3 x 230 P19	362,090	8	166 - 215	1,50-6,00	200	-

PS 5

Punta broca extra larga #5. Zincado



CÓDIGO	MEDIDA	€/100		ESPESOR MÁX. A FIJAR	CAPACIDAD DE TALADRADO		
PSL55075	5,5 / 6,3 x 75	25,387	8	33 - 60	6,00-12,00	500	1.500
PSL55085	5,5 / 6,3 x 85	27,940	8	38 - 70	6,00-12,00	500	1.000
PSL55105	5,5 / 6,3 x 105	38,003	8	48 - 90	6,00-12,00	500	1.000
PSL55130	5,5 / 6,3 x 130	53,203	8	63 - 115	6,00-12,00	250	750
PSL55150	5,5 / 6,3 x 150	63,190	8	83 - 135	6,00-12,00	250	750
PSL55175	5,5 / 6,3 x 175	124,303	8	108 - 160	6,00-12,00	200	400
PSL55200	5,5 / 6,3 x 200	148,417	8	133 - 185	6,00-12,00	200	400
PSL55230	5,5 / 6,3 x 230	222,447	8	163 - 215	6,00-12,00	200	400

PS 5 + ARVUL

Punta broca extra larga #5 con arandela vulcanizada de acero-EPDM. Zincado





CÓDIGO	MEDIDA	€/100		ESPESOR MÁX. A FIJAR	CAPACIDAD DE TALADRADO		
PSL1655075	5,5 / 6,3 x 75 P16	31,300	8	33 - 60	6,00-12,00	500	1.000
PSL1655085	5,5 / 6,3 x 85 P16	37,190	8	38 - 70	6,00-12,00	500	1.000
PSL1655105	5,5 / 6,3 x 105 P16	44,753	8	48 - 90	6,00-12,00	500	-
PSL1655130	5,5 / 6,3 x 130 P16	62,163	8	63 - 115	6,00-12,00	250	500
PSL1655150	5,5 / 6,3 x 150 P16	73,667	8	83 - 135	6,00-12,00	250	500
PSL1655175	5,5 / 6,3 x 175 P16	114,093	8	-	6,00-12,00	200	400
PSL1655200	5,5 / 6,3 x 200 P16	125,104	8	-	6,00-12,00	200	400
PSL1655230	5,5 / 6,3 x 230 P16	194,073	8	-	6,00-12,00	200	400

PS 5 + ARVUL A2

Punta broca extra larga #5 con recubrimiento ATLANTIS C4-M y arandela inoxidable A2



CÓDIGO	MEDIDA	€/100		ESPESOR MÁX. A FIJAR	CAPACIDAD DE TALADRADO	
PSL1955255	5,5 / 6,3 x 255 P19	504,267	8	170 - 210	6,00-12,00	200
PSL1955285	5,5 / 6,3 x 285 P19	829,807	8	200 - 250	6,00-12,00	200

FIBR

Tornillo autotaladrante para fibrocemento, montado con arandela paraguas



CÓDIGO	MEDIDA	€/100		ESPESOR MÁX. A FIJAR	CAPACIDAD DE TALADRADO	
FI63110	6,3 x 110	102,797	8	75	6,00-12,00	250
FI63115	6,3 x 115	95,840	8	85	1,00-6,00	250
FI63120	6,3 x 120	100,240	8	85	6,00-12,00	250
FI63125	6,3 x 125	95,793	8	95	1,00-6,00	250
FI63130	6,3 x 130	111,787	8	95	6,00-12,00	250
FI63150	6,3 x 150	106,690	8	115	6,00-12,00	250
FI63160	6,3 x 160	132,213	8	125	6,00-12,00	250



Arandela vulcanizada de acero-EPDM

ARVUL

METAL



CÓDIGO	MEDIDA	€/100	Ø INTERIOR ARANDELA		
ARANE14	P14	4,155	2.5	1.000	12.000
ARANE16	P16	4,750	2.7	1.000	6.000
ARANE18	P18	6,247	3.2	1.000	6.000
ARANE25	P25	11,157	3.3	500	3.000

ARVUL

Recubrimiento ATLANTIS C2-M



Blíster

CÓDIGO	MEDIDA	€/BOLSA	PCS B	BOLSAS
BZARANE14	P14	1,943	20	10
BZARANE16	P16	1,943	20	10
BZARANE18	P18	1,943	20	10

Caja ventana

CÓDIGO	MEDIDA	€/CAJA	PCS	CAJAS
VARANE14	P14	5,078	100	8
VARANE16	P16	5,634	100	8
VARANE18	P18	7,391	100	8
VARANE25	P25	12,801	100	8

INOXIDABLE



CÓDIGO	MEDIDA	€/100	Ø INTERIOR ARANDELA		
ARINO14	P14	11,587	2.5	1.000	12.000
ARINO16	P16	13,100	2.7	1.000	6.000
ARINO18	P18	16,485	3.2	1.000	6.000
ARINO25	P25	30,483	3.3	500	3.000
ARINOM30	P30	48,630	6.3	500	1.500

ARVUL A2

Inoxidable A2



* ARINOM30: Especial instalaciones con anclaje MTH-A2, Ø6.

Arandela paraguas

ARPAR

METAL



CÓDIGO	MEDIDA	€/100		
ARPAR25	P22	30,753	250	1.500

ARPAR ^{NEW}

Galvanizada



METAL



CÓDIGO	MEDIDA	€/100		
ARPARA225	P22	41,150	250	1.500

ARPAR A2 ^{NEW}

Inoxidable A2





ATAP

Tapón de nylon de colores para tornillos con cabeza hexagonal



METAL



CÓDIGO	COLOR	€/100			
ATAPO08AR	RAL 1001	7,557	8	1.000	2.000
ATAPO08RC	RAL 3003	7,557	8	1.000	2.000
ATAPO08RT	RAL 3011	7,557	8	1.000	2.000
ATAPO08VN	RAL 6028	7,557	8	1.000	2.000
ATAPO08BP	RAL 9010	7,557	8	1.000	2.000
ATAPO08NE	RAL 9005	7,557	8	1.000	2.000
ATAPO08BO	RAL 9002	7,557	8	1.000	2.000
ATAPO10AR	RAL 3011	7,557	10	1.000	2.000
ATAPO10RC	RAL 3003	7,557	10	1.000	2.000
ATAPO10RT	RAL 3011	7,557	10	1.000	2.000
ATAPO10VN	RAL 6028	7,557	10	1.000	2.000
ATAPO10BP	RAL 9010	7,557	10	1.000	2.000
ATAPO10NE	RAL 9005	7,557	10	1.000	2.000
ATAPO10BO	RAL 9002	7,557	10	1.000	2.000
ATAPO08BS NEW	RAL 9003	7,557	8	1.000	2.000
ATAPO08GM NEW	RAL 9006	7,557	8	1.000	2.000
ATAPO08RX NEW	RAL 3009	7,557	8	1.000	2.000
ATAPO08PC NEW	RAL 8004	7,557	8	1.000	2.000
ATAPO10BS NEW	RAL 9003	7,557	10	1.000	2.000
ATAPO10GM NEW	RAL 9006	7,557	10	1.000	2.000
ATAPO10RX NEW	RAL 3009	7,557	10	1.000	2.000
ATAPO10PC NEW	RAL 8004	7,557	10	1.000	2.000

NEW



TDR

Tornillo autorroscante de reparación



METAL



CÓDIGO	MEDIDA	€/100		
TDR2572032	7,2 x 32	48,363	500	1.000
TDR2572025	7,2 x 25	42,923	500	1.000
TDR2572038	7,2 x 38	52,577	250	750



TORNILLOS BROCA, ROSCA CHAPA Y PVC



DIN-7504-N

Tornillo autotaladrante de cabeza alomada

DIN-7504-N HP Z

Zincado. Huella PH



Disponible en varios recubrimientos. Consulte precio y plazo de entrega.

CÓDIGO	MEDIDA	€/100	ES	ESPEJOR MÁX. A FIJAR	CAPACIDAD DE TALADRADO			CÓDIGO	MEDIDA	€/100	ES	ESPEJOR MÁX. A FIJAR	CAPACIDAD DE TALADRADO		
ABR3509	3,5 x 9,5	1,703	PH2	2,8	0,70-2,25	1.000	24.000	ABR4813	4,8 x 13	3,816	PH2	3,7	1,75-4,40	1.000	8.000
ABR3511	3,5 x 11	1,977	PH2	4,2	0,70-2,25	1.000	24.000	ABR4816	4,8 x 16	3,913	PH2	5,5	1,75-4,40	1.000	8.000
ABR3513	3,5 x 13	2,030	PH2	6,2	0,70-2,25	1.000	24.000	ABR4819	4,8 x 19	4,313	PH2	10,3	1,75-4,40	1.000	8.000
ABR3516	3,5 x 16	2,203	PH2	9,2	0,70-2,25	1.000	16.000	ABR4822	4,8 x 22	5,010	PH2	11,7	1,75-4,40	500	6.000
ABR3519	3,5 x 19	2,473	PH2	12,1	0,70-2,25	1.000	12.000	ABR4825	4,8 x 25	5,203	PH2	14,7	1,75-4,40	500	6.000
ABR3522	3,5 x 22	2,710	PH2	15,1	0,70-2,25	1.000	12.000	ABR4832	4,8 x 32	5,950	PH2	21,5	1,75-4,40	500	6.000
ABR3525	3,5 x 25	2,803	PH2	18,1	0,70-2,25	500	12.000	ABR4838	4,8 x 38	7,140	PH2	27,5	1,75-4,40	500	3.000
ABR3532	3,5 x 32	3,583	PH2	25,1	0,70-2,25	500	6.000	ABR4845	4,8 x 45	7,990	PH2	34,5	1,75-4,40	500	3.000
ABR3913	3,9 x 13	2,430	PH2	5,8	0,70-2,40	1.000	16.000	ABR4850	4,8 x 50	8,987	PH2	39,5	1,75-4,40	500	3.000
ABR3916	3,9 x 16	2,657	PH2	8,8	0,70-2,40	1.000	12.000	ABR4860	4,8 x 60	11,460	PH2	49,5	1,75-4,40	500	2.000
ABR3919	3,9 x 19	2,953	PH2	11,7	0,70-2,40	1.000	12.000	ABR4875	4,8 x 75	14,010	-	64,5	1,75-4,40	250	1.500
ABR3925	3,9 x 25	3,510	PH2	17,7	0,70-2,40	500	8.000	ABR4880	4,8 x 80	14,967	PH2	69,5	1,75-4,40	250	1.500
ABR3932	3,9 x 32	4,307	PH2	24,5	0,70-2,40	500	6.000	ABR4890	4,8 x 90	21,330	PH2	79,5	1,75-4,40	100	1.200
ABR4213	4,2 x 13	2,683	PH2	4,3	1,75-3,00	1.000	12.000	ABR4810	4,8 x 100	24,067	PH2	89,5	1,75-4,40	100	1.200
ABR4216	4,2 x 16	2,937	PH2	7,3	1,75-3,00	1.000	12.000	ABR5519	5,5 x 19	5,960	PH3	8,7	1,75-5,25	500	6.000
ABR4219	4,2 x 19	3,257	PH2	10,3	1,75-3,00	1.000	12.000	ABR5522	5,5 x 22	6,840	PH3	11,7	1,75-5,25	500	6.000
ABR4222	4,2 x 22	3,703	PH2	13,3	1,75-3,00	500	8.000	ABR5525	5,5 x 25	7,110	PH3	14,7	1,75-5,25	500	4.000
ABR4225	4,2 x 25	3,929	PH2	17,7	1,75-3,00	500	6.000	ABR5532	5,5 x 32	8,336	PH3	21,5	1,75-5,25	500	3.000
ABR4232	4,2 x 32	4,700	PH2	24,5	1,75-3,00	500	6.000	ABR5538	5,5 x 38	9,273	PH3	27,5	1,75-5,25	500	3.000
ABR4238	4,2 x 38	5,300	PH2	30,5	1,75-3,00	500	6.000	ABR5545	5,5 x 45	10,623	PH3	34,5	1,75-5,25	500	3.000
ABR4250	4,2 x 50	6,640	PH2	41	1,75-3,00	500	3.000	ABR5560	5,5 x 60	14,247	PH3	49,5	1,75-5,25	250	1.500
ABR4811	4,8 x 110	24,893	PH2	-	1,75-4,40	100	1.200	ABR5573	5,5 x 73	15,663	PH3	62,5	1,75-5,25	250	1.500
ABR4812	4,8 x 120	28,427	PH2	-	1,75-4,40	100	1.200								

Blíster

CÓDIGO	MEDIDA	€/BOLSA	PCS	BOLSAS
BZABR3509	3,5 x 9,5	2,459	40	15
BZABR3513	3,5 x 13	2,459	40	15
BZABR3516	3,5 x 16	2,459	40	15
BZABR4213	4,2 x 13	2,459	40	15
BZABR4216	4,2 x 16	2,459	40	15
BZABR4219	4,2 x 19	2,459	40	15
BZABR4225	4,2 x 25	2,459	20	15
BZABR4232	4,2 x 32	2,459	20	15
BZABR4816	4,8 x 16	2,459	35	15
BZABR4819	4,8 x 19	2,459	35	15
BZABR4825	4,8 x 25	2,459	20	15
BZABR4832	4,8 x 32	2,459	20	15
BZABR4838	4,8 x 38	2,459	20	15
BZABR4845	4,8 x 45	2,459	20	15
BZABR4850	4,8 x 50	2,459	20	15
BZABR4860	4,8 x 60	2,459	20	15

Caja ventana

CÓDIGO	MEDIDA	€/CAJA	PCS	CAJAS
VABR3509	3,5 x 9,5	5,592	275	8
VABR3511	3,5 x 11	5,698	250	8
VABR3513	3,5 x 13	6,007	250	8
VABR3516	3,5 x 16	5,836	225	8
VABR3519	3,5 x 19	6,174	225	8
VABR3525	3,5 x 25	5,974	180	8
VABR3913	3,9 x 13	7,130	250	8
VABR3916	3,9 x 16	6,292	200	8
VABR3919	3,9 x 19	6,745	200	8
VABR3925	3,9 x 25	6,286	150	8
VABR3932	3,9 x 32	10,093	200	8
VABR4213	4,2 x 13	6,304	200	8
VABR4216	4,2 x 16	6,703	200	8
VABR4219	4,2 x 19	6,650	175	8
VABR4222	4,2 x 22	7,374	175	8
VABR4225	4,2 x 25	5,603	125	8

Caja ventana

CÓDIGO	MEDIDA	€/CAJA	PCS	CAJAS
VABR4232	4,2 x 32	4,904	90	8
VABR4238	4,2 x 38	4,795	75	8
VABR4250	4,2 x 50	4,503	50	8
VABR4813	4,8 x 13	5,895	125	8
VABR4816	4,8 x 16	5,856	125	8
VABR4819	4,8 x 19	5,657	110	8
VABR4822	4,8 x 22	5,445	90	8
VABR4825	4,8 x 25	5,554	90	8
VABR4832	4,8 x 32	5,392	75	8
VABR4838	4,8 x 38	4,785	55	8
VABR4845	4,8 x 45	4,865	50	8
VABR4850	4,8 x 50	4,463	40	8
VABR4860	4,8 x 60	5,795	40	8
VABR4880	4,8 x 80	5,054	25	8
VABR5532	5,5 x 32	4,886	50	8

DIN-7504-N HP A2

Inoxidable A2. Huella PH

INOXIDABLE



CÓDIGO	MEDIDA	€/100	ES	ESPEJOR MÁX. A FIJAR	CAPACIDAD DE TALADRADO		
ABRA23509	3,5 x 9,5	11,517	PH2	2,85	0,70-2,25	1.000	24.000
ABRA23513	3,5 x 13	13,643	PH2	6,2	0,70-2,25	500	12.000
ABRA23519	3,5 x 19	16,717	PH2	12,1	0,70-2,25	500	12.000
ABRA24213	4,2 x 13	15,980	PH2	4,3	1,75-3,00	500	12.000
ABRA24216	4,2 x 16	17,900	PH2	7,3	1,75-3,00	500	12.000
ABRA24219	4,2 x 19	19,050	PH2	10,3	1,75-3,00	500	12.000
ABRA24225	4,2 x 25	20,750	PH2	16,3	1,75-3,00	250	6.000
ABRA24816	4,8 x 16	25,067	PH2	5,5	1,75-4,40	250	6.000
ABRA24819	4,8 x 19	25,467	PH2	8,7	1,75-4,40	250	6.000
ABRA24825	4,8 x 25	28,293	PH2	14,7	1,75-4,40	250	6.000
ABRA24832	4,8 x 32	33,117	PH2	21,5	1,75-4,40	250	4.000
ABRA24838	4,8 x 38	36,257	PH2	27,5	1,75-4,40	250	3.000
ABRA24850	4,8 x 50	42,750	PH2	39,5	1,75-4,40	250	3.000

Tornillo autotaladrante de cabeza alomada

DIN-7504-N

METAL



CÓDIGO	MEDIDA	€/100		ESPESOR MÁX. A FIJAR	CAPACIDAD DE TALADRADO		
NBR3509	3,5 x 9,5	2,526	PH2	2,85	0,70-2,25	1.000	24.000
NBR3513	3,5 x 13	3,057	PH2	6,2	0,70-2,25	1.000	24.000
NBR3516	3,5 x 16	3,222	PH2	9,2	0,70-2,25	1.000	16.000
NBR3519	3,5 x 19	3,555	PH2	12,1	0,70-2,25	1.000	12.000
NBR4213	4,2 x 13	3,852	PH2	4,3	1,75-3,00	1.000	12.000
NBR4216	4,2 x 16	4,269	PH2	7,3	1,75-3,00	1.000	12.000
NBR4219	4,2 x 19	4,794	PH2	10,3	1,75-3,00	1.000	12.000
NBR4225	4,2 x 25	5,913	PH2	16,3	1,75-3,00	500	6.000
NBR4232	4,2 x 32	7,026	PH2	23	1,75-3,00	500	6.000
NBR4238	4,2 x 38	8,247	PH2	29	1,75-3,00	500	6.000
NBR4816	4,8 x 16	5,886	PH2	5,5	1,75-4,40	1.000	8.000
NBR4819	4,8 x 19	6,846	PH2	8,7	1,75-4,40	1.000	8.000
NBR4825	4,8 x 25	8,058	PH2	14,7	1,75-4,40	500	6.000
NBR4832	4,8 x 32	9,609	PH2	21,5	1,75-4,40	500	6.000
NBR4838	4,8 x 38	10,428	PH2	27,5	1,75-4,40	500	3.000
NBR4845	4,8 x 45	12,093	PH2	34,5	1,75-4,40	500	3.000
NBR4850	4,8 x 50	13,113	PH2	39,5	1,75-4,40	500	3.000

DIN-7504-N HP N



Zincado negro. Huella PH



Otras medidas, consultar precio y plazo

METAL



CÓDIGO	MEDIDA	€/100		ESPESOR MÁX. A FIJAR	CAPACIDAD DE TALADRADO		
ABR3509BLE	3,5 x 9,5	1,833	PH2	2,85	0,70-2,25	1.000	24.000
ABR3513BLE	3,5 x 13	4,379	PH2	6,2	0,70-2,25	1.000	24.000
ABR3516BLE	3,5 x 16	4,928	PH2	9,2	0,70-2,25	1.000	16.000
ABR4213BLE	4,2 x 13	5,726	PH2	4,3	1,75-3,00	1.000	12.000
ABR4216BLE	4,2 x 16	6,362	PH2	7,3	1,75-3,00	1.000	12.000
ABR4219BLE	4,2 x 19	6,386	PH2	10,3	1,75-3,00	1.000	12.000
ABR4825BLE	4,8 x 25	9,161	PH2	14,7	1,75-4,40	500	6.000

DIN-7504-N HP B

Pintado blanco. Huella PH



Otras medidas, consultar precio y plazo

DIN-7504-N Tornillo autotaladrante de cabeza alomada

DIN-7504-N HT

Zincado. Huella TX/OXBIT



GRATIS - 1 punta en cada caja



CÓDIGO	MEDIDA	€/100		ESPESOR MÁX. A FIJAR	CAPACIDAD DE TALADRADO		
ABRT3509	3,5 x 9,5	1,877	Tx20/OXBIT20	2,8	0,70-2,25	1.000	24.000
ABRT3513	3,5 x 13	2,280	Tx20/OXBIT20	6,2	0,70-2,25	1.000	24.000
ABRT3516	3,5 x 16	2,477	Tx20/OXBIT20	9,2	0,70-2,25	1.000	16.000
ABRT3519	3,5 x 19	2,720	Tx20/OXBIT20	12,1	0,70-2,25	1.000	12.000
ABRT3913	3,9 x 13	2,730	Tx20/OXBIT20	5,8	0,70-2,40	1.000	16.000
ABRT3916	3,9 x 16	2,990	Tx20/OXBIT20	8,8	0,70-2,40	1.000	12.000
ABRT3919	3,9 x 19	3,323	Tx20/OXBIT20	11,7	0,70-2,40	1.000	12.000
ABRT3925	3,9 x 25	3,947	Tx20/OXBIT20	17,7	0,70-2,40	500	8.000
ABRT4213	4,2 x 13	2,957	Tx20/OXBIT20	4,3	1,75-3,00	1.000	12.000
ABRT4216	4,2 x 16	3,237	Tx20/OXBIT20	7,3	1,75-3,00	1.000	12.000
ABRT4219	4,2 x 19	3,667	Tx20/OXBIT20	10,3	1,75-3,00	1.000	12.000
ABRT4225	4,2 x 25	4,333	Tx20/OXBIT20	17,7	1,75-3,00	500	6.000
ABRT4232	4,2 x 32	5,073	Tx20/OXBIT20	24,5	1,75-3,00	500	6.000
ABRT4238	4,2 x 38	5,957	Tx20/OXBIT20	30,5	1,75-3,00	500	6.000
ABRT4250	4,2 x 50	7,467	Tx20/OXBIT20	41	1,75-3,00	500	3.000
ABRT4813	4,8 x 13	4,117	Tx25/OXBIT25	3,7	1,75-4,40	1.000	8.000
ABRT4816	4,8 x 16	4,400	Tx25/OXBIT25	5,5	1,75-4,40	1.000	8.000
ABRT4819	4,8 x 19	4,857	Tx25/OXBIT25	10,3	1,75-4,40	1.000	8.000
ABRT4825	4,8 x 25	5,853	Tx25/OXBIT25	14,7	1,75-4,40	500	6.000
ABRT4832	4,8 x 32	6,693	Tx25/OXBIT25	21,5	1,75-4,40	500	6.000
ABRT4838	4,8 x 38	7,870	Tx25/OXBIT25	27,5	1,75-4,40	500	3.000
ABRT4845	4,8 x 45	8,987	Tx25/OXBIT25	34,5	1,75-4,40	500	3.000
ABRT4850	4,8 x 50	10,107	Tx25/OXBIT25	39,5	1,75-4,40	500	3.000
ABRT4860	4,8 x 60	12,890	Tx25/OXBIT25	49,5	1,75-4,40	500	2.000
ABRT4875	4,8 x 75	15,060	-	64,5	1,75-4,40	250	1.500
ABRT4880	4,8 x 80	16,837	Tx25/OXBIT25	69,5	1,75-4,40	250	1.500
ABRT4890	4,8 x 90	23,993	Tx25/OXBIT25	79,5	1,75-4,40	100	1.200
ABRT4810	4,8 x 100	27,077	Tx25/OXBIT25	89,5	1,75-4,40	100	1.200
ABRT4811	4,8 x 110	28,007	Tx25/OXBIT25	-	1,75-4,40	100	1.200
ABRT4812	4,8 x 120	30,970	Tx25/OXBIT25	-	1,75-4,40	100	1.200
ABRT5519	5,5 x 19	6,700	Tx25/OXBIT25	8,7	1,75-5,25	500	6.000
ABRT5525	5,5 x 25	8,000	Tx25/OXBIT25	14,7	1,75-5,25	500	4.000
ABRT5532	5,5 x 32	9,273	Tx25/OXBIT25	21,5	1,75-5,25	500	3.000
ABRT5538	5,5 x 38	10,430	Tx25/OXBIT25	27,5	1,75-5,25	500	3.000
ABRT5560	5,5 x 60	16,367	Tx25/OXBIT25	49,5	1,75-5,25	250	1.500
ABRT5573	5,5 x 73	17,623	Tx25/OXBIT25	62,5	1,75-5,25	250	1.500

DIN-7504-N HC

Zincado. Huella cuadrada



GRATIS - 1 punta en cada caja



CÓDIGO	MEDIDA	€/100		ESPESOR MÁX. A FIJAR	CAPACIDAD DE TALADRADO		
ABRC3509	3,5 x 9,5	1,779	PC1	2,85	0,70-2,25	1.000	24.000
ABRC3513	3,5 x 13	2,079	PC1	6,2	0,70-2,25	1.000	24.000
ABRC3516	3,5 x 16	2,262	PC1	9,2	0,70-2,25	1.000	16.000
ABRC3519	3,5 x 19	2,484	PC1	12,1	0,70-2,25	1.000	12.000
ABRC3913	3,9 x 13	2,490	PC1	5,8	0,70-2,40	1.000	16.000
ABRC3916	3,9 x 16	2,730	PC1	8,8	0,70-2,40	1.000	12.000
ABRC3919	3,9 x 19	3,033	PC1	11,7	0,70-2,40	1.000	12.000
ABRC3925	3,9 x 25	3,600	PC1	17,7	0,70-2,40	500	8.000
ABRC3938	3,9 x 38	4,020	PC1	30,5	0,70-2,40	500	6.000
ABRC4213	4,2 x 13	2,697	PC2	4,3	1,75-3,00	1.000	12.000
ABRC4216	4,2 x 16	2,958	PC2	7,3	1,75-3,00	1.000	12.000
ABRC4219	4,2 x 19	3,348	PC2	10,3	1,75-3,00	1.000	12.000
ABRC4225	4,2 x 25	3,948	PC2	16,3	1,75-3,00	500	6.000
ABRC4232	4,2 x 32	4,626	PC2	23	1,75-3,00	500	6.000
ABRC4238	4,2 x 38	5,439	PC2	29	1,75-3,00	500	6.000
ABRC4816	4,8 x 16	4,017	PC2	5,5	1,75-4,40	1.000	8.000
ABRC4819	4,8 x 19	4,431	PC2	8,7	1,75-4,40	1.000	8.000
ABRC4825	4,8 x 25	5,340	PC2	14,7	1,75-4,40	500	6.000
ABRC4832	4,8 x 32	6,111	PC2	21,5	1,75-4,40	500	6.000
ABRC4838	4,8 x 38	7,182	PC2	27,5	1,75-4,40	500	3.000
ABRC4845	4,8 x 45	8,199	PC2	34,5	1,75-4,40	500	3.000
ABRC4850	4,8 x 50	9,222	PC2	39,5	1,75-4,40	500	3.000
ABRC4860	4,8 x 60	11,763	PC2	49,5	1,75-4,40	500	2.000
ABRC4880	4,8 x 80	15,360	PC2	69,5	1,75-4,40	250	1.500
ABRC4890	4,8 x 90	21,888	PC2	79,5	1,75-4,40	100	1.200
ABRC4810	4,8 x 100	24,699	PC2	89,5	1,75-4,40	100	1.200
ABRC5525	5,5 x 25	7,296	PC3	13	1,75-5,25	500	4.000
ABRC5573	5,5 x 73	16,074	PC3	61	1,75-5,25	250	1.500



Tornillo autotaladrante con cabeza avellanada

DIN-7504-P

METAL



DIN-7504-P HP Z

Zincado. Huella PH

CÓDIGO	MEDIDA	€/100		ESPESOR MÁX. A FIJAR	CAPACIDAD DE TALADRADO		
ABP3509	3,5 x 9,5	2,154	PH2	2,85	0,70-2,25	1.000	24.000
ABP3511	3,5 x 11	1,733	PH2	4,2	0,70-2,25	1.000	24.000
ABP3513	3,5 x 13	1,905	PH2	6,2	0,70-2,25	1.000	24.000
ABP3516	3,5 x 16	2,005	PH2	9,2	0,70-2,25	1.000	24.000
ABP3519	3,5 x 19	2,295	PH2	12,1	0,70-2,25	1.000	12.000
ABP3522	3,5 x 22	2,620	PH2	15,1	0,70-2,25	1.000	12.000
ABP3525	3,5 x 25	2,737	PH2	18,1	0,70-2,25	500	12.000
ABP3913	3,9 x 13	2,053	PH2	5,8	0,70-2,40	1.000	24.000
ABP3916	3,9 x 16	2,347	PH2	8,8	0,70-2,40	1.000	12.000
ABP3919	3,9 x 19	2,663	PH2	11,7	0,70-2,40	1.000	12.000
ABP3922	3,9 x 22	2,987	PH2	14,7	0,70-2,40	500	12.000
ABP3925	3,9 x 25	3,053	PH2	17,7	0,70-2,40	500	12.000
ABP3932	3,9 x 32	3,673	PH2	24,5	0,70-2,40	500	6.000
ABP3938	3,9 x 38	4,380	PH2	30,5	0,70-2,40	500	6.000
ABP4213	4,2 x 13	2,417	PH2	4,3	1,75-3,00	1.000	12.000
ABP4216	4,2 x 16	2,587	PH2	7,3	1,75-3,00	1.000	12.000
ABP4219	4,2 x 19	2,937	PH2	10,3	1,75-3,00	1.000	12.000
ABP4222	4,2 x 22	3,243	PH2	13,3	1,75-3,00	500	12.000
ABP4225	4,2 x 25	3,610	PH2	16,3	1,75-3,00	500	6.000
ABP4232	4,2 x 32	4,237	PH2	23	1,75-3,00	500	6.000
ABP4238	4,2 x 38	4,950	PH2	29	1,75-3,00	500	6.000
ABP4813	4,8 x 13	3,383	PH2	3,7	1,75-4,40	1.000	12.000
ABP4816	4,8 x 16	3,533	PH2	5,5	1,75-4,40	1.000	12.000
ABP4819	4,8 x 19	3,873	PH2	8,7	1,75-4,40	1.000	8.000
ABP4825	4,8 x 25	4,407	PH2	14,7	1,75-4,40	500	6.000
ABP4832	4,8 x 32	5,707	PH2	21,5	1,75-4,40	500	6.000
ABP4838	4,8 x 38	6,473	PH2	27,5	1,75-4,40	500	3.000
ABP4850	4,8 x 50	8,127	PH2	39,5	1,75-4,40	500	3.000
ABP5519	5,5 x 19	5,307	PH3	8,7	1,75-5,25	500	6.000
ABP5525	5,5 x 25	6,063	PH3	14,7	1,75-5,25	500	6.000
ABP5532	5,5 x 32	7,430	PH3	21,5	1,75-5,25	500	3.000
ABP5538	5,5 x 38	8,630	PH3	27,5	1,75-5,25	500	3.000
ABP5550	5,5 x 50	10,897	PH3	39,5	1,75-5,25	500	3.000



Blíster

CÓDIGO	MEDIDA	€/BOLSA	PCS	BOLSAS
BZABP3513	3,5 x 13	2,459	40	20
BZABP3516	3,5 x 16	2,459	40	20
BZABP4219	4,2 x 19	2,459	40	20
BZABP4225	4,2 x 25	2,459	20	20
BZABP4232	4,2 x 32	2,459	20	20

Caja ventana

CÓDIGO	MEDIDA	€/CAJA	PCS	CAJAS
VABP3513	3,5 x 13	5,384	250	8
VABP3516	3,5 x 16	5,354	225	8
VABP3519	3,5 x 19	5,593	200	8
VABP3525	3,5 x 25	5,779	180	8
VABP3913	3,9 x 13	5,162	200	8
VABP3916	3,9 x 16	5,807	200	8
VABP3919	3,9 x 19	5,627	175	8
VABP3925	3,9 x 25	5,413	150	8
VABP3938	3,9 x 38	5,090	100	8
VABP4213	4,2 x 13	5,280	175	8
VABP4216	4,2 x 16	5,415	175	8
VABP4219	4,2 x 19	5,864	175	8
VABP4225	4,2 x 25	5,282	125	8
VABP4232	4,2 x 32	4,631	90	8
VABP4238	4,2 x 38	4,513	75	8
VABP4816	4,8 x 16	5,531	125	8
VABP4819	4,8 x 19	4,863	100	8
VABP4825	4,8 x 25	4,666	90	8
VABP4832	4,8 x 32	4,985	75	8
VABP4838	4,8 x 38	5,811	75	8
VABP5532	5,5 x 32	4,528	50	8

DIN-7504-P Tornillo autotaladrante con cabeza avellanada

DIN-7504-P HP N

Zincado negro. Huella PH



CÓDIGO	MEDIDA	€/100		ESPESOR MÁX. A FIJAR	CAPACIDAD DE TALADRADO		
NBP3513	3,5 x 13	2,775	PH2	6,2	0,70-2,25	1.000	24.000
NBP3516	3,5 x 16	3,030	PH2	9,2	0,70-2,25	1.000	24.000
NBP3519	3,5 x 19	3,426	PH2	12,1	0,70-2,25	1.000	12.000
NBP3525	3,5 x 25	4,335	PH2	18,1	0,70-2,25	500	12.000
NBP4216	4,2 x 16	3,843	PH2	7,3	1,75-3,00	1.000	12.000
NBP4219	4,2 x 19	4,605	PH2	10,3	1,75-3,00	1.000	12.000
NBP4225	4,2 x 25	5,325	PH2	16,3	1,75-3,00	500	6.000
NBP4232	4,2 x 32	6,333	PH2	23	1,75-3,00	500	6.000
NBP4238	4,2 x 38	8,166	PH2	29	1,75-3,00	500	6.000
NBP4825	4,8 x 25	7,386	PH2	14,7	1,75-4,40	500	6.000
NBP4832	4,8 x 32	8,913	PH2	21,5	1,75-4,40	500	6.000
NBP4838	4,8 x 38	10,260	PH2	27,5	1,75-4,40	500	3.000
NBP4850	4,8 x 50	12,435	PH2	39,5	1,75-4,40	500	3.000

DIN-7504-P HT Z

Zincado. Huella TX/OXBIT



CÓDIGO	MEDIDA	€/100		ESPESOR MÁX. A FIJAR	CAPACIDAD DE TALADRADO		
ABPT3513	3,5 x 13	2,167	Tx15/OXBIT15	6,2	0,70-2,25	1.000	24.000
ABPT3516	3,5 x 16	2,280	Tx15/OXBIT15	9,2	0,70-2,25	1.000	24.000
ABPT3519	3,5 x 19	2,640	Tx15/OXBIT15	12,1	0,70-2,25	1.000	12.000
ABPT3913	3,9 x 13	2,310	Tx15/OXBIT15	5,8	0,70-2,40	1.000	24.000
ABPT3916	3,9 x 16	2,640	Tx15/OXBIT15	8,8	0,70-2,40	1.000	12.000
ABPT4213	4,2 x 13	2,717	Tx20/OXBIT20	4,3	1,75-3,00	1.000	12.000
ABPT4216	4,2 x 16	2,910	Tx20/OXBIT20	7,3	1,75-3,00	1.000	12.000
ABPT4219	4,2 x 19	3,307	Tx20/OXBIT20	10,3	1,75-3,00	1.000	12.000
ABPT4225	4,2 x 25	4,063	Tx20/OXBIT20	16,3	1,75-3,00	500	6.000
ABPT4232	4,2 x 32	4,767	Tx20/OXBIT20	23	1,75-3,00	500	6.000
ABPT4819	4,8 x 19	4,357	Tx25/OXBIT25	8,7	1,75-4,40	1.000	8.000
ABPT4825	4,8 x 25	4,957	Tx25/OXBIT25	14,7	1,75-4,40	500	6.000
ABPT4832	4,8 x 32	6,423	Tx25/OXBIT25	21,5	1,75-4,40	500	6.000
ABPT4838	4,8 x 38	7,283	Tx25/OXBIT25	27,5	1,75-4,40	500	3.000
ABPT4850	4,8 x 50	9,143	Tx25/OXBIT25	39,5	1,75-4,40	500	3.000

GRATIS - 1 punta en cada caja

TORNILLERÍA LACADA EN COLORES

AMPLIAR INFORMACIÓN EN PÁGINA 174



SOLO CABEZA



TORNILLO COMPLETO



Tornillo autotaladrante con broca de dos alas, cabeza avellanada

ABA



CÓDIGO	MEDIDA	€/100		ESPESOR MÁX. A FIJAR	CAPACIDAD DE TALADRADO		
ABA4832	4,8 x 32	5,573	PH2	16	1,75 - 4,00	500	6.000
ABA4838	4,8 x 38	6,283	PH2	22	1,75 - 4,00	500	6.000
ABA4845	4,8 x 45	7,437	PH2	29	1,75 - 4,00	500	3.000
ABA4850	4,8 x 50	8,457	PH2	34	1,75 - 4,00	500	3.000
ABA5538	5,5 x 38	9,414	PH2	19	1,75 - 5,00	500	3.000
ABA5545	5,5 x 45	10,053	PH2	26	1,75 - 5,00	500	3.000
ABA5555	5,5 x 55	12,000	PH2	36	1,75 - 5,00	500	3.000
ABA5565	5,5 x 65	13,881	PH2	46	1,75 - 5,00	500	2.000
ABA6360	6,3 x 60	18,126	PH3	40	2,50 - 6,00	250	1.500
ABA6370	6,3 x 70	20,631	PH3	50	2,50 - 6,00	250	1.500
ABA6385	6,3 x 85	25,993	PH3	65	2,50 - 6,00	250	1.000

ABA

Zincado. Huella PH

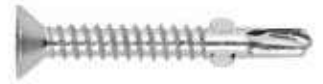

Disponible en varios recubrimientos. Consulte precio y plazo de entrega.

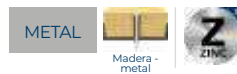

CÓDIGO	MEDIDA	€/100		ESPESOR MÁX. A FIJAR	CAPACIDAD DE TALADRADO		
ATA4832	4,8 x 32	5,847	TX25	16	1,75 - 4,00	500	6.000
ATA4838	4,8 x 38	6,770	TX25	22	1,75 - 4,00	500	6.000
ATA4845	4,8 x 45	7,600	TX25	29	1,75 - 4,00	500	3.000
ATA4850	4,8 x 50	9,107	TX25	34	1,75 - 4,00	500	3.000
ATA5538	5,5 x 38	10,140	TX25	19	1,75 - 5,00	500	3.000
ATA5545	5,5 x 45	10,557	TX25	26	1,75 - 5,00	500	3.000
ATA5550	5,5 x 50	12,033	TX25	31	1,75 - 5,00	500	3.000
ATA5555	5,5 x 55	12,318	TX25	36	1,75 - 5,00	500	2.000
ATA5565	5,5 x 65	15,297	TX25	46	1,75 - 5,00	500	2.000
ATA6350	6,3 x 50	17,583	TX30	30	2,50 - 6,00	500	2.000
ATA6360	6,3 x 60	19,539	TX30	40	2,50 - 6,00	250	1.500
ATA6370	6,3 x 70	22,239	TX30	50	2,50 - 6,00	250	1.500
ATA6385	6,3 x 85	27,283	TX30	65	2,50 - 6,00	250	1.000
ATA6310	6,3 x 100	39,313	TX30	80	2,50 - 6,00	250	750

ATA

Zincado. Huella TX



Disponible en varios recubrimientos. Consulte precio y plazo de entrega.

Tornillo punta broca, cabeza remache y huella PH

RS



CÓDIGO	MEDIDA	€/100		ESPESOR MÁX. A FIJAR	CAPACIDAD DE TALADRADO		
RSZ3509	3,5 x 9	3,303	PH2	2,8	0,75 - 2,25	500	22.500
RSZ3513	3,5 x 13	3,697	PH2	6,2	0,75 - 2,25	500	22.500
RSZ3516	3,5 x 16	4,087	PH2	9,2	0,75 - 2,25	500	22.500
RSZ4213	4,2 x 13	4,637	PH2	4,3	1,75 - 3	500	22.500
RSZ4216	4,2 x 16	4,933	PH2	7,3	1,75 - 3	500	12.000
RSZ4219	4,2 x 19	5,680	PH2	10,3	1,75 - 3	500	12.000
RSZ4225	4,2 x 25	7,227	PH2	16,3	1,75 - 3	250	6.000
RSZ4232	4,2 x 32	7,717	PH2	23	1,75 - 3	250	6.000
RSZ4813	4,8 x 13	6,940	PH2	3,7	1,75 - 4,4	500	12.000
RSZ4816	4,8 x 16	7,303	PH2	5,5	1,75 - 4,4	250	11.250
RSZ4819	4,8 x 19	8,273	PH2	8,7	1,75 - 4,4	250	11.250
RSZ4825	4,8 x 25	10,047	PH2	14,7	1,75 - 4,4	250	6.000
RSZ4832	4,8 x 32	10,483	PH2	21,5	1,75 - 4,4	250	3.000
RSZ4838	4,8 x 38	12,197	PH2	27,5	1,75 - 4,4	250	3.000

RS

Zincado



Disponible en varios recubrimientos. Consulte precio y plazo de entrega.



CÓDIGO	MEDIDA	€/100		ESPESOR MÁX. A FIJAR	CAPACIDAD DE TALADRADO		
RSA23509	3,5 x 9,5	14,270	PH2	2,8	0,75 - 2,25	500	22.500
RSA24213	4,2 x 13	20,557	PH2	7,3	1,75 - 3	500	22.500
RSA24216	4,2 x 16	21,897	PH2	10,3	1,75 - 3	500	12.000
RSA24219	4,2 x 19	23,220	PH2	16,3	1,75 - 3	500	12.000
RSA24816	4,8 x 16	28,733	PH2	5,5	1,75 - 4,4	250	11.250
RSA24819	4,8 x 19	30,790	PH2	8,7	1,75 - 4,4	250	11.250
RSA24825	4,8 x 25	34,737	PH2	14,7	1,75 - 4,4	250	6.000

RS-A2

Inoxidable A2



BCP

Tornillo autotaladrante de cabeza extraplana y huella PH

BCP Z

Zincado. Huella PH



 Disponible en varios recubrimientos. Consulte precio y plazo de entrega.



CÓDIGO	MEDIDA	€/100		ESPEJOR MÁX. A FIJAR	CAPACIDAD DE TALADRADO		
BCPZ4214	4,2 x 14	2,527	PH2	6	0,70-2,00	500	12.000
BCPZ4223	4,2 x 23	3,737	PH2	15	0,70-2,00	500	12.000

BCP A2

Inoxidable A2. Huella PH

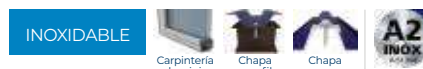

CÓDIGO	MEDIDA	€/100		ESPEJOR MÁX. A FIJAR	CAPACIDAD DE TALADRADO		
BCPA24214	4,2 x 14	21,853	PH2	6	0,70-2,00	500	12.000
BCPA24223	4,2 x 23	30,160	PH2	6	-	500	12.000

BCP N

Zincado negro. Huella PH



CÓDIGO	MEDIDA	€/100		ESPEJOR MÁX. A FIJAR	CAPACIDAD DE TALADRADO		
BCPN4214	4,2 x 14	3,767	PH2	6	0,70-2,00	500	12.000
BCPN4223	4,2 x 23	5,570	PH2	15	0,70-2,00	500	12.000

BCP B

Pintado blanco. Huella PH



CÓDIGO	MEDIDA	€/100		ESPEJOR MÁX. A FIJAR	CAPACIDAD DE TALADRADO		
BCPB4214	4,2 x 14	5,618	PH2	6	0,70-2,00	500	12.000
BCPB4223	4,2 x 23	8,461	PH2	15	0,70-2,00	500	12.000

BCP CB

Cabeza lacada blanca. Huella PH



CÓDIGO	MEDIDA	€/100		ESPEJOR MÁX. A FIJAR	CAPACIDAD DE TALADRADO		
BCPZ4214BL	4,2 x 14	10,338	PH2	6	0,70-2,00	500	22.500
BCPZ4223BL	4,2 x 23	13,254	PH2	15	0,70-2,00	500	12.000



Tornillo autotaladrante de cabeza alomada baja y arandela estampada

TAE

METAL



CÓDIGO	MEDIDA	€/100		ESPESOR MÁX. A FIJAR	CAPACIDAD DE TALADRADO		
TAEZ4213	4,2 x 13	4,047	PH2	4,3	0,75 - 2,50	500	12.000
TAEZ4216	4,2 x 16	4,467	PH2	7,3	0,75 - 2,50	500	8.000
TAEZ4219	4,2 x 19	4,983	PH2	10,3	0,75 - 2,50	500	6.000
TAEZ4225	4,2 x 25	5,100	PH2	16,3	0,75 - 2,50	500	6.000
TAEZ4232	4,2 x 32	5,978	PH2	23	0,75 - 2,50	500	6.000

TAEZ

Zincado. Huella PH



Disponible en varios recubrimientos. Consulte precio y plazo de entrega.

METAL



CÓDIGO	MEDIDA	€/100		ESPESOR MÁX. A FIJAR	CAPACIDAD DE TALADRADO		
TAEN4213	4,2 x 13	6,553	PH2	4,3	0,75 - 2,50	500	12.000
TAEN4216	4,2 x 16	7,000	PH2	7,3	0,75 - 2,50	500	8.000
TAEN4219	4,2 x 19	8,355	PH2	10,3	0,75 - 2,50	500	6.000
TAEN4225	4,2 x 25	9,942	PH2	16,3	0,75 - 2,50	500	6.000
TAEN4232	4,2 x 32	11,364	PH2	23	0,75 - 2,50	500	6.000

TAEN

Zincado negro. Huella PH



Tornillo rosca chapa con cabeza alomada

DIN-7981 H

METAL



CÓDIGO	MEDIDA	€/100			
T813509BLE	3,5 x 9,5	3,634	PH2	1.000	24.000
T814213BLE	4,2 x 13	5,776	PH2	500	12.000
T814225BLE	4,2 x 25	9,052	PH2	250	6.000

DIN-7981 HP B

Pintado blanco. Huella PH



METAL



CÓDIGO	MEDIDA	€/100			
TZN812909	2,9 x 9,5	2,165	PH1	1.000	30.000
TZN813513	3,5 x 13	2,860	PH2	500	15.000
TZN813516	3,5 x 16	3,499	PH2	500	12.000
TZN813519	3,5 x 19	3,972	PH2	500	12.000
TZN813525	3,5 x 25	5,157	PH2	250	6.000
TZN814216	4,2 x 16	4,573	PH2	500	12.000
TZN814219	4,2 x 19	4,951	PH2	500	8.000
TZN814225	4,2 x 25	5,655	PH2	250	6.000
TZN814232	4,2 x 32	7,800	PH2	250	6.000
TZN814238	4,2 x 38	8,832	PH2	250	3.000
TZN814816	4,8 x 16	6,374	PH2	250	6.000
TZN814819	4,8 x 19	7,028	PH2	250	6.000
TZN814822	4,8 x 22	7,471	PH2	250	6.000
TZN814825	4,8 x 25	7,413	PH2	250	6.000
TZN814838	4,8 x 38	10,906	PH2	250	3.000
TZN814850	4,8 x 50	14,822	PH2	250	3.000

DIN-7981 HP N

Zincado negro. Huella PH



DIN-7981 H

Tornillo rosca chapa con cabeza alomada

DIN-7981 HP Z

Zincado. Huella PH



Disponible en diferentes colores



Disponible en varios recubrimientos. Consulte precio y plazo de entrega.

CÓDIGO	MEDIDA	€/100	PH	Paquete 1	Paquete 2
T8129006	2,9 x 6,5	1,497	PH1	1.000	45.000
T8129009	2,9 x 9,5	1,547	PH1	1.000	30.000
T8129013	2,9 x 13	1,560	PH1	1.000	24.000
T8129016	2,9 x 16	1,747	PH1	1.000	24.000
T8129019	2,9 x 19	1,893	PH1	1.000	24.000
T8129022	2,9 x 22	2,265	PH1	1.000	12.000
T8129025	2,9 x 25	2,443	PH1	500	12.000
T8135006	3,5 x 6,5	1,560	PH2	1.000	24.000
T8135009	3,5 x 9,5	1,603	PH2	1.000	24.000
T8135013	3,5 x 13	1,907	PH2	500	15.000
T8135016	3,5 x 16	2,210	PH2	500	12.000
T8135019	3,5 x 19	2,407	PH2	500	12.000
T8135025	3,5 x 25	3,040	PH2	250	6.000
T8135032	3,5 x 32	3,787	PH2	250	6.000
T8139009	3,9 x 9,5	2,030	PH2	500	15.000
T8139013	3,9 x 13	2,330	PH2	500	12.000
T8139016	3,9 x 16	2,487	PH2	500	12.000
T8139019	3,9 x 19	2,897	PH2	500	12.000
T8139022	3,9 x 22	3,227	PH2	250	6.000
T8139025	3,9 x 25	3,577	PH2	250	6.000
T8139032	3,9 x 32	4,037	PH2	250	6.000
T8139038	3,9 x 38	4,727	PH2	250	6.000
T8139045	3,9 x 45	5,593	PH2	250	3.000
T8139050	3,9 x 50	6,207	PH2	250	3.000
T8142009	4,2 x 9,5	2,373	PH2	500	12.000
T8142013	4,2 x 13	2,560	PH2	500	12.000
T8142016	4,2 x 16	3,073	PH2	500	12.000
T8142019	4,2 x 19	3,167	PH2	500	8.000
T8142022	4,2 x 22	3,945	PH2	250	6.000
T8142025	4,2 x 25	3,947	PH2	250	6.000
T8142032	4,2 x 32	4,617	PH2	250	6.000
T8142038	4,2 x 38	5,403	PH2	250	3.000
T8142045	4,2 x 45	5,940	PH2	250	3.000
T8142050	4,2 x 50	6,540	PH2	250	3.000
T8142060	4,2 x 60	8,657	PH2	250	3.000
T8142070	4,2 x 70	9,727	PH2	250	1.500
T8142080	4,2 x 80	11,580	PH2	250	1.500
T8142090	4,2 x 90	15,737	PH2	250	1.500
T8148009	4,8 x 9,5	3,306	PH2	500	12.000
T8148013	4,8 x 13	3,432	PH2	500	8.000
T8148016	4,8 x 16	3,930	PH2	250	6.000
T8148019	4,8 x 19	4,607	PH2	250	6.000
T8148022	4,8 x 22	5,037	PH2	250	6.000

CÓDIGO	MEDIDA	€/100	PH	Paquete 1	Paquete 2
T8148025	4,8 x 25	5,171	PH2	250	6.000
T8148032	4,8 x 32	5,808	PH2	250	4.000
T8148038	4,8 x 38	6,929	PH2	250	3.000
T8148045	4,8 x 45	7,883	PH2	250	3.000
T8148050	4,8 x 50	8,580	PH2	250	3.000
T8148060	4,8 x 60	10,810	PH2	250	1.500
T8148070	4,8 x 70	12,847	PH2	100	1.200
T8148080	4,8 x 80	15,770	PH2	100	1.200
T8148090	4,8 x 90	18,273	PH2	100	1.200
T8148100	4,8 x 100	20,320	PH2	100	1.200
T8148110	4,8 x 110	25,496	PH2	100	1.200
T8148120	4,8 x 120	30,102	PH2	100	1.200
T8155013	5,5 x 13	5,173	PH3	250	6.000
T8155016	5,5 x 16	5,503	PH3	250	6.000
T8155019	5,5 x 19	5,914	PH3	250	6.000
T8155022	5,5 x 22	6,852	PH3	250	4.000
T8155025	5,5 x 25	6,913	PH3	250	4.000
T8155032	5,5 x 32	8,093	PH3	250	3.000
T8155038	5,5 x 38	9,043	PH3	250	3.000
T8155045	5,5 x 45	10,347	PH3	250	3.000
T8155050	5,5 x 50	11,307	PH3	250	1.500
T8155060	5,5 x 60	14,050	PH3	100	1.200
T8155070	5,5 x 70	15,597	PH3	100	1.200
T8155080	5,5 x 80	19,450	PH3	100	1.200
T8155090	5,5 x 90	22,850	PH3	100	1.200
T8155100	5,5 x 100	26,701	PH3	100	1.200
T8155110	5,5 x 110	32,341	PH3	100	1.200
T8155120	5,5 x 120	38,643	PH3	100	1.200
T8163016	6,3 x 16	7,339	PH3	250	4.000
T8163019	6,3 x 19	8,029	PH3	250	3.000
T8163022	6,3 x 22	8,420	PH3	250	3.000
T8163025	6,3 x 25	8,941	PH3	250	3.000
T8163032	6,3 x 32	10,988	PH3	250	3.000
T8163038	6,3 x 38	12,707	PH3	250	1.500
T8163045	6,3 x 45	14,873	PH3	250	1.500
T8163050	6,3 x 50	16,247	PH3	250	1.500
T8163060	6,3 x 60	19,179	PH3	100	1.200
T8163070	6,3 x 70	21,343	PH3	100	1.200
T8163080	6,3 x 80	26,400	PH3	100	1.200
T8163090	6,3 x 90	33,817	PH3	50	600
T8163100	6,3 x 100	37,333	PH3	50	600
T8163110	6,3 x 110	40,947	PH3	50	600
T8163120	6,3 x 120	43,930	PH3	50	600

Blíster

CÓDIGO	MEDIDA	€/BOLSA	PCS	BOLSAS
BZT8135009	3,5 x 9,5	1,943	40	20
BZT8135013	3,5 x 13	1,943	20	20
BZT8135016	3,5 x 16	1,943	20	20
BZT8135019	3,5 x 19	1,943	20	20
BZT8139013	3,9 x 13	1,943	20	20
BZT8139016	3,9 x 16	1,943	20	20
BZT8139019	3,9 x 19	1,943	20	20
BZT8139025	3,9 x 25	1,943	10	20
BZT8139032	3,9 x 32	1,943	10	20
BZT8142009	4,2 x 9,5	1,943	20	20
BZT8142013	4,2 x 13	1,943	20	20
BZT8142016	4,2 x 16	1,943	20	20
BZT8142019	4,2 x 19	1,943	20	20
BZT8142025	4,2 x 25	1,943	10	20
BZT8142032	4,2 x 32	1,943	10	20
BZT8142038	4,2 x 38	1,943	10	20
BZT8148016	4,8 x 16	1,943	10	20
BZT8148019	4,8 x 19	1,943	10	20
BZT8148025	4,8 x 25	1,943	10	20
BZT8148032	4,8 x 32	1,943	10	20
BZT8148038	4,8 x 38	1,943	10	20
BZT8148050	4,8 x 50	1,943	10	20
BZT8148060	4,8 x 60	1,943	10	20
BZT8155025	5,5 x 25	1,943	10	20
BZT8155032	5,5 x 32	1,943	10	20
BZT8155038	5,5 x 38	1,943	10	20
BZT8155050	5,5 x 50	1,943	10	20

Caja ventana

CÓDIGO	MEDIDA	€/CAJA	PCS	CAJAS
VT8135009	3,5 x 9,5	5,386	250	8
VT8135013	3,5 x 13	5,389	200	8
VT8135016	3,5 x 16	5,938	200	8
VT8135019	3,5 x 19	6,464	200	8
VT8135025	3,5 x 25	8,430	200	8
VT8139009	3,9 x 9,5	5,588	200	8
VT8139013	3,9 x 13	6,248	200	8
VT8139016	3,9 x 16	6,877	200	8
VT8139019	3,9 x 19	6,038	150	8
VT8139022	3,9 x 22	4,794	100	8
VT8139025	3,9 x 25	5,020	100	8
VT8142009	4,2 x 9,5	6,732	200	8
VT8142013	4,2 x 13	6,846	200	8
VT8142016	4,2 x 16	8,160	200	8
VT8142019	4,2 x 19	6,482	150	8
VT8142022	4,2 x 22	5,364	100	8
VT8142025	4,2 x 25	5,184	100	8
VT8142032	4,2 x 32	6,118	100	8
VT8142038	4,2 x 38	5,403	75	8
VT8142050	4,2 x 50	4,743	50	8
VT8148009	4,8 x 9,5	6,593	150	8
VT8148013	4,8 x 13	6,868	150	8
VT8148016	4,8 x 16	5,161	100	8
VT8148019	4,8 x 19	5,864	100	8
VT8148025	4,8 x 25	6,968	100	8
VT8148032	4,8 x 32	7,648	100	8
VT8148038	4,8 x 38	9,669	100	8
VT8148045	4,8 x 45	7,782	70	8
VT8148050	4,8 x 50	5,958	50	8
VT8148060	4,8 x 60	7,503	50	8
VT8148070	4,8 x 70	7,142	40	8
VT8148080	4,8 x 80	5,708	25	8
VT8155019	5,5 x 19	7,924	100	8
VT8155025	5,5 x 25	8,502	90	8
VT8155032	5,5 x 32	10,912	100	8
VT8155038	5,5 x 38	9,341	75	8



Tornillo rosca chapa con cabeza avellanada

DIN-7982 H



CÓDIGO	MEDIDA	€/100			
T8229006	2,9 x 6,5	1,653	PH1	1.000	45.000
T8229009	2,9 x 9,5	1,417	PH1	1.000	45.000
T8229013	2,9 x 13	1,430	PH1	1.000	45.000
T8229016	2,9 x 16	1,583	PH1	1.000	24.000
T8229019	2,9 x 19	1,793	PH1	1.000	24.000
T8229022	2,9 x 22	1,813	PH1	1.000	24.000
T8229025	2,9 x 25	2,267	PH1	500	12.000
T8235009	3,5 x 9,5	1,587	PH2	1.000	24.000
T8235013	3,5 x 13	1,783	PH2	500	22.500
T8235016	3,5 x 16	2,000	PH2	500	22.500
T8235019	3,5 x 19	2,210	PH2	500	12.000
T8235022	3,5 x 22	2,408	PH2	500	12.000
T8235025	3,5 x 25	2,948	PH2	250	11.250
T8235032	3,5 x 32	3,508	PH2	250	6.000
T8235038	3,5 x 38	4,067	PH2	250	6.000
T8239009	3,9 x 9,5	1,907	PH2	500	22.500
T8239013	3,9 x 13	2,036	PH2	500	12.000
T8239016	3,9 x 16	2,360	PH2	500	12.000
T8239019	3,9 x 19	2,603	PH2	500	12.000
T8239022	3,9 x 22	3,237	PH2	250	6.000
T8239025	3,9 x 25	3,527	PH2	250	6.000
T8239032	3,9 x 32	4,270	PH2	250	6.000
T8239038	3,9 x 38	4,667	PH2	250	6.000
T8239045	3,9 x 45	5,303	PH2	250	3.000
T8239050	3,9 x 50	6,227	PH2	250	3.000
T8242013	4,2 x 13	2,283	PH2	500	15.000
T8242016	4,2 x 16	2,537	PH2	500	12.000
T8242019	4,2 x 19	3,024	PH2	500	12.000
T8242022	4,2 x 22	3,573	PH2	250	11.250
T8242025	4,2 x 25	3,755	PH2	250	6.000
T8242032	4,2 x 32	4,412	PH2	250	6.000
T8242038	4,2 x 38	5,204	PH2	250	6.000
T8242045	4,2 x 45	6,013	PH2	250	3.000

CÓDIGO	MEDIDA	€/100			
T8242050	4,2 x 50	6,723	PH2	250	3.000
T8242060	4,2 x 60	8,527	PH2	250	3.000
T8242070	4,2 x 70	10,103	PH2	250	3.000
T8248013	4,8 x 13	3,067	PH2	500	12.000
T8248016	4,8 x 16	3,653	PH2	250	11.250
T8248019	4,8 x 19	4,271	PH2	250	6.000
T8248022	4,8 x 22	4,607	PH2	250	6.000
T8248025	4,8 x 25	5,227	PH2	250	6.000
T8248032	4,8 x 32	5,837	PH2	250	6.000
T8248038	4,8 x 38	7,027	PH2	250	3.000
T8248045	4,8 x 45	7,930	PH2	250	3.000
T8248050	4,8 x 50	9,473	PH2	250	3.000
T8248060	4,8 x 60	10,787	PH2	250	1.500
T8248070	4,8 x 70	13,437	PH2	100	2.400
T8255013	5,5 x 13	4,307	PH3	250	7.500
T8255016	5,5 x 16	4,827	PH3	250	6.000
T8255019	5,5 x 19	5,543	PH3	250	6.000
T8255022	5,5 x 22	6,457	PH3	250	6.000
T8255025	5,5 x 25	6,817	PH3	250	6.000
T8255032	5,5 x 32	7,877	PH3	250	3.000
T8255038	5,5 x 38	8,747	PH3	250	3.000
T8255045	5,5 x 45	10,437	PH3	250	3.000
T8255050	5,5 x 50	13,047	PH3	250	1.500
T8255060	5,5 x 60	14,847	PH3	100	1.200
T8255070	5,5 x 70	16,697	PH3	100	1.200
T8263025	6,3 x 25	9,700	PH3	250	3.000
T8263032	6,3 x 32	11,742	PH3	250	3.000
T8263038	6,3 x 38	12,403	PH3	250	3.000
T8263045	6,3 x 45	12,617	PH3	250	1.500
T8263050	6,3 x 50	15,130	PH3	250	1.500
T8263060	6,3 x 60	21,130	PH3	100	1.200
T8263070	6,3 x 70	22,097	PH3	100	1.200



Disponible en diferentes colores



Disponible en varios recubrimientos. Consulte precio y plazo de entrega.

Blíster

CÓDIGO	MEDIDA	€/BOLSA	PCS	BOLSAS
BZT8242019	4,2 x 19	1,943	20	20
BZT8242025	4,2 x 25	1,943	10	20
BZT8248025	4,8 x 25	1,943	10	20
BZT8248038	4,8 x 38	1,943	10	20

Caja ventana

CÓDIGO	MEDIDA	€/CAJA	PCS	CAJAS
VT8235009	3,5 x 9,5	5,361	250	8
VT8235013	3,5 x 13	4,758	200	8
VT8235016	3,5 x 16	5,225	200	8
VT8235019	3,5 x 19	5,788	200	8
VT8235025	3,5 x 25	4,001	100	8
VT8239016	3,9 x 16	6,008	200	8
VT8239019	3,9 x 19	6,729	200	8
VT8239022	3,9 x 22	4,670	100	8
VT8239025	3,9 x 25	4,879	100	8
VT8242016	4,2 x 16	6,594	200	8
VT8242019	4,2 x 19	7,212	200	8
VT8242025	4,2 x 25	4,827	100	8
VT8242032	4,2 x 32	5,711	100	8
VT8248019	4,8 x 19	5,365	100	8
VT8248025	4,8 x 25	6,577	100	8
VT8248032	4,8 x 32	6,802	95	8
VT8248038	4,8 x 38	7,014	80	8
VT8255032	5,5 x 32	7,664	75	8
VT8255038	5,5 x 38	8,134	70	8

LACADO DE TORNILLOS COMPLETO



DIÁMETRO	LONGITUD	CANTIDAD MÍNIMA
Min. 2,9 mm - Max. 5,5 mm	Min. 6,5 mm - Max. 32 mm	15 Kgs (*) (*) Por medida y color

Colores disponibles

	RAL 3005 Rojo vino		RAL 9005 Negro intenso
	RAL 5009 Azul azur		RAL 9010 Blanco puro
	RAL 6005 Verde musgo		



CONSULTE PRECIO Y PLAZO DE ENTREGA

LACADO DE TORNILLOS SOLO CABEZA



DIÁMETRO	LONGITUD	CANTIDAD MÍNIMA
Min. 3,9 mm - Max. 6,3 mm	Min. 13 mm - Max. 90 mm	(*) (*) Consultar cantidad mínima

Colores disponibles

	RAL 1000 Crema Bidasoa		RAL 7016 Gris antracita
	RAL 1001 Beige		RAL 7021 Gris negruzco
	RAL 1007 Amarillo narciso		RAL 7022 Gris sombra
	RAL 1011 Beige pardo		RAL 7024 Gris grafito
	RAL 1015 Marfil claro		RAL 7032 Gris guijarro
	RAL 3002 Rojo carmin		RAL 7033 Gris cemento
	RAL 3003 Rojo rubí		RAL 7034 Gris amarillento
	RAL 3004 Rojo púrpura		RAL 7035 Gris luminoso
	RAL 3005 Rojo vino		RAL 7040 Gris ventana
	RAL 3009 Rojo óxido		RAL 7045 Gris tele
	RAL 3011 Rojo pardo		RAL 8003 Pardo arcilla
	RAL 3020 Rojo tráfico		RAL 8004 Pardo cobre
	RAL 5002 Azul ultramar		RAL 8012 Pardo rojo
	RAL 5003 Azul zafiro		RAL 8014 Sepia
	RAL 5005 Azul señales		RAL 8017 Chocolate
	RAL 5008 Azul grisáceo		RAL 8019 Pardo grisáceo
	RAL 5009 Azul azur		RAL 8024 Pardo beige
	RAL 5010 Azul genciana		RAL 8025 Pardo pálido
	RAL 5011 Azul acero		RAL 9002 Blanco grisáceo
	RAL 5019 Azul capri		RAL 9003 Blanco señales
	RAL 6005 Verde musgo		RAL 9005 Negro intenso
	RAL 6009 Verde abeto		RAL 9006 Aluminio blanco
	RAL 6021 Verde pálido		RAL 9007 Aluminio gris
	RAL 6022 Verde oliva		RAL 9010 Blanco puro
	RAL 6028 Verde pino		RAL 9011 Negro grafito
	RAL 7011 Gris hierro		RAL 9016 Blanco tráfico
	RAL 7012 Gris basalto		RAL 9018 Blanco papiro
	RAL 7015 Gris pizarra		

Ponemos a su disposición una amplia gama de tornillos, que podrá lacar a su gusto entre los colores disponibles.

154 DIN-7504-K



156 DIN-7504-K RE



158 AUE



165 DIN-7504-N HP



171 DIN-7981 HP



173 DIN-7982 HP



Tornillo rosca chapa con cabeza extraplana

CP

CÓDIGO	MEDIDA	€/100		ESPEJOR MÁX. A FIJAR	METAL	
						
TCPZ4213	4,2 x 13	2,543	PH2	6	500	12.000
TCPZ4222	4,2 x 22	3,653	PH2	15	500	12.000
TCPZ4232	4,2 x 32	4,870	PH2	25	500	6.000

CP-Z

Zincado. Huella PH

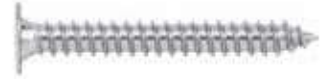

Disponible en varios recubrimientos. Consulte precio y plazo de entrega.

CÓDIGO	MEDIDA	€/100		ESPEJOR MÁX. A FIJAR	INOXIDABLE	
						
TCPA24213	4,2 x 13	9,320	PH2	6	500	12.000
TCPA24222	4,2 x 22	16,507	PH2	15	500	12.000
TCPA24232	4,2 x 32	20,137	PH2	25	500	6.000

CP-A2

Inoxidable A2. Huella PH

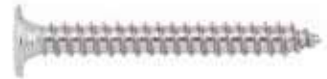

CÓDIGO	MEDIDA	€/100		ESPEJOR MÁX. A FIJAR	METAL	
						
TCPB4213	4,2 x 13	5,111	PH2	6	500	12.000
TCPB4222	4,2 x 22	7,872	PH2	15	500	12.000
TCPB4232	4,2 x 32	10,656	PH2	25	500	6.000

CP-B

Pintado blanco. Huella PH



CÓDIGO	MEDIDA	€/100		ESPEJOR MÁX. A FIJAR	METAL	
						
TCPN4213	4,2 x 13	3,707	PH2	6	500	12.000
TCPN4222	4,2 x 22	5,577	PH2	15	500	12.000
TCPN4232	4,2 x 32	7,730	PH2	25	500	6.000

CP-N

Zincado negro. Huella PH



PVC

Tornillos para carpintería de PVC

PVC-10 Z

Zincado. Diámetro de cabeza 7,5 mm



Disponible en varios recubrimientos. Consulte precio y plazo de entrega.

METAL



CÓDIGO	MEDIDA	€/100			
P103925Z	3,9 x 25	3,453	PH2	1.000	12.000
P103930Z	3,9 x 30	3,971	PH2	1.000	12.000
P103938Z	3,9 x 38	4,903	PH2	500	6.000
P103945Z	3,9 x 45	5,740	PH2	500	3.000

PVC-20 B

Bicromatado. Diámetro de cabeza 7 mm



Disponible en varios recubrimientos. Consulte precio y plazo de entrega.

METAL



CÓDIGO	MEDIDA	€/100			
P204325	4,3 x 25	3,441	PH2	1.000	12.000
P204330	4,3 x 30	4,000	PH2	1.000	6.000
P204338	4,3 x 38	4,887	PH2	500	6.000
P204345	4,3 x 45	6,030	PH2	500	3.000
P204355	4,3 x 55	6,920	PH2	500	3.000

PVC-20 Z

Zincado. Diámetro de cabeza 7 mm



Disponible en varios recubrimientos. Consulte precio y plazo de entrega.

METAL



CÓDIGO	MEDIDA	€/100			
P204316Z	4,3 x 16	2,863	PH2	1.000	24.000
P204319Z	4,3 x 19	3,030	PH2	1.000	12.000
P204322Z	4,3 x 22	3,309	PH2	1.000	12.000
P204325Z	4,3 x 25	3,441	PH2	1.000	12.000
P204330Z	4,3 x 30	4,000	PH2	1.000	6.000
P204338Z	4,3 x 38	4,887	PH2	500	6.000
P204345Z	4,3 x 45	6,030	PH2	500	3.000
P204355Z	4,3 x 55	6,920	PH2	500	3.000

PVC-30

Bicromatado. Tornillo de reparación, diámetro de cabeza de 7,5 mm

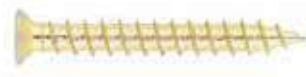

Disponible en varios recubrimientos. Consulte precio y plazo de entrega.

METAL



CÓDIGO	MEDIDA	€/100			
P304825	4,8 x 25	6,103	PH2	500	6.000
P304838	4,8 x 38	8,627	PH2	500	6.000

PVC-40 B

Bicromatado. Punta broca piloto



Disponible en varios recubrimientos. Consulte precio y plazo de entrega.

METAL





CÓDIGO	MEDIDA	€/100			
P403916	3,9 x 16	3,047	PH2	1.000	16.000
P403919	3,9 x 19	3,343	PH2	1.000	12.000
P403925	3,9 x 25	4,020	PH2	1.000	12.000
P403932	3,9 x 32	4,915	PH2	1.000	6.000
P403938	3,9 x 38	5,728	PH2	500	6.000

Tornillos para carpintería de PVC

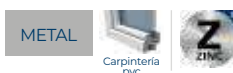
PVC



CÓDIGO	MEDIDA	€/100			
P403913Z	3,9 x 13	2,430	PH2	1.000	24.000
P403916Z	3,9 x 16	3,047	PH2	1.000	16.000
P403919Z	3,9 x 19	3,343	PH2	1.000	12.000
P403925Z	3,9 x 25	4,020	PH2	1.000	12.000
P403932Z	3,9 x 32	4,915	PH2	1.000	6.000
P403938Z	3,9 x 38	5,728	PH2	500	6.000

PVC-40 Z

Zincado. Punta broca piloto



Disponible en varios recubrimientos. Consulte precio y plazo de entrega.

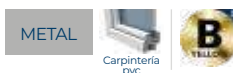

CÓDIGO	MEDIDA	€/100			
P50M416	M4 x 16	3,263	PH2	1.000	16.000
P50M419	M4 x 19	3,825	PH2	1.000	12.000
P50M425	M4 x 25	4,777	PH2	1.000	12.000
P50M432	M4 x 32	5,468	PH2	1.000	6.000
P50M438	M4 x 38	6,893	PH2	500	6.000

PVC-50 B

Bicromatado. Rosca métrica, punta broca



CÓDIGO	MEDIDA	€/100			
P50M413Z	M4 x 13	3,004	PH2	1.000	24.000
P50M416Z	M4 x 16	3,263	PH2	1.000	16.000
P50M419Z	M4 x 19	3,825	PH2	1.000	12.000
P50M425Z	M4 x 25	4,777	PH2	1.000	12.000
P50M432Z	M4 x 32	5,468	PH2	1.000	6.000



PVC-50 Z

Zincado. Rosca métrica, punta broca



Disponible en varios recubrimientos. Consulte precio y plazo de entrega.



CÓDIGO	MEDIDA	€/100			
P704855	4,8 x 55	11,447	PH2	500	3.000
P704865	4,8 x 65	15,093	PH2	500	2.000
P704880	4,8 x 80	20,157	PH2	250	1.500
P704895	4,8 x 95	29,697	PH2	250	1.500

PVC-70

Bicromatado. Cabeza especial para tapón

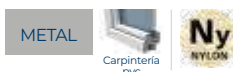

CÓDIGO	DIÁMETRO	COLOR	€/100		
P70TPBL	13	BLANCO	3,920	1.000	24.000
P70TPNG	13	NEGRO	3,920	1.000	24.000

PVC-70 TP

Tapón de nylon: blanco y negro para tornillo PVC-70



PVC

Tornillos para carpintería de PVC

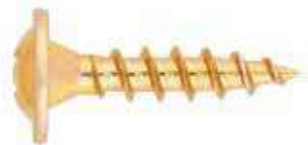

PVC-90

Bicromatado. Cabeza alomada baja con arandela



METAL



CÓDIGO	MEDIDA	€/100			
P903510	3,5 x 10	3,630	PH2	1.000	24.000
P904017	4 x 17	5,480	PH2	1.000	12.000

PVC-VEK

VEKAPLAST con cabeza especial



METAL



CÓDIGO	MEDIDA	€/100			
P100VEK	VEKAPLAST 4,8 x 10	18,403	PH2	500	6.000



Disponible en varios recubrimientos. Consulte precio y plazo de entrega.



PVC-VEK 13

VEKAPLAST con cabeza especial y broca



METAL



CÓDIGO	MEDIDA	€/100			
P100VEK13	VEKAPLAST 4 x 10	17,037	PH2	500	12.000

PVC-VEK 10

VEKAPLAST con cabeza especial



METAL



CÓDIGO	MEDIDA	€/100		
P100VEK10	VEKAPLAST 4 x 10	15,247	PH2	500



PVC-KOM 10

KOMMERLING con cabeza especial



METAL



CÓDIGO	MEDIDA	€/100			
P100KOM10	KOMMERLING 5,5 x 10	24,107	PH2	500	6.000



Disponible en varios recubrimientos. Consulte precio y plazo de entrega.



TORNILLOS PARA MADERA



TEX-BP

Bicromatado. Huella PZ



CÓDIGO	MEDIDA	€/100		UD. MIN. VENTA		
••TEXBP25010	2,5 x 10	1,202	PZ1	2.000	1.000	45.000
••TEXBP25012	2,5 x 12	1,254	PZ1	2.000	1.000	45.000
••TEXBP25016	2,5 x 16	1,408	PZ1	2.000	1.000	45.000
••TEXBP25020	2,5 x 20	1,561	PZ1	2.000	1.000	24.000
••TEXBP25025	2,5 x 25	1,738	PZ1	2.000	1.000	24.000
••TEXBP30012	3 x 12	1,509	PZ1	2.000	1.000	45.000
••TEXBP30015	3 x 15	1,633	PZ1	2.000	1.000	24.000
••TEXBP30016	3 x 16	1,751	PZ1	2.000	1.000	24.000
••TEXBP30020	3 x 20	1,934	PZ1	2.000	1.000	24.000
••TEXBP30025	3 x 25	2,034	PZ1	2.000	1.000	24.000
••TEXBP30030	3 x 30	2,698	PZ1	2.000	1.000	12.000
••TEXBP30035	3 x 35	2,902	PZ1	2.000	1.000	12.000
••TEXBP30040	3 x 40	3,541	PZ1	2.000	1.000	6.000
••TEXBP30045	3 x 45	3,904	PZ1	1.000	500	6.000
••TEXBP35010	3,5 x 10	1,806	PZ2	2.000	1.000	24.000
••TEXBP35012	3,5 x 12	1,950	PZ2	2.000	1.000	24.000
••TEXBP35015	3,5 x 15	1,806	PZ2	2.000	1.000	24.000
••TEXBP35016	3,5 x 16	2,261	PZ2	2.000	1.000	24.000
••TEXBP35020	3,5 x 20	2,401	PZ2	2.000	1.000	24.000
••TEXBP35025	3,5 x 25	2,852	PZ2	2.000	1.000	12.000
••TEXBP35030	3,5 x 30	3,293	PZ2	2.000	1.000	12.000
••TEXBP35035	3,5 x 35	3,735	PZ2	2.000	1.000	12.000
••TEXBP35040	3,5 x 40	4,236	PZ2	1.000	500	6.000
••TEXBP35045	3,5 x 45	5,403	PZ2	1.000	500	6.000
••TEXBP35050	3,5 x 50	6,342	PZ2	1.000	500	6.000
••TEXBP40012	4 x 12	2,306	PZ2	2.000	1.000	24.000
••TEXBP40015	4 x 15	2,296	PZ2	2.000	1.000	24.000
••TEXBP40016	4 x 16	2,630	PZ2	2.000	1.000	24.000
••TEXBP40020	4 x 20	3,010	PZ2	2.000	1.000	12.000
••TEXBP40025	4 x 25	3,381	PZ2	2.000	1.000	12.000
••TEXBP40030	4 x 30	3,993	PZ2	2.000	1.000	6.000
••TEXBP40035	4 x 35	4,557	PZ2	1.000	500	6.000
••TEXBP40040	4 x 40	4,957	PZ2	1.000	500	3.000
••TEXBP40045	4 x 45	5,968	PZ2	1.000	500	3.000
••TEXBP40050	4 x 50	5,998	PZ2	1.000	500	3.000
••TEXBP40055	4 x 55	7,196	PZ2	500	250	1.500
••TEXBP40060	4 x 60	8,639	PZ2	500	250	3.000
••TEXBP40070	4 x 70	10,143	PZ2	500	250	1.500
••TEXBP40080	4 x 80	10,329	PZ2	500	250	1.500
••TEXBP45016	4,5 x 16	2,865	PZ2	2.000	1.000	12.000
••TEXBP45020	4,5 x 20	3,943	PZ2	2.000	1.000	12.000
••TEXBP45025	4,5 x 25	4,490	PZ2	2.000	1.000	12.000
••TEXBP45030	4,5 x 30	4,877	PZ2	1.000	500	6.000
••TEXBP45035	4,5 x 35	5,733	PZ2	1.000	500	6.000
••TEXBP45040	4,5 x 40	6,087	PZ2	1.000	500	3.000
••TEXBP45045	4,5 x 45	7,257	PZ2	500	250	3.000
••TEXBP45050	4,5 x 50	7,217	PZ2	500	250	3.000
••TEXBP45060	4,5 x 60	10,237	PZ2	500	250	1.500
••TEXBP45070	4,5 x 70	12,547	PZ2	500	250	1.500
••TEXBP45080	4,5 x 80	14,653	PZ2	200	100	1.200
••TEXBP50025	5 x 25	5,148	PZ2	2.000	1.000	6.000
••TEXBP50030	5 x 30	6,317	PZ2	1.000	500	6.000
••TEXBP50035	5 x 35	6,587	PZ2	1.000	500	6.000
••TEXBP50040	5 x 40	7,740	PZ2	1.000	500	6.000
••TEXBP50045	5 x 45	8,990	PZ2	500	250	3.000
••TEXBP50050	5 x 50	9,250	PZ2	500	250	3.000
••TEXBP50060	5 x 60	11,510	PZ2	500	250	1.500
••TEXBP50070	5 x 70	13,513	PZ2	400	200	1.200
••TEXBP50080	5 x 80	17,997	PZ2	200	100	1.200
••TEXBP50090	5 x 90	18,503	PZ2	200	100	1.200
••TEXBP50100	5 x 100	23,907	PZ2	200	100	1.200
••TEXBP50110	5 x 110	23,664	PZ2	200	100	1.200
••TEXBP50120	5 x 120	30,113	PZ2	200	100	1.200
••TEXBP60040	6 x 40	14,137	PZ3	500	250	3.000
••TEXBP60045	6 x 45	14,400	PZ3	500	250	3.000
••TEXBP60050	6 x 50	16,457	PZ3	500	250	1.500
••TEXBP60060	6 x 60	18,337	PZ3	500	250	1.500
••TEXBP60070	6 x 70	19,770	PZ3	200	100	1.200
••TEXBP60080	6 x 80	26,713	PZ3	200	100	1.200
••TEXBP60090	6 x 90	31,070	PZ3	200	100	600
••TEXBP60100	6 x 100	30,353	PZ3	200	100	600
••TEXBP60110	6 x 110	40,803	PZ3	200	100	600
••TEXBP60120	6 x 120	45,099	PZ3	200	100	600

• Medidas sin homologar
• Hasta fin de existencias

Blíster

CÓDIGO	MEDIDA	€/BOLSA	PCS B	BOLSAS
BZTXBP30016	3 x 16	2,459	40	20
BZTXBP30020	3 x 20	2,459	40	20
BZTXBP30025	3 x 25	2,459	40	20
BZTXBP30030	3 x 30	2,459	40	20
BZTXBP35016	3,5 x 16	2,459	40	20
BZTXBP35020	3,5 x 20	2,459	40	20
BZTXBP35025	3,5 x 25	2,459	40	20
BZTXBP35030	3,5 x 30	2,459	40	20
BZTXBP35035	3,5 x 35	2,459	20	20
BZTXBP35040	3,5 x 40	2,459	20	20
BZTXBP35050	3,5 x 50	2,459	20	20
BZTXBP40025	4 x 25	2,459	40	20
BZTXBP40030	4 x 30	2,459	20	20
BZTXBP40035	4 x 35	2,459	20	20
BZTXBP40040	4 x 40	2,459	20	20
BZTXBP40045	4 x 45	2,459	20	20
BZTXBP40050	4 x 50	2,459	10	20
BZTXBP40060	4 x 60	2,459	10	20
BZTXBP45030	4,5 x 30	2,459	20	20
BZTXBP45035	4,5 x 35	2,459	20	20
BZTXBP45040	4,5 x 40	2,459	20	20
BZTXBP45045	4,5 x 45	2,459	10	20
BZTXBP45050	4,5 x 50	2,459	10	20
BZTXBP45060	4,5 x 60	2,459	10	20
BZTXBP45070	4,5 x 70	2,459	10	20
BZTXBP50030	5 x 30	2,459	10	20
BZTXBP50035	5 x 35	2,459	10	20
BZTXBP50040	5 x 40	2,459	10	20
BZTXBP50050	5 x 50	2,459	10	20
BZTXBP50060	5 x 60	2,459	10	20
BZTXBP50070	5 x 70	2,459	4	20
BZTXBP50080	5 x 80	2,459	4	20
BZTXBP60050	6 x 50	2,459	10	20
BZTXBP60060	6 x 60	2,459	10	20
BZTXBP60070	6 x 70	2,459	4	20
BZTXBP60080	6 x 80	2,459	4	20

Caja ventana

CÓDIGO	MEDIDA	€/CAJA	PCS	CAJAS
VTEXBP30016	3 x 16	4,738	200	8
VTEXBP30020	3 x 20	5,095	200	8
VTEXBP30025	3 x 25	5,146	200	8
VTEXBP30030	3 x 30	5,864	170	8
VTEXBP30040	3 x 40	5,767	120	8
VTEXBP35016	3,5 x 16	5,441	200	8
VTEXBP35020	3,5 x 20	6,102	200	8
VTEXBP35025	3,5 x 25	5,821	170	8
VTEXBP35030	3,5 x 30	5,944	150	8
VTEXBP35035	3,5 x 35	4,981	100	8
VTEXBP35040	3,5 x 40	3,854	75	8
VTEXBP35050	3,5 x 50	6,353	75	8
VTEXBP40025	4 x 25	5,415	125	8
VTEXBP40030	4 x 30	5,023	100	8
VTEXBP40035	4 x 35	3,930	75	8
VTEXBP40040	4 x 40	4,256	75	8
VTEXBP40045	4 x 45	5,377	75	8
VTEXBP40050	4 x 50	3,667	50	8
VTEXBP40060	4 x 60	5,235	50	8
VTEXBP45030	4,5 x 30	6,014	100	8
VTEXBP45035	4,5 x 35	5,304	75	8
VTEXBP45040	4,5 x 40	5,222	75	8
VTEXBP45045	4,5 x 45	4,703	50	8
VTEXBP45050	4,5 x 50	4,519	50	8
VTEXBP45060	4,5 x 60	6,286	50	8
VTEXBP45070	4,5 x 70	7,711	50	8
VTEXBP50030	5 x 30	5,731	75	8
VTEXBP50035	5 x 35	5,807	75	8
VTEXBP50040	5 x 40	4,795	50	8
VTEXBP50050	5 x 50	5,446	50	8
VTEXBP50060	5 x 60	3,550	25	8
VTEXBP50070	5 x 70	4,449	25	8
VTEXBP50080	5 x 80	5,054	25	8
VTEXBP50090	5 x 90	5,710	25	8
VTEXBP60050	6 x 50	7,540	40	8
VTEXBP60060	6 x 60	6,172	30	8

Caja ventana

CÓDIGO	MEDIDA	€/CAJA	PCS	CAJAS
VTEXBP60070	6 x 70	4,867	20	8
VTEXBP60080	6 x 80	5,864	20	8



Tirafondo de alto rendimiento

TEX

MADERA



TEX-ZP

Cincado. Huella Pz

CÓDIGO	MEDIDA	€/100		UD. MIN. VENTA		
•TEXZP25010	2,5 x 10	1,202	PZ1	2.000	1.000	45.000
•TEXZP25012	2,5 x 12	1,254	PZ1	2.000	1.000	45.000
•TEXZP25016	2,5 x 16	1,408	PZ1	2.000	1.000	45.000
•TEXZP25020	2,5 x 20	1,561	PZ1	2.000	1.000	45.000
•TEXZP25025	2,5 x 25	1,738	PZ1	2.000	1.000	45.000
•TEXZP30010	3 x 10	1,428	PZ1	2.000	1.000	45.000
•TEXZP30012	3 x 12	1,509	PZ1	2.000	1.000	45.000
•TEXZP30015	3 x 15	1,633	PZ1	2.000	1.000	24.000
•TEXZP30016	3 x 16	1,751	PZ1	2.000	1.000	24.000
•TEXZP30020	3 x 20	1,934	PZ1	2.000	1.000	24.000
•TEXZP30025	3 x 25	2,034	PZ1	2.000	1.000	24.000
TEXZP30030	3 x 30	2,698	PZ1	2.000	1.000	12.000
TEXZP30035	3 x 35	2,902	PZ1	2.000	1.000	12.000
TEXZP30040	3 x 40	3,541	PZ1	2.000	1.000	6.000
TEXZP30045	3 x 45	3,904	PZ1	1.000	500	6.000
•TEXZP35010	3,5 x 10	1,806	PZ2	2.000	1.000	24.000
•TEXZP35012	3,5 x 12	1,950	PZ2	2.000	1.000	24.000
•TEXZP35015	3,5 x 15	1,806	PZ2	2.000	1.000	24.000
•TEXZP35016	3,5 x 16	2,261	PZ2	2.000	1.000	24.000
•TEXZP35020	3,5 x 20	2,401	PZ2	2.000	1.000	24.000
TEXZP35025	3,5 x 25	2,852	PZ2	2.000	1.000	12.000
TEXZP35030	3,5 x 30	3,293	PZ2	2.000	1.000	12.000
TEXZP35035	3,5 x 35	3,735	PZ2	2.000	1.000	12.000
TEXZP35040	3,5 x 40	4,236	PZ2	1.000	500	6.000
TEXZP35045	3,5 x 45	5,403	PZ2	1.000	500	6.000
TEXZP35050	3,5 x 50	6,342	PZ2	1.000	500	6.000
•TEXZP40012	4 x 12	2,306	PZ2	2.000	1.000	24.000
•TEXZP40015	4 x 15	2,296	PZ2	2.000	1.000	24.000
•TEXZP40016	4 x 16	2,630	PZ2	2.000	1.000	24.000
•TEXZP40020	4 x 20	3,010	PZ2	2.000	1.000	12.000
•TEXZP40025	4 x 25	3,381	PZ2	2.000	1.000	12.000
TEXZP40030	4 x 30	3,993	PZ2	2.000	1.000	6.000
TEXZP40035	4 x 35	4,557	PZ2	1.000	500	6.000
TEXZP40040	4 x 40	4,957	PZ2	1.000	500	3.000
TEXZP40045	4 x 45	5,968	PZ2	1.000	500	3.000
TEXZP40050	4 x 50	5,998	PZ2	1.000	500	3.000
•TEXZP40055	4 x 55	7,196	PZ2	500	250	3.000
TEXZP40060	4 x 60	8,639	PZ2	500	250	3.000

CÓDIGO	MEDIDA	€/100		UD. MIN. VENTA		
TEXZP40070	4 x 70	10,143	PZ2	500	250	1.500
TEXZP40080	4 x 80	10,329	PZ2	500	250	1.500
•TEXZP45016	4,5 x 16	2,865	PZ2	2.000	1.000	12.000
•TEXZP45020	4,5 x 20	3,943	PZ2	2.000	1.000	12.000
•TEXZP45025	4,5 x 25	4,490	PZ2	2.000	1.000	12.000
•TEXZP45030	4,5 x 30	4,877	PZ2	1.000	500	6.000
TEXZP45035	4,5 x 35	5,733	PZ2	1.000	500	6.000
TEXZP45040	4,5 x 40	6,087	PZ2	1.000	500	3.000
TEXZP45045	4,5 x 45	7,257	PZ2	500	250	3.000
TEXZP45050	4,5 x 50	7,217	PZ2	500	250	3.000
TEXZP45060	4,5 x 60	10,237	PZ2	500	250	1.500
TEXZP45070	4,5 x 70	12,547	PZ2	500	250	1.500
TEXZP45080	4,5 x 80	14,653	PZ2	200	100	1.200
•TEXZP50025	5 x 25	5,148	PZ2	2.000	1.000	6.000
•TEXZP50030	5 x 30	6,317	PZ2	1.000	500	6.000
TEXZP50035	5 x 35	6,587	PZ2	1.000	500	6.000
TEXZP50040	5 x 40	7,740	PZ2	1.000	500	6.000
TEXZP50045	5 x 45	8,990	PZ2	500	250	3.000
TEXZP50050	5 x 50	9,250	PZ2	500	250	3.000
TEXZP50060	5 x 60	11,510	PZ2	500	250	1.500
TEXZP50070	5 x 70	13,513	PZ2	400	200	1.200
TEXZP50080	5 x 80	17,997	PZ2	200	100	1.200
TEXZP50090	5 x 90	18,503	PZ2	200	100	1.200
TEXZP50100	5 x 100	23,907	PZ2	200	100	1.200
•TEXZP50110	5 x 110	23,664	PZ2	200	100	1.200
TEXZP50120	5 x 120	30,113	PZ2	200	100	1.200
•TEXZP60040	6 x 40	14,137	PZ3	500	250	3.000
•TEXZP60045	6 x 45	14,400	PZ3	500	250	3.000
•TEXZP60050	6 x 50	16,457	PZ3	500	250	1.500
TEXZP60060	6 x 60	18,337	PZ3	500	250	1.500
TEXZP60070	6 x 70	19,770	PZ3	200	100	600
TEXZP60080	6 x 80	26,713	PZ3	200	100	1.200
TEXZP60090	6 x 90	31,070	PZ3	200	100	1.200
TEXZP60100	6 x 100	30,353	PZ3	200	100	600
TEXZP60110	6 x 110	40,803	PZ3	200	100	600
TEXZP60120	6 x 120	45,099	PZ3	200	100	600



Disponible en varios recubrimientos. Consulte precio y plazo de entrega.

• Medidas sin homologar
• Hasta fin de existencias

Blíster

CÓDIGO	MEDIDA	€/BOLSA	PCS	BOLSAS
BZTXZP30016	3 x 16	2,459	40	20
BZTXZP30020	3 x 20	2,459	40	20
BZTXZP30025	3 x 25	2,459	40	20
BZTXZP30030	3 x 30	2,459	40	20
BZTXZP35016	3,5 x 16	2,459	40	20
BZTXZP35020	3,5 x 20	2,459	40	20
BZTXZP35025	3,5 x 25	2,459	40	20
BZTXZP35030	3,5 x 30	2,459	40	20
BZTXZP35035	3,5 x 35	2,459	20	20
BZTXZP35040	3,5 x 40	2,459	20	20
BZTXZP35050	3,5 x 50	2,459	20	20
BZTXZP40025	4 x 25	2,459	40	20
BZTXZP40030	4 x 30	2,459	20	20
BZTXZP40035	4 x 35	2,459	20	20
BZTXZP40040	4 x 40	2,459	20	20
BZTXZP40045	4 x 45	2,459	20	20
BZTXZP40050	4 x 50	2,459	10	20
BZTXZP40060	4 x 60	2,459	10	20
BZTXZP45030	4,5 x 30	2,459	20	20
BZTXZP45035	4,5 x 35	2,459	20	20
BZTXZP45040	4,5 x 40	2,459	20	20
BZTXZP45045	4,5 x 45	2,459	10	20
BZTXZP45050	4,5 x 50	2,459	10	20
BZTXZP45060	4,5 x 60	2,459	10	20
BZTXZP45070	4,5 x 70	2,459	10	20
BZTXZP50030	5 x 30	2,459	10	20
BZTXZP50035	5 x 35	2,459	10	20
BZTXZP50040	5 x 40	2,459	10	20
BZTXZP50050	5 x 50	2,459	10	20
BZTXZP50060	5 x 60	2,459	10	20
BZTXZP50070	5 x 70	2,459	4	20
BZTXZP50080	5 x 80	2,459	4	20
BZTXZP60050	6 x 50	2,459	10	20
BZTXZP60060	6 x 60	2,459	10	20
BZTXZP60070	6 x 70	2,459	4	20
BZTXZP60080	6 x 80	2,459	4	20

Caja ventana

CÓDIGO	MEDIDA	€/CAJA	PCS	CAJAS
VTEXZP30016	3 x 16	4,738	200	8
VTEXZP30020	3 x 20	5,095	200	8
VTEXZP30025	3 x 25	5,146	200	8
VTEXZP30030	3 x 30	5,864	170	8
VTEXZP30040	3 x 40	5,767	120	8
VTEXZP35016	3,5 x 16	5,441	200	8
VTEXZP35020	3,5 x 20	6,102	200	8
VTEXZP35025	3,5 x 25	5,821	170	8
VTEXZP35030	3,5 x 30	5,944	150	8
VTEXZP35035	3,5 x 35	4,981	100	8
VTEXZP35040	3,5 x 40	3,854	75	8
VTEXZP35050	3,5 x 50	6,353	75	8
VTEXZP40025	4 x 25	5,415	125	8
VTEXZP40030	4 x 30	5,023	100	8
VTEXZP40035	4 x 35	3,930	75	8
VTEXZP40040	4 x 40	4,256	75	8
VTEXZP40045	4 x 45	5,377	75	8
VTEXZP40050	4 x 50	3,667	50	8
VTEXZP40060	4 x 60	5,235	50	8
VTEXZP45030	4,5 x 30	6,014	100	8
VTEXZP45035	4,5 x 35	5,304	75	8
VTEXZP45040	4,5 x 40	5,222	75	8
VTEXZP45045	4,5 x 45	4,703	50	8
VTEXZP45050	4,5 x 50	4,519	50	8
VTEXZP45060	4,5 x 60	6,286	50	8
VTEXZP45070	4,5 x 70	7,711	50	8
VTEXZP50030	5 x 30	5,731	75	8
VTEXZP50035	5 x 35	5,807	75	8
VTEXZP50040	5 x 40	4,795	50	8
VTEXZP50045	5 x 45	5,339	50	8
VTEXZP50050	5 x 50	5,446	50	8
VTEXZP50060	5 x 60	3,550	25	8
VTEXZP50070	5 x 70	4,449	25	8
VTEXZP50080	5 x 80	5,054	25	8
VTEXZP60050	6 x 50	7,540	40	8
VTEXZP60060	6 x 60	6,172	30	8
VTEXZP60070	6 x 70	4,867	20	8
VTEXZP60080	6 x 80	5,864	20	8

TEX-BT

Bicromatado. Huella TX



CÓDIGO	MEDIDA	€/100	UD. MIN. VENTA	UD. MIN. VENTA	UD. MIN. VENTA
• TEXBT30016	3 x 16	2,172	TX10	2.000	1.000 24.000
• TEXBT30020	3 x 20	2,251	TX10	2.000	1.000 24.000
• TEXBT30025	3 x 25	2,887	TX10	2.000	1.000 24.000
• TEXBT30030	3 x 30	3,329	TX10	2.000	1.000 12.000
• TEXBT30035	3 x 35	3,382	TX10	2.000	1.000 12.000
• TEXBT30040	3 x 40	3,802	TX10	2.000	1.000 6.000
• TEXBT35012	3,5 x 12	2,381	TX15	2.000	1.000 24.000
• TEXBT35016	3,5 x 16	2,506	TX15	2.000	1.000 24.000
• TEXBT35020	3,5 x 20	2,695	TX15	2.000	1.000 24.000
• TEXBT35025	3,5 x 25	3,368	TX15	2.000	1.000 12.000
• TEXBT35030	3,5 x 30	3,825	TX15	2.000	1.000 12.000
• TEXBT35035	3,5 x 35	4,051	TX15	2.000	1.000 12.000
• TEXBT35040	3,5 x 40	4,908	TX15	1.000	500 6.000
• TEXBT35045	3,5 x 45	5,645	TX15	1.000	500 6.000
• TEXBT35050	3,5 x 50	6,378	TX15	1.000	500 6.000
• TEXBT40016	4 x 16	2,787	TX20	2.000	1.000 24.000
• TEXBT40020	4 x 20	3,170	TX20	2.000	1.000 12.000
• TEXBT40025	4 x 25	3,518	TX20	2.000	1.000 12.000
• TEXBT40030	4 x 30	4,013	TX20	2.000	1.000 6.000
• TEXBT40035	4 x 35	4,851	TX20	1.000	500 6.000
• TEXBT40040	4 x 40	5,267	TX20	1.000	500 3.000
• TEXBT40045	4 x 45	6,566	TX20	1.000	500 3.000
• TEXBT40050	4 x 50	6,599	TX20	1.000	500 3.000
• TEXBT40055	4 x 55	7,520	TX20	500	250 3.000
• TEXBT40060	4 x 60	8,657	TX20	500	250 3.000
• TEXBT40070	4 x 70	10,182	TX20	500	250 1.500
• TEXBT45025	4,5 x 25	4,763	TX20	2.000	1.000 12.000
• TEXBT45030	4,5 x 30	4,897	TX20	1.000	500 6.000
• TEXBT45035	4,5 x 35	6,184	TX20	1.000	500 6.000
• TEXBT45040	4,5 x 40	6,287	TX20	1.000	500 3.000
• TEXBT45045	4,5 x 45	7,753	TX20	500	250 3.000
• TEXBT45050	4,5 x 50	7,260	TX20	500	250 3.000
• TEXBT45060	4,5 x 60	10,359	TX20	500	250 1.500
• TEXBT45070	4,5 x 70	13,827	TX20	500	250 1.500
• TEXBT45080	4,5 x 80	16,764	TX20	200	100 1.200
• TEXBT50030	5 x 30	7,083	TX25	1.000	500 6.000
• TEXBT50035	5 x 35	7,603	TX25	1.000	500 6.000
• TEXBT50040	5 x 40	8,097	TX25	1.000	500 6.000
• TEXBT50045	5 x 45	9,415	TX25	500	250 3.000
• TEXBT50050	5 x 50	10,163	TX25	500	250 3.000
• TEXBT50060	5 x 60	12,773	TX25	500	250 2.000
• TEXBT50070	5 x 70	14,747	TX25	400	200 1.200
• TEXBT50080	5 x 80	19,350	TX25	200	100 1.200
• TEXBT50090	5 x 90	19,110	TX25	200	100 1.200
• TEXBT50100	5 x 100	25,097	TX25	200	100 1.200
• TEXBT50120	5 x 120	32,207	TX25	200	100 1.200
• TEXBT60040	6 x 40	14,659	TX30	500	250 3.000
• TEXBT60045	6 x 45	14,873	TX30	500	250 3.000
• TEXBT60050	6 x 50	16,493	TX30	500	250 2.000
• TEXBT60060	6 x 60	19,061	TX30	500	250 1.500
• TEXBT60070	6 x 70	21,337	TX30	200	100 1.200
• TEXBT60080	6 x 80	27,059	TX30	200	100 1.200
• TEXBT60090	6 x 90	31,170	TX30	200	100 800
• TEXBT60100	6 x 100	34,209	TX30	200	100 800
• TEXBT60110	6 x 110	42,509	TX30	200	100 600
• TEXBT60120	6 x 120	45,362	TX30	200	100 1.200
• TEXBT60130	6 x 130	47,370	TX30	200	100 600
• TEXBT60140	6 x 140	59,845	TX30	200	100 600
• TEXBT60150	6 x 150	69,832	TX30	200	100 600
• TEXBT60160	6 x 160	75,310	TX30	100	100 600
• TEXBT60180	6 x 180	99,774	TX30	100	100 800
• TEXBT60200	6 x 200	118,728	TX30	100	100 800
• TEXBT60220	6 x 220	134,962	TX30	100	100 -
• TEXBT60240	6 x 240	160,423	TX30	100	100 -
• TEXBT60260	6 x 260	181,365	TX30	100	100 -
• TEXBT60280	6 x 280	211,837	TX30	100	100 -
• TEXBT60300	6 x 300	227,040	TX30	100	100 -
• TEXBT80080	8 x 80	48,030	TX40	200	100 600
• TEXBT80100	8 x 100	60,433	TX40	100	50 300
• TEXBT80120	8 x 120	87,890	TX40	100	50 400
• TEXBT80140	8 x 140	95,933	TX40	50	50 400
• TEXBT80160	8 x 160	129,265	TX40	50	50 400
• TEXBT80180	8 x 180	146,203	TX40	50	50 200
• TEXBT80200	8 x 200	167,987	TX40	50	50 400
• TEXBT80220	8 x 220	196,121	TX40	50	50 400
• TEXBT80240	8 x 240	219,027	TX40	50	50 400
• TEXBT80260	8 x 260	251,380	TX40	50	50 -
• TEXBT80280	8 x 280	251,370	TX40	50	50 -
• TEXBT80300	8 x 300	270,317	TX40	50	50 200
• TEXBT80320	8 x 320	325,974	TX40	50	50 -
• TEXBT80340	8 x 340	347,345	TX40	50	50 -
• TEXBT80360	8 x 360	420,309	TX40	50	50 -
• TEXBT80380	8 x 380	442,522	TX40	50	50 -
• TEXBT80400	8 x 400	509,048	TX40	50	50 -
• TEXBT10080	10 x 80	91,718	TX40	50	50 -
• TEXBT10100	10 x 100	101,136	TX40	50	50 400
• TEXBT10120	10 x 120	126,779	TX40	50	50 -
• TEXBT10140	10 x 140	152,929	TX40	50	50 -
• TEXBT10160	10 x 160	178,589	TX40	50	50 -
• TEXBT10180	10 x 180	240,077	TX40	50	50 -
• TEXBT10200	10 x 200	283,191	TX40	50	50 -
• TEXBT10220	10 x 220	297,766	TX40	50	50 -
• TEXBT10240	10 x 240	377,770	TX40	50	50 -

• Medidas sin homologar
• Hasta fin de existencias



Tirafondo de alto rendimiento

TEX

MADERA



CÓDIGO	MEDIDA	€/100		UD. MIN. VENTA		
• TEXZT30016	3 x 16	2,172	TX10	2.000	1.000	24.000
• TEXZT30020	3 x 20	2,251	TX10	2.000	1.000	24.000
TEXZT30025	3 x 25	2,887	TX10	2.000	1.000	24.000
TEXZT30030	3 x 30	3,329	TX10	2.000	1.000	12.000
TEXZT30035	3 x 35	3,382	TX10	2.000	1.000	12.000
TEXZT30040	3 x 40	3,802	TX10	2.000	1.000	6.000
• TEXZT35012	3,5 x 12	2,381	TX15	2.000	1.000	24.000
• TEXZT35016	3,5 x 16	2,506	TX15	2.000	1.000	24.000
• TEXZT35020	3,5 x 20	2,695	TX15	2.000	1.000	24.000
TEXZT35025	3,5 x 25	3,368	TX15	2.000	1.000	12.000
TEXZT35030	3,5 x 30	3,825	TX15	2.000	1.000	12.000
TEXZT35035	3,5 x 35	4,051	TX15	2.000	1.000	12.000
TEXZT35040	3,5 x 40	4,908	TX15	1.000	500	6.000
TEXZT35045	3,5 x 45	5,645	TX15	1.000	500	6.000
TEXZT35050	3,5 x 50	6,378	TX15	1.000	500	6.000
• TEXZT40016	4 x 16	2,787	TX20	2.000	1.000	24.000
• TEXZT40020	4 x 20	3,170	TX20	2.000	1.000	12.000
• TEXZT40025	4 x 25	3,518	TX20	2.000	1.000	12.000
TEXZT40030	4 x 30	4,013	TX20	2.000	1.000	6.000
TEXZT40035	4 x 35	4,851	TX20	1.000	500	6.000
TEXZT40040	4 x 40	5,267	TX20	1.000	500	6.000
TEXZT40045	4 x 45	6,566	TX20	1.000	500	6.000
TEXZT40050	4 x 50	6,599	TX20	1.000	500	6.000
TEXZT40055	4 x 55	7,520	TX20	500	250	3.000
TEXZT40060	4 x 60	8,657	TX20	500	250	3.000
TEXZT40070	4 x 70	10,182	TX20	500	250	1.500
• TEXZT45030	4,5 x 30	4,897	TX20	1.000	500	6.000
TEXZT45035	4,5 x 35	6,184	TX20	1.000	500	6.000
TEXZT45040	4,5 x 40	6,287	TX20	1.000	500	3.000
TEXZT45050	4,5 x 50	7,260	TX20	500	250	3.000
TEXZT45060	4,5 x 60	10,359	TX20	500	250	1.500
TEXZT45070	4,5 x 70	13,827	TX20	500	250	1.500

CÓDIGO	MEDIDA	€/100		UD. MIN. VENTA		
TEXZT45080	4,5 x 80	16,764	TX20	200	100	1.200
• TEXZT50030	5 x 30	7,083	TX25	1.000	500	6.000
TEXZT50035	5 x 35	7,603	TX25	1.000	500	6.000
TEXZT50040	5 x 40	8,097	TX25	1.000	500	6.000
TEXZT50045	5 x 45	9,415	TX25	500	250	3.000
TEXZT50050	5 x 50	10,163	TX25	500	250	3.000
TEXZT50060	5 x 60	12,773	TX25	500	250	2.000
TEXZT50070	5 x 70	14,747	TX25	400	200	1.200
TEXZT50080	5 x 80	19,350	TX25	200	100	1.200
TEXZT50090	5 x 90	19,110	TX25	200	100	1.200
TEXZT50100	5 x 100	25,097	TX25	200	100	1.200
• TEXZT60050	6 x 50	16,493	TX30	500	250	2.000
TEXZT60060	6 x 60	19,061	TX30	500	250	1.500
TEXZT60070	6 x 70	21,337	TX30	200	100	1.200
TEXZT60080	6 x 80	27,059	TX30	200	100	1.200
TEXZT60090	6 x 90	31,170	TX30	200	100	800
TEXZT60100	6 x 100	34,209	TX30	200	100	800
TEXZT60110	6 x 110	42,509	TX30	200	100	600
TEXZT60120	6 x 120	45,362	TX30	200	100	600
TEXZT60130	6 x 130	47,370	TX30	100	100	600
TEXZT60140	6 x 140	59,845	TX30	100	100	600
TEXZT60150	6 x 150	69,832	TX30	100	100	600
TEXZT60160	6 x 160	75,310	TX30	100	100	600
TEXZT60180	6 x 180	99,774	TX30	100	100	800
TEXZT60200	6 x 200	118,728	TX30	100	100	300
TEXZT60220	6 x 220	134,962	TX30	100	100	-
TEXZT60240	6 x 240	160,423	TX30	100	100	600
TEXZT60260	6 x 260	181,365	TX30	100	100	-
TEXZT60280	6 x 280	211,837	TX30	100	100	-
TEXZT60300	6 x 300	227,040	TX30	100	100	-

• Medidas sin homologar
• Hasta fin de existencias

TEX-ZT

Cincado. Huella TX



Disponible en varios recubrimientos. Consulte precio y plazo de entrega.

INOXIDABLE



CÓDIGO	MEDIDA	€/100			
TEXA250050	5 x 50	30,953	TX25	250	3.000
TEXA250060	5 x 60	37,197	TX25	100	2.400
TEXA250070	5 x 70	42,157	TX25	100	2.400

 Blíster

CÓDIGO	MEDIDA	€/BOLSA	PCS B	BOLSAS
BZTXA250050	5 x 50	2,459	4	20
BZTXA250060	5 x 60	2,459	4	20
BZTXA250070	5 x 70	2,459	2	20

 Caja ventana

CÓDIGO	MEDIDA	€/CAJA	PCS	CAJAS
VTEXA250050	5 x 50	7,967	20	8
VTEXA250060	5 x 60	9,570	20	8
VTEXA250070	5 x 70	10,853	20	8

TEX-A2

Inoxidable A2. Huella TX



INDEX

A PERFECT FIXING

Expositor

Tornillería para madera



BLISTER



CAJA CON VENTANA



CAJA PROFESIONAL

DIMENSIONES
Ancho: 100 cm
Alto: 240 cm



Tirafondo de alto rendimiento

TEX

MADERA



CÓDIGO	MEDIDA	€/100			
TECBT60080	6 x 80	33,960	TX30	200	1.200
TECBT60100	6 x 100	40,590	TX30	100	1.200
TECBT60120	6 x 120	60,353	TX30	100	600
TECBT60140	6 x 140	72,077	TX30	100	600
TECBT60160	6 x 160	98,763	TX30	100	400
TECBT60180	6 x 180	124,620	TX30	100	-
TECBT60200	6 x 200	160,620	TX30	100	-
TECBT80080	8 x 80	68,983	TX40	50	600
TECBT80100	8 x 100	71,447	TX40	50	300
TECBT80120	8 x 120	106,897	TX40	50	300
TECBT80140	8 x 140	114,350	TX40	50	300
TECBT80160	8 x 160	162,297	TX40	50	200
TECBT80180	8 x 180	168,960	TX40	50	-
TECBT80200	8 x 200	195,337	TX40	50	-
TECBT80220	8 x 220	223,657	TX40	50	-
TECBT80240	8 x 240	254,680	TX40	50	-

CÓDIGO	MEDIDA	€/100			
TECBT80260	8 x 260	298,270	TX40	50	-
TECBT80280	8 x 280	300,643	TX40	50	-
TECBT80300	8 x 300	342,307	TX40	50	-
TECBT10100	10 x 100	126,003	TX40	50	300
TECBT10120	10 x 120	157,950	TX40	50	300
TECBT10140	10 x 140	190,523	TX40	50	300
TECBT10160	10 x 160	222,493	TX40	50	200
TECBT10180	10 x 180	299,100	TX40	50	-
TECBT10200	10 x 200	336,020	TX40	25	-
TECBT10220	10 x 220	370,977	TX40	25	-
TECBT10240	10 x 240	409,250	TX40	25	-
TECBT10260	10 x 260	454,550	TX40	25	-
TECBT10280	10 x 280	509,987	TX40	25	-
TECBT10300	10 x 300	558,450	TX40	25	-

TEC-BT

Cabeza ancha bicromatado. Huella TX



MADERA



CÓDIGO	MEDIDA	€/100		
TEXABM06	Ø6	65,554	100	2.400
TEXABM08	Ø8	70,984	100	2.400
TEXABM10	Ø10	120,428	100	1.200

TEX-AB

Arandela cónica



INDEXwood VI

SOFTWARE DE DISEÑO PARA EL CÁLCULO DE ESTRUCTURAS DE MADERA

Permite realizar cálculos de fijaciones estructurales en madera con tirafondos, de acuerdo con el Eurocódigo 5 (norma EN 1995-1-1).



TEX

TIRAFONDO DE ALTAS PRESTACIONES PARA MADERA



CARACTERÍSTICAS TORNILLOS TEX • TABLA COMPARATIVA

TECBT	TEXBT	TEXBP	TEXZT	TEXZP	Ø	LONGITUD TORNILLO	LONGITUD ROSCA	LIMPIADOR	PUNTA ULTRA AFILADA	HUELLA
-	-	TEXBP25010	-	TEXZP25010	2,5	10	COMPLETA	-	-	PZ1
-	-	TEXBP25012	-	TEXZP25012		12				
-	-	TEXBP25016	-	TEXZP25016		16				
-	-	TEXBP25020	-	TEXZP25020		20				
-	-	TEXBP25025	-	TEXZP25025		25				
-	-	TEXBP30010	-	TEXZP30010	3	10	COMPLETA	-	-	PZ1
-	-	TEXBP30012	-	TEXZP30012		12				
-	-	TEXBP30015	-	TEXZP30015		15				
-	TEXBT30016	TEXBP30016	TEXZT30016	TEXZP30016		16				
-	TEXBT30020	TEXBP30020	TEXZT30020	TEXZP30020		20				
-	TEXBT30025	TEXBP30025	TEXZT30025	TEXZP30025		25				
-	TEXBT30030	TEXBP30030	TEXZT30030	TEXZP30030		30				
-	TEXBT30035	TEXBP30035	TEXZT30035	TEXZP30035		35				
-	TEXBT30040	TEXBP30040	TEXZT30040	TEXZP30040		40				
-	-	TEXBP30045	-	TEXZP30045		45				
-	-	TEXBP35010	-	TEXZP35010	3,5	10	COMPLETA	-	-	PZ2
-	TEXBT35012	TEXBP35012	TEXZT35012	TEXZP35012		12				
-	-	TEXBP35015	-	TEXZP35015		15				
-	TEXBT35016	TEXBP35016	TEXZT35016	TEXZP35016		16				
-	TEXBT35020	TEXBP35020	TEXZT35020	TEXZP35020		20				
-	TEXBT35025	TEXBP35025	TEXZT35025	TEXZP35025		25				
-	TEXBT35030	TEXBP35030	TEXZT35030	TEXZP35030		30				
-	TEXBT35035	TEXBP35035	TEXZT35035	TEXZP35035		35				
-	TEXBT35040	TEXBP35040	TEXZT35040	TEXZP35040		40				
-	TEXBT35045	TEXBP35045	TEXZT35045	TEXZP35045		45				
-	TEXBT35050	TEXBP35050	TEXZT35050	TEXZP35050	50					
-	-	TEXBP40012	-	TEXZP40012	4	12	COMPLETA	-	-	TX20 / PZ2
-	-	TEXBP40015	-	TEXZP40015		15				
-	TEXBT40016	TEXBP40016	TEXZT40016	TEXZP40016		16				
-	TEXBT40020	TEXBP40020	TEXZT40020	TEXZP40020		20				
-	TEXBT40025	TEXBP40025	TEXZT40025	TEXZP40025		25				
-	TEXBT40030	TEXBP40030	TEXZT40030	TEXZP40030		30				
-	TEXBT40035	TEXBP40035	TEXZT40035	TEXZP40035		35				
-	TEXBT40040	TEXBP40040	TEXZT40040	TEXZP40040		40				
-	TEXBT40045	TEXBP40045	TEXZT40045	TEXZP40045		45				
-	TEXBT40050	TEXBP40050	TEXZT40050	TEXZP40050		50				
-	TEXBT40055	TEXBP40055	TEXZT40055	TEXZP40055	55					
-	TEXBT40060	TEXBP40060	TEXZT40060	TEXZP40060	4,5	60	COMPLETA	-	-	T20 / PZ2
-	TEXBT40070	TEXBP40070	TEXZT40070	TEXZP40070		70				
-	-	TEXBP40080	-	TEXZP40080		80				
-	-	TEXBP45016	-	TEXZP45016		16				
-	-	TEXBP45020	-	TEXZP45020		20				
-	TEXBT45025	TEXBP45025	-	TEXZP45025		25				
-	TEXBT45030	TEXBP45030	TEXZT45030	TEXZP45030		30				
-	TEXBT45035	TEXBP45035	TEXZT45035	TEXZP45035		35				
-	TEXBT45040	TEXBP45040	TEXZT45040	TEXZP45040	40					
-	TEXBT45045	TEXBP45045	-	TEXZP45045	45					
-	TEXBT45050	TEXBP45050	TEXZT45050	TEXZP45050	50					
-	TEXBT45060	TEXBP45060	TEXZT45060	TEXZP45060	4,5	60	COMPLETA	-	-	T20 / PZ2
-	TEXBT45070	TEXBP45070	TEXZT45070	TEXZP45070		70				
-	TEXBT45080	TEXBP45080	TEXZT45080	TEXZP45080		80				

TECBT	TEXBT	TEXBP	TEXZT	TEXZP	Ø	LONGITUD TORNILLO	LONGITUD ROSCA	LIMPIADOR	PUNTA ULTRA AFILADA	HUELLA
-	-	TEXBP50025	-	TEXZP50025	5	25	COMPLETA	-	SI	TX25 / PZ2
-	TEXBT50030	TEXBP50030	TEXZT50030	TEXZP50030		30				
-	TEXBT50035	TEXBP50035	TEXZT50035	TEXZP50035		35				
-	TEXBT50040	TEXBP50040	TEXZT50040	TEXZP50040		40	30			
-	TEXBT50045	TEXBP50045	TEXZT50045	TEXZP50045		45				
-	TEXBT50050	TEXBP50050	TEXZT50050	TEXZP50050		50				
-	TEXBT50060	TEXBP50060	TEXZT50060	TEXZP50060		60	40			
-	TEXBT50070	TEXBP50070	TEXZT50070	TEXZP50070		70				
-	TEXBT50080	TEXBP50080	TEXZT50080	TEXZP50080		80				
-	TEXBT50090	TEXBP50090	TEXZT50090	TEXZP50090		90	70			
-	TEXBT50100	TEXBP50100	TEXZT50100	TEXZP50100		100				
-	-	TEXBP50110	-	TEXZP50110		110				
-	TEXBT50120	TEXBP50120	-	TEXZP50120	120	40				
-	TEXBT60040	TEXBP60040	-	TEXZP60040	40					
-	TEXBT60045	TEXBP60045	-	TEXZP60045	45		30			
-	TEXBT60050	TEXBP60050	TEXZT60050	TEXZP60050	50					
-	TEXBT60060	TEXBP60060	TEXZT60060	TEXZP60060	60					
-	TEXBT60070	TEXBP60070	TEXZT60070	TEXZP60070	70		40			
TECBT60080	TEXBT60080	TEXBP60080	TEXZT60080	TEXZP60080	80					
-	TEXBT60090	TEXBP60090	TEXZT60090	TEXZP60090	90					
TECBT60100	TEXBT60100	TEXBP60100	TEXZT60100	TEXZP60100	100		70			
-	TEXBT60110	TEXBP60110	TEXZT60110	TEXZP60110	110					
TECBT60120	TEXBT60120	TEXBP60120	TEXZT60120	TEXZP60120	120					
-	TEXBT60130	-	TEXZT60130	-	130			SI		
TECBT60140	TEXBT60140	-	TEXZT60140	-	140					
-	TEXBT60150	-	TEXZT60150	-	150					
TECBT60160	TEXBT60160	-	TEXZT60160	-	160	SI				
TECBT60180	TEXBT60180	-	TEXZT60180	-	180					
TECBT60200	TEXBT60200	-	TEXZT60200	-	200					
-	TEXBT60220	-	TEXZT60220	-	220	SI				
-	TEXBT60240	-	TEXZT60240	-	240					
-	TEXBT60260	-	TEXZT60260	-	260					
-	TEXBT60280	-	TEXZT60280	-	280	SI				
-	TEXBT60300	-	TEXZT60300	-	300					
TECBT80080	TEXBT80080	-	-	-	80					
TECBT80100	TEXBT80100	-	-	-	100	80				
TECBT80120	TEXBT80120	-	-	-	120					
TECBT80140	TEXBT80140	-	-	-	140					
TECBT80160	TEXBT80160	-	-	-	160					
TECBT80180	TEXBT80180	-	-	-	180					
TECBT80200	TEXBT80200	-	-	-	200					
TECBT80220	TEXBT80220	-	-	-	220					
TECBT80240	TEXBT80240	-	-	-	240		SI			
TECBT80260	TEXBT80260	-	-	-	260					
TECBT80280	TEXBT80280	-	-	-	280					
TECBT80300	TEXBT80300	-	-	-	300		SI			
-	TEXBT80320	-	-	-	320					
-	TEXBT80340	-	-	-	340					
-	TEXBT80360	-	-	-	360	SI				
-	TEXBT80380	-	-	-	380					
-	TEXBT80400	-	-	-	400					
-	TEXBT10080	-	-	-	80	80				
TECBT10100	TEXBT10100	-	-	-	100					
TECBT10120	TEXBT10120	-	-	-	120					
TECBT10140	TEXBT10140	-	-	-	140					
TECBT10160	TEXBT10160	-	-	-	160					
TECBT10180	TEXBT10180	-	-	-	180					
TECBT10200	TEXBT10200	-	-	-	200					
TECBT10220	TEXBT10220	-	-	-	220					
TECBT10240	TEXBT10240	-	-	-	240		SI			
TECBT10260	-	-	-	-	260					
TECBT10280	-	-	-	-	280					
TECBT10300	-	-	-	-	300		SI			
-	-	-	-	-	320					
-	-	-	-	-	340					
-	-	-	-	-	360	SI				
-	-	-	-	-	380					
-	-	-	-	-	400					
-	-	-	-	-	450					

TP-PO B

Bicromatado. Huella PZ

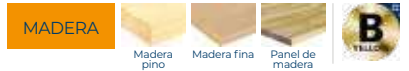

CÓDIGO	MEDIDA	€/100		LONGITUD DE LA ROSCA	UD. MIN. VENTA		
• TPP025010	2,5 x 10	1,165	PZ1	Total	2.000	1.000	45.000
• TPP025012	2,5 x 12	1,175	PZ1	Total	2.000	1.000	45.000
• TPP025016	2,5 x 16	1,317	PZ1	Total	2.000	1.000	45.000
TPP025020	2,5 x 20	1,473	PZ1	Total	2.000	1.000	24.000
TPP025025	2,5 x 25	1,609	PZ1	Total	2.000	1.000	24.000
• TPP030012	3 x 12	1,042	PZ1	Total	2.000	1.000	45.000
• TPP030016	3 x 16	1,153	PZ1	Total	2.000	1.000	24.000
• TPP030020	3 x 20	1,297	PZ1	Total	2.000	1.000	24.000
TPP030025	3 x 25	1,507	PZ1	Total	2.000	1.000	12.000
TPP030030	3 x 30	1,677	PZ1	Total	2.000	1.000	12.000
TPP030040	3 x 40	2,275	PZ1	Total	2.000	1.000	6.000
• TPP035016	3,5 x 16	1,297	PZ2	Total	2.000	1.000	24.000
• TPP035020	3,5 x 20	1,590	PZ2	Total	2.000	1.000	12.000
TPP035025	3,5 x 25	1,737	PZ2	Total	2.000	1.000	12.000
TPP035030	3,5 x 30	2,015	PZ2	Total	2.000	1.000	12.000
TPP035035	3,5 x 35	2,387	PZ2	Total	1.000	500	6.000
TPP035040	3,5 x 40	2,597	PZ2	Total	1.000	500	6.000
TPP035050	3,5 x 50	3,397	PZ2	Total	500	250	3.000
• TPP040016	4 x 16	1,653	PZ2	Total	2.000	1.000	16.000
• TPP040020	4 x 20	1,966	PZ2	Total	2.000	1.000	12.000
• TPP040025	4 x 25	2,170	PZ2	Total	2.000	1.000	12.000
TPP040030	4 x 30	2,577	PZ2	Total	1.000	500	6.000
TPP040035	4 x 35	2,907	PZ2	Total	1.000	500	6.000
TPP040040	4 x 40	3,040	PZ2	Total	1.000	500	6.000
TPP040045	4 x 45	3,830	PZ2	Total	1.000	500	3.000
TPP040050	4 x 50	4,230	PZ2	Total	500	250	3.000
TPP040060	4 x 60	4,850	PZ2	Total	500	250	3.000
TPP040070	4 x 70	5,977	PZ2	Parcial 52	500	250	3.000
• TPP045020	4,5 x 20	2,457	PZ2	Total	1.000	500	12.000
• TPP045025	4,5 x 25	2,917	PZ2	Total	1.000	500	6.000
• TPP045030	4,5 x 30	3,309	PZ2	Total	1.000	500	6.000
TPP045035	4,5 x 35	3,637	PZ2	Total	1.000	500	6.000
TPP045040	4,5 x 40	4,101	PZ2	Total	1.000	500	3.000
TPP045045	4,5 x 45	4,850	PZ2	Total	500	250	3.000
TPP045050	4,5 x 50	5,220	PZ2	Total	500	250	3.000
TPP045060	4,5 x 60	6,150	PZ2	Total	500	250	3.000
TPP045070	4,5 x 70	7,769	PZ2	Parcial 52	500	250	1.500
TPP045080	4,5 x 80	8,957	PZ2	Parcial 52	200	100	1.200
• TPP050020	5 x 20	3,027	PZ2	Total	1.000	500	6.000
• TPP050025	5 x 25	3,607	PZ2	Total	1.000	500	6.000
• TPP050030	5 x 30	4,077	PZ2	Total	500	250	6.000
TPP050035	5 x 35	4,807	PZ2	Total	500	250	3.000
TPP050040	5 x 40	5,277	PZ2	Total	500	250	3.000
TPP050045	5 x 45	5,750	PZ2	Total	500	250	3.000
TPP050050	5 x 50	6,163	PZ2	Total	500	250	3.000
TPP050060	5 x 60	7,413	PZ2	Total	500	250	1.500
TPP050070	5 x 70	9,270	PZ2	Parcial 52	200	100	1.200
TPP050080	5 x 80	10,470	PZ2	Parcial 52	200	100	1.200
TPP050090	5 x 90	12,563	PZ2	Parcial 60	200	100	1.200
TPP050100	5 x 100	13,427	PZ2	Parcial 60	200	100	1.200
TPP050120	5 x 120	19,953	PZ2	Parcial 75	200	100	1.200
• TPP060040	6 x 40	7,640	PZ3	Total	500	250	3.000
TPP060050	6 x 50	8,807	PZ3	Total	500	250	1.500
TPP060060	6 x 60	10,250	PZ3	Total	500	250	1.500
TPP060070	6 x 70	13,582	PZ3	Parcial 52	200	100	1.200
TPP060080	6 x 80	15,077	PZ3	Parcial 52	200	100	1.200
TPP060090	6 x 90	16,741	PZ3	Parcial 60	200	100	1.200
TPP060100	6 x 100	19,527	PZ3	Parcial 60	100	100	1.200
TPP060110	6 x 110	22,857	PZ3	Parcial 70	100	100	600
TPP060120	6 x 120	24,307	PZ3	Parcial 70/75	100	100	600
TPP060130	6 x 130	28,800	PZ3	Parcial 70/75	100	100	600
TPP060140	6 x 140	32,080	PZ3	Parcial 70/75	100	100	600
TPP060150	6 x 150	35,463	PZ3	Parcial 70/75	100	100	600
TPP060160	6 x 160	38,647	PZ3	Parcial 70/75	100	100	400
TPP060180	6 x 180	54,510	PZ3	Parcial 70/75	100	100	300
TPP060200	6 x 200	70,967	PZ3	Parcial 70/75	100	100	300
TPP060220	6 x 220	110,490	PZ3	Parcial 70/75	100	100	300

• Medidas sin homologar



Tirafondos de cabeza avellanada

TP

Blíster

CÓDIGO	MEDIDA	€/BOLSA	PCS	BOLSAS
BZTPPO25016	2,5 x 16	1,943	40	20
BZTPPO25020	2,5 x 20	1,943	40	20
BZTPPO25025	2,5 x 25	1,943	40	20
BZTPPO30016	3 x 16	1,943	40	20
BZTPPO30020	3 x 20	1,943	40	20
BZTPPO30025	3 x 25	1,943	40	20
BZTPPO30030	3 x 30	1,943	40	20
BZTPPO35016	3,5 x 16	1,943	40	20
BZTPPO35020	3,5 x 20	1,943	40	20
BZTPPO35025	3,5 x 25	1,943	40	20
BZTPPO35030	3,5 x 30	1,943	40	20
BZTPPO35035	3,5 x 35	1,943	20	20
BZTPPO35040	3,5 x 40	1,943	20	20
BZTPPO35050	3,5 x 50	1,943	20	20
BZTPPO40016	4 x 16	1,943	40	20
BZTPPO40020	4 x 20	1,943	40	20
BZTPPO40025	4 x 25	1,943	40	20
BZTPPO40030	4 x 30	1,943	20	20
BZTPPO40035	4 x 35	1,943	20	20
BZTPPO40040	4 x 40	1,943	20	20
BZTPPO40045	4 x 45	1,943	20	20
BZTPPO40050	4 x 50	1,943	10	20
BZTPPO40060	4 x 60	1,943	10	20
BZTPPO45030	4,5 x 30	1,943	20	20
BZTPPO45035	4,5 x 35	1,943	20	20
BZTPPO45040	4,5 x 40	1,943	20	20
BZTPPO45045	4,5 x 45	1,943	10	20
BZTPPO45050	4,5 x 50	1,943	10	20
BZTPPO45060	4,5 x 60	1,943	10	20
BZTPPO45070	4,5 x 70	1,943	10	20
BZTPPO50030	5 x 30	1,943	10	20
BZTPPO50035	5 x 35	1,943	10	20
BZTPPO50040	5 x 40	1,943	10	20
BZTPPO50050	5 x 50	1,943	10	20
BZTPPO50060	5 x 60	1,943	10	20
BZTPPO50070	5 x 70	1,943	4	20
BZTPPO50080	5 x 80	1,943	4	20
BZTPPO50100	5 x 100	1,943	4	20
BZTPPO60040	6 x 40	1,943	10	20
BZTPPO60050	6 x 50	1,943	10	20
BZTPPO60060	6 x 60	1,943	10	20
BZTPPO60070	6 x 70	1,943	4	20
BZTPPO60080	6 x 80	1,943	4	20
BZTPPO60090	6 x 90	1,943	4	20
BZTPPO60100	6 x 100	1,943	4	20

Caja ventana

CÓDIGO	MEDIDA	€/CAJA	PCS	CAJAS
VTPPO30016	3 x 16	3,858	250	8
VTPPO30020	3 x 20	4,308	250	8
VTPPO30025	3 x 25	4,904	250	8
VTPPO30030	3 x 30	5,363	250	8
VTPPO30040	3 x 40	6,582	250	8
VTPPO35016	3,5 x 16	4,426	250	8
VTPPO35020	3,5 x 20	4,818	250	8
VTPPO35025	3,5 x 25	5,493	250	8
VTPPO35030	3,5 x 30	5,889	250	8
VTPPO35035	3,5 x 35	4,667	150	8
VTPPO35040	3,5 x 40	4,848	150	8
VTPPO35050	3,5 x 50	4,379	100	8
VTPPO40016	4 x 16	5,221	250	8
VTPPO40020	4 x 20	5,977	250	8
VTPPO40025	4 x 25	6,606	250	8
VTPPO40030	4 x 30	5,404	175	8
VTPPO40035	4 x 35	5,226	150	8
VTPPO40040	4 x 40	5,625	150	8
VTPPO40045	4 x 45	6,868	150	8
VTPPO40050	4 x 50	5,168	100	8
VTPPO40060	4 x 60	6,029	100	8
VTPPO45030	4,5 x 30	6,047	150	8
VTPPO45035	4,5 x 35	6,626	150	8
VTPPO45040	4,5 x 40	7,126	150	8
VTPPO45045	4,5 x 45	5,387	90	8
VTPPO45050	4,5 x 50	6,428	100	8
VTPPO45060	4,5 x 60	6,012	80	8
VTPPO45070	4,5 x 70	5,445	60	8
VTPPO50030	5 x 30	5,066	100	8
VTPPO50035	5 x 35	5,514	100	8
VTPPO50040	5 x 40	6,047	100	8
VTPPO50050	5 x 50	7,243	100	8
VTPPO50060	5 x 60	7,182	80	8
VTPPO50070	5 x 70	4,255	35	8
VTPPO50080	5 x 80	3,981	30	8
VTPPO50090	5 x 90	4,454	30	8
VTPPO60040	6 x 40	8,975	100	8
VTPPO60050	6 x 50	8,034	80	8
VTPPO60060	6 x 60	7,156	60	8
VTPPO60070	6 x 70	4,642	30	8
VTPPO60080	6 x 80	5,154	30	8

TP-PO B

Bicromatado. Huella PZ



TP-PO Z

Cincado. Huella PZ



Disponible en varios recubrimientos. Consulte precio y plazo de entrega.

CÓDIGO	MEDIDA	€/100		LONGITUD DE LA ROSCA	UD. MIN. VENTA		
• TPPOZ25010	2,5 x 10	1,165	PZ1	Total	2.000	1.000	45.000
• TPPOZ25012	2,5 x 12	1,175	PZ1	Total	2.000	1.000	45.000
• TPPOZ25016	2,5 x 16	1,317	PZ1	Total	2.000	1.000	45.000
TPPOZ25020	2,5 x 20	1,473	PZ1	Total	2.000	1.000	24.000
TPPOZ25025	2,5 x 25	1,609	PZ1	Total	2.000	1.000	24.000
• TPPOZ30012	3 x 12	1,042	PZ1	Total	2.000	1.000	45.000
• TPPOZ30016	3 x 16	1,153	PZ1	Total	2.000	1.000	24.000
• TPPOZ30020	3 x 20	1,297	PZ1	Total	2.000	1.000	24.000
TPPOZ30025	3 x 25	1,507	PZ1	Total	2.000	1.000	12.000
TPPOZ30030	3 x 30	1,677	PZ1	Total	2.000	1.000	12.000
TPPOZ30040	3 x 40	2,275	PZ1	Total	2.000	1.000	6.000
• TPPOZ35016	3,5 x 16	1,297	PZ2	Total	2.000	1.000	24.000
• TPPOZ35020	3,5 x 20	1,590	PZ2	Total	2.000	1.000	12.000
TPPOZ35025	3,5 x 25	1,737	PZ2	Total	2.000	1.000	12.000
TPPOZ35030	3,5 x 30	2,015	PZ2	Total	2.000	1.000	12.000
TPPOZ35035	3,5 x 35	2,387	PZ2	Total	1.000	500	6.000
TPPOZ35040	3,5 x 40	2,597	PZ2	Total	1.000	500	6.000
TPPOZ35050	3,5 x 50	3,397	PZ2	Total	500	250	3.000
• TPPOZ40016	4 x 16	1,653	PZ2	Total	2.000	1.000	16.000
• TPPOZ40020	4 x 20	1,966	PZ2	Total	2.000	1.000	12.000
• TPPOZ40025	4 x 25	2,170	PZ2	Total	2.000	1.000	12.000
TPPOZ40030	4 x 30	2,577	PZ2	Total	1.000	500	6.000
TPPOZ40035	4 x 35	2,907	PZ2	Total	1.000	500	6.000
TPPOZ40040	4 x 40	3,040	PZ2	Total	1.000	500	6.000
TPPOZ40045	4 x 45	3,830	PZ2	Total	1.000	500	3.000
TPPOZ40050	4 x 50	4,230	PZ2	Total	500	250	3.000
TPPOZ40060	4 x 60	4,850	PZ2	Total	500	250	3.000
TPPOZ40070	4 x 70	5,977	PZ2	Parcial 52	500	250	1.500
• TPPOZ45020	4,5 x 20	2,457	PZ2	Total	1.000	500	12.000
• TPPOZ45025	4,5 x 25	2,917	PZ2	Total	1.000	500	6.000
• TPPOZ45030	4,5 x 30	3,309	PZ2	Total	1.000	500	6.000
TPPOZ45035	4,5 x 35	3,637	PZ2	Total	1.000	500	6.000
TPPOZ45040	4,5 x 40	4,101	PZ2	Total	1.000	500	3.000
TPPOZ45045	4,5 x 45	4,850	PZ2	Total	500	250	3.000
TPPOZ45050	4,5 x 50	5,220	PZ2	Total	500	250	3.000
TPPOZ45060	4,5 x 60	6,150	PZ2	Total	500	250	3.000
TPPOZ45070	4,5 x 70	7,769	PZ2	Parcial 52	500	250	1.500
TPPOZ45080	4,5 x 80	8,957	PZ2	Parcial 52	200	100	1.200
• TPPOZ50020	5 x 20	3,027	PZ2	Total	1.000	500	6.000
• TPPOZ50025	5 x 25	3,607	PZ2	Total	1.000	500	6.000
• TPPOZ50030	5 x 30	4,077	PZ2	Total	500	250	6.000
TPPOZ50035	5 x 35	4,807	PZ2	Total	500	250	3.000
TPPOZ50040	5 x 40	5,277	PZ2	Total	500	250	3.000
TPPOZ50045	5 x 45	5,750	PZ2	Total	500	250	3.000
TPPOZ50050	5 x 50	6,163	PZ2	Total	500	250	3.000
TPPOZ50060	5 x 60	7,413	PZ2	Total	500	250	1.500
TPPOZ50070	5 x 70	9,270	PZ2	Parcial 52	200	100	1.200
TPPOZ50080	5 x 80	10,470	PZ2	Parcial 52	200	100	1.200
TPPOZ50090	5 x 90	12,563	PZ2	Parcial 60	200	100	1.200
TPPOZ50100	5 x 100	13,427	PZ2	Parcial 60	200	100	1.200
TPPOZ50120	5 x 120	19,953	PZ2	Parcial 75	200	100	1.200
• TPPOZ60040	6 x 40	7,640	PZ3	Total	500	250	3.000
TPPOZ60050	6 x 50	8,807	PZ3	Total	500	250	1.500
TPPOZ60060	6 x 60	10,250	PZ3	Total	500	250	1.500
TPPOZ60070	6 x 70	13,582	PZ3	Parcial 52	200	100	1.200
TPPOZ60080	6 x 80	15,077	PZ3	Parcial 52	200	100	1.200
TPPOZ60090	6 x 90	16,741	PZ3	Parcial 60	200	100	1.200
TPPOZ60100	6 x 100	19,527	PZ3	Parcial 60	100	100	1.200
TPPOZ60110	6 x 110	22,857	PZ3	Parcial 70	100	100	600

• Medidas sin homologar

Tirafondos de cabeza avellanada

TP

TP-PO Z

Cincado. Huella PZ

 Caja ventana

CÓDIGO	MEDIDA	€/CAJA	PCS	CAJAS
VTPOZ30025	3 x 25	4,904	250	8
VTPOZ30030	3 x 30	5,363	250	8
VTPOZ35016	3,5 x 16	4,426	250	8
VTPOZ35020	3,5 x 20	4,818	250	8
VTPOZ35025	3,5 x 25	5,493	250	8
VTPOZ35030	3,5 x 30	5,889	250	8
VTPOZ35035	3,5 x 35	4,667	150	8
VTPOZ35040	3,5 x 40	4,848	150	8
VTPOZ35050	3,5 x 50	4,379	100	8
VTPOZ40016	4 x 16	5,221	250	8
VTPOZ40020	4 x 20	5,977	250	8
VTPOZ40025	4 x 25	6,606	250	8
VTPOZ40030	4 x 30	5,404	175	8
VTPOZ40035	4 x 35	5,226	150	8
VTPOZ40040	4 x 40	5,625	150	8
VTPOZ40045	4 x 45	6,868	150	8
VTPOZ40050	4 x 50	5,168	100	8
VTPOZ40060	4 x 60	6,029	100	8
VTPOZ45030	4,5 x 30	6,047	150	8
VTPOZ45035	4,5 x 35	6,626	150	8
VTPOZ45040	4,5 x 40	7,126	150	8
VTPOZ45045	4,5 x 45	5,387	90	8
VTPOZ45050	4,5 x 50	6,428	100	8
VTPOZ45060	4,5 x 60	6,012	80	8
VTPOZ45070	4,5 x 70	5,445	60	8
VTPOZ50030	5 x 30	5,066	100	8
VTPOZ50035	5 x 35	5,514	100	8
VTPOZ50040	5 x 40	6,047	100	8
VTPOZ50050	5 x 50	7,243	100	8
VTPOZ50060	5 x 60	7,182	80	8
VTPOZ50070	5 x 70	4,255	35	8
VTPOZ50080	5 x 80	3,981	30	8
VTPOZ50090	5 x 90	4,454	30	8
VTPOZ60060	6 x 60	7,156	60	8
VTPOZ60070	6 x 70	4,642	30	8
VTPOZ60080	6 x 80	5,154	30	8



Disponible en varios recubrimientos. Consulte precio y plazo de entrega.

TP-TO

Bicromatado. Huella TX

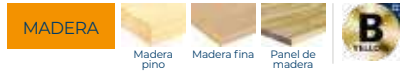

Disponible en varios recubrimientos. Consulte precio y plazo de entrega.

CÓDIGO	MEDIDA	€/100	UD. MIN. VENTA	UD. MIN. VENTA	UD. MIN. VENTA
TPTO30025	3 x 25	1,883	TX10	2.000	1.000 12.000
TPTO30030	3 x 30	1,983	TX10	2.000	1.000 12.000
• TPTO35015	3,5 x 15	1,632	TX15	2.000	1.000 24.000
• TPTO35017	3,5 x 17	1,635	TX15	2.000	1.000 24.000
• TPTO35020	3,5 x 20	1,898	TX15	2.000	1.000 12.000
TPTO35025	3,5 x 25	1,990	TX15	2.000	1.000 12.000
TPTO35030	3,5 x 30	2,280	TX15	2.000	1.000 12.000
TPTO35040	3,5 x 40	3,160	TX15	1.000	500 6.000
TPTO35050	3,5 x 50	3,653	TX15	1.000	500 3.000
• TPTO40020	4 x 20	2,427	TX20	2.000	1.000 12.000
• TPTO40025	4 x 25	2,807	TX20	2.000	1.000 12.000
TPTO40030	4 x 30	3,303	TX20	1.000	500 6.000
TPTO40035	4 x 35	3,760	TX20	1.000	500 6.000
TPTO40040	4 x 40	4,027	TX20	1.000	500 6.000
TPTO40045	4 x 45	4,577	TX20	1.000	500 6.000
TPTO40050	4 x 50	5,377	TX20	500	250 3.000
TPTO40060	4 x 60	5,650	TX20	500	250 3.000
TPTO40070	4 x 70	7,393	TX20	500	250 1.500
• TPTO45030	4,5 x 30	3,793	TX20	1.000	500 6.000
TPTO45035	4,5 x 35	4,433	TX20	1.000	500 6.000
TPTO45040	4,5 x 40	4,845	TX20	1.000	500 6.000
TPTO45045	4,5 x 45	6,003	TX20	500	250 3.000
TPTO45050	4,5 x 50	6,557	TX20	500	250 3.000
TPTO45060	4,5 x 60	7,527	TX20	500	250 3.000
TPTO45070	4,5 x 70	8,847	TX20	500	250 1.500
• TPTO50030	5 x 30	5,127	TX25	500	250 6.000

CÓDIGO	MEDIDA	€/100	UD. MIN. VENTA	UD. MIN. VENTA	UD. MIN. VENTA
TPTO50035	5 x 35	5,725	TX25	500	250 6.000
TPTO50040	5 x 40	6,318	TX25	500	250 3.000
TPTO50045	5 x 45	7,120	TX25	500	250 3.000
TPTO50050	5 x 50	7,620	TX25	500	250 3.000
TPTO50060	5 x 60	8,942	TX25	500	250 1.500
TPTO50070	5 x 70	11,387	TX25	200	100 1.200
TPTO50080	5 x 80	13,160	TX25	200	100 1.200
TPTO50090	5 x 90	14,380	TX25	200	100 1.200
TPTO50100	5 x 100	15,600	TX25	200	100 1.200
TPTO50120	5 x 120	21,600	TX25	200	100 1.200
TPTO60060	6 x 60	12,441	TX30	500	250 1.500
TPTO60070	6 x 70	14,876	TX30	200	100 1.200
TPTO60080	6 x 80	17,937	TX30	200	100 1.200
TPTO60090	6 x 90	21,090	TX30	200	100 1.200
TPTO60100	6 x 100	23,637	TX30	100	100 1.200
TPTO60110	6 x 110	26,460	TX30	100	100 600
TPTO60120	6 x 120	29,007	TX30	100	100 600
TPTO60130	6 x 130	33,917	TX30	100	100 600
TPTO60140	6 x 140	38,357	TX30	100	100 600
TPTO60150	6 x 150	43,297	TX30	100	100 600
TPTO60160	6 x 160	48,973	TX30	100	100 400
TPTO60180	6 x 180	65,623	TX30	100	100 300
TPTO60200	6 x 200	78,770	TX30	100	100 300
TPTO60220	6 x 220	116,947	TX30	100	100 300

• Medidas sin homologar

Caja ventana

CÓDIGO	MEDIDA	€/CAJA	PCS	CAJAS
VTPTO30025	3 x 25	5,680	250	8
VTPTO30030	3 x 30	6,212	250	8
VTPTO35015	3,5 x 15	5,292	250	8
VTPTO35020	3,5 x 20	6,020	250	8
VTPTO35025	3,5 x 25	6,501	250	8
VTPTO35030	3,5 x 30	7,239	250	8
VTPTO35040	3,5 x 40	6,009	150	8
VTPTO35050	3,5 x 50	5,209	100	8
VTPTO40020	4 x 20	7,402	250	8
VTPTO40025	4 x 25	8,804	250	8
VTPTO40030	4 x 30	7,361	175	8
VTPTO40035	4 x 35	7,013	150	8
VTPTO40040	4 x 40	7,583	150	8
VTPTO40045	4 x 45	8,528	150	8
VTPTO40050	4 x 50	6,673	100	8
VTPTO40060	4 x 60	7,238	100	8
VTPTO45030	4,5 x 30	7,286	150	8
VTPTO45035	4,5 x 35	8,044	150	8
VTPTO45040	4,5 x 40	9,291	150	8
VTPTO45045	4,5 x 45	6,529	90	8
VTPTO45050	4,5 x 50	8,145	100	8
VTPTO45060	4,5 x 60	7,479	80	8
VTPTO45070	4,5 x 70	6,595	60	8
VTPTO50030	5 x 30	6,377	100	8
VTPTO50035	5 x 35	7,133	100	8
VTPTO50040	5 x 40	8,395	100	8
VTPTO50050	5 x 50	9,478	100	8
VTPTO50060	5 x 60	8,695	80	8
VTPTO50070	5 x 70	5,307	35	8
VTPTO50080	5 x 80	5,146	30	8
VTPTO50090	5 x 90	5,626	30	8
VTPTO60060	6 x 60	9,077	60	8
VTPTO60070	6 x 70	5,694	30	8
VTPTO60080	6 x 80	6,866	30	8



Tirafondos de cabeza avellanada

TP

INOXIDABLE



TP-A2

Inoxidable A2. Huella PZ

CÓDIGO	MEDIDA	€/100			
TPA230016	3 x 16	4,810	PZ1	200	9.000
TPA230025	3 x 25	6,150	PZ1	200	9.000
TPA235020	3,5 x 20	8,290	PZ2	200	9.000
TPA235025	3,5 x 25	8,957	PZ2	200	9.000
TPA235030	3,5 x 30	10,920	PZ2	200	9.000
TPA235040	3,5 x 40	15,527	PZ2	200	4.800
TPA240030	4 x 30	13,273	PZ2	200	4.800
TPA240040	4 x 40	15,673	PZ2	200	4.800
TPA240050	4 x 50	24,597	PZ2	200	4.800
TPA245030	4,5 x 30	15,587	PZ2	200	4.800
TPA245050	4,5 x 50	24,897	PZ2	200	2.400
TPA250050	5 x 50	31,400	PZ2	200	2.400
TPA250070	5 x 70	42,793	PZ2	200	2.400



Tirafondo de cabeza alomada, bicromatado. Huella PZ

TR-PO

MADERA



CÓDIGO	MEDIDA	€/100			
TRPO30016	3 x 16	1,887	PZ1	1.000	24.000
TRPO30020	3 x 20	1,937	PZ1	1.000	12.000
TRPO35016	3,5 x 16	2,180	PZ2	1.000	24.000
TRPO35020	3,5 x 20	2,733	PZ2	1.000	12.000
TRPO35025	3,5 x 25	2,797	PZ2	1.000	12.000
TRPO35030	3,5 x 30	3,087	PZ2	1.000	12.000
TRPO35035	3,5 x 35	3,240	PZ2	500	6.000
TRPO40016	4 x 16	3,003	PZ2	1.000	12.000
TRPO40020	4 x 20	3,143	PZ2	1.000	12.000
TRPO40025	4 x 25	3,507	PZ2	1.000	12.000
TRPO40030	4 x 30	3,943	PZ2	500	6.000
TRPO40035	4 x 35	4,197	PZ2	500	6.000
TRPO40040	4 x 40	4,847	PZ2	500	6.000
TRPO40050	4 x 50	6,287	PZ2	250	3.000
TRPO45016	4,5 x 16	3,867	PZ2	500	12.000
TRPO45020	4,5 x 20	4,020	PZ2	500	8.000
TRPO45025	4,5 x 25	4,757	PZ2	500	6.000
TRPO45030	4,5 x 30	5,333	PZ2	500	6.000
TRPO45035	4,5 x 35	6,160	PZ2	500	6.000
TRPO45040	4,5 x 40	6,223	PZ2	500	3.000
TRPO45045	4,5 x 45	7,117	PZ2	250	3.000
TRPO50020	5 x 20	5,380	PZ2	500	6.000
TRPO50030	5 x 30	6,253	PZ2	250	6.000
TRPO50040	5 x 40	7,297	PZ2	250	3.000
TRPO50050	5 x 50	9,213	PZ2	250	3.000



DIN-571

Tornillo con rosca para madera y aglomerado. Cabeza hexagonal

DIN-571

Cincado

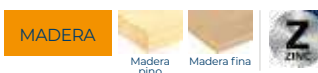

Disponible en varios recubrimientos. Consulte precio y plazo de entrega.

CÓDIGO	MEDIDA	€/100				CÓDIGO	MEDIDA	€/100			
• TB05030	5 x 30	5,007	8	200	4.800	TB08140	8 x 140	43,452	13	100	400
• TB05040	5 x 40	6,630	8	200	2.400	TB08150	8 x 150	45,755	13	100	400
TB05050	5 x 50	7,470	8	200	2.400	TB08160	8 x 160	47,769	13	100	400
TB05060	5 x 60	8,820	8	200	2.400	TB08180	8 x 180	61,511	13	100	300
• TB06025	6 x 25	5,907	10	200	2.400	TB08200	8 x 200	65,976	13	100	300
• TB06030	6 x 30	6,569	10	200	2.400	• TB10040	10 x 40	27,950	17	100	600
• TB06035	6 x 35	7,529	10	200	2.400	• TB10050	10 x 50	30,397	17	100	600
• TB06040	6 x 40	7,740	10	200	2.400	• TB10060	10 x 60	33,151	17	100	600
• TB06045	6 x 45	8,670	10	200	2.400	• TB10070	10 x 70	37,383	17	100	600
• TB06050	6 x 50	9,263	10	200	2.400	• TB10080	10 x 80	42,096	17	100	400
TB06060	6 x 60	10,920	10	200	1.200	• TB10090	10 x 90	49,791	17	100	400
TB06070	6 x 70	12,567	10	200	1.200	TB10100	10 x 100	48,413	17	100	400
TB06080	6 x 80	14,363	10	200	1.200	TB10110	10 x 110	53,378	17	50	300
TB06090	6 x 90	16,567	10	100	1.200	TB10120	10 x 120	58,390	17	50	300
TB06100	6 x 100	18,538	10	100	1.200	TB10130	10 x 130	65,646	17	50	300
TB06110	6 x 110	22,393	10	100	1.200	TB10140	10 x 140	73,420	17	50	200
TB06120	6 x 120	22,457	10	100	800	TB10150	10 x 150	82,138	17	50	200
TB07030	7 x 30	10,896	12	200	2.400	TB10160	10 x 160	87,679	17	50	200
TB07040	7 x 40	13,282	12	200	1.600	TB10180	10 x 180	98,185	17	50	150
TB07050	7 x 50	14,440	12	200	1.200	TB10200	10 x 200	105,708	17	50	150
TB07060	7 x 60	16,840	12	100	1.200	• TB12060	12 x 60	51,883	19	50	300
TB07070	7 x 70	20,355	12	100	1.200	• TB12070	12 x 70	57,090	19	50	300
TB07080	7 x 80	21,997	12	100	800	• TB12080	12 x 80	62,240	19	50	300
TB07090	7 x 90	22,371	12	100	400	• TB12090	12 x 90	66,327	19	50	300
TB07100	7 x 100	25,291	12	100	600	• TB12100	12 x 100	73,733	19	50	300
TB07120	7 x 120	30,921	12	100	600	TB12120	12 x 120	89,637	19	50	200
• TB08030	8 x 30	12,622	13	200	1.200	TB12130	12 x 130	96,287	19	50	100
• TB08040	8 x 40	15,230	13	200	1.200	TB12140	12 x 140	103,603	19	50	100
• TB08045	8 x 45	16,026	13	200	1.200	TB12150	12 x 150	107,283	19	50	200
• TB08050	8 x 50	16,453	13	200	1.200	TB12160	12 x 160	119,848	19	50	200
• TB08060	8 x 60	18,783	13	200	1.200	TB12180	12 x 180	137,397	19	50	150
• TB08070	8 x 70	21,357	13	200	800	TB12200	12 x 200	156,487	19	50	150
TB08080	8 x 80	23,833	13	200	800	• TB12220	12 x 220	178,465	19	50	100
TB08090	8 x 90	29,182	13	100	600	TB12240	12 x 240	191,409	19	50	100
TB08100	8 x 100	31,556	13	100	600	TB12260	12 x 260	209,837	19	50	100
TB08110	8 x 110	33,911	13	100	600	• TB14100	14 x 100	137,810	22	50	200
TB08120	8 x 120	35,558	13	100	600						
TB08130	8 x 130	40,946	13	100	400						

• Medidas sin homologar

Blíster

CÓDIGO	MEDIDA	€/BOLSA	PCS	BOLSAS
BZTB05030	5 x 30	1,943	4	20
BZTB05040	5 x 40	1,943	4	20
BZTB05050	5 x 50	1,943	4	20
BZTB06030	6 x 30	1,943	4	20
BZTB06040	6 x 40	1,943	4	20
BZTB06050	6 x 50	1,943	4	20
BZTB06060	6 x 60	1,943	4	20
BZTB06070	6 x 70	1,943	4	20
BZTB06080	6 x 80	1,943	4	20
BZTB07050	7 x 50	1,943	4	20
BZTB07060	7 x 60	1,943	4	20
BZTB07070	7 x 70	1,943	4	20
BZTB08040	8 x 40	1,943	4	20
BZTB08050	8 x 50	1,943	4	20
BZTB08060	8 x 60	1,943	4	20
BZTB08070	8 x 70	1,943	4	20
BZTB08080	8 x 80	1,943	4	15
BZTB08090	8 x 90	1,943	2	15
BZTB08100	8 x 100	1,943	2	15
BZTB10050	10 x 50	1,943	2	15
BZTB10060	10 x 60	1,943	2	15
BZTB10080	10 x 80	1,943	2	15

Caja ventana

CÓDIGO	MEDIDA	€/CAJA	PCS	CAJAS
VTB05040	5 x 40	4,315	50	8
VTB05050	5 x 50	5,072	50	8
VTB06040	6 x 40	5,090	50	8
VTB06050	6 x 50	4,775	40	8
VTB06060	6 x 60	4,181	30	8
VTB07050	7 x 50	4,681	25	8
VTB07060	7 x 60	4,455	20	8
VTB07070	7 x 70	5,121	20	8
VTB07080	7 x 80	5,412	20	8
VTB08050	8 x 50	4,280	20	8
VTB08060	8 x 60	4,891	20	8
VTB08070	8 x 70	5,556	20	8
VTB08080	8 x 80	4,650	15	8
VTB08090	8 x 90	3,979	10	8
VTB08100	8 x 100	3,936	10	8
VTB10070	10 x 70	4,789	10	8
VTB10080	10 x 80	5,079	10	8
VTB10090	10 x 90	5,887	10	8
VTB10100	10 x 100	6,199	10	8



Tornillo con rosca para madera y aglomerado. Cabeza hexagonal

DIN-571

INOXIDABLE



CÓDIGO	MEDIDA	€/100			
• TBA206040	6 x 40	32,353	10	100	2.400
• TBA206050	6 x 50	39,317	10	100	1.200
• TBA206060	6 x 60	47,063	10	100	1.200
• TBA206070	6 x 70	50,543	10	100	1.200
• TBA208050	8 x 50	73,330	13	100	1.200
• TBA208060	8 x 60	84,123	13	100	1.200
• TBA208070	8 x 70	97,087	13	100	600
• TBA208080	8 x 80	103,980	13	100	600
• TBA210080	10 x 80	181,847	17	100	400

• Medidas sin homologar

DIN-571 A2

Inoxidable A2



MADERA



CÓDIGO	MEDIDA	€/100			
TBR06050	6 x 50	9,263	10	200	1.200
TBR06060	6 x 60	10,920	10	200	1.200
TBR06070	6 x 70	12,567	10	200	1.200
TBR08050	8 x 50	16,453	13	200	1.200
TBR08060	8 x 60	18,783	13	200	800
TBR08070	8 x 70	21,357	13	200	800
TBR08080	8 x 80	23,833	13	200	800
TBR10060	10 x 60	33,151	17	100	600
TBR10080	10 x 80	42,096	17	100	400

571 TR

Con rosca completa



Tornillo inviolable. Huella TX

INV

MADERA



CÓDIGO	MEDIDA	€/100		UD. MIN. VENTA		
• INVZ6040	6 x 40	26,511	TX40	200	100	1.200
• INVZ6050	6 x 50	28,636	TX40	200	100	1.200
• INVZ6060	6 x 60	30,150	TX40	200	100	600
• INVZ6070	6 x 70	34,837	TX40	200	100	600
• INVZ7030	7 x 30	24,124	TX40	200	100	1.200
• INVZ7040	7 x 40	24,848	TX40	200	100	1.200
• INVZ7050	7 x 50	25,990	TX40	200	100	1.200
• INVZ7060	7 x 60	29,418	TX40	200	100	600
• INVZ7070	7 x 70	30,105	TX40	200	100	600
• INVZ7080	7 x 80	36,613	TX40	200	100	600
• INVZ7090	7 x 90	42,155	TX40	200	100	600
• INVZ7165	NEW 7 x 165	99,609	TX40	200	100	300
• INVZ7140	NEW 7 x 140	77,073	TX40	200	100	600
• INVZ7105	NEW 7 x 105	56,729	TX40	200	100	600
• INVZ7205	NEW 7 x 205	145,148	TX40	200	100	300
• INVZ7120	NEW 7 x 120	65,491	TX40	200	100	600

• Medidas sin homologar

INV Z

Cincado



Disponible en varios recubrimientos. Consulte precio y plazo de entrega.

Blíster

CÓDIGO	MEDIDA	€/BOLSA	PCS	BOLSAS
BZINVZ7060	7 x 60	2,459	4	20
BZINVZ7070	7 x 70	2,459	4	20
BZINVZ7080	7 x 80	2,459	4	15

Caja ventana

CÓDIGO	MEDIDA	€/CAJA	PCS	CAJAS
VINVZ7060	7 x 60	6,095	15	8
VINVZ7070	7 x 70	6,176	15	8

INV

Tornillo inviolable. Huella TX

INV A2

Inoxidable A2

INOXIDABLE



CÓDIGO	MEDIDA	€/100			
• INVVA27050	7 x 50	114,159	TX40	100	1.200
• INVVA27060	7 x 60	135,247	TX40	100	600
• INVVA27070	7 x 70	150,110	TX40	100	600
• INVVA27080	7 x 80	162,043	TX40	100	600

• Medidas sin homologar



INV N

Cincado negro

MADERA



CÓDIGO	MEDIDA	€/100			
• INVVN6040	6 x 40	29,925	TX40	100	1.200
• INVVN6050	6 x 50	31,531	TX40	100	1.200
• INVVN6060	6 x 60	34,210	TX40	100	600
• INVVN6070	6 x 70	37,528	TX40	100	600
• INVVN7030	7 x 30	31,152	TX40	100	1.200
• INVVN7040	7 x 40	32,493	TX40	100	1.200
• INVVN7050	7 x 50	37,890	TX40	100	1.200
• INVVN7060	7 x 60	42,807	TX40	100	600
• INVVN7070	7 x 70	43,356	TX40	100	600
• INVVN7080	7 x 80	50,583	TX40	100	600
• INVVN7090	7 x 90	52,263	TX40	100	600

• Medidas sin homologar



Blíster

CÓDIGO	MEDIDA	€/BOLSA	PCS BOLSA	BOLSAS
BZINVN7060	7 x 60	2,459	4	20
BZINVN7070	7 x 70	2,459	4	20
BZINVN7080	7 x 80	2,459	2	15

Caja ventana

CÓDIGO	MEDIDA	€/CAJA	PCS CAJA	CAJAS
VINVN7060	7 x 60	8,823	15	8
VINVN7070	7 x 70	9,316	15	8

ESTRINV Z

Estrella inviolable. Cincada



MADERA



CÓDIGO	MEDIDA	€/100	UD. MIN. VENTA	
ESTRINV40Z	ZINC	4,613	400	100

ESTRINV N

Estrella inviolable. Negra



MADERA



CÓDIGO	MEDIDA	€/100	UD. MIN. VENTA	
ESTRINV40N	NEGRA/BLACK/NOIRE	5,410	400	100



Tornillo de ensamblar

TRE



CÓDIGO	MEDIDA	€/100		
TREZ05050	Ø5 x 50	8,593	300	1.800
TREZ07050	Ø7 x 50	14,350	200	2.400

Blíster

CÓDIGO	MEDIDA	€/BOLSA	PCS B	BOLSAS
BZTREZ05050	Ø5 x 50	1,943	4	20
BZTREZ07050	Ø7 x 50	1,943	4	20

Caja ventana

CÓDIGO	MEDIDA	€/CAJA	PCS	CAJAS
VTREZ05050	Ø5 x 50	5,727	50	8
VTREZ07050	Ø7 x 50	5,507	30	8

TRE-Z

Cincado



CÓDIGO	MEDIDA	€/100		
TREPV05050	Ø5 x 50	9,820	300	1.800
TREPV07050	Ø7 x 50	14,350	200	2.400

Blíster

CÓDIGO	MEDIDA	€/BOLSA	PCS B	BOLSAS
BZTREPV0550	Ø5 x 50	1,943	4	20
BZTREPV0750	Ø7 x 50	1,943	4	20

Caja ventana

CÓDIGO	MEDIDA	€/CAJA	PCS	CAJAS
VTREPV05050	Ø5 x 50	6,207	50	8
VTREPV07050	Ø7 x 50	5,567	30	8

TRE-PV

Pavonado



Tornillo cubierta metal madera

FS



CÓDIGO	MEDIDA	€/100			
AFZN144819	4,8 x 19 P14	15,667	8	250	3.000
AFZN144828	4,8 x 28 P14	18,400	8	250	3.000
AFZN144835	4,8 x 35 P14	19,203	8	250	3.000

FS Z

Cincado

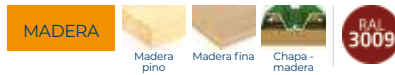

CÓDIGO	MEDIDA	€/100			
AFRT144819	4,8 x 19 P14 3009	19,113	8	250	3.000
AFRT144828	4,8 x 28 P14 3009	21,210	8	250	3.000
AFRT144835	4,8 x 35 P14 3009	25,347	8	250	3.000

FS 3009

RAL 3009. Rojo teja



FS

Tornillo cubierta metal madera

FS 3011

RAL 3011. Rojo pardo

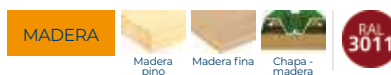

CÓDIGO	MEDIDA	€/100			
AFRD144819	4,8 x 19 P14 3011	19,113	8	250	3.000
AFRD144828	4,8 x 28 P14 3011	21,210	8	250	3.000
AFRD144835	4,8 x 35 P14 3011	25,347	8	250	3.000

FS 5010

RAL 5010. Azul genciana



CÓDIGO	MEDIDA	€/100			
• AFAZ144819	4,8 x 19 P14 5010	19,113	8	250	3.000
• AFAZ144828	4,8 x 28 P14 5010	21,210	8	250	3.000
• AFAZ144835	4,8 x 35 P14 5010	25,347	8	250	3.000

• Hasta fin de existencias

FS 6005

RAL 6005. Verde musgo



CÓDIGO	MEDIDA	€/100			
AFVE144819	4,8 x 19 P14 6005	19,113	8	250	3.000
AFVE144828	4,8 x 28 P14 6005	21,210	8	250	3.000
AFVE144835	4,8 x 35 P14 6005	25,347	8	250	3.000

FS 8004

RAL 8004. Marrón cobre



CÓDIGO	MEDIDA	€/100			
AFMC144819	4,8 x 19 P14 8004	19,113	8	250	3.000
AFMC144828	4,8 x 28 P14 8004	21,210	8	250	3.000
AFMC144835	4,8 x 35 P14 8004	25,347	8	250	3.000

FS 8017

RAL 8017. Marrón chocolate



CÓDIGO	MEDIDA	€/100			
AFMD144819	4,8 x 19 P14 8017	19,113	8	250	3.000
AFMD144828	4,8 x 28 P14 8017	21,210	8	250	3.000
AFMD144835	4,8 x 35 P14 8017	25,347	8	250	3.000



Tornillo cubierta metal madera

FS



CÓDIGO	MEDIDA	€/100			
AFPG144819	4,8 x 19 P14 8019	19,113	8	250	3.000
AFPG144828	4,8 x 28 P14 8019	21,210	8	250	3.000
AFPG144835	4,8 x 35 P14 8019	25,347	8	250	3.000

FS 8019

RAL 8019. Gris pardo



CÓDIGO	MEDIDA	€/100			
AFGR144819	4,8 x 19 P14 9006	19,113	8	250	3.000
AFGR144828	4,8 x 28 P14 9006	21,210	8	250	3.000
AFGR144835	4,8 x 35 P14 9006	25,347	8	250	3.000

FS 9006

RAL 9006. Gris aluminio



CÓDIGO	MEDIDA	€/100			
AFBL144819	4,8 x 19 P14 9010	19,113	8	250	3.000
AFBL144828	4,8 x 28 P14 9010	21,210	8	250	3.000
AFBL144835	4,8 x 35 P14 9010	25,347	8	250	3.000

FS 9010

RAL 9010. Blanco

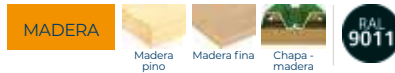

CÓDIGO	MEDIDA	€/100			
AFNE144819	4,8 x 19 P14 9011	19,113	8	250	3.000
AFNE144828	4,8 x 28 P14 9011	21,210	8	250	3.000
AFNE144835	4,8 x 35 P14 9011	25,347	8	250	3.000

FS 9011

RAL 9011. Negro



Tornillo de cabeza cilíndrica especial extraplana con rosca de doble hilo para aluminio. Cincado y huella TX

FIMA



CÓDIGO	MEDIDA	€/100			
TFI4825	4,8 x 25	7,240	TX20	500	6.000
TFI4835	4,8 x 35	8,457	TX20	500	6.000
TFI4845	4,8 x 45	11,077	TX20	500	3.000
TFI4855	4,8 x 55	12,967	TX20	500	3.000
TFI4865	4,8 x 65	15,133	TX20	250	1.500
TFI4875	4,8 x 75	18,440	TX20	250	1.500
TFI4890	4,8 x 90	27,107	TX20	250	1.500



A
ERFEC
FIXIN
NDI



PUNTAS, ALCAYATAS Y HEMBRILLAS



AL

Alcayatas

AL-RE

Alcayata redonda



MULTIMATERIAL



CÓDIGO	MEDIDA	€/100		
ALRE20015	2 x 15 x 7	0,858	500	22.500
ALRE25020	2,5 x 20 x 12	1,858	500	22.500
ALRE25025	2,5 x 25 x 12	2,036	500	12.000
ALRE25030	2,5 x 30 x 12	2,647	300	7.200
ALRE35040	3,5 x 40 x 14	6,521	300	7.200
ALRE35050	3,5 x 50 x 14	6,864	300	3.600
ALRE40060	4 x 60 x 16	9,431	200	2.400
ALRE40070	4 x 70 x 16	11,873	200	1.200
ALRE40080	4 x 80 x 16	13,263	100	1.200

Blíster

CÓDIGO	MEDIDA	€/BOLSA	PCS	BOLSAS
BZALRE20015	2 x 15 x 7	1,943	25	20
BZALRE25020	2,5 x 20 x 12	1,943	25	20
BZALRE25025	2,5 x 25 x 12	1,943	25	20
BZALRE25030	2,5 x 30 x 12	1,943	15	20
BZALRE35040	3,5 x 40 x 14	1,943	15	20
BZALRE35050	3,5 x 50 x 14	1,943	15	20
BZALRE40060	4 x 60 x 16	1,943	10	20
BZALRE40070	4 x 70 x 16	1,943	6	20
BZALRE40080	4 x 80 x 16	1,943	4	20

Caja ventana

CÓDIGO	MEDIDA	€/CAJA	PCS	CAJAS
VALRE25020	2,5 x 20 x 12	3,020	125	8
VALRE25030	2,5 x 30 x 12	3,439	100	8
VALRE35040	3,5 x 40 x 14	8,477	100	8
VALRE35050	3,5 x 50 x 14	8,922	100	8
VALRE40060	4 x 60 x 16	6,129	50	8
VALRE40070	4 x 70 x 16	7,718	50	8
VALRE40080	4 x 80 x 16	5,173	30	8

AL-PL

Alcayata plana



MULTIMATERIAL

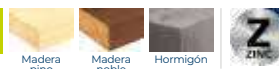

CÓDIGO	MEDIDA	€/100		
ALPL45060	4,5 x 60 x 20	49,547	100	2.400
ALPL45080	4,5 x 80 x 20	62,727	100	1.200
ALPL45100	4,5 x 100 x 20	87,130	100	600
ALPL50120	5 x 120 x 25	128,950	100	400

Blíster

CÓDIGO	MEDIDA	€/BOLSA	PCS	BOLSAS
BZALPL45060	4,5 x 60 x 20	3,216	4	20
BZALPL45080	4,5 x 80 x 20	3,216	4	20
BZALPL45100	4,5 x 100 x 20	3,216	2	15
BZALPL50120	5 x 120 x 25	3,216	2	10



Alcayatas

AL

02 Info
P. 409 Técnica

MADERA



CÓDIGO	€/100	ØD	L1	b	L2	d		
ALRO14025	2,991	2,6	17	10	10	2,6	500	22.500
ALRO16030	3,382	3,1	20	12	10	3,1	300	13.500
ALRO17040	4,756	3,5	29	17	13	3,5	300	7.200
ALRO18040	5,367	3,7	28	17	14	3,7	300	7.200
ALRO18050	5,830	3,7	37	22	15	3,7	300	7.200
ALRO19050	7,572	4,4	37	22	15	4,4	200	4.800
ALRO19060	8,142	4,4	46	28	17	4,4	200	4.800
ALRO19070	9,121	4,4	55	33	18	4,4	200	2.400
ALRO20060	9,972	5	44	26	20	5	200	2.400
ALRO20070	10,686	5	53	32	20	5	200	1.600
ALRO20080	11,970	5	63	38	21	5	200	2.400
ALRO21080	14,421	5,6	60	36	22	5,6	200	2.400
ALRO21090	15,976	5,6	70	42	22	5,6	200	800
ALRO22100	15,999	6	79	47	23	6	100	1.200
ALRO22110	21,676	6	86	52	23	6	100	1.200
ALRO22120	23,313	6	97	58	25	6	50	800
ALRO23130	31,557	7,8	105	63	25	7,8	50	600

AL-RO

Alcayata roscada

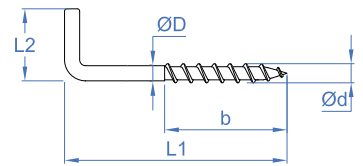

02 Blíster

CÓDIGO	MEDIDA	€/BOLSA	PCS 	BOLSAS 
BZALRO14025	14x25 (2,6 x 17 x 10)	1,943	25	20
BZALRO16030	16x30 (3,1 x 20 x 10)	1,943	15	20
BZALRO17040	17x40 (3,5 x 29 x 13)	1,943	15	20
BZALRO18040	18x40 (3,7 x 28 x 14)	1,943	15	20
BZALRO18050	18x50 (3,7 x 37 x 15)	1,943	15	20
BZALRO19050	19x50 (4,4 x 37 x 15)	1,943	10	20
BZALRO19060	19x60 (4,4 x 46 x 17)	1,943	10	20
BZALRO19070	19x70 (4,4 x 55 x 18)	1,943	10	20
BZALRO20060	20x60 (5 x 44 x 20)	1,943	8	20
BZALRO20070	20x70 (5 x 53 x 20)	1,943	8	20
BZALRO21080	21x80 (5,6 x 60 x 22)	1,943	6	20
BZALRO21090	21x90 (5,6 x 70 x 22)	1,943	6	20
BZALRO22100	22x100 (6 x 79 x 23)	1,943	4	20
BZALRO22110	22x110 (6 x 86 x 23)	1,943	2	20
BZALRO22120	22x120 (6 x 97 x 25)	1,943	2	20
BZALRO23130	23x130 (7,8 x 105 x 25)	1,943	2	20



02 Caja ventana

CÓDIGO	MEDIDA	€/CAJA	PCS 	CAJAS 
VALRO14025	14x25 (2,6 x 17 x 10)	5,000	125	8
VALRO16030	16x30 (3,1 x 20 x 10)	3,413	75	8
VALRO17040	17x40 (3,5 x 29 x 13)	4,793	75	8
VALRO18040	18x40 (3,7 x 28 x 14)	5,383	75	8
VALRO18050	18x50 (3,7 x 37 x 15)	7,048	75	8
VALRO19050	19x50 (4,4 x 37 x 15)	6,104	60	8
VALRO19060	19x60 (4,4 x 46 x 17)	6,564	60	8
VALRO19070	19x70 (4,4 x 55 x 18)	7,353	60	8
VALRO20060	20x60 (5 x 44 x 20)	8,040	60	8
VALRO20070	20x70 (5 x 53 x 20)	8,616	60	8
VALRO20080	20x80 (5 x 63 x 21)	9,650	60	8
VALRO21080	21x80 (5,6 x 60 x 22)	13,567	50	8
VALRO21090	21x90 (5,6 x 70 x 22)	15,029	40	8
VALRO22100	22x100 (6 x 79 x 23)	8,395	35	8
VALRO22110	22x110 (6 x 86 x 23)	10,994	35	8
VALRO22120	22x120 (6 x 97 x 25)	7,285	20	8
VALRO23130	23x130 (7,8 x 105 x 25)	8,764	20	8

02 Info
P. 409 Técnica

MADERA





CÓDIGO	€/100	ØD	L1	b	L2	d		
ALROB16030	7,258	3,1	20	10	10	3,1	300	13.500
ALROB17040	9,174	3,5	29	13	13	3,5	300	7.200
ALROB18050	13,838	3,7	37	18	15	3,7	300	7.200
ALROB19060	15,900	4,4	46	24	17	4,4	200	4.800

AL-RO B



Alcayata roscada lacada blanca



02 Blíster

CÓDIGO	MEDIDA	€/BOLSA	PCS 	BOLSAS 
BZALROB1630	16x30 (3,1 x 20 x 10)	2,459	15	20
BZALROB1740	17x40 (3,5 x 29 x 13)	2,459	15	20
BZALROB1850	18x50 (3,7 x 37 x 15)	2,459	15	20
BZALROB1960	19x60 (4,4 x 46 x 17)	2,459	10	20

02 Caja ventana

CÓDIGO	MEDIDA	€/CAJA	PCS 	CAJAS 
VALROB16030	16x30 (3,1 x 20 x 10)	6,950	75	8
VALROB17040	17x40 (3,5 x 29 x 13)	8,434	75	8
VALROB18050	18x50 (3,7 x 37 x 15)	12,181	75	8
VALROB19060	19x60 (4,4 x 46 x 17)	9,716	50	8

HB

Hembrillas

AL-HC

Hembrilla cerrada

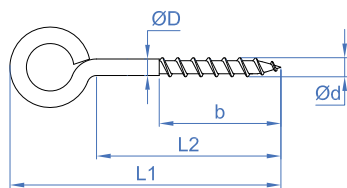

02 Info. Técnica P. 408



CÓDIGO	€/100	ØD	L1	b	L2	d		
ALHC14025	2,991	2.6	18	7	10	2.6	500	22.500
ALHC16030	3,382	3.1	22	9	12	3.1	300	13.500
ALHC17040	4,756	3.5	26	10	14	3.5	300	7.200
ALHC18040	5,367	4.1	28	10	15	4.1	300	7.200
ALHC18050	5,830	4.1	34	12	20	3.7	300	7.200
ALHC19050	7,572	4.4	33	12	18	4.4	200	4.800
ALHC19060	8,142	4.4	39	15	22	4.4	200	4.800
ALHC19070	9,121	4.4	41	15	24	4.4	200	4.800
ALHC20050	9,257	5	35	12	19	5	200	4.800
ALHC20060	9,972	5	39	12	21	5	200	3.200
ALHC20070	10,686	5	44	14	26	5	200	2.400
ALHC20080	11,970	5	50	18	30	5	200	2.400
ALHC21070	13,198	5.6	43	14	23	5.6	200	2.400
ALHC21080	14,421	5.6	48	14	28	5.6	200	2.400
ALHC21090	15,976	5.6	56	14	32	5.6	200	1.200
ALHC21100	15,999	5.6	61	18	37	5.6	100	1.200
ALHC22110	21,676	6	69	24	43	6	100	1.200
ALHC22120	23,313	6	74	29	48	6	50	600
ALHC23130	31,557	6.3	83	35	55	6.3	50	600

02 Info. Técnica P. 408

Blíster

CÓDIGO	MEDIDA	€/BOLSA	PCS	BOLSAS
BZALHC14025	14x25 (2,6 x 18 x 7)	1,943	25	20
BZALHC16030	16x30 (3,1 x 22 x 9)	1,943	15	20
BZALHC17040	17x40 (3,5 x 26 x 10)	1,943	15	20
BZALHC18040	18x40 (4,1 x 28 x 10)	1,943	15	20
BZALHC18050	18x50 (3,7 x 34 x 12)	1,943	15	20
BZALHC19050	19x50 (4,4 x 33 x 12)	1,943	10	20
BZALHC19060	19x60 (4,4 x 39 x 15)	1,943	10	20
BZALHC19070	19x70 (4,4 x 41 x 15)	1,943	10	20
BZALHC20060	20x60 (5 x 39 x 12)	1,943	8	20
BZALHC20070	20x70 (5 x 44 x 14)	1,943	8	20
BZALHC20080	20x80 (5 x 50 x 18)	1,943	8	15
BZALHC21080	21x80 (5,6 x 48 x 14)	1,943	6	15
BZALHC21090	21x90 (5,6 x 56 x 14)	1,943	6	15
BZALHC21100	21x100 (5,6 x 61 x 18)	1,943	4	20
BZALHC22110	22x110 (6 x 69 x 24)	1,943	2	20
BZALHC22120	22x120 (6 x 74 x 29)	1,943	2	20
BZALHC23130	23x130 (6,3 x 83 x 35)	1,943	2	20

02 Info. Técnica P. 408

Caja ventana

CÓDIGO	MEDIDA	€/CAJA	PCS	CAJAS
VALHC14025	14x25 (2,6 x 18 x 7)	5,000	125	8
VALHC16030	16x30 (3,1 x 22 x 9)	3,413	75	8
VALHC17040	17x40 (3,5 x 26 x 10)	4,793	75	8
VALHC18040	18x40 (4,1 x 28 x 10)	5,383	75	8
VALHC18050	18x50 (3,7 x 34 x 12)	7,048	75	8
VALHC19050	19x50 (4,4 x 33 x 12)	6,104	60	8
VALHC19060	19x60 (4,4 x 39 x 15)	6,564	60	8
VALHC19070	19x70 (4,4 x 41 x 15)	7,353	60	8
VALHC20050	20x50 (5 x 35 x 12)	7,463	60	8
VALHC20060	20x60 (5 x 39 x 12)	8,040	60	8
VALHC20070	20x70 (5 x 44 x 14)	8,616	60	8
VALHC20080	20x80 (5 x 50 x 18)	9,650	60	8
VALHC21070	21x70 (5,6 x 43 x 14)	12,350	60	8
VALHC21080	21x80 (5,6 x 48 x 14)	13,567	50	8
VALHC21090	21x90 (5,6 x 56 x 14)	15,029	40	8
VALHC21100	21x100 (5,6 x 61 x 18)	8,395	35	8
VALHC22110	22x110 (6 x 69 x 24)	10,994	20	8
VALHC22120	22x120 (6 x 74 x 29)	7,285	20	8
VALHC23130	23x130 (6,3 x 83 x 35)	8,764	20	8

AL-HC B

Hembrilla cerrada roscada lacada blanca



02 Info. Técnica P. 409



CÓDIGO	€/100	ØD	L1	b	L2	d		
ALHCB16030	7,258	3.1	22	9	12	3.1	300	13.500
ALHCB17040	9,174	3.5	26	10	14	3.5	300	7.200
ALHCB18050	13,838	3.7	34	12	20	3.7	300	7.200
ALHCB19060	15,900	4.4	39	15	22	4.4	200	4.800

02 Info. Técnica P. 409

Blíster

CÓDIGO	MEDIDA	€/BOLSA	PCS	BOLSAS
BZALHCB1630	16x30 (3,1 x 22 x 9)	2,459	15	20
BZALHCB1740	17x40 (3,5 x 26 x 10)	2,459	15	20
BZALHCB1850	18x50 (3,7 x 34 x 12)	2,459	15	20
BZALHCB1960	19x60 (4,4 x 39 x 15)	2,459	10	20

Hembrillas

HB





MADERA



AL-HA

Hembrilla abierta

CÓDIGO	€/100	ØD	L1	b	L2	d		
ALHA14025	2,991	2.6	18	7	10	2.6	500	22.500
ALHA16030	3,382	3.1	22	9	12	3.1	300	13.500
ALHA17040	4,756	3.5	27	10	14	3.5	300	7.200
ALHA18040	5,367	4.1	29	10	15	4.1	300	7.200
ALHA18050	5,830	4.1	38	12	20	4.1	300	3.600
ALHA19050	7,572	4.4	35	12	18	4.4	200	4.800
ALHA19060	8,142	4.4	42	15	22	4.4	200	4.800
ALHA19070	9,121	4.4	44	15	24	4.4	200	2.400
ALHA20050	9,257	5	39	12	19	5	200	2.400
ALHA20060	9,972	5	41	12	21	5	200	2.400
ALHA20070	10,686	5	48	14	26	5	200	2.400
ALHA20080	11,970	5	54	18	30	5	200	2.400
ALHA21070	13,198	5.6	49	14	23	5.6	200	2.400
ALHA21080	14,421	5.6	54	14	28	5.6	200	2.400
ALHA21090	15,976	5.6	60	14	32	5.6	200	1.200
ALHA21100	15,999	5.6	66	18	37	5.6	100	1.200
ALHA22110	21,676	6	76	24	43	6	100	1.200
ALHA22120	23,313	6	81	29	48	6	50	600
ALHA23130	31,557	6.3	89	35	55	6.3	50	600

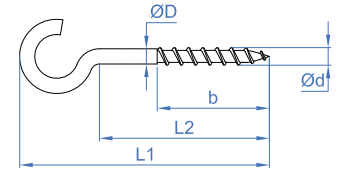

Blíster

CÓDIGO	MEDIDA	€/BOLSA	PCS	BOLSAS
BZALHA14025	14x25 (2,6 x 18 x 7)	1,943	25	20
BZALHA16030	16x30 (3,1 x 22 x 9)	1,943	15	20
BZALHA17040	17x40 (3,5 x 26 x 10)	1,943	15	20
BZALHA18040	18x40 (4,1 x 29 x 10)	1,943	15	20
BZALHA18050	18x50 (4,1 x 34 x 12)	1,943	15	20
BZALHA19050	19x50 (4,4 x 33 x 12)	1,943	10	20
BZALHA19060	19x60 (4,4 x 39 x 15)	1,943	10	20
BZALHA19070	19x70 (4,4 x 41 x 15)	1,943	10	20
BZALHA20060	20x60 (5 x 39 x 12)	1,943	8	20
BZALHA20070	20x70 (5 x 44 x 14)	1,943	8	20
BZALHA20080	20x80 (5 x 50 x 18)	1,943	8	20
BZALHA21080	21x80 (5,6 x 48 x 14)	1,943	6	20
BZALHA21090	21x90 (5,6 x 56 x 14)	1,943	6	20
BZALHA21100	21x100 (5,6 x 61 x 18)	1,943	5	15
BZALHA22110	22x110 (6 x 69 x 24)	1,943	2	15
BZALHA22120	22x120 (6 x 74 x 29)	1,943	2	15
BZALHA23130	23x130 (6,3 x 82 x 35)	1,943	2	15

Caja ventana

CÓDIGO	MEDIDA	€/CAJA	PCS	CAJAS
VALHA14025	14x25 (2,6 x 18 x 7)	5,000	125	8
VALHA16030	16x30 (3,1 x 22 x 9)	3,413	75	8
VALHA17040	17x40 (3,5 x 26 x 10)	4,793	75	8
VALHA18040	18x40 (4,1 x 29 x 10)	5,383	75	8
VALHA18050	18x50 (4,1 x 34 x 12)	7,048	75	8
VALHA19050	19x50 (4,4 x 33 x 12)	6,104	60	8
VALHA19060	19x60 (4,4 x 39 x 15)	6,564	60	8
VALHA19070	19x70 (4,4 x 41 x 15)	7,353	60	8
VALHA20050	20x50 (5 x 35 x 12)	7,463	60	8
VALHA20060	20x60 (5 x 39 x 12)	8,040	60	8
VALHA20070	20x70 (5 x 44 x 14)	8,616	60	8
VALHA20080	20x80 (5 x 50 x 18)	9,650	60	8
VALHA21070	21x70 (5,6 x 43 x 14)	12,350	60	8
VALHA21080	21x80 (5,6 x 48 x 14)	13,567	50	8
VALHA21090	21x90 (5,6 x 56 x 14)	15,029	40	8
VALHA21100	21x100 (5,6 x 61 x 18)	8,395	35	8
VALHA22110	22x110 (6 x 69 x 24)	10,994	20	8
VALHA22120	22x120 (6 x 74 x 29)	7,285	20	8
VALHA23130	23x130 (6,3 x 82 x 35)	8,764	20	8





MADERA



AL-HA B

Hembrilla abierta roscada lacada blanca

CÓDIGO	€/100	ØD	L1	b	L2	d		
ALHAB16030	7,258	3.1	22	9	12	3.1	300	13.500
ALHAB17040	9,174	3.5	26	10	14	3.5	300	7.200
ALHAB18050	13,838	4.1	34	12	20	3.7	300	7.200
ALHAB19060	15,900	4.4	39	15	22	4.4	200	4.800



Blíster

CÓDIGO	MEDIDA	€/BOLSA	PCS	BOLSAS
BZALHAB1630	16x30 (3,1 x 22 x 9)	2,459	15	20
BZALHAB1740	17x40 (3,5 x 26 x 10)	2,459	15	20
BZALHAB1850	18x50 (4,1 x 34 x 12)	2,459	15	20
BZALHAB1960	19x60 (4,4 x 39 x 15)	2,459	10	20

Caja ventana

CÓDIGO	MEDIDA	€/CAJA	PCS	CAJAS
VALHAB16030	16x30 (3,1 x 22 x 9)	6,950	75	8
VALHAB17040	17x40 (3,5 x 26 x 10)	8,434	75	8
VALHAB18050	18x50 (4,1 x 34 x 12)	12,181	75	8
VALHAB19060	19x60 (4,4 x 39 x 15)	9,716	50	8

HB

Hembrillas



HC-RM

Hembrilla cerrada. Rosca métrica con tuerca



MULTIMATERIAL



CÓDIGO	MEDIDA	€/100		
HCRM03026	3 x 26	27,867	100	4.500
HCRM04035	4 x 35	30,961	100	2.400
HCRM05037	5 x 37	36,977	100	1.200
HCRM06050	6 x 50	74,819	100	1.200
HCRM08060	8 x 60	85,997	100	600
HCRM10065	10 x 65	154,793	50	300
HCRM12075	12 x 75	206,388	50	150

 Blíster

CÓDIGO	MEDIDA	€/BOLSA	PCS	BOLSAS
BZHCRM03026	3 x 26	1,943	15	20
BZHCRM04035	4 x 35	1,943	15	20
BZHCRM05037	5 x 37	1,943	8	20
BZHCRM06050	6 x 50	1,943	6	20
BZHCRM08060	8 x 60	1,943	2	20
BZHCRM10065	10 x 65	1,943	2	20

HA-RM

Hembrilla abierta. Rosca métrica con tuerca



MULTIMATERIAL



CÓDIGO	MEDIDA	€/100		
HARM03026	3 x 26	27,867	100	4.500
HARM04035	4 x 35	30,961	100	2.400
HARM05037	5 x 37	36,977	100	1.200
HARM06050	6 x 50	74,819	100	1.200
HARM08060	8 x 60	85,997	50	300

 Blíster

CÓDIGO	MEDIDA	€/BOLSA	PCS	BOLSAS
BZHARM03026	3 x 26	1,943	15	20
BZHARM04035	4 x 35	1,943	15	20
BZHARM05037	5 x 37	1,943	8	20
BZHARM06050	6 x 50	1,943	6	20
BZHARM08060	8 x 60	1,943	2	20

Puntas clavado



PC

MULTIMATERIAL





PA-CP

Puntas acero cabeza plana

CÓDIGO	MEDIDA	€/100		
PACP22520	2,25 x 20	1,170	500	22.500
PACP22525	2,25 x 25	1,352	500	22.500
PACP22530	2,25 x 30	1,563	500	12.000
PACP25040	2,50 x 40	2,541	500	12.000
PACP25050	2,50 x 50	2,679	500	6.000
PACP29050	2,90 x 50	3,806	300	3.600
PACP29060	2,90 x 60	4,456	300	3.600
PACP29070	2,90 x 70	5,112	300	2.400
PACP34030	3,40 x 30	3,042	500	4.000
PACP34040	3,40 x 40	3,556	500	6.000
PACP34050	3,40 x 50	5,251	100	4.500
PACP34060	3,40 x 60	5,676	100	2.400
PACP34070	3,40 x 70	6,498	100	2.400
PACP34080	3,40 x 80	7,887	100	1.600



 Blíster



CÓDIGO	MEDIDA	€/BOLSA	PCS 	BOLSAS 
BZPACP22520	2,25 x 20	2,459	50	20
BZPACP22525	2,25 x 25	2,459	50	20
BZPACP22530	2,25 x 30	2,459	50	20
BZPACP25040	2,50 x 40	2,459	35	20
BZPACP25050	2,50 x 50	2,459	30	20
BZPACP29060	2,90 x 60	2,459	20	20
BZPACP29070	2,90 x 70	2,459	20	20
BZPACP34040	3,40 x 40	2,459	20	20
BZPACP34050	3,40 x 50	2,459	10	20
BZPACP34060	3,40 x 60	2,459	10	20
BZPACP34070	3,40 x 70	2,459	10	20

MADERA



PA-CC

Puntas acero cabeza cónica cobreada

CÓDIGO	MEDIDA	€/100		
PACC15015	1,5 x 15	0,523	800	36.000
PACC15020	1,5 x 20	0,657	800	36.000
PACC15025	1,5 x 25	0,920	500	22.500
PACC20025	2 x 25	1,257	500	22.500
PACC20030	2 x 30	1,423	500	12.000
PACC20035	2 x 35	1,633	500	12.000
PACC20040	2 x 40	1,833	500	12.000
PACC20045	2 x 45	2,140	500	6.000
PACC20050	2 x 50	2,340	500	6.000



 Blíster

CÓDIGO	MEDIDA	€/BOLSA	PCS 	BOLSAS 
BZPACC15015	1,5 x 15	1,943	75	20
BZPACC15020	1,5 x 20	1,943	50	20
BZPACC15025	1,5 x 25	1,943	50	20
BZPACC20025	2 x 25	1,943	50	20
BZPACC20030	2 x 30	1,943	50	20
BZPACC20035	2 x 35	1,943	50	20
BZPACC20040	2 x 40	1,943	35	20
BZPACC20045	2 x 45	1,943	35	20
BZPACC20050	2 x 50	1,943	30	20

 Caja ventana

CÓDIGO	MEDIDA	€/CAJA	PCS 	CAJAS 
VPACC15015	1,5 x 15	2,512	240	8
VPACC15020	1,5 x 20	2,994	240	8
VPACC15025	1,5 x 25	3,091	150	8
VPACC20025	2 x 25	3,393	150	8
VPACC20030	2 x 30	3,416	150	8
VPACC20035	2 x 35	3,920	150	8
VPACC20040	2 x 40	4,400	150	8
VPACC20045	2 x 45	5,136	150	8
VPACC20050	2 x 50	5,616	150	8

PC

Puntas clavado

PA-CX

Puntas latón cabeza convexa

MADERA



Blíster

CÓDIGO	MEDIDA	€/BOLSA	PCS	BOLSAS
BZPACX11010	1,1 x 10	2,459	75	20
BZPACX13012	1,3 x 12	2,459	50	20
BZPACX13020	1,3 x 20	2,459	40	20
BZPACX15016	1,5 x 16	2,459	35	20
BZPACX15025	1,5 x 25	2,459	20	20
BZPACX18030	1,8 x 30	2,459	20	20

GM-Z

Grampillón



MADERA



CÓDIGO	MEDIDA	€/100		
GMZ08012	8 x 12	0,523	800	36.000
GMZ10016	10 x 16	0,874	800	19.200
GMZ12020	12 x 20	1,495	800	19.200
GMZ15026	15 x 26	3,360	600	7.200
GMZ17030	17 x 30	5,472	600	7.200
GMZ19035	19 x 35	8,335	400	4.800

Blíster

CÓDIGO	MEDIDA	€/BOLSA	PCS	BOLSAS
BZGMZ08012	8 x 12	1,943	50	20
BZGMZ10016	10 x 16	1,943	40	20
BZGMZ12020	12 x 20	1,943	50	20
BZGMZ15026	15 x 26	1,943	40	20
BZGMZ17030	17 x 30	1,943	25	20
BZGMZ19035	19 x 35	1,943	15	20

Caja ventana

CÓDIGO	MEDIDA	€/CAJA	PCS	CAJAS
VGMZ10016	10 x 16	2,727	240	8
VGMZ15026	15 x 26	8,731	200	8
VGMZ19035	19 x 35	10,837	100	8

CF-B

Colgador cuadro fácil



MULTIMATERIAL



CÓDIGO	MEDIDA	€/100		
CFBL	Blanco	13,413	200	9.000

Blíster

CÓDIGO	MEDIDA	€/BOLSA	PCS	BOLSAS
BZCFBL	Blanco	2,459	10	20



Caja ventana

CÓDIGO	MEDIDA	€/CAJA	PCS	CAJAS
VCFBL	Blanco	25,187	150	8

Puntas clavado

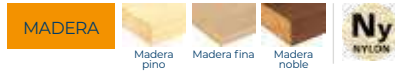
PC



CÓDIGO	MEDIDA	€/100		
SVNB01	Pequeño	12,473	300	3.600
SVNB02	Grande	17,007	200	2.400

SV-NB

Soporte vitrina blanco

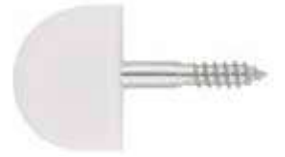



 Blíster

CÓDIGO	MEDIDA	€/BOLSA	PCS 	BOLSAS 
BZSVNB01	Pequeño	3,216	10	20
BZSVNB02	Grande	3,216	8	20

 Caja ventana

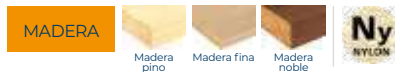
CÓDIGO	MEDIDA	€/CAJA	PCS 	CAJAS 
VSVNB01	Pequeño	13,567	90	8
VSVNB02	Grande	10,663	50	8



CÓDIGO	MEDIDA	€/100		
SVNM01	Pequeño	12,473	300	3.600
SVNM02	Grande	17,007	200	2.400

SV-NM

Soporte vitrina marrón





 Blíster

CÓDIGO	MEDIDA	€/BOLSA	PCS 	BOLSAS 
BZSVNM01	Pequeño	3,216	10	20
BZSVNM02	Grande	3,216	8	20

 Caja ventana

CÓDIGO	MEDIDA	€/CAJA	PCS 	CAJAS 
VSVNM01	Pequeño	13,567	90	8
VSVNM02	Grande	10,663	50	8



CÓDIGO	MEDIDA	€/100		
SVCBL	Blanco	17,007	300	3.600
SVCMA	Marrón	17,007	300	3.600

SV-C

Soporte vitrina cuadrado 2 puntas

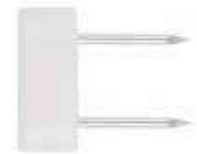

 Blíster

CÓDIGO	MEDIDA	€/BOLSA	PCS 	BOLSAS 
BZSVCBL	Blanco	3,216	10	20
BZSVCMA	Marrón	3,216	10	20

 Caja ventana

CÓDIGO	MEDIDA	€/CAJA	PCS 	CAJAS 
VSVCBL	Blanco	17,963	90	8
VSVCMA	Marrón	17,963	90	8

MALETINES MULTIREFERENCIA

MALETÍN PROFESIONAL: TIRAFONDOS MADERA + PUNTAS



2.008 pcs.
COD. MLTPPOP101

TP-PO 3 x 20 x300	TP-PO 3 x 25 x250	TP-PO 3,5 x 16 x300	TP-PO 3,5 x 20 x250
TP-PO 3,5 x 25 x200	TP-PO 3,5 x 30 x150	TP-PO 3,5 x 35 x130	TP-PO 4 x 30 x130
TP-PO 4 x 40 x80	TP-PO 4 x 50 x60	TP-PO 5 x 50 x50	TP-PO 5 x 60 x50
TP-PO 5 x 80 x50			PUNTAS x8

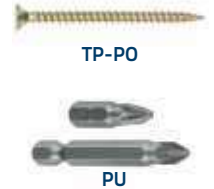

CARACTERÍSTICAS:

- Maletín multiproducto de alta calidad
- Tamaño: 31,2 x 23,8 x 5,1 cms. (Ancho x Fondo x Alto)
- Ergonómico y de fácil manejo
- Apilable
- Configurable hasta 21 cavidades
- Separadores regulables
- Tapa con nervios que evita que se mezclen los tornillos
- Cierre resistente y duradero

CÓDIGO	CONTENIDO	Nº PIEZAS	€/1 pc.
MLTPPOP101	TP-PO+PUNTAS	2.008	71,007

MALETÍN PROFESIONAL MULTIPRODUCTO



670 pcs.
COD. MLTBOP101

TP-PO 5 x 60 x30	TP-PO 5 x 70 x20	TP-PO 5 x 80 x20	DIN-571 6 x 60 x25
TP-PO 4 x 50 x50	TP-PO 5 x 50 x50	TACON Ø 10 x15	DIN-571 6 x 50 x30
TP-PO 3,5 x 25 x60	TP-PO 4 x 30 x70	TP-PO 4 x 40 x70	DIN-571 6 x 40 x30
			TACON Ø 6 x150

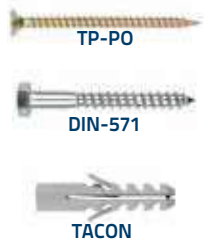

CARACTERÍSTICAS:

- Maletín multiproducto de alta calidad
- Tamaño: 31,2 x 23,8 x 5,1 cms. (Ancho x Fondo x Alto)
- Ergonómico y de fácil manejo
- Apilable
- Configurable hasta 21 cavidades
- Separadores regulables
- Tapa con nervios que evita que se mezclen los tornillos
- Cierre resistente y duradero

CÓDIGO	CONTENIDO	Nº PIEZAS	€/1 pc.
MLTBOP101	TP-PO+DIN-571 +TACON	670	60,981

MALETINES MULTIREFERENCIA

MALETÍN TRANSPARENTE

CARACTERÍSTICAS:

- Tres composiciones adaptadas a las necesidades de cada cliente.
- Tres tamaños disponibles para cada composición.
- Permite colgarse en lineal. Dispone de un colgador de alta resistencia.
- Composiciones ideales para aumentar la compra impulsiva en el punto de venta.
- Tapa con nervios que evita que se mezclen los tornillos.

TAMAÑOS



GRANDE
29,5 x 18,5 x 4,5 cms.
(Ancho x Fondo x Alto)



MEDIANO
23,5 x 14,5 x 4 cms.
(Ancho x Fondo x Alto)



PEQUEÑO
16 x 10,5 x 3,5 cms.
(Ancho x Fondo x Alto)

COMPOSICIONES:

MADERA



TP-PO



PU-PO

CÓDIGO	CONTENIDO	TAMAÑO	Nº PIEZAS	€/1 pc.
MLTTPOT101	TP-PO + PUNTAS	PEQUEÑO	407	17,392
MLTTPOT201	TP-PO + PUNTAS	MEDIANO	902	32,291
MLTTPOT301	TP-PO + PUNTAS	GRANDE	1.742	52,105

MULTIPRODUCTO



TACON



AL-RO



AL-HA



AL-HC



TP-PO Z



DIN-571

CÓDIGO	CONTENIDO	TAMAÑO	Nº PIEZAS	€/1 pc.
MLMULT101	MULTIPRODUCTO	PEQUEÑO	165	16,735
MLMULT201	MULTIPRODUCTO	MEDIANO	415	31,072
MLMULT301	MULTIPRODUCTO	GRANDE	1.155	49,244

PLACA DE YESO LAMINADO



AL-HC



AL-RO



AL-HA



TP-PO Z



ANCLA



IN-CO



T4S



TAPLANY



TAPLAME
+ DIN-7981

CÓDIGO	CONTENIDO	TAMAÑO	Nº PIEZAS	€/1 pc.
MLPLAT101	MULTIPRODUCTO	PEQUEÑO	130	16,735
MLPLAT201	MULTIPRODUCTO	MEDIANO	295	31,072
MLPLAT301	MULTIPRODUCTO	GRANDE	455	49,244



CONECTORES PARA MADERA



SO

Soportes perforados

SO-UO

Con orificios de sellado

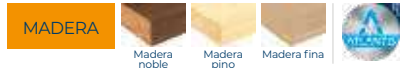

CÓDIGO	MEDIDA	€/100	N° AGUJEROS	Ø ORIFICIOS	ESPEJOR	
SOU004110	40 x 110 x 80	533,927	4/1/22	11/7/4,6	2	25
SOU006100	60 x 100 x 80	537,409	4/1/22	11/7/4,6	2	25
SOU007125	70 x 125 x 80	605,610	4/1/28	11/7/4,6	2	25
SOU008120	80 x 120 x 80	608,335	4/1/28	11/7/4,6	2	25
SOU010140	100 x 140 x 80	723,380	4/1/34	11/7/4,6	2	10

SO-UR

De ancho variable con orificios de sellado



CÓDIGO	MEDIDA	€/100	N° AGUJEROS	Ø ORIFICIOS	ESPEJOR	
SOUR30140DR	26 x 140 x 76	626,717	2/20	11/4,5	2	25
SOUR30140IZ	26 x 140 x 76	626,717	2/20	11/4,5	2	25

SC

Escuadras para unión de madera

SC-EI

De ensamblaje, perforada con orificios iguales

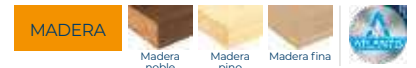

CÓDIGO	MEDIDA	€/100	N° AGUJEROS	Ø ORIFICIOS	ESPEJOR	
SCEI040402	40 x 40 x 20	67,897	6	4,5	2	100
SCEI040404	40 x 40 x 40	106,703	8	4,6	2	50
SCEI040406	40 x 40 x 60	174,687	12	4,6	2,5	50
SCEI050504	50 x 50 x 40	123,197	8	4,5	2	50
SCEI060604	60 x 60 x 40	170,467	12	5	2,5	50
SCEI060606	60 x 60 x 60	216,283	18	5	2,5	50
SCEI060608	60 x 60 x 80	381,760	20	4,6	2,5	25
SCEI070704	75 x 75 x 40	236,153	12	4,6	2	50
SCEI080808	80 x 80 x 80	427,600	28	4,6	2,5	25
SCEI101004	100 x 100 x 40	271,923	14	4,6	2	50
SCEI101010	100 x 100 x 100	693,680	46	4,6	2,5	25

SC-ED

De ensamblaje, perforada con orificios desiguales



CÓDIGO	MEDIDA	€/100	N° AGUJEROS	Ø ORIFICIOS	ESPEJOR	
SCED050503	50 x 50 x 35	125,160	2/12	11/4,5	2,5	50
SCED060604	60 x 60 x 45	196,113	2/12	10,4/4,8	2,5	50
SCED070705	70 x 70 x 55	263,917	2/20	10,4/4,6	2,5	50
SCED090904	90 x 90 x 40	280,903	4/16	10,4/4,6	3	50
SCED090906	90 x 90 x 65	296,910	5/15	12,8/4,6	2,5	25
SCED101009	105 x 105 x 90	600,507	5/29	12,8/4,6	3	25

SC-LD

De ensamblaje de lados iguales



CÓDIGO	MEDIDA	€/100	N° AGUJEROS	Ø ORIFICIOS	ESPEJOR	
SCLD040606	60 x 60 x 40	277,940	2/13	11/5	2,5	50
SCLD060806	60 x 80 x 60	353,073	3/18	11/5	2,5	50

Escuadras para unión de madera

SC

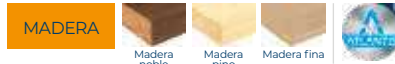

CÓDIGO	MEDIDA	€/100	Nº AGUJEROS	Ø ORIFICIOS	ESPESOR	
SCGA100404	40 x 40 x 100	289,340	16	5	2	25

SC-GA

Grande de ángulo

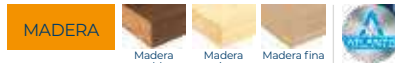

CÓDIGO	MEDIDA	€/100	Nº AGUJEROS	Ø ORIFICIOS	ESPESOR	
SCRF070705	70 x 70 x 55	285,480	2/12	2/12	2	50
SCRF070605	77 x 64 x 50	260,720	2/10	11/4,6	2.5	50
SCRF090906	90 x 90 x 65	372,020	2/24	11/4,5	2.5	25
SCRF101009	100 x 100 x 90	644,413	4/26	13,4/4,6	3	25
SCRF151506	150 x 150 x 65	608,147	3/13/1/15	11/5/11x32/5	2.5	25

SC-RF

Reforzada

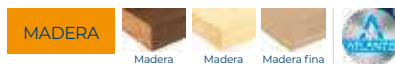

CÓDIGO	MEDIDA	€/100	Nº AGUJEROS	Ø ORIFICIOS	ESPESOR	
SCRG090505	50 x 90 x 50	285,970	3/15	11/4,6	2.5	50
SCRG090508	50 x 90 x 80	400,897	5/16	13/4,6	2.5	50

SC-RG

Regulable

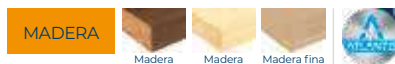

CÓDIGO	MEDIDA	€/100	Nº AGUJEROS	Ø ORIFICIOS	ESPESOR	
SCAS3317DR	32 x 100 x 170	200,743	20	5	2	50
SCAS3317IZ	32 x 100 x 170	200,743	20	5	2	50

SC-AS

Asimétrica, derecha o izquierda

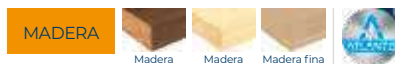

CÓDIGO	MEDIDA	€/100	Nº AGUJEROS	Ø ORIFICIOS	ESPESOR	
SCCE200404	40 x 200 x 40	315,650	18+1	4,5/11	2	10

SC-CE

Para cemento



SC Escuadras para unión de madera

SC-OB

Bicromatada para sillas con orificios biselados en ambas caras

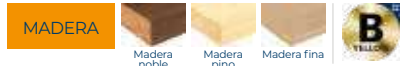

CÓDIGO	MEDIDA	€/100	Nº AGUJEROS	Ø ORIFICIOS	ESPEJOR	
SCOB020214	25 x 25 x 15	49,960	4	4	1.8	100
SCOB030314	30 x 30 x 15	57,407	4	4,6	2	100
SCOB040415	40 x 40 x 15	67,017	4	4,5	1.8	100
SCOB050515	50 x 50 x 15	75,350	4	5	2	100
SCOB060618	60 x 60 x 16	82,963	4	5	2	100
SCOB070718	75 x 75 x 18	108,733	4	5,2	2	50
SCOB090920	90 x 90 x 20	146,607	4	6,5	2	50
SCOB101020	100 x 100 x 20	161,947	6	5,5	2	40
SCOB121222	125 x 125 x 22	259,757	6	5,5	2.5	40

SC-OZ

Cincada para sillas con orificios biselados en ambas caras



CÓDIGO	MEDIDA	€/100	Nº AGUJEROS	Ø ORIFICIOS	ESPEJOR	
SCOZ151525	150 x 150 x 25	391,053	6	6	3	10

SC-CD Z

Cincada grande y de caras desiguales



CÓDIGO	MEDIDA	€/100	Nº AGUJEROS	Ø ORIFICIOS	ESPEJOR	
SCCDZ402575	25 x 40 x 75	256,557	5	4,6	2	20

SC-CI

Bicromatada grande y de caras iguales



CÓDIGO	MEDIDA	€/100	Nº AGUJEROS	Ø ORIFICIOS	ESPEJOR	
SCCI303030	30 x 30 x 30	90,690	4	4,6	2	100
SCCI404040	40 x 40 x 40	114,787	4	4,6	2	50
SCCI606060	60 x 60 x 60	236,527	8	4,5	2	50

SC-EM

Bicromatada para empotrar

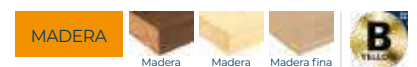

CÓDIGO	MEDIDA	€/100	Nº AGUJEROS	Ø ORIFICIOS	ESPEJOR	
SCEM081240	80 x 120 x 40	609,440	5	4,7	1.6	20
SCEM101640	100 x 160 x 37	669,066	5	4,5	2	20

Escuadras para unión de madera

SC

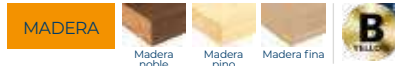

CÓDIGO	MEDIDA	€/100	Nº AGUJEROS	Ø ORIFICIOS	ESPESOR	
SCER302525	25 x 25 x 30	119,470	1/2	4,5 x 14/4,5	1.2	50
SCER392822	39 x 28 x 22	102,390	1/1	4,5 x 16/4,5	1	50

SC-ER

Bicromatada regulable para empotrar

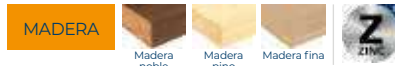

CÓDIGO	MEDIDA	€/100	Nº AGUJEROS	Ø ORIFICIOS	ESPESOR	
SCGEZ704025	25 x 40 x 70	247,287	5	4,5	1.5	20

SC-GE Z

Cincada grande y regulable para empotrar

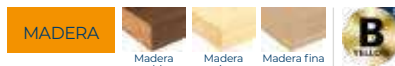

CÓDIGO	MEDIDA	€/KIT	Nº AGUJEROS	Ø ORIFICIOS	ESPESOR	
SCMX020214	25 x 25 x 14	4,293	4	4	1.8	10
SCMX030314	30 x 30 x 14	4,740	4	4	1.8	10
SCMX040415	40 x 40 x 15	5,454	4	4,2	1.8	10
SCMX050515	50 x 50 x 15	6,844	4	4,6	1.8	10
SCMX060618	60 x 60 x 18	7,760	4	4,5	1.8	10
SCMX070718	75 x 75 x 18	8,191	4	5	2	10

SC-MX

Bicromatada para sillas en maxipack (10 uds)



CÓDIGO	MEDIDA	€/100	Nº AGUJEROS	Ø ORIFICIOS	ESPESOR	
SCPD107530	75 x 100 x 30	273,203	5	5	2.5	50
SCPD128035	80 x 120 x 35	469,013	7	4,5	3.5	25

SC-PD

Bicromatada para poste, de caras desiguales

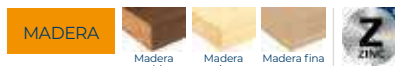

CÓDIGO	MEDIDA	€/100	Nº AGUJEROS	Ø ORIFICIOS	ESPESOR	
SCREZ357565	35 x 75 x 65	583,980	3/2/2	7/7 x 25/7 x 60	3	10

SC-RE Z

Cincada regulable

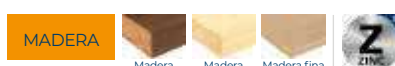

CÓDIGO	MEDIDA	€/100	Nº AGUJEROS	Ø ORIFICIOS	ESPESOR	
SCLCZ354030	34 x 38 x 30	149,033	2	4	2	100

SC-LC Z

Cincada en L para cercados de celosía con tornillo soldado



PT

Pletinas para unión de madera

PT-BR

De ensamble y brida plana

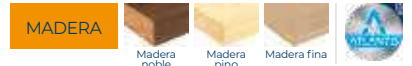

CÓDIGO	MEDIDA	€/100	Nº AGUJEROS	Ø ORIFICIOS	ESPESOR	
PTBR10035	95 x 35	131,447	2/12	11/4,5	2.5	50
PTBR13355	135 x 55	294,177	2/20	11/4,5	2.5	50

PT-EM

Bicromatada para empotrar



CÓDIGO	MEDIDA	€/100	Nº AGUJEROS	Ø ORIFICIOS	ESPESOR	
PTEM18040	180 x 40	360,107	6	4,7	2	20

PT-ET

En "T"



CÓDIGO	MEDIDA	€/100	Nº AGUJEROS	Ø ORIFICIOS	ESPESOR	
PTET169845	160 x 98 x 45	1.356,280	4/20	11/4,5	2.5	25

PT-OB

Bicromatada de unión, con orificios biselados en ambas caras



CÓDIGO	MEDIDA	€/100	Nº AGUJEROS	Ø ORIFICIOS	ESPESOR	
PTOB05015	50 x 15	58,520	4	4,7	1.75	100
PTOB06015	60 x 15	66,887	4	4,5	1.75	100
PTOB08015	80 x 15	75,247	4	4,5	1.75	100
PTOB10015	100 x 15	83,613	4	5	1.75	100
PTOB12020	120 x 20	91,923	4	5,5	1.75	100

PT-TT

En "T"



CÓDIGO	MEDIDA	€/100	Nº AGUJEROS	Ø ORIFICIOS	ESPESOR	
PTT030716	70 x 35 x 16	167,350	6	4,3	1.5	50
PTTT111430	140 x 80 x 30	387,170	6	5	2	25

PT-UN

De ensamble universal



CÓDIGO	MEDIDA	€/100	Nº AGUJEROS	Ø ORIFICIOS	ESPESOR		
PTUN12038	120 x 40	146,380	10	11/4,5	2	50	-
PTUN16038	160 x 40	210,653	12	11/4,5	2	100	400
PTUN20060	200 x 60	311,673	2/26	11/4,5	2	25	-
PTUN20080	200 x 80	344,467	2/38	11/4,5	2	25	75
PTUN24060	240 x 60	433,270	2/32	11/4,5	2	25	-
PTUN24080	240 x 80	533,927	2/46	11/4,5	2	25	50

Anclajes para postes

AP

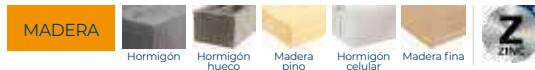

CÓDIGO	MEDIDA	€/100	Nº AGUJEROS	ESPESOR	
APAR070	70 x 70 x 100 x 100	5.142,935	8	5	1
APAR150	150 x 150 x 100 x 100	6.682,727	8	5	1

AP-AR

Altura regulable



CÓDIGO	MEDIDA	€/100	Nº AGUJEROS	Ø ORIFICIOS	ESPESOR	
APAT071	71 x 200 x 60 x 50	2.577,547	6	10,5	4	1
APAT091	91 x 200 x 60 x 50	2.767,807	6	10,5	4	1
APAT101	101 x 200 x 60 x 50	2.863,300	6	10,5	4	1

AP-AT

En "U" para atornillar directamente o sobre espárragos



CÓDIGO	MEDIDA	€/100	Nº AGUJEROS	Ø ORIFICIOS	ESPESOR	
APFL801020	80 x 100 x 200 x 60	2.058,330	3	11	4	1

AP-FL

En "L", soldado y con pata de acero corrugado



CÓDIGO	MEDIDA	€/100	Nº AGUJEROS	Ø ORIFICIOS	ESPESOR	
APFUZ100	60-140 x 115 x 100 x 70	4.838,887	3/4	11/7	4,5	1

AP-FU Z

Cincado en "U" con ancho regulable



CÓDIGO	MEDIDA	€/100	Nº AGUJEROS	Ø ORIFICIOS	ESPESOR	
APPD100	100 x 100 x 150 x 43	6.717,812	8	10,5	5	1

AP-PD

Desigual



CÓDIGO	MEDIDA	€/100	Nº AGUJEROS	Ø ORIFICIOS	ESPESOR	
APPG070	70 x 90 x 70 x 80 x 90	4.758,656	8	8,5	5	1
APPG100	100 x 100 x 100 x 100 x 100	5.678,456	8	10,5	5	1

AP-PG

Igual



AP Anclajes para postes

AP-PT

En "U" soldado con pata de acero corrugada

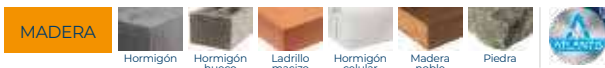

CÓDIGO	MEDIDA	€/100	Nº AGUJEROS	Ø ORIFICIOS	ESPESOR	
APPT071	71 x 100 x 200 x 60	2.392,637	6	10,5	4	1
APPT091	91 x 100 x 200 x 60	2.507,676	6	10,5	4	1
APPT101	101 x 100 x 200 x 60	2.561,282	6	10,5	4	1

AP-UE Z

Cincado en "U" para empotrar con ancho regulable

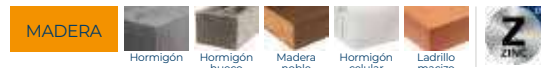

CÓDIGO	MEDIDA	€/100	Nº AGUJEROS	Ø ORIFICIOS	ESPESOR	
APUEZ200	71-131 x 110 x 200 x 70	4.869,633	6	11-7	4,5	1

AP-SB

Sobre base



CÓDIGO	MEDIDA	€/100	Nº AGUJEROS	Ø ORIFICIOS	ESPESOR	UD. MIN. VENTA	
APSB71	71 x 71 x 150	1.894,930	2	4 x 11	1,8	2	1
APSB91	91 x 91 x 150	2.380,617	2	4 x 11	1,8	2	1

AP-EN

Para enterrar



CÓDIGO	MEDIDA	€/100	Nº AGUJEROS	Ø ORIFICIOS	ESPESOR	UD. MIN. VENTA	
APEN71	71 x 71 x 750	3.092,917	2	4 x 11	1,8	2	1
APEN91	91 x 91 x 750	3.478,501	2	4 x 11	1,8	2	1

VM-PF Puntas de fijación ATLANTIS C3-M

VM-PF

Puntas de fijación galvanizadas en caliente

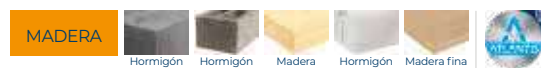

CÓDIGO	MEDIDA	€/100	
VMPF050	4 x 50	27,463	200



TORNILLERÍA NORMALIZADA



A PE

DIN-933

Tornillo rosca métrica con cabeza hexagonal 8.8. Rosca completa

DIN-933

METAL



Cincado

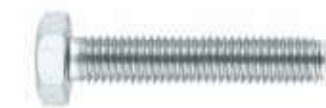

Disponible en varios recubrimientos. Consulte precio y plazo de entrega.

CÓDIGO	MEDIDA	€/100				CÓDIGO	MEDIDA	€/100			
D93304008	M4 x 8	3,967	7	500	22.500	D93310100	M10 x 100	106,623	17	50	300
D93304010	M4 x 10	4,137	7	500	22.500	D93312020	M12 x 20	45,797	19	100	1.200
D93304012	M4 x 12	4,483	7	500	12.000	D93312025	M12 x 25	50,390	19	100	600
D93304016	M4 x 16	5,037	7	500	12.000	D93312030	M12 x 30	55,183	19	100	600
D93304020	M4 x 20	5,547	7	500	12.000	D93312035	M12 x 35	57,463	19	100	600
D93304025	M4 x 25	6,397	7	500	6.000	D93312040	M12 x 40	65,737	19	100	600
D93304030	M4 x 30	7,313	7	500	6.000	D93312045	M12 x 45	73,290	19	100	600
D93304035	M4 x 35	7,841	7	250	6.000	D93312050	M12 x 50	75,617	19	100	400
D93304040	M4 x 40	9,853	7	250	3.000	D93312060	M12 x 60	84,963	19	100	400
D93304045	M4 x 45	11,020	7	250	3.000	D93312070	M12 x 70	98,937	19	100	400
D93304050	M4 x 50	12,077	7	250	3.000	D93312080	M12 x 80	116,303	19	50	300
D93304060	M4 x 60	17,250	7	250	3.000	D93312090	M12 x 90	135,420	19	50	300
D93305010	M5 x 10	5,227	8	500	12.000	D93312100	M12 x 100	147,820	19	25	300
D93305012	M5 x 12	5,517	8	500	12.000	D93312110	M12 x 110	168,183	19	25	300
D93305016	M5 x 16	6,124	8	500	6.000	D93312120	M12 x 120	191,483	19	25	300
D93305020	M5 x 20	6,832	8	500	6.000	D93314030	M14 x 30	94,019	22	50	400
D93305025	M5 x 25	7,135	8	500	6.000	D93314035	M14 x 35	105,420	22	50	300
D93305030	M5 x 30	8,673	8	500	6.000	D93314040	M14 x 40	112,820	22	50	300
D93305035	M5 x 35	9,153	8	250	3.000	D93314045	M14 x 45	119,430	22	50	300
D93305040	M5 x 40	9,877	8	250	3.000	D93314050	M14 x 50	128,193	22	50	300
D93305045	M5 x 45	10,863	8	250	3.000	D93314060	M14 x 60	140,857	22	50	300
D93305050	M5 x 50	12,025	8	250	3.000	D93314070	M14 x 70	167,393	22	50	300
D93305060	M5 x 60	15,910	8	250	1.500	D93314080	M14 x 80	182,227	22	25	150
D93305070	M5 x 70	22,336	8	250	3.000	D93314090	M14 x 90	187,813	22	25	150
D93306010	M6 x 10	6,698	10	250	6.000	D93314100	M14 x 100	190,210	22	25	150
D93306012	M6 x 12	7,017	10	250	6.000	D93314110	M14 x 110	220,803	22	25	150
D93306016	M6 x 16	7,927	10	250	6.000	D93314120	M14 x 120	256,473	22	25	150
D93306020	M6 x 20	8,925	10	250	3.000	D93316030	M16 x 30	114,767	24	50	300
D93306025	M6 x 25	9,706	10	250	3.000	D93316035	M16 x 35	130,197	24	50	300
D93306030	M6 x 30	10,950	10	250	3.000	D93316040	M16 x 40	134,233	24	50	300
D93306035	M6 x 35	12,356	10	250	3.000	D93316045	M16 x 45	154,163	24	50	300
D93306040	M6 x 40	14,490	10	250	3.000	D93316050	M16 x 50	154,627	24	50	300
D93306045	M6 x 45	15,970	10	250	1.500	D93316060	M16 x 60	172,720	24	50	200
D93306050	M6 x 50	17,420	10	250	1.500	D93316070	M16 x 70	213,583	24	25	150
D93306060	M6 x 60	19,353	10	100	1.200	D93316080	M16 x 80	220,300	24	25	150
D93306065	M6 x 65	20,453	10	100	600	D93316090	M16 x 90	234,323	24	25	150
D93306070	M6 x 70	22,420	10	100	1.200	D93316100	M16 x 100	253,820	24	25	150
D93308016	M8 x 16	16,690	13	200	2.400	D93316110	M16 x 110	263,087	24	25	150
D93308020	M8 x 20	17,487	13	200	1.600	D93316120	M16 x 120	366,823	24	25	150
D93308025	M8 x 25	21,020	13	200	1.600	D93318030	M18 x 30	193,480	27	25	150
D93308030	M8 x 30	22,233	13	200	1.200	D93318035	M18 x 35	212,883	27	25	300
D93308035	M8 x 35	24,340	13	200	1.200	D93318040	M18 x 40	226,653	27	25	300
D93308040	M8 x 40	25,554	13	200	1.200	D93318045	M18 x 45	235,677	27	25	300
D93308045	M8 x 45	26,549	13	200	1.200	D93318050	M18 x 50	245,143	27	25	150
D93308050	M8 x 50	29,067	13	200	800	D93318060	M18 x 60	273,343	27	25	150
D93308060	M8 x 60	33,910	13	200	800	D93318070	M18 x 70	303,027	27	25	150
D93308070	M8 x 70	42,480	13	200	800	D93318080	M18 x 80	326,100	27	25	150
D93308080	M8 x 80	52,763	13	100	600	D93318090	M18 x 90	412,747	27	25	150
D93308090	M8 x 90	59,723	13	100	600	D93318100	M18 x 100	417,010	27	25	150
D93308100	M8 x 100	65,663	13	100	400	D93318110	M18 x 110	458,410	27	25	100
D93308110	M8 x 110	85,677	13	100	400	D93318120	M18 x 120	565,377	27	25	100
D93308120	M8 x 120	86,210	13	100	400	D93320030	M20 x 30	205,867	30	25	150
D93310016	M10 x 16	29,150	17	200	1.200	D93320035	M20 x 35	227,839	30	25	150
D93310020	M10 x 20	31,733	17	200	1.200	D93320040	M20 x 40	268,660	30	25	150
D93310025	M10 x 25	37,567	17	200	1.200	D93320045	M20 x 45	256,507	30	25	150
D93310030	M10 x 30	39,557	17	200	800	D93320050	M20 x 50	268,160	30	25	150
D93310035	M10 x 35	42,100	17	200	1.200	D93320060	M20 x 60	308,837	30	25	150
D93310040	M10 x 40	45,923	17	200	800	D93320070	M20 x 70	359,773	30	25	100
D93310045	M10 x 45	47,280	17	200	800	D93320080	M20 x 80	394,787	30	10	120
D93310050	M10 x 50	52,963	17	200	800	D93320090	M20 x 90	451,780	30	10	60
D93310060	M10 x 60	64,996	17	100	600	D93320100	M20 x 100	522,027	30	10	60
D93310070	M10 x 70	66,180	17	100	400	D93320110	M20 x 110	682,120	30	10	60
D93310080	M10 x 80	77,110	17	100	400	D93320120	M20 x 120	711,900	30	10	60
D93310090	M10 x 90	96,930	17	50	300						



Tornillo rosca métrica con cabeza hexagonal 8.8. Rosca completa

DIN-933

Blíster

CÓDIGO	MEDIDA	€/BOLSA	PCS	BOLSAS
BZ3Z04008	M4 x 8	1,943	6	20
BZ3Z04010	M4 x 10	1,943	6	20
BZ3Z04012	M4 x 12	1,943	6	20
BZ3Z04016	M4 x 16	1,943	6	20
BZ3Z04020	M4 x 20	1,943	6	20
BZ3Z04025	M4 x 25	1,943	6	20
BZ3Z04030	M4 x 30	1,943	6	20
BZ3Z04035	M4 x 35	1,943	6	20
BZ3Z04040	M4 x 40	1,943	6	20
BZ3Z04045	M4 x 45	1,943	6	20
BZ3Z04050	M4 x 50	1,943	6	20
BZ3Z04060	M4 x 60	1,943	6	20
BZ3Z05010	M5 x 10	1,943	6	20
BZ3Z05012	M5 x 12	1,943	6	20
BZ3Z05015	M5 x 15	1,943	6	20
BZ3Z05016	M5 x 16	1,943	6	20
BZ3Z05020	M5 x 20	1,943	6	20
BZ3Z05025	M5 x 25	1,943	6	20
BZ3Z05030	M5 x 30	1,943	6	20
BZ3Z05035	M5 x 35	1,943	6	20
BZ3Z05040	M5 x 40	1,943	6	20
BZ3Z05045	M5 x 45	1,943	6	20
BZ3Z05050	M5 x 50	1,943	6	20
BZ3Z05060	M5 x 60	1,943	6	20
BZ3Z06016	M6 x 16	1,943	6	20
BZ3Z06020	M6 x 20	1,943	6	20
BZ3Z06025	M6 x 25	1,943	6	20
BZ3Z06030	M6 x 30	1,943	6	20
BZ3Z06040	M6 x 40	1,943	6	20
BZ3Z06050	M6 x 50	1,943	6	20
BZ3Z06060	M6 x 60	1,943	4	20
BZ3Z06070	M6 x 70	1,943	4	20
BZ3Z08016	M8 x 16	1,943	4	20
BZ3Z08020	M8 x 20	1,943	4	20
BZ3Z08025	M8 x 25	1,943	4	20
BZ3Z08030	M8 x 30	1,943	4	20
BZ3Z08040	M8 x 40	1,943	4	20
BZ3Z08050	M8 x 50	1,943	4	20
BZ3Z08060	M8 x 60	1,943	4	20
BZ3Z08070	M8 x 70	1,943	4	20
BZ3Z08080	M8 x 80	1,943	4	20
BZ3Z10030	M10 x 30	1,943	2	20
BZ3Z10040	M10 x 40	1,943	2	20
BZ3Z10050	M10 x 50	1,943	2	20

Caja ventana

CÓDIGO	MEDIDA	€/CAJA	PCS	CAJAS
VD93304008	M4 x 8	5,025	100	8
VD93304010	M4 x 10	5,238	100	8
VD93304012	M4 x 12	5,508	100	8
VD93304016	M4 x 16	5,877	100	8
VD93304020	M4 x 20	6,769	100	8
VD93304025	M4 x 25	6,291	80	8
VD93304030	M4 x 30	6,884	80	8
VD93304040	M4 x 40	5,599	50	8
VD93304050	M4 x 50	5,768	40	8
VD93304060	M4 x 60	8,537	40	8
VD93305010	M5 x 10	6,141	100	8
VD93305012	M5 x 12	5,188	80	8
VD93305016	M5 x 16	5,852	80	8
VD93305020	M5 x 20	5,710	70	8
VD93305025	M5 x 25	5,574	60	8
VD93305030	M5 x 30	4,466	40	8
VD93305040	M5 x 40	4,419	30	8
VD93305050	M5 x 50	3,529	15	8
VD93305060	M5 x 60	3,948	15	8
VD93305070	M5 x 70	3,640	10	8
VD93306016	M6 x 16	5,222	50	8
VD93306020	M6 x 20	5,627	50	8
VD93306025	M6 x 25	5,225	45	8
VD93306030	M6 x 30	5,341	40	8
VD93306040	M6 x 40	5,196	30	8
VD93306050	M6 x 50	4,197	15	8
VD93306060	M6 x 60	4,090	15	8
VD93306070	M6 x 70	4,804	15	8
VD93308016	M8 x 16	7,888	40	8
VD93308020	M8 x 20	7,443	35	8
VD93308025	M8 x 25	7,204	30	8
VD93308030	M8 x 30	6,734	25	8
VD93308040	M8 x 40	5,999	20	8
VD93308050	M8 x 50	5,247	15	8
VD93308060	M8 x 60	6,301	15	8
VD93308070	M8 x 70	7,847	15	8
VD93308080	M8 x 80	6,580	10	8
VD93308100	M8 x 100	8,763	10	8
VD93310020	M10 x 20	5,846	15	8
VD93310030	M10 x 30	7,057	15	8
VD93310040	M10 x 40	5,687	10	8
VD93310050	M10 x 50	6,451	10	8
VD93310060	M10 x 60	7,562	10	8
VD93310070	M10 x 70	7,904	10	8
VD93310080	M10 x 80	9,208	10	8
VD93312030	M12 x 30	6,744	10	8
VD93312040	M12 x 40	6,731	8	8
VD93312050	M12 x 50	5,554	6	8
VD93312060	M12 x 60	6,160	6	8
VD93312070	M12 x 70	7,038	6	8
VD93312080	M12 x 80	8,396	6	8

DIN-933

Zincado



Disponible en varios recubrimientos. Consulte precio y plazo de entrega.

DIN-933

Tornillo rosca métrica con cabeza hexagonal 8.8. Rosca completa

DIN-933 A2

INOXIDABLE



Inoxidable A2

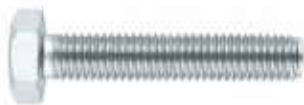

CÓDIGO	MEDIDA	€/100				CÓDIGO	MEDIDA	€/100			
D933IM04010	M4 x 10	10,103	7	500	12.000	D933IM10040	M10 x 40	96,259	17	200	-
D933IM04016	M4 x 16	12,100	7	500	12.000	D933IM10050	M10 x 50	111,160	17	200	-
D933IM04020	M4 x 20	13,920	7	500	8.000	D933IM10060	M10 x 60	127,297	17	100	600
D933IM04025	M4 x 25	15,017	7	500	8.000	D933IM10070	M10 x 70	143,590	17	100	400
D933IM04030	M4 x 30	17,590	7	500	6.000	D933IM10080	M10 x 80	168,953	17	100	400
D933IM04035	M4 x 35	21,110	7	250	6.000	D933IM10090	M10 x 90	190,347	17	50	300
D933IM04040	M4 x 40	23,470	7	250	6.000	D933IM10100	M10 x 100	214,773	17	50	300
D933IM05010	M5 x 10	10,553	8	500	8.000	D933IM12020	M12 x 20	115,770	19	100	600
D933IM05016	M5 x 16	12,373	8	500	-	D933IM12030	M12 x 30	120,420	19	100	600
D933IM05020	M5 x 20	14,013	8	500	6.000	D933IM12040	M12 x 40	139,996	19	100	400
D933IM05025	M5 x 25	16,614	8	500	4.000	D933IM12050	M12 x 50	161,560	19	100	400
D933IM05030	M5 x 30	19,241	8	500	4.000	D933IM12060	M12 x 60	184,142	19	100	400
D933IM05035	M5 x 35	20,657	8	250	3.000	D933IM12070	M12 x 70	206,963	19	100	-
D933IM05040	M5 x 40	23,203	8	250	3.000	D933IM12080	M12 x 80	250,677	19	50	300
D933IM05050	M5 x 50	28,393	8	250	3.000	D933IM12090	M12 x 90	274,450	19	50	300
D933IM06010	M6 x 10	17,703	10	250	6.000	D933IM12100	M12 x 100	298,230	19	25	150
D933IM06016	M6 x 16	18,757	10	250	4.000	D933IM14030	M14 x 30	226,913	22	50	300
D933IM06020	M6 x 20	21,730	10	250	4.000	D933IM14040	M14 x 40	248,520	22	50	300
D933IM06025	M6 x 25	22,580	10	250	3.000	D933IM14050	M14 x 50	283,100	22	50	300
D933IM06030	M6 x 30	26,233	10	250	3.000	D933IM14060	M14 x 60	321,997	22	50	200
D933IM06035	M6 x 35	29,667	10	250	2.000	D933IM14070	M14 x 70	358,733	22	50	200
D933IM06040	M6 x 40	32,790	10	250	2.000	D933IM14080	M14 x 80	385,333	22	25	150
D933IM06050	M6 x 50	38,913	10	250	1.500	D933IM14100	M14 x 100	528,510	22	25	150
D933IM08016	M8 x 16	34,613	13	200	1.600	D933IM16030	M16 x 30	250,570	24	50	300
D933IM08020	M8 x 20	37,520	13	200	1.600	D933IM16040	M16 x 40	266,063	24	50	200
D933IM08025	M8 x 25	42,353	13	200	1.600	D933IM16050	M16 x 50	306,067	24	50	200
D933IM08030	M8 x 30	47,090	13	200	1.200	D933IM16060	M16 x 60	348,204	24	50	200
D933IM08035	M8 x 35	51,813	13	200	1.200	D933IM16070	M16 x 70	388,122	24	25	150
D933IM08040	M8 x 40	57,193	13	200	1.200	D933IM16080	M16 x 80	444,530	24	25	150
D933IM08050	M8 x 50	68,820	13	200	800	D933IM16090	M16 x 90	492,203	24	25	150
D933IM08060	M8 x 60	78,547	13	200	800	D933IM16100	M16 x 100	533,173	24	25	100
D933IM08070	M8 x 70	94,123	13	200	800	D933IM18030	M18 x 30	500,940	27	25	100
D933IM08080	M8 x 80	107,577	13	100	600	D933IM18040	M18 x 40	529,820	27	25	200
D933IM08090	M8 x 90	119,190	13	100	600	D933IM18050	M18 x 50	578,760	27	25	150
D933IM08100	M8 x 100	133,730	13	100	600	D933IM18060	M18 x 60	646,843	27	25	150
D933IM10020	M10 x 20	70,523	17	200	800	D933IM18070	M18 x 70	719,170	27	25	100
D933IM10025	M10 x 25	73,960	17	200	800	D933IM18080	M18 x 80	787,273	27	25	100
D933IM10030	M10 x 30	83,610	17	200	800	D933IM18090	M18 x 90	855,367	27	25	100
D933IM10035	M10 x 35	91,153	17	200	800	D933IM18100	M18 x 100	923,457	27	25	100

Blíster

CÓDIGO	MEDIDA	€/BOLSA	PCS	BOLSAS
BZ3I04010	M4 x 10	2,459	6	20
BZ3I04016	M4 x 16	2,459	6	20
BZ3I04020	M4 x 20	2,459	6	20
BZ3I04030	M4 x 30	2,459	6	20
BZ3I04040	M4 x 40	2,459	6	20
BZ3I05010	M5 x 10	2,459	6	20
BZ3I05016	M5 x 16	2,459	6	20
BZ3I05020	M5 x 20	2,459	6	20
BZ3I05030	M5 x 30	2,459	6	20
BZ3I05040	M5 x 40	2,459	6	20
BZ3I05050	M5 x 50	2,459	6	20
BZ3I06016	M6 x 16	2,459	6	20
BZ3I06020	M6 x 20	2,459	6	20
BZ3I06025	M6 x 25	2,459	6	20
BZ3I06030	M6 x 30	2,459	6	20
BZ3I06040	M6 x 40	2,459	6	20
BZ3I06050	M6 x 50	2,459	6	20
BZ3I08016	M8 x 16	2,459	4	20
BZ3I08020	M8 x 20	2,459	4	20
BZ3I08025	M8 x 25	2,459	4	20
BZ3I08030	M8 x 30	2,459	4	20
BZ3I08040	M8 x 40	2,459	4	20
BZ3I08050	M8 x 50	2,459	4	20
BZ3I08060	M8 x 60	2,459	4	20
BZ3I10020	M10 x 20	2,459	2	20
BZ3I10030	M10 x 30	2,459	2	20
BZ3I10040	M10 x 40	2,459	2	20

Caja ventana

CÓDIGO	MEDIDA	€/CAJA	PCS	CAJAS
VD933I04010	M4 x 10	5,313	40	8
VD933I04016	M4 x 16	6,363	40	8
VD933I04020	M4 x 20	7,055	40	8
VD933I04030	M4 x 30	6,783	30	8
VD933I04040	M4 x 40	7,433	25	8
VD933I05010	M5 x 10	5,551	40	8
VD933I05016	M5 x 16	6,509	40	8
VD933I05020	M5 x 20	7,369	40	8
VD933I05030	M5 x 30	4,905	20	8
VD933I05040	M5 x 40	6,101	20	8
VD933I05050	M5 x 50	3,919	10	8
VD933I06010	M6 x 10	6,987	30	8
VD933I06016	M6 x 16	7,123	30	8
VD933I06020	M6 x 20	8,255	30	8
VD933I06025	M6 x 25	7,146	25	8
VD933I06030	M6 x 30	8,306	25	8
VD933I06040	M6 x 40	6,470	15	8
VD933I06050	M6 x 50	5,115	10	8
VD933I08016	M8 x 16	9,105	20	8
VD933I08020	M8 x 20	9,865	20	8
VD933I08025	M8 x 25	11,139	20	8
VD933I08030	M8 x 30	9,290	15	8
VD933I08040	M8 x 40	7,520	10	8
VD933I08050	M8 x 50	9,047	10	8
VD933I08060	M8 x 60	10,328	10	8
VD933I10020	M10 x 20	9,273	10	8
VD933I10030	M10 x 30	10,657	10	8

Caja ventana

CÓDIGO	MEDIDA	€/CAJA	PCS	CAJAS
VD933I10040	M10 x 40	12,271	10	8
VD933I10050	M10 x 50	14,615	10	8
VD933I10060	M10 x 60	17,257	10	8



Tornillo rosca métrica con cabeza hexagonal 8.8. Rosca media

DIN-931

METAL



Disponible en varios recubrimientos. Consulte precio y plazo de entrega.

CÓDIGO	MEDIDA	€/100			
D931806030	M6 x 30	11,104	10	250	3.000
D931806035	M6 x 35	12,823	10	250	2.000
D931806040	M6 x 40	13,901	10	250	2.000
D931806045	M6 x 45	15,487	10	250	2.000
D931806050	M6 x 50	16,430	10	250	1.500
D931806060	M6 x 60	19,980	10	100	1.200
D931806070	M6 x 70	24,743	10	100	1.200
D931808030	M8 x 30	21,603	13	200	1.200
D931808035	M8 x 35	22,863	13	200	1.200
D931808040	M8 x 40	25,060	13	200	1.200
D931808045	M8 x 45	29,603	13	200	1.200
D931808050	M8 x 50	30,308	13	250	1.000
D931808060	M8 x 60	36,177	13	250	-
D931808070	M8 x 70	42,433	13	250	-
D931808080	M8 x 80	54,137	13	100	600
D931808090	M8 x 90	64,157	13	100	600
D931808100	M8 x 100	69,100	13	100	600
D931808110	M8 x 110	74,060	13	100	400
D931808120	M8 x 120	83,933	13	100	400
D931808130	M8 x 130	92,500	13	50	400
D931808140	M8 x 140	103,687	13	50	400
D931808150	M8 x 150	105,940	13	50	400
D931810035	M10 x 35	42,340	17	200	800
D931810040	M10 x 40	43,590	17	200	-
D931810045	M10 x 45	46,330	17	200	-
D931810050	M10 x 50	57,340	17	200	-
D931810060	M10 x 60	61,007	17	100	600
D931810070	M10 x 70	68,050	17	100	400
D931810080	M10 x 80	78,473	17	100	400
D931810090	M10 x 90	89,747	17	50	300
D931810100	M10 x 100	99,683	17	50	300
D931810110	M10 x 110	118,726	17	50	300
D931810120	M10 x 120	124,464	17	50	300
D931810130	M10 x 130	137,183	17	50	200
D931810140	M10 x 140	140,527	17	50	200
D931810150	M10 x 150	152,550	17	25	200
D931812040	M12 x 40	61,763	19	100	400
D931812045	M12 x 45	70,387	19	100	400
D931812050	M12 x 50	78,057	19	100	400
D931812060	M12 x 60	82,673	19	100	400
D931812070	M12 x 70	94,897	19	100	400
D931812080	M12 x 80	117,657	19	50	300
D931812090	M12 x 90	129,183	19	50	200
D931812100	M12 x 100	130,233	19	25	200
D931812110	M12 x 110	165,130	19	25	200
D931812120	M12 x 120	163,693	19	25	200

CÓDIGO	MEDIDA	€/100			
D931812130	M12 x 130	184,536	19	25	200
D931812140	M12 x 140	191,712	19	25	-
D931812150	M12 x 150	199,023	19	10	120
D931814050	M14 x 50	127,303	22	50	300
D931814060	M14 x 60	144,583	22	50	200
D931814070	M14 x 70	153,650	22	50	200
D931814080	M14 x 80	168,227	22	25	150
D931814090	M14 x 90	190,087	22	25	150
D931814100	M14 x 100	219,413	22	25	150
D931814110	M14 x 110	240,773	22	25	150
D931814120	M14 x 120	260,220	22	25	150
D931814130	M14 x 130	280,737	22	25	100
D931814140	M14 x 140	287,263	22	25	100
D931814150	M14 x 150	313,215	22	10	120
D931816050	M16 x 50	144,683	24	50	200
D931816060	M16 x 60	162,040	24	50	200
D931816070	M16 x 70	183,720	24	25	150
D931816080	M16 x 80	211,577	24	25	150
D931816090	M16 x 90	213,060	24	25	150
D931816100	M16 x 100	268,800	24	25	100
D931816110	M16 x 110	272,973	24	25	100
D931816120	M16 x 120	345,377	24	25	100
D931816130	M16 x 130	307,853	24	25	100
D931816140	M16 x 140	323,777	24	25	100
D931816150	M16 x 150	350,743	24	10	80
D931818060	M18 x 60	290,353	27	25	150
D931818070	M18 x 70	302,447	27	25	100
D931818080	M18 x 80	341,633	27	25	100
D931818090	M18 x 90	340,360	27	25	100
D931818100	M18 x 100	381,997	27	25	100
D931818110	M18 x 110	393,650	27	10	80
D931818120	M18 x 120	464,710	27	10	80
D931818130	M18 x 130	552,190	27	10	80
D931818140	M18 x 140	607,113	27	10	80
D931818150	M18 x 150	666,700	27	10	-
D931820060	M20 x 60	299,877	30	25	100
D931820070	M20 x 70	332,143	30	25	100
D931820080	M20 x 80	369,930	30	25	100
D931820090	M20 x 90	444,267	30	25	100
D931820100	M20 x 100	496,517	30	25	-
D931820110	M20 x 110	586,427	30	10	-
D931820120	M20 x 120	632,246	30	10	-
D931820130	M20 x 130	638,186	30	10	-
D931820140	M20 x 140	672,672	30	10	60
D931820150	M20 x 150	715,968	30	5	30

Blíster

CÓDIGO	MEDIDA	€/BOLSA	PCS	BOLSAS
BZ93106030	M6 x 30	1,943	6	20
BZ93106040	M6 x 40	1,943	6	20
BZ93106050	M6 x 50	1,943	6	20
BZ93106060	M6 x 60	1,943	4	20
BZ93106070	M6 x 70	1,943	4	20
BZ93108030	M8 x 30	1,943	4	20
BZ93108040	M8 x 40	1,943	4	20
BZ93108050	M8 x 50	1,943	4	20
BZ93108060	M8 x 60	1,943	4	20
BZ93108070	M8 x 70	1,943	4	20
BZ93108080	M8 x 80	1,943	4	20

Caja ventana

CÓDIGO	MEDIDA	€/CAJA	PCS	CAJAS
VD93106030	M6 x 30	5,947	40	8
VD93106040	M6 x 40	5,671	30	8
VD93106050	M6 x 50	3,757	15	8
VD93106060	M6 x 60	4,202	15	8
VD93106070	M6 x 70	5,000	15	8
VD93108030	M8 x 30	7,130	25	8
VD93108040	M8 x 40	6,198	20	8
VD93108050	M8 x 50	5,449	15	8
VD93108060	M8 x 60	6,555	15	8
VD93108070	M8 x 70	7,870	15	8
VD93108080	M8 x 80	6,914	10	8
VD93110040	M10 x 40	5,723	10	8
VD93110050	M10 x 50	7,093	10	8
VD93110060	M10 x 60	7,219	10	8
VD93110070	M10 x 70	8,217	10	8
VD93110080	M10 x 80	9,688	10	8
VD93112050	M12 x 50	5,915	6	8
VD93112060	M12 x 60	6,388	6	8
VD93112070	M12 x 70	7,189	6	8
VD93112080	M12 x 80	8,715	6	8

DIN-6921

Tornillo cabeza hexagonal con arandela estampada y grafilada 8.8

DIN-6921

METAL



Cincado



Disponible en varios recubrimientos. Consulte precio y plazo de entrega.

CÓDIGO	MEDIDA	€/100			
D692105010	M5 x 10	10,123	8	500	6.000
D692105012	M5 x 12	10,300	8	500	4.000
D692105016	M5 x 16	11,307	8	500	4.000
D692105020	M5 x 20	11,600	8	500	3.000
D692105025	M5 x 25	13,903	8	500	3.000
D692105030	M5 x 30	16,470	8	500	3.000
D692106010	M6 x 10	14,960	10	250	-
D692106012	M6 x 12	14,950	10	250	3.000
D692106016	M6 x 16	15,937	10	250	3.000
D692106020	M6 x 20	16,930	10	250	3.000
D692106025	M6 x 25	18,927	10	250	2.000
D692106030	M6 x 30	21,963	10	250	2.000
D692106035	M6 x 35	22,427	10	250	1.500
D692108012	M8 x 12	27,193	13	200	1.600
D692108016	M8 x 16	28,270	13	200	1.600
D692108020	M8 x 20	28,877	13	200	-
D692108025	M8 x 25	35,410	13	200	-
D692108030	M8 x 30	37,383	13	200	1.200
D692108035	M8 x 35	42,913	13	200	1.200
D692108040	M8 x 40	43,260	13	200	800
D692108050	M8 x 50	47,197	13	200	800
D692108060	M8 x 60	52,237	13	200	600
D692110020	M10 x 20	53,523	15	200	800
D692110025	M10 x 25	55,523	15	200	800
D692110030	M10 x 30	60,430	15	200	800
D692110035	M10 x 35	64,403	15	200	-
D692110040	M10 x 40	74,183	15	200	-
D692110050	M10 x 50	85,337	15	200	-
D692112025	M12 x 25	86,990	16	100	400
D692112030	M12 x 30	93,540	16	100	400
D692112035	M12 x 35	102,033	16	100	400
D692112040	M12 x 40	103,500	16	100	400
D692112045	M12 x 45	116,650	16	100	400
D692112050	M12 x 50	120,240	16	100	-
D692112060	M12 x 60	136,967	16	100	-

DIN-6921 A2

Tornillo DIN-6921. Tornillo hexagonal con arandela estampada y grafilada. Inoxidable A2

METAL



CÓDIGO	MEDIDA	€/100	LLAVE DE INSTALACIÓN			
692108020	M8 x 20	50,523	13	200	2.400	
692108050	M8 x 50	80,817	13	100	600	
692108070	M8 x 70	117,303	13	100	600	



Tornillo rosca métrica con cabeza Allen 8.8

DIN-912

METAL



CÓDIGO	MEDIDA	€/100			
D91204008	M4 x 8	5,923	3	500	22.500
D91204010	M4 x 10	6,037	3	500	12.000
D91204012	M4 x 12	7,673	3	500	12.000
D91204016	M4 x 16	7,940	3	500	12.000
D91204020	M4 x 20	8,140	3	500	6.000
D91204025	M4 x 25	9,156	3	500	6.000
D91204030	M4 x 30	10,528	3	500	6.000
D91204035	M4 x 35	11,820	3	200	4.800
D91204040	M4 x 40	13,117	3	200	2.400
D91204045	M4 x 45	15,621	3	200	2.400
D91204050	M4 x 50	15,533	3	200	2.400
D91205008	M5 x 8	8,136	4	500	12.000
D91205010	M5 x 10	7,533	4	500	12.000
D91205012	M5 x 12	7,567	4	500	6.000
D91205016	M5 x 16	7,713	4	500	6.000
D91205020	M5 x 20	7,820	4	500	6.000
D91205025	M5 x 25	9,893	4	500	6.000
D91205030	M5 x 30	11,290	4	500	6.000
D91205035	M5 x 35	13,567	4	200	4.800
D91205040	M5 x 40	13,950	4	200	2.400
D91205045	M5 x 45	14,340	4	200	2.400
D91205050	M5 x 50	15,193	4	200	2.400
D91206010	M6 x 10	10,190	5	200	4.800
D91206012	M6 x 12	10,897	5	200	4.800
D91206016	M6 x 16	11,041	5	200	4.800
D91206020	M6 x 20	11,417	5	200	2.400
D91206025	M6 x 25	13,806	5	200	2.400
D91206030	M6 x 30	15,268	5	200	2.400
D91206035	M6 x 35	16,121	5	200	2.400
D91206040	M6 x 40	19,134	5	200	2.400
D91206045	M6 x 45	21,534	5	200	2.400
D91206050	M6 x 50	21,771	5	200	2.400
D91206060	M6 x 60	22,540	5	200	1.200
D91208010	M8 x 10	17,960	6	100	2.400
D91208012	M8 x 12	18,663	6	100	2.400
D91208016	M8 x 16	19,933	6	100	2.400
D91208020	M8 x 20	19,921	6	100	2.400

CÓDIGO	MEDIDA	€/100			
D91208025	M8 x 25	22,426	6	100	1.200
D91208030	M8 x 30	26,901	6	100	1.200
D91208035	M8 x 35	29,255	6	100	1.200
D91208040	M8 x 40	37,277	6	100	1.200
D91208045	M8 x 45	37,229	6	100	1.200
D91208050	M8 x 50	43,585	6	100	1.200
D91208060	M8 x 60	40,064	6	100	1.200
D91208070	M8 x 70	47,280	6	100	600
D91208080	M8 x 80	54,743	6	100	600
D91210016	M10 x 16	38,713	8	100	1.200
D91210020	M10 x 20	43,446	8	100	1.200
D91210025	M10 x 25	47,808	8	100	1.200
D91210030	M10 x 30	50,068	8	100	1.200
D91210035	M10 x 35	54,705	8	100	600
D91210040	M10 x 40	64,867	8	100	600
D91210045	M10 x 45	69,019	8	100	600
D91210050	M10 x 50	83,494	8	100	600
D91210060	M10 x 60	76,801	8	100	600
D91210070	M10 x 70	83,426	8	100	600
D91210080	M10 x 80	92,195	8	50	600
D91210090	M10 x 90	100,127	8	50	300
D91210100	M10 x 100	108,980	8	50	300
D91212020	M12 x 20	61,663	10	100	600
D91212025	M12 x 25	68,682	10	100	600
D91212030	M12 x 30	68,130	10	100	600
D91212035	M12 x 35	75,356	10	100	600
D91212040	M12 x 40	77,794	10	100	600
D91212045	M12 x 45	79,960	10	100	600
D91212050	M12 x 50	91,920	10	50	600
D91212060	M12 x 60	102,060	10	50	300
D91212070	M12 x 70	121,648	10	50	300
D91212080	M12 x 80	133,951	10	50	300
D91212090	M12 x 90	150,696	10	50	300
D91212100	M12 x 100	168,777	10	50	300
D91212110	M12 x 110	193,230	10	50	300
D91212120	M12 x 120	216,137	10	50	300



Disponible en varios recubrimientos. Consulte precio y plazo de entrega.

Caja ventana

CÓDIGO	MEDIDA	€/CAJA	PCS	CAJAS
VD91204010	M4 x 10	10,849	150	8
VD91204012	M4 x 12	11,866	125	8
VD91204020	M4 x 20	9,860	100	8
VD91204030	M4 x 30	5,455	40	8
VD91204040	M4 x 40	3,867	20	8
VD91204050	M4 x 50	5,756	20	8
VD91205010	M5 x 10	9,393	100	8
VD91205012	M5 x 12	9,489	100	8
VD91205016	M5 x 16	8,033	90	8
VD91205020	M5 x 20	6,816	70	8
VD91205025	M5 x 25	7,194	60	8
VD91205030	M5 x 30	6,119	40	8
VD91205040	M5 x 40	4,030	20	8
VD91205050	M5 x 50	4,341	20	8
VD91206010	M6 x 10	6,392	50	8
VD91206012	M6 x 12	6,965	50	8
VD91206016	M6 x 16	6,097	50	8
VD91206020	M6 x 20	6,914	50	8
VD91206025	M6 x 25	10,456	50	8
VD91206030	M6 x 30	7,419	35	8
VD91206040	M6 x 40	7,043	30	8
VD91206050	M6 x 50	4,446	15	8
VD91206060	M6 x 60	4,814	15	8
VD91208010	M8 x 10	6,905	30	8
VD91208016	M8 x 16	7,598	30	8
VD91208020	M8 x 20	7,321	30	8
VD91208030	M8 x 30	6,591	20	8
VD91208040	M8 x 40	10,124	20	8
VD91208050	M8 x 50	5,505	10	8
VD91208060	M8 x 60	5,766	10	8

DIN-603/934 Tornillo con cabeza redonda con cuello cuadrado y tuerca hexagonal

METAL



CÓDIGO	MEDIDA	€/100				CÓDIGO	MEDIDA	€/100			
D603905016	M5 x 16	8,760	PC5	500	6.000	D603908120	M8 x 120	71,047	PC8	50	300
D603905020	M5 x 20	9,027	PC5	500	3.000	D603908130	M8 x 130	77,223	PC8	50	300
D603905025	M5 x 25	10,157	PC5	500	3.000	D603908140	M8 x 140	85,510	PC8	50	300
D603905030	M5 x 30	10,303	PC5	500	3.000	D603908150	M8 x 150	92,587	PC8	50	300
D603905035	M5 x 35	13,367	PC5	200	2.400	D603910020	M10 x 20	45,257	PC10	100	600
D603905040	M5 x 40	14,333	PC5	200	2.400	D603910025	M10 x 25	45,950	PC10	100	600
D603905045	M5 x 45	15,767	PC5	200	2.400	D603910030	M10 x 30	58,173	PC10	100	600
D603905050	M5 x 50	17,463	PC5	200	2.400	D603910035	M10 x 35	60,557	PC10	100	600
D603905060	M5 x 60	20,743	PC5	100	1.200	D603910040	M10 x 40	61,547	PC10	100	600
D603905070	M5 x 70	22,750	PC5	100	1.200	D603910045	M10 x 45	65,723	PC10	100	600
D603905080	M5 x 80	27,270	PC5	100	1.200	D603910050	M10 x 50	66,723	PC10	100	600
D603906016	M6 x 16	12,837	PC5	200	2.400	D603910060	M10 x 60	79,607	PC10	50	300
D603906020	M6 x 20	13,730	PC6	200	2.400	D603910070	M10 x 70	86,367	PC10	50	300
D603906025	M6 x 25	14,947	PC6	200	2.400	D603910080	M10 x 80	97,860	PC10	50	300
D603906030	M6 x 30	16,477	PC6	200	1.200	D603910090	M10 x 90	106,433	PC10	50	300
D603906035	M6 x 35	17,040	PC6	200	2.400	D603910100	M10 x 100	111,680	PC10	50	300
D603906040	M6 x 40	17,633	PC6	200	1.200	D603910110	M10 x 110	126,093	PC10	25	300
D603906045	M6 x 45	19,223	PC6	200	1.200	D603910120	M10 x 120	133,800	PC10	25	300
D603906050	M6 x 50	20,773	PC6	200	1.200	D603910130	M10 x 130	146,477	PC10	25	150
D603906060	M6 x 60	23,930	PC6	100	1.200	D603910140	M10 x 140	155,773	PC10	25	150
D603906070	M6 x 70	29,723	PC6	100	1.200	D603910150	M10 x 150	169,600	PC10	25	150
D603906080	M6 x 80	31,427	PC6	100	600	D603910160	M10 x 160	177,400	PC10	25	100
D603906090	M6 x 90	44,577	PC6	100	600	D603910180	M10 x 180	206,347	PC10	25	100
D603906100	M6 x 100	47,847	PC6	100	600	D603910200	M10 x 200	218,030	PC10	25	75
D603906110	M6 x 110	55,020	PC6	100	600	D603912030	M12 x 30	94,363	PC12	50	300
D603906120	M6 x 120	60,137	PC6	100	600	D603912035	M12 x 35	99,403	PC12	50	300
D603906130	M6 x 130	66,150	PC6	100	600	D603912040	M12 x 40	110,587	PC12	50	300
D603906140	M6 x 140	77,087	PC6	100	600	D603912045	M12 x 45	114,230	PC12	50	300
D603906150	M6 x 150	81,757	PC6	100	600	D603912050	M12 x 50	120,183	PC12	50	300
D603908016	M8 x 16	23,930	PC8	200	1.200	D603912060	M12 x 60	136,770	PC12	25	300
D603908020	M8 x 20	25,247	PC8	200	1.200	D603912070	M12 x 70	178,070	PC12	25	300
D603908025	M8 x 25	25,390	PC8	200	1.200	D603912080	M12 x 80	179,350	PC12	25	150
D603908030	M8 x 30	27,820	PC8	200	1.200	D603912100	M12 x 100	187,393	PC12	25	150
D603908035	M8 x 35	29,003	PC8	200	1.200	D603912120	M12 x 120	206,310	PC12	25	150
D603908040	M8 x 40	30,157	PC8	200	1.200	D603912140	M12 x 140	232,523	PC12	25	150
D603908045	M8 x 45	37,293	PC8	200	1.200	D603912160	M12 x 160	279,110	PC12	25	100
D603908050	M8 x 50	39,043	PC8	100	1.200	D603912180	M12 x 180	297,800	PC12	25	100
D603908060	M8 x 60	42,437	PC8	100	600	D603912200	M12 x 200	310,480	PC12	10	40
D603908070	M8 x 70	45,310	PC8	100	600	D603912220	M12 x 220	378,687	PC12	10	30
D603908080	M8 x 80	54,013	PC8	100	400	D603912240	M12 x 240	480,543	PC12	10	30
D603908090	M8 x 90	64,430	PC8	100	600	D603912260	M12 x 260	496,047	PC12	10	20
D603908100	M8 x 100	67,910	PC8	100	600	D603912280	M12 x 280	515,013	PC12	10	20
D603908110	M8 x 110	69,217	PC8	50	300	D603912300	M12 x 300	571,780	PC12	10	20

Blíster

CÓDIGO	MEDIDA	€/BOLSA	PCS	BOLSAS
BZ603905020	M5 x 20	2,459	10	15
BZ603905030	M5 x 30	2,459	10	15
BZ603905040	M5 x 40	2,459	4	15
BZ603905050	M5 x 50	2,459	4	15
BZ603906016	M6 x 16	2,459	4	15
BZ603906020	M6 x 20	2,459	4	15
BZ603906030	M6 x 30	2,459	4	15
BZ603906040	M6 x 40	2,459	4	15
BZ603906050	M6 x 50	2,459	4	15
BZ603906060	M6 x 60	2,459	2	15
BZ603906070	M6 x 70	2,459	2	15
BZ603906080	M6 x 80	2,459	2	15
BZ603908025	M8 x 25	2,459	4	15
BZ603908030	M8 x 30	2,459	4	15
BZ603908040	M8 x 40	2,459	4	15
BZ603908050	M8 x 50	2,459	2	15
BZ603908060	M8 x 60	2,459	2	15
BZ603908070	M8 x 70	2,459	2	15
BZ603908080	M8 x 80	2,459	2	12
BZ603908090	M8 x 90	2,459	2	12
BZ603910025	M10 x 25	2,459	2	10
BZ603910030	M10 x 30	2,459	2	10
BZ603910040	M10 x 40	2,459	2	10
BZ603910050	M10 x 50	2,459	2	10

Caja ventana

CÓDIGO	MEDIDA	€/CAJA	PCS	CAJAS
VD603905020	M5 x 20	5,842	50	8
VD603905030	M5 x 30	5,862	40	8
VD603905040	M5 x 40	6,933	40	8
VD603905050	M5 x 50	7,832	35	8
VD603906016	M6 x 16	4,804	30	8
VD603906020	M6 x 20	5,332	30	8
VD603906030	M6 x 30	5,847	30	8
VD603906040	M6 x 40	5,843	25	8
VD603906050	M6 x 50	6,712	25	8
VD603906060	M6 x 60	7,505	25	8
VD603906070	M6 x 70	9,406	25	8
VD603906080	M6 x 80	7,544	20	8
VD603908025	M8 x 25	5,769	15	8
VD603908030	M8 x 30	5,956	15	8
VD603908040	M8 x 40	5,796	15	8
VD603908050	M8 x 50	7,270	15	8
VD603908060	M8 x 60	6,527	12	8
VD603908070	M8 x 70	6,167	10	8
VD603908080	M8 x 80	6,913	10	8
VD603908090	M8 x 90	8,333	10	8
VD603908100	M8 x 100	8,364	10	8
VD603910025	M10 x 25	8,559	15	8
VD603910030	M10 x 30	7,449	10	8
VD603910040	M10 x 40	7,731	10	8
VD603910050	M10 x 50	7,847	8	8
VD603910060	M10 x 60	8,967	8	8
VD603910070	M10 x 70	9,268	8	8
VD603910080	M10 x 80	10,563	8	8



Tornillo con cabeza redonda y cuello cuadrado. Inoxidable A2

DIN-603 A2

METAL



CÓDIGO	MEDIDA	€/100		
D603I08016	M8 x 16	42,047	200	2.400



Disponible en varios recubrimientos. Consulte precio y plazo de entrega.

Tornillo arado con cabeza avellanada 8.8. Con tuerca

DIN-608

METAL



CÓDIGO	MEDIDA	€/100		
D60810035	10 x 35	51,730	100	600
D60810040	10 x 40	53,370	100	600
D60810045	10 x 45	58,877	100	600
D60810050	10 x 50	62,687	100	400
D60810060	10 x 60	73,490	100	400
D60811040	11 x 40	60,357	50	300
D60811045	11 x 45	66,500	50	300
D60811050	11 x 50	74,575	50	300
D60811060	11 x 60	83,117	50	300
D60811070	11 x 70	93,230	50	300
D60811080	11 x 80	105,257	50	200
D60811090	11 x 90	123,193	50	200

CÓDIGO	MEDIDA	€/100		
D60812040	12 x 40	78,084	50	300
D60812045	12 x 45	77,813	50	300
D60812050	12 x 50	82,143	50	300
D60812060	12 x 60	94,763	50	200
D60812070	12 x 70	111,077	50	200
D60812080	12 x 80	116,030	50	200
D60812090	12 x 90	130,163	50	200
D60812100	12 x 100	144,270	50	200



Disponible en varios recubrimientos. Consulte precio y plazo de entrega.

Tornillo ranurado, cabeza cilíndrica, 4.8

DIN-84

METAL



CÓDIGO	MEDIDA	€/100		
T0840304Z	M3 x 4	1,917	1.000	45.000
T0840306Z	M3 x 6	1,933	1.000	30.000
T0840308Z	M3 x 8	2,007	1.000	30.000
T0840310Z	M3 x 10	2,063	1.000	24.000
T0840312Z	M3 x 12	2,450	1.000	24.000
T0840316Z	M3 x 16	2,603	1.000	16.000
T0840320Z	M3 x 20	3,043	1.000	12.000
T0840325Z	M3 x 25	3,893	1.000	12.000
T0840330Z	M3 x 30	4,477	500	6.000
T0840335Z	M3 x 35	5,150	500	6.000
T0840340Z	M3 x 40	6,217	500	6.000
T0840406Z	M4 x 6	2,830	500	15.000
T0840408Z	M4 x 8	2,893	500	12.000
T0840410Z	M4 x 10	3,027	500	12.000
T0840412Z	M4 x 12	3,177	500	12.000
T0840416Z	M4 x 16	3,597	500	8.000
T0840420Z	M4 x 20	4,080	500	8.000
T0840425Z	M4 x 25	4,277	500	6.000
T0840435Z	M4 x 35	6,563	250	3.000
T0840445Z	M4 x 45	9,067	250	3.000
T0840450Z	M4 x 50	10,743	250	3.000
T0840460Z	M4 x 60	14,753	250	3.000
T0840470Z	M4 x 70	15,577	100	1.200
T0840506Z	M5 x 6	4,087	500	8.000

CÓDIGO	MEDIDA	€/100		
T0840508Z	M5 x 8	4,130	500	12.000
T0840510Z	M5 x 10	4,267	500	8.000
T0840512Z	M5 x 12	4,980	250	7.500
T0840516Z	M5 x 16	5,620	250	6.000
T0840520Z	M5 x 20	5,677	250	6.000
T0840525Z	M5 x 25	6,357	250	4.000
T0840530Z	M5 x 30	7,813	250	4.000
T0840535Z	M5 x 35	9,067	250	3.000
T0840540Z	M5 x 40	9,260	250	3.000
T0840545Z	M5 x 45	11,003	250	3.000
T0840550Z	M5 x 50	12,717	250	3.000
T0840560Z	M5 x 60	15,060	250	1.500
T0840608Z	M6 x 8	6,147	250	1.500
T0840610Z	M6 x 10	6,303	250	4.000
T0840616Z	M6 x 16	8,000	250	4.000
T0840620Z	M6 x 20	9,157	250	3.000
T0840625Z	M6 x 25	9,533	250	3.000
T0840630Z	M6 x 30	11,667	250	3.000
T0840635Z	M6 x 35	12,257	250	1.500
T0840640Z	M6 x 40	12,367	250	1.500
T0840645Z	M6 x 45	14,093	250	1.500
T0840650Z	M6 x 50	15,050	250	1.500
T0840660Z	M6 x 60	17,093	250	1.500



Disponible en varios recubrimientos. Consulte precio y plazo de entrega.

DIN-7985

Tornillo rosca métrica con cabeza alomada PH, 4.8

METAL



Disponible en varios recubrimientos. Consulte precio y plazo de entrega.

CÓDIGO	MEDIDA	€/100	PH	1.000	30.000	CÓDIGO	MEDIDA	€/100	PH	500	8.000
T9850306Z	M3 x 6	1,813	PH1	1.000	30.000	T9850510Z	M5 x 10	5,106	PH2	500	8.000
T9850308Z	M3 x 8	1,837	PH1	1.000	30.000	T9850512Z	M5 x 12	5,463	PH2	250	6.000
T9850310Z	M3 x 10	1,857	PH1	1.000	24.000	T9850516Z	M5 x 16	5,982	PH2	250	4.000
T9850312Z	M3 x 12	2,043	PH1	1.000	24.000	T9850520Z	M5 x 20	6,555	PH2	250	4.000
T9850316Z	M3 x 16	2,193	PH1	1.000	16.000	T9850525Z	M5 x 25	7,152	PH2	250	4.000
T9850320Z	M3 x 20	2,667	PH1	1.000	12.000	T9850530Z	M5 x 30	8,330	PH2	250	2.000
T9850325Z	M3 x 25	3,091	PH1	500	12.000	T9850535Z	M5 x 35	9,618	PH2	250	3.000
T9850330Z	M3 x 30	3,543	PH1	500	12.000	T9850540Z	M5 x 40	10,722	PH2	250	3.000
T9850406Z	M4 x 6	2,847	PH2	500	12.000	T9850545Z	M5 x 45	11,019	PH2	250	2.000
T9850408Z	M4 x 8	2,883	PH2	500	12.000	T9850550Z	M5 x 50	13,155	PH2	250	2.000
T9850410Z	M4 x 10	3,192	PH2	500	12.000	T9850608Z	M6 x 8	7,548	PH3	250	6.000
T9850412Z	M4 x 12	3,276	PH2	500	8.000	T9850610Z	M6 x 10	7,830	PH3	250	4.000
T9850416Z	M4 x 16	3,705	PH2	500	8.000	T9850612Z	M6 x 12	7,656	PH3	250	4.000
T9850420Z	M4 x 20	3,980	PH2	500	8.000	T9850616Z	M6 x 16	8,490	PH3	250	4.000
T9850425Z	M4 x 25	4,913	PH2	500	6.000	T9850620Z	M6 x 20	9,690	PH3	250	3.000
T9850430Z	M4 x 30	5,433	PH2	500	6.000	T9850625Z	M6 x 25	10,722	PH3	250	3.000
T9850435Z	M4 x 35	6,807	PH2	250	3.000	T9850630Z	M6 x 30	11,943	PH3	250	3.000
T9850440Z	M4 x 40	7,119	PH2	250	3.000	T9850635Z	M6 x 35	13,476	PH3	250	3.000
T9850450Z	M4 x 50	9,520	PH2	250	3.000	T9850640Z	M6 x 40	15,012	PH3	250	1.500
T9850506Z	M5 x 6	4,910	PH2	500	8.000	T9850650Z	M6 x 50	18,378	PH3	250	1.500
T9850508Z	M5 x 8	4,524	PH2	500	8.000	T9850660Z	M6 x 60	19,815	PH3	250	1.500

Blíster

CÓDIGO	MEDIDA	€/BOLSA	PCS BOLSA	BOLSAS
BZT9850306Z	M3 x 6	1,943	10	20
BZT9850310Z	M3 x 10	1,943	10	20
BZT9850316Z	M3 x 16	1,943	6	20
BZT9850320Z	M3 x 20	1,943	6	20
BZT9850330Z	M3 x 30	1,943	6	20
BZT9850416Z	M4 x 16	1,943	6	20
BZT9850420Z	M4 x 20	1,943	6	20
BZT9850430Z	M4 x 30	1,943	6	20
BZT9850510Z	M5 x 10	1,943	6	20
BZT9850520Z	M5 x 20	1,943	6	20
BZT9850525Z	M5 x 25	1,943	6	20
BZT9850530Z	M5 x 30	1,943	6	20
BZT9850540Z	M5 x 40	1,943	6	20
BZT9850610Z	M6 x 10	1,943	6	20
BZT9850616Z	M6 x 16	1,943	6	20
BZT9850620Z	M6 x 20	1,943	6	20
BZT9850625Z	M6 x 25	1,943	6	20
BZT9850630Z	M6 x 30	1,943	6	20
BZT9850640Z	M6 x 40	1,943	6	15
BZT9850650Z	M6 x 50	1,943	4	15
BZT9850660Z	M6 x 60	1,943	4	15

Caja ventana

CÓDIGO	MEDIDA	€/CAJA	PCS CAJA	CAJAS
VT9850306Z	M3 x 6	4,139	150	8
VT9850310Z	M3 x 10	4,261	150	8
VT9850316Z	M3 x 16	4,013	100	8
VT9850320Z	M3 x 20	4,016	100	8
VT9850330Z	M3 x 30	4,617	100	8
VT9850406Z	M4 x 6	4,038	100	8
VT9850408Z	M4 x 8	4,377	100	8
VT9850410Z	M4 x 10	4,472	100	8
VT9850416Z	M4 x 16	5,008	100	8
VT9850420Z	M4 x 20	5,148	100	8
VT9850506Z	M5 x 6	5,547	100	8
VT9850510Z	M5 x 10	5,904	100	8
VT9850512Z	M5 x 12	5,371	70	8
VT9850516Z	M5 x 16	5,497	70	8
VT9850520Z	M5 x 20	5,891	70	8
VT9850530Z	M5 x 30	5,293	50	8
VT9850540Z	M5 x 40	6,709	50	8
VT9850550Z	M5 x 50	8,772	50	8
VT9850610Z	M6 x 10	6,832	70	8
VT9850612Z	M6 x 12	7,288	70	8
VT9850616Z	M6 x 16	7,692	70	8
VT9850620Z	M6 x 20	7,501	50	8
VT9850630Z	M6 x 30	7,369	50	8
VT9850640Z	M6 x 40	9,257	50	8
VT9850650Z	M6 x 50	11,404	50	8
VT9850660Z	M6 x 60	12,219	50	8



Tornillo rosca métrica con cabeza avellanada ranurada, 4.8

DIN-963

METAL



CÓDIGO	MEDIDA	€/100		
T9630410Z	M4 x 10	2,860	500	22.500
T9630412Z	M4 x 12	3,020	500	22.500
T9630416Z	M4 x 16	3,097	500	12.000
T9630420Z	M4 x 20	3,730	500	12.000
T9630430Z	M4 x 30	4,657	500	6.000
T9630440Z	M4 x 40	5,877	250	3.000
T9630450Z	M4 x 50	8,307	250	3.000
T9630510Z	M5 x 10	3,270	500	12.000
T9630512Z	M5 x 12	3,880	500	12.000
T9630516Z	M5 x 16	4,027	250	7.500
T9630520Z	M5 x 20	5,413	250	6.000
T9630525Z	M5 x 25	5,830	250	6.000
T9630530Z	M5 x 30	6,017	250	4.000

CÓDIGO	MEDIDA	€/100		
T9630540Z	M5 x 40	9,290	250	3.000
T9630550Z	M5 x 50	11,237	250	3.000
T9630560Z	M5 x 60	13,557	250	1.500
T9630610Z	M6 x 10	5,287	250	11.250
T9630612Z	M6 x 12	5,510	250	11.250
T9630616Z	M6 x 16	5,830	250	6.000
T9630620Z	M6 x 20	7,867	250	4.000
T9630625Z	M6 x 25	8,043	250	3.000
T9630630Z	M6 x 30	8,720	250	3.000
T9630640Z	M6 x 40	11,803	250	1.500
T9630650Z	M6 x 50	13,397	250	1.500
T9630660Z	M6 x 60	15,590	250	1.500



Disponible en varios recubrimientos. Consulte precio y plazo de entrega.

Tornillo rosca métrica con cabeza avellanada PH, 4.8

DIN-965

METAL



CÓDIGO	MEDIDA	€/100			
T9650306Z	M3 x 6	1,790	PH1	1.000	45.000
T9650308Z	M3 x 8	1,617	PH1	1.000	45.000
T9650310Z	M3 x 10	1,840	PH1	1.000	30.000
T9650312Z	M3 x 12	1,870	PH1	1.000	24.000
T9650316Z	M3 x 16	2,153	PH1	500	22.500
T9650320Z	M3 x 20	2,480	PH1	500	22.500
T9650325Z	M3 x 25	3,007	PH1	500	12.000
T9650408Z	M4 x 8	2,690	PH2	500	22.500
T9650410Z	M4 x 10	2,860	PH2	500	12.000
T9650412Z	M4 x 12	2,927	PH2	500	22.500
T9650416Z	M4 x 16	3,197	PH2	500	12.000
T9650420Z	M4 x 20	3,853	PH2	500	12.000
T9650425Z	M4 x 25	4,323	PH2	500	6.000
T9650430Z	M4 x 30	4,920	PH2	500	6.000
T9650435Z	M4 x 35	5,447	PH2	500	6.000
T9650440Z	M4 x 40	6,573	PH2	250	3.000
T9650450Z	M4 x 50	8,457	PH2	250	3.000
T9650510Z	M5 x 10	4,207	PH2	250	11.250
T9650512Z	M5 x 12	4,527	PH2	250	11.250

CÓDIGO	MEDIDA	€/100			
T9650516Z	M5 x 16	5,153	PH2	250	6.000
T9650520Z	M5 x 20	5,553	PH2	250	6.000
T9650525Z	M5 x 25	6,050	PH2	250	6.000
T9650530Z	M5 x 30	7,087	PH2	250	4.000
T9650535Z	M5 x 35	7,423	PH2	250	6.000
T9650540Z	M5 x 40	9,557	PH2	250	3.000
T9650550Z	M5 x 50	10,587	PH2	250	3.000
T9650560Z	M5 x 60	14,850	PH2	250	1.500
T9650610Z	M6 x 10	6,290	PH3	250	6.000
T9650612Z	M6 x 12	6,110	PH3	250	6.000
T9650616Z	M6 x 16	6,567	PH3	250	6.000
T9650620Z	M6 x 20	8,150	PH3	250	4.000
T9650625Z	M6 x 25	8,997	PH3	250	3.000
T9650630Z	M6 x 30	11,110	PH3	250	3.000
T9650635Z	M6 x 35	10,890	PH3	250	3.000
T9650640Z	M6 x 40	13,643	PH3	250	1.500
T9650660Z	M6 x 60	18,703	PH3	100	1.200
T9650650Z	M6 x 50	15,780	PH3	250	1.500



Disponible en varios recubrimientos. Consulte precio y plazo de entrega.

Blíster

CÓDIGO	MEDIDA	€/BOLSA	PCS	BOLSAS
BZT9650410Z	M4 x 10	1,943	6	20
BZT9650420Z	M4 x 20	1,943	6	20
BZT9650430Z	M4 x 30	1,943	6	20
BZT9650510Z	M5 x 10	1,943	6	20
BZT9650520Z	M5 x 20	1,943	6	20
BZT9650525Z	M5 x 25	1,943	6	20
BZT9650530Z	M5 x 30	1,943	6	20
BZT9650620Z	M6 x 20	1,943	6	20
BZT9650630Z	M6 x 30	1,943	6	20
BZT9650640Z	M6 x 40	1,943	6	20

Caja ventana

CÓDIGO	MEDIDA	€/CAJA	PCS	CAJAS
VT9650306Z	M3 x 6	4,743	200	8
VT9650310Z	M3 x 10	4,608	200	8
VT9650408Z	M4 x 8	3,783	100	8
VT9650410Z	M4 x 10	3,828	100	8
VT9650416Z	M4 x 16	4,081	100	8
VT9650420Z	M4 x 20	4,816	100	8
VT9650425Z	M4 x 25	5,413	100	8
VT9650430Z	M4 x 30	6,169	100	8
VT9650510Z	M5 x 10	3,983	70	8
VT9650516Z	M5 x 16	4,728	70	8
VT9650520Z	M5 x 20	4,997	70	8
VT9650530Z	M5 x 30	4,350	50	8
VT9650540Z	M5 x 40	5,973	50	8
VT9650610Z	M6 x 10	5,721	70	8
VT9650616Z	M6 x 16	6,214	70	8
VT9650620Z	M6 x 20	7,114	70	8
VT9650630Z	M6 x 30	6,607	50	8

DIN-934

Tuerca hexagonal

DIN-934

METAL



Cincada



Disponible en varios recubrimientos. Consulte precio y plazo de entrega.

CÓDIGO	MEDIDA	€/100	LLAVE DE INSTALACIÓN		
D93403	M3	1,297	5,5	500	22.500
D93404	M4	1,340	7	1.000	45.000
D93405	M5	1,740	8	500	12.000
D93406	M6	2,727	10	500	12.000
D93408	M8	4,877	13	250	6.000
D93410	M10	11,630	17	250	3.000
D93412	M12	17,417	19	250	1.500
D93414	M14	24,527	22	100	1.200
D93416	M16	36,483	24	100	600
D93418	M18	52,080	27	100	600
D93420	M20	60,683	30	50	600
D93422	M22	97,337	32	50	300
D93424	M24	136,547	36	25	300
D93427	M27	218,610	41	25	150
D93430	M30	290,297	46	25	150
D93433	M33	413,743	50	10	120
D93436	M36	473,517	55	10	60

Blíster

CÓDIGO	MEDIDA	€/BOLSA	PCS	BOLSAS
BZ934ZM03	M3	1,943	40	20
BZ934ZM04	M4	1,943	40	20
BZ934ZM05	M5	1,943	40	20
BZ934ZM06	M6	1,943	20	20
BZ934ZM08	M8	1,943	10	20
BZ934ZM10	M10	1,943	10	15
BZ934ZM12	M12	1,943	6	15

Caja ventana

CÓDIGO	MEDIDA	€/CAJA	PCS	CAJAS
VD93403	M3	3,161	150	8
VD93404	M4	3,161	150	8
VD93405	M5	2,749	100	8
VD93406	M6	3,935	100	8
VD93408	M8	3,622	50	8
VD93410	M10	5,046	30	8
VD93412	M12	5,314	20	8

DIN-934 A2

INOXIDABLE



Inoxidable A2



CÓDIGO	MEDIDA	€/100	LLAVE DE INSTALACIÓN		
D934IM04	M4	3,590	7	500	22.500
D934IM05	M5	4,151	8	500	12.000
D934IM06	M6	6,851	10	500	12.000
D934IM08	M8	13,895	13	250	4.000
D934IM10	M10	30,997	17	250	2.000
D934IM12	M12	45,447	19	250	1.500
D934IM14	M14	69,167	22	100	800
D934IM16	M16	97,060	24	100	600
D934IM18	M18	154,370	27	100	600
D934IM20	M20	202,697	30	50	400
D934IM22	M22	280,170	32	50	300
D934IM24	M24	364,217	36	25	200

Blíster

CÓDIGO	MEDIDA	€/BOLSA	PCS	BOLSAS
BZ934IM04	M4	2,459	10	20
BZ934IM05	M5	2,459	8	20
BZ934IM06	M6	2,459	8	20
BZ934IM08	M8	2,459	6	20
BZ934IM10	M10	2,459	5	15

Caja ventana

CÓDIGO	MEDIDA	€/CAJA	PCS	CAJAS
VD934IM04	M4	2,799	50	8
VD934IM05	M5	3,237	50	8
VD934IM06	M6	4,806	50	8
VD934IM08	M8	5,850	30	8
VD934IM10	M10	8,700	20	8



Tuerca autoblocante

DIN-985

METAL



DIN-985

Cincada

CÓDIGO	MEDIDA	€/100	LLAVE DE INSTALACIÓN		
DZ98503	M3	2,403	5,5	500	22.500
DZ98504	M4	2,374	7	500	12.000
DZ98505	M5	2,542	8	500	12.000
DZ98506	M6	3,542	10	500	12.000
DZ98508	M8	6,327	13	250	6.000
DZ98510	M10	14,008	17	250	2.000
DZ98512	M12	22,052	19	100	1.200
DZ98514	M14	37,303	22	100	1.200
DZ98516	M16	45,463	24	50	600
DZ98518	M18	75,223	27	50	600
DZ98520	M20	94,577	30	25	300
DZ98522	M22	153,563	32	25	300
DZ98524	M24	186,643	36	25	300
DZ98527	M27	369,520	41	15	180
DZ98530	M30	625,197	46	15	90



Disponible en varios recubrimientos. Consulte precio y plazo de entrega.

Blíster

CÓDIGO	MEDIDA	€/BOLSA	PCS	BOLSAS
BZZ98503	M3	1,943	20	20
BZZ98504	M4	1,943	20	20
BZZ98505	M5	1,943	20	20
BZZ98506	M6	1,943	10	20
BZZ98508	M8	1,943	5	20
BZZ98510	M10	1,943	5	15
BZZ98512	M12	1,943	3	15

Caja ventana

CÓDIGO	MEDIDA	€/CAJA	PCS	CAJAS
VDZ98503	M3	3,835	100	8
VDZ98504	M4	3,835	100	8
VDZ98505	M5	4,001	100	8
VDZ98506	M6	4,617	80	8
VDZ98508	M8	4,581	50	8
VDZ98510	M10	5,111	25	8
VDZ98512	M12	5,120	15	8

INOXIDABLE



DIN-985 A2

Inoxidable A2

CÓDIGO	MEDIDA	€/100	LLAVE DE INSTALACIÓN		
D985IM04	M4	6,440	7	500	22.500
D985IM05	M5	6,933	8	500	8.000
D985IM06	M6	9,798	10	500	8.000
D985IM08	M8	20,448	13	250	4.000
D985IM10	M10	41,129	17	250	2.000
D985IM12	M12	63,931	19	100	1.200
D985IM14	M14	121,010	22	100	800
D985IM16	M16	146,667	24	50	600
D985IM18	M18	335,650	27	50	400
D985IM20	M20	430,477	30	25	300
D985IM22	M22	974,347	32	25	300
D985IM24	M24	1.313,707	36	25	150



Blíster

CÓDIGO	MEDIDA	€/BOLSA	PCS	BOLSAS
BZ985IM04	M4	2,459	10	20
BZ985IM05	M5	2,459	8	20
BZ985IM06	M6	2,459	8	20
BZ985IM08	M8	2,459	6	20
BZ985IM10	M10	2,459	5	15

Caja ventana

CÓDIGO	MEDIDA	€/CAJA	PCS	CAJAS
VD985IM04	M4	4,515	50	8
VD985IM05	M5	4,866	50	8
VD985IM06	M6	6,873	50	8
VD985IM08	M8	8,130	30	8
VD985IM10	M10	11,544	20	8

DIN-6923

Tuerca brida grafilada

DIN-6923

METAL



Cincada



CÓDIGO	MEDIDA	€/100	LLAVE DE INSTALACIÓN		
D692304	M4	2,563	7	500	15.000
D692305	M5	3,163	8	500	12.000
D692306	M6	4,783	10	500	8.000
D692308	M8	9,313	13	250	3.000
D692310	M10	15,197	15	250	2.000
D692312	M12	24,107	18	250	1.000
D692314	M14	42,157	21	100	600
D692316	M16	52,983	24	100	400



Disponible en varios recubrimientos. Consulte precio y plazo de entrega.

DIN-6923 A2

METAL



Tuerca brida grafilada DIN-6923. Inoxidable A2



CÓDIGO	MEDIDA	€/100	LLAVE DE INSTALACIÓN		
D6923IM08	M8	24,660	13	250	3.000
D6923IM10	M10	47,753	15	250	3.000
D6923IM12	M12	70,740	18	250	1.500

DIN-1587

Tuerca ciega

METAL



CÓDIGO	MEDIDA	€/100	LLAVE DE INSTALACIÓN		
D158704	M4	6,593	7	500	15.000
D158705	M5	6,990	8	250	7.500
D158706	M6	8,190	10	250	4.000
D158708	M8	15,977	13	100	2.400
D158710	M10	30,810	17	100	1.600
D158712	M12	46,757	19	50	800
D158714	M14	79,920	22	50	600
D158716	M16	84,677	24	25	300



Disponible en varios recubrimientos. Consulte precio y plazo de entrega.

Blíster

CÓDIGO	MEDIDA	€/BOLSA	PCS BOLSA	BOLSAS
BZ158704	M4	1,943	20	20
BZ158705	M5	1,943	20	20
BZ158706	M6	1,943	10	20
BZ158708	M8	1,943	5	20
BZ158710	M10	1,943	5	20
BZ158712	M12	1,943	3	20

Caja ventana

CÓDIGO	MEDIDA	€/CAJA	PCS CAJA	CAJAS
VD158704	M4	6,342	75	8
VD158705	M5	4,486	50	8
VD158706	M6	5,250	50	8
VD158708	M8	5,123	25	8
VD158710	M10	7,901	20	8
VD158712	M12	5,997	10	8



Arandela plana

DIN-125

METAL



DIN-125

Cincada

CÓDIGO	MEDIDA	€/100		
D12503	M3	0,652	1.000	45.000
D12504	M4	0,823	1.000	45.000
D12505	M5	1,187	1.000	45.000
D12506	M6	1,745	500	22.500
D12508	M8	3,098	250	11.250
D12510	M10	5,564	250	6.000
D12512	M12	9,253	250	3.000
D12514	M14	12,007	200	2.400
D12516	M16	15,478	100	2.400
D12518	M18	19,972	100	2.400
D12520	M20	23,209	50	1.200
D12522	M22	38,792	50	1.200
D12524	M24	53,080	50	600
D12527	M27	72,200	50	600
D12530	M30	96,070	50	300
D12533	M33	148,888	50	300
D12536	M36	200,712	25	300



Disponible en varios recubrimientos. Consulte precio y plazo de entrega.

Blíster

CÓDIGO	MEDIDA	€/BOLSA	PCS B	BOLSAS
BZ125M03	M3	1,943	40	20
BZ125M04	M4	1,943	40	20
BZ125M05	M5	1,943	40	20
BZ125M06	M6	1,943	20	20
BZ125M08	M8	1,943	10	20
BZ125M10	M10	1,943	10	20
BZ125M12	M12	1,943	6	20

Caja ventana

CÓDIGO	MEDIDA	€/CAJA	PCS	CAJAS
VD12503	M3	3,317	200	8
VD12504	M4	3,317	200	8
VD12505	M5	3,029	150	8
VD12506	M6	3,591	100	8
VD12508	M8	4,147	75	8
VD12510	M10	7,679	75	8
VD12512	M12	9,049	50	8

INOXIDABLE



DIN-125 A2

Inoxidable A2

CÓDIGO	MEDIDA	€/100		
D125IM04	M4	1,217	500	22.500
D125IM05	M5	1,610	500	22.500
D125IM06	M6	2,917	500	22.500
D125IM08	M8	5,003	250	11.250
D125IM10	M10	9,557	250	6.000
D125IM12	M12	19,037	250	3.000
D125IM14	M14	26,643	200	2.400
D125IM16	M16	29,420	100	2.400
D125IM18	M18	43,627	100	1.600
D125IM20	M20	46,327	50	1.200
D125IM22	M22	54,937	50	1.200
D125IM24	M24	96,120	50	600



Blíster

CÓDIGO	MEDIDA	€/BOLSA	PCS B	BOLSAS
BZ125IM04	M4	2,459	10	20
BZ125IM05	M5	2,459	8	20
BZ125IM06	M6	2,459	8	20
BZ125IM08	M8	2,459	6	20
BZ125IM10	M10	2,459	5	20

Caja ventana

CÓDIGO	MEDIDA	€/CAJA	PCS	CAJAS
VD125IM04	M4	2,986	100	8
VD125IM05	M5	2,995	75	8
VD125IM06	M6	3,788	75	8
VD125IM08	M8	3,949	50	8
VD125IM10	M10	6,581	50	8

DIN-9021

Arandela plana ancha

DIN-9021

METAL



Cincada



CÓDIGO	MEDIDA	€/100		
D902103	M3	1,450	500	22.500
D902104	M4	1,466	500	12.000
D902106	M6	3,218	500	12.000
D902105	M5	2,108	500	12.000
D902108	M8	7,457	200	4.800
D902110	M10	13,502	100	2.400
D902112	M12	27,541	100	1.200
D902114	M14	38,475	100	800
D902116	M16	46,480	50	600
D902118	M18	85,285	50	600
D902120	M20	92,749	25	300
D902122	M22	179,088	25	300
D902124	M24	203,810	25	150



Disponible en varios recubrimientos. Consulte precio y plazo de entrega.

Blíster

CÓDIGO	MEDIDA	€/BOLSA	PCS	BOLSAS
BZ902103	M3	1,943	20	20
BZ902104	M4	1,943	20	20
BZ902105	M5	1,943	20	20
BZ902106	M6	1,943	10	20
BZ902108	M8	1,943	5	20
BZ902110	M10	1,943	5	20
BZ902112	M12	1,943	4	20

Caja ventana

CÓDIGO	MEDIDA	€/CAJA	PCS	CAJAS
VD902103	M3	3,360	125	8
VD902104	M4	3,360	125	8
VD902105	M5	4,233	125	8
VD902106	M6	4,712	100	8
VD902108	M8	5,142	50	8
VD902110	M10	5,399	30	8
VD902112	M12	5,121	15	8

DIN-9021 A2

INOXIDABLE



Inoxidable A2



CÓDIGO	MEDIDA	€/100		
D9021IM04	M4	2,460	500	22.500
D9021IM05	M5	4,410	500	12.000
D9021IM06	M6	7,990	500	8.000
D9021IM08	M8	16,463	200	4.800
D9021IM10	M10	35,630	100	1.600
D9021IM12	M12	61,450	100	800
D9021IM14	M14	138,600	100	800
D9021IM16	M16	134,200	50	600
D9021IM18	M18	240,293	50	400
D9021IM20	M20	257,160	25	300
D9021IM22	M22	277,533	25	200
D9021IM24	M24	326,099	25	150

Blíster

CÓDIGO	MEDIDA	€/BOLSA	PCS	BOLSAS
BZ9021IM04	M4	2,459	10	20
BZ9021IM05	M5	2,459	8	20
BZ9021IM06	M6	2,459	8	20
BZ9021IM08	M8	2,459	6	20
BZ9021IM10	M10	2,459	5	20

Caja ventana

CÓDIGO	MEDIDA	€/CAJA	PCS	CAJAS
VD9021IM04	M4	3,667	100	8
VD9021IM05	M5	4,525	75	8
VD9021IM06	M6	8,049	75	8
VD9021IM08	M8	8,623	40	8
VD9021IM10	M10	9,754	20	8



Arandela muelle Grower

DIN-127

METAL



CÓDIGO	MEDIDA	€/100		
D12703	M3	0,579	500	22.500
D12704	M4	0,749	500	22.500
D12705	M5	0,963	500	22.500
D12706	M6	1,352	500	12.000
D12708	M8	2,873	200	4.800
D12710	M10	4,535	100	2.400
D12712	M12	6,682	100	2.400
D12714	M14	9,779	100	2.400
D12716	M16	15,779	50	1.200
D12718	M18	17,196	50	1.200
D12720	M20	24,528	25	300
D12722	M22	27,585	25	600
D12724	M24	49,278	25	600
D12727	M27	72,792	25	600
D12730	M30	134,755	25	300
D12736	M36	273,408	25	300

DIN-127

Arandela muelle Grower



Disponible en varios recubrimientos. Consulte precio y plazo de entrega.

Blíster

CÓDIGO	MEDIDA	€/BOLSA	PCS B	BOLSAS
BZ12703	M3	1,943	20	20
BZ12704	M4	1,943	20	20
BZ12705	M5	1,943	20	20
BZ12706	M6	1,943	10	20
BZ12708	M8	1,943	5	20
BZ12710	M10	1,943	5	20
BZ12712	M12	1,943	4	20

Caja ventana

CÓDIGO	MEDIDA	€/CAJA	PCS	CAJAS
VD12704	M4	2,670	100	8
VD12705	M5	2,946	100	8
VD12706	M6	3,692	100	8
VD12708	M8	3,572	50	8
VD12710	M10	3,259	25	8
VD12712	M12	4,236	25	8

METAL



CÓDIGO	MEDIDA	€/100		
D127IM08	M8	4,530	200	9.000
D127IM10	M10	7,237	100	4.500
D127IM12	M12	10,923	100	4.500

DIN-127 A2

Arandela muelle grower DIN-127. Inoxidable A2



TU-MA

Tuerca mariposa

METAL



Disponible en varios recubrimientos. Consulte precio y plazo de entrega.

CÓDIGO	MEDIDA	€/100		
TUMAM03	M3	13,363	500	12.000
TUMAM04	M4	13,690	500	8.000
TUMAM05	M5	13,950	250	6.000
TUMAM06	M6	15,667	250	6.000
TUMAM08	M8	21,780	100	2.400
TUMAM10	M10	35,550	100	1.600
TUMAM12	M12	67,317	50	1.200
TUMAM14	M14	219,333	50	-
TUMAM16	M16	226,280	25	300

Blíster

CÓDIGO	MEDIDA	€/BOLSA	PCS	BOLSAS
BZTUMAM03	M3	2,459	10	20
BZTUMAM04	M4	2,459	10	20
BZTUMAM05	M5	2,459	10	20
BZTUMAM06	M6	2,459	10	20
BZTUMAM08	M8	2,459	5	20
BZTUMAM10	M10	2,459	5	20
BZTUMAM12	M12	2,459	3	20

Caja ventana

CÓDIGO	MEDIDA	€/CAJA	PCS	CAJAS
VTUMAM03	M3	12,953	75	8
VTUMAM04	M4	13,272	75	8
VTUMAM05	M5	9,382	50	8
VTUMAM06	M6	10,127	50	8
VTUMAM08	M8	7,043	25	8
VTUMAM10	M10	9,560	20	8
VTUMAM12	M12	9,050	10	8

DIN-6798 A

Arandela dentada exterior

METAL



Disponible en varios recubrimientos. Consulte precio y plazo de entrega.

CÓDIGO	MEDIDA	€/100		
D6798A03	M3	1,154	500	22.500
D6798A04	M4	1,193	500	22.500
D6798A05	M5	1,427	500	22.500
D6798A06	M6	1,991	500	22.500
D6798A08	M8	3,612	250	11.250
D6798A10	M10	6,558	250	11.250
D6798A12	M12	8,297	100	4.500
D6798A14	M14	12,788	100	4.500
D6798A16	M16	16,011	100	4.500



BROCAS, PUNTAS Y ACCESORIOS





B-HDS

Broca SDS-Plus de alta calidad

MACIZOS



CÓDIGO	MEDIDA	€/PC	UD. MIN. VENTA		
BHDS06110	Ø6 x 110	21,230	2	1	50
BHDS06160	Ø6 x 160	21,727	2	1	100
BHDS06210	Ø6 x 210	23,287	2	1	150
BHDS08110	Ø8 x 110	21,727	2	1	50
BHDS08160	Ø8 x 160	22,707	2	1	100
BHDS08210	Ø8 x 210	23,777	2	1	150
BHDS10160	Ø10 x 160	24,300	2	1	100
BHDS10210	Ø10 x 210	27,617	2	1	150
BHDS12160	Ø12 x 160	27,163	2	1	100
BHDS12210	Ø12 x 210	29,740	2	1	150
BHDS16210	Ø16 x 210	45,937	2	1	150
BHDS16310	Ø16 x 260	67,810	2	1	200

PUN



Puntas de atornillar

PU-PH

METAL

PH



CÓDIGO	MEDIDA	€/100	LONGITUD			
PUPHC01	PH1	73,543	25	PH1	25	1.125
PUPHC02	PH2	73,543	25	PH2	25	1.125
PUPHC03	PH3	73,543	25	PH3	25	1.125
PUPHL01	PH1	117,973	50	PH1	25	1.125
PUPHL02	PH2	117,973	50	PH2	25	1.125
PUPHL03	PH3	117,973	50	PH3	25	1.125

 Blíster



CÓDIGO	MEDIDA	€/BOLSA	PCS	BOLSAS
BZPUPHCL01	PH1	3,216	4	20
BZPUPHCL02	PH2	3,216	4	20
BZPUPHCL03	PH3	3,216	4	20

PU-TO

METAL

TX



CÓDIGO	MEDIDA	€/100	LONGITUD			
PUT0010	T10	82,853	25	TX10	25	1.125
PUT0015	T15	82,853	25	TX15	25	1.125
PUT0020	T20	82,853	25	TX20	25	1.125
PUT0025	T25	82,853	25	TX25	25	1.125
PUT0030	T30	82,853	25	TX30	25	1.125
PUT0040	T40	82,853	25	TX40	25	1.125



 Blíster

CÓDIGO	MEDIDA	€/BOLSA	PCS	BOLSAS
BZPUTOT01	T10+T20	3,216	2	20
BZPUTOT02	T30+T40	3,216	2	20

METAL

PU-OX

OXBIT

CÓDIGO	MEDIDA	€/100	LONGITUD			
PUOXBITC10	OXB-10	103,570	25	OXB-10	25	1.125
PUOXBITC15	OXB-15	103,570	25	OXB-15	25	1.125
PUOXBITC20	OXB-20	103,570	25	OXB-20	25	1.125
PUOXBITC25	OXB-25	103,570	25	OXB-25	25	1.125
PUOXBITC30	OXB-30	103,570	25	OXB-30	25	1.125
PUOXBITC40	OXB-40	103,570	25	OXB-40	25	1.125
PUOXBITL10	OXB-10	177,367	50	OXB-10	25	1.125
PUOXBITL15	OXB-15	177,367	50	OXB-15	25	1.125
PUOXBITL20	OXB-20	177,367	50	OXB-20	25	1.125
PUOXBITL25	OXB-25	177,367	50	OXB-25	25	1.125
PUOXBITL30	OXB-30	177,367	50	OXB-30	25	1.125
PUOXBITL40	OXB-40	177,367	50	OXB-40	25	1.125



CARACTERÍSTICAS

Ajuste perfecto en tornillo:

Garantizan que el tornillo quede totalmente fijado en la punta, permitiendo una instalación ergonómica en cualquier posición y mejorando el guiado del tornillo.

Transmisión óptima de la fuerza:

Aseguran un asiento perfecto en la mortaja y aumentan la superficie de apriete, optimizando la transmisión del par de apriete.

Anti Cam-Out:

Las puntas OXBIT reducen el efecto "Cam-Out" que en el caso de trabajos con máquina son especialmente altas y pueden provocar un deslizamiento de la punta saliéndose de la mortaja del tornillo. Esto aumenta la vida útil de las puntas y de las mortajas.

Ideal para aplicaciones de altas prestaciones:

Especialmente diseñadas para garantizar la transmisión en trabajos con pares altos, soportan altas velocidades y el par de los atornilladores de impacto.

Menor esfuerzo:

Aumentan la transmisión del par de apriete, permitiendo la instalación con un menor esfuerzo, incluso con pares de apriete elevados.

Aumento de la vida útil de la punta:



Gracias al diseño de las puntas OXBIT y al ajuste perfecto con la mortaja, permiten alargar la vida útil de las puntas y de las mortajas.



METAL

PU-PO

PZ

CÓDIGO	MEDIDA	€/100	LONGITUD			
PUPOC01	PZ1	73,543	25	PZ1	25	1.125
PUPOC02	PZ2	73,543	25	PZ2	25	1.125
PUPOC03	PZ3	73,543	25	PZ3	25	1.125
PUPOL01	PZ1	117,973	50	PZ1	25	1.125
PUPOL02	PZ2	117,973	50	PZ2	25	1.125
PUPOL03	PZ3	117,973	50	PZ3	25	1.125





Blíster

CÓDIGO	MEDIDA	€/BOLSA	PCS 	BOLSAS 
BZPUPOCL01	PZ1	3,216	4	20
BZPUPOCL02	PZ2	3,216	4	20
BZPUPOCL03	PZ3	3,216	4	20

METAL

PU-CU

Cuadrada

CÓDIGO	MEDIDA	€/100	LONGITUD			
PUCUC01	PC1	73,543	25	PC1	25	1.125
PUCUC02	PC2	73,543	25	PC2	25	1.125
PUCUC03	PC3	73,543	25	PC3	25	1.125
PUCUL01	PC1	117,973	50	PC1	25	1.125
PUCUL02	PC2	117,973	50	PC2	25	1.125
PUCUL03	PC3	117,973	50	PC3	25	1.125





BOCA

Bocas hexagonales magnéticas

METAL



CÓDIGO	MEDIDA	€/100	LONGITUD	LLAVE DE INSTALACIÓN		
BOCA006	6 mm.	426,000	65	1/4"	5	225
BOCA007	7 mm.	426,000	65	1/4"	5	225
BOCA008	8 mm.	426,000	65	1/4"	5	225
BOCA010	10 mm.	426,000	65	1/4"	5	225
BOCA013	NEW 13 mm.	583,333	65	1/4"	5	225
BOCA055	NEW 5,5 mm.	426,000	65	1/4"	5	225

Blíster



CÓDIGO	MEDIDA	€/BOLSA	PCS BLÍSTER	BOLSAS
BZBOCA008	8 mm.	4,463	1	20
BZBOCA010	10 mm.	4,463	1	20

PU-PM

Porta puntas magnético 1/4

METAL





CÓDIGO	MEDIDA	€/100	LONGITUD		
PUPM014	1/4" x 60	540,410	65	5	225

ATAP

Tapón de nylon de colores para tornillos con cabeza hexagonal

METAL





CÓDIGO	COLOR	€/100			
ATAPO08AR	RAL 1001	7,557	8	1.000	2.000
ATAPO08RC	RAL 3003	7,557	8	1.000	2.000
ATAPO08RT	RAL 3011	7,557	8	1.000	2.000
ATAPO08VN	RAL 6028	7,557	8	1.000	2.000
ATAPO08BP	RAL 9010	7,557	8	1.000	2.000
ATAPO08NE	RAL 9005	7,557	8	1.000	2.000
ATAPO08BO	RAL 9002	7,557	8	1.000	2.000
ATAPO10AR	RAL 1001	7,557	10	1.000	2.000
ATAPO10RC	RAL 3003	7,557	10	1.000	2.000
ATAPO10RT	RAL 3011	7,557	10	1.000	2.000
ATAPO10VN	RAL 6028	7,557	10	1.000	2.000
ATAPO10BP	RAL 9010	7,557	10	1.000	2.000
ATAPO10NE	RAL 9005	7,557	10	1.000	2.000
ATAPO10BO	RAL 9002	7,557	10	1.000	2.000
ATAPO08BS	NEW RAL 9003	7,557	8	1.000	2.000
ATAPO08GM	NEW RAL 9006	7,557	8	1.000	2.000
ATAPO08RX	NEW RAL 3009	7,557	8	1.000	2.000
ATAPO08PC	NEW RAL 8004	7,557	8	1.000	2.000
ATAPO10BS	NEW RAL 9003	7,557	10	1.000	2.000
ATAPO10GM	NEW RAL 9006	7,557	10	1.000	2.000
ATAPO10RX	NEW RAL 3009	7,557	10	1.000	2.000
ATAPO10PC	NEW RAL 8004	7,557	10	1.000	2.000

Tapones de PVC para tornillos DIN-7504-N y DIN-7981

TP-CR

METAL



CÓDIGO	MEDIDA	€/100		
TPCR042BL	Ø4,2	3,757	1.000	12.000
TPCR048BL	Ø4,8	3,757	1.000	12.000
TPCR055BL	Ø5,5	3,757	1.000	6.000



TP-CR B

Blanco



METAL



CÓDIGO	MEDIDA	€/100		
TPCR042NE	Ø4,2	3,757	1.000	12.000
TPCR048NE	Ø4,8	3,757	1.000	12.000
TPCR055NE	Ø5,5	3,757	1.000	6.000

TP-CR N

Negro





Tapones adhesivos de colores tapa-tornillo

TP-TP



MADERA



CÓDIGO	DIÁMETRO	COLOR	€/100		
TPTPADBE	14	BEIGE	3,710	1.000	24.000
TPTPADBL	14	BLANCO	3,710	1.000	24.000
TPTPADCA	14	CAOBA	3,710	1.000	24.000
TPTPADCE	14	CEREZO	3,710	1.000	24.000
TPTPADGR	14	GRIS	3,710	1.000	24.000
TPTPADHA	14	HAYA	3,710	1.000	24.000
TPTPADNE	14	NEGRO	3,710	1.000	24.000
TPTPADNO	14	NOGAL	3,710	1.000	24.000
TPTPADPI	14	PINO	3,710	1.000	24.000
TPTPADRO	14	ROBLE	3,710	1.000	24.000
TPTPADSA	14	SAPELLY	3,710	1.000	24.000























 Blíster





















CÓDIGO	COLOR	€/BOLSA	PCS 	BOLSAS 
BZTPTPADBE	BEIGE	1,943	20	25
BZTPTPADBL	BLANCO/WHITE/BLANC	1,943	20	25
BZTPTPADCA	CAOBA/MAHOGANY/ACAJOU	1,943	20	25
BZTPTPADCE	CEREZO/CHERRY/CERISIER	1,943	20	25
BZTPTPADGR	GRIS/GREY/GRIS	1,943	20	25
BZTPTPADHA	HAYA/BEECH/HETRE	1,943	20	25
BZTPTPADNE	NEGRO/BLACK/NOIR	1,943	20	25
BZTPTPADNO	NOGAL/WALNUT/NOYER	1,943	20	25
BZTPTPADPI	PINO/PINE/PIN	1,943	20	25
BZTPTPADRO	ROBLE/OAK/CHÉNE	1,943	20	25
BZTPTPADSA	SAPELLY	1,943	20	25



ABRAZADERAS METÁLICAS PESADAS



	MEDIDAS (mm)	CARGA RECOMENDADA kg	RECUBRIMIENTO	ESPESOR (mm)	ANCHURA (mm)	APERTURA	MANGUITO	HOMOLOGACIÓN	ISOFÓNICA	CTE	
AB-RA	APLICACIONES: Saneamiento Eléctrico									P. 248	
	Ø 15 - Ø 125	80		1,5	20	Rápida lateral	M8	-	-	-	
AB-IA	APLICACIONES: ACS y AF, Gas, Saneamiento, Calefacción, Climatización, Eléctrico, Ventilación									P. 249	
	Ø 15 - Ø 125	80		1,5	20	Rápida lateral	M8	-	✓	✓	
AB-IR	APLICACIONES: ACS y AF, Gas, Saneamiento, Calefacción, Climatización, Eléctrico, Ventilación									P. 249	
	Ø 15 - Ø 60	60		1,25	19	Rápida vertical	M8	-	✓	✓	
AB-RE AB-RE V	APLICACIONES: Saneamiento, Eléctrico, Ventilación									P. 250	
	Ø 18 - Ø 1250	150 - 200		1,8 - 2,3	19	Tornillo	M8 / M10	-	-	-	
AB-RI AB-RI V	APLICACIONES: ACS y AF, Gas, Saneamiento, Calefacción, Climatización, Eléctrico, Ventilación									P. 252	
	Ø 18 - Ø 1250	150 - 200		1,8 - 2,3	19	Tornillo	M8 / M10	-	✓	✓	
AB-RE A2 AB-RE A4	APLICACIONES: ACS y AF, Gas, Saneamiento, Calefacción, Climatización, Eléctrico, Ventilación									P. 251	
	Ø 18 - Ø 1250	150 - 200	 AB-RE A2	 AB-RE A4	1,8 - 2,3	19	Tornillo	M8 / M10	-	✓	✓
AB-RI A2 AB-RI A4	APLICACIONES: ACS y AF, Gas, Saneamiento, Calefacción, Climatización, Eléctrico, Ventilación									P. 253	
	Ø 18 - Ø 1250	150 - 200	 AB-RI A2	 AB-RI A4	1,8 - 2,3	19	Tornillo	M8 / M10	-	✓	✓
AB-RI DES	APLICACIONES: Saneamiento, Eléctrico									P. 254	
	Ø 16 - Ø 160	150		1,2 - 2,0	20	Rápida lateral	M8 / M10	-	✓	✓	
AB-ICP	APLICACIONES: ACS y AF, Gas, Saneamiento, Calefacción, Climatización, Eléctrico, Ventilación									P. 254	
	Ø 60 - Ø 135	200		2,75 - 4,0	30 - 40	Tornillo	M8 / M10 M10 / M12 M12 / M16	-	✓	✓	

	MEDIDAS (mm)	CARGA RECOMENDADA kg	RECUBRIMIENTO	ESPESOR (mm)	ANCHURA (mm)	APERTURA	MANGUITO	HOMOLOGACIÓN	ISOFÓNICA	CTE
AB-AIS	APLICACIONES: ACS y AF, Gas, Saneamiento, Calefacción, Climatización, Eléctrico, Ventilación									P. 255
	Ø 10 - Ø 219	150 - 200		13 - 40	20 - 40	AB-AIS 13 & 19 Rápida lateral AB-AIS 30 & 40 Tornillo	M8 / M10 M8 / M10 M12 / M16	-	 	
AB-GA	APLICACIONES: Gas									P. 256
	Ø 18 - Ø 160	150 - 200		2	19	Tornillo	M8 ≤ Ø54 M8 / M10 > Ø54	De acuerdo a UNE-EN ISO 4892	-	-
AB-M8	APLICACIONES: Saneamiento, Desagüe									P. 256
	Ø 50 - Ø 315	100		1	28	Tornillo	M8	-	-	-
AB-DE Z AB-DE G	APLICACIONES: Saneamiento, Desagüe									P. 257
	Ø 75 - Ø 315	200	 	2,5	20	Tornillo	M8	-	-	-
			AB-DE Z AB-DE G							
AB-DP Z AB-DP G	APLICACIONES: Saneamiento, Desagüe									P. 257
	Ø 75 - Ø 250	200	 	2,5	20	Tornillo	-	-	-	-
			AB-DP Z AB-DP G							
AB-ZI	APLICACIONES: Gas, Saneamiento									P. 258
	Ø 16 - Ø 230	250 - 350		M6 - M8 - M10	-	-	-	-	-	-
AB-SA	APLICACIONES: Gas, Saneamiento									P. 259
	-	-		5 - 6	-	-	-	-	-	-
AB-GP	APLICACIONES: Saneamiento, Industrial									P. 259
	Ø 25 - Ø 235	-		0,6 - 1,8	18 - 25	Tornillo	-	-	-	-

AB-RA

Abrazadera reforzada M8 abierta

02
P. 412 Info.
Técnica

SANEAMIENTO



CÓDIGO	MEDIDA	ØD(mm)	€/100	MEDIDA EN PULGADAS	CARGA MÁXIMA		
ABRA015	15 (M8)	12-16	81,647	1/4"	80	50	300
ABRA018	18 (M8)	15 - 19	81,987	3/8"	80	50	300
ABRA022	22 (M8)	20 - 25	87,677	1/2"	80	50	200
ABRA028	28 (M8)	26 - 30	91,337	3/4"	80	50	200
ABRA035	35 (M8)	32 - 36	97,197	1"	80	50	150
ABRA042	42 (M8)	38 - 43	102,327	1 1/4"	80	50	150
ABRA048	48 (M8)	47 - 51	112,093	1 1/2"	80	50	100
ABRA054	54 (M8)	53 - 58	120,142	-	80	25	100
ABRA060	60 (M8)	60 - 64	125,786	2"	80	25	75
ABRA075	75 (M8)	75 - 80	141,035	2 1/2"	80	25	50
ABRA090	90 (M8)	87 - 92	150,011	3"	80	25	50
ABRA100	100 (M8)	99 - 105	168,470	3 1/2"	80	25	50
ABRA110	110 (M8)	107 - 112	169,228	-	80	25	50
ABRA115	115 (M8)	113 - 118	194,779	4"	80	25	50
ABRA125	125 (M8)	125 - 130	194,497	4 1/2"	80	25	50

EJEMPLOS DE APLICACIÓN





Abrazadera reforzada isofónica M8 abierta

AB-IA

02 Info
P. 412 Técnica

SANEAMIENTO



CÓDIGO	MEDIDA	ØD(mm)	€/100	MEDIDA EN PULGADAS	CARGA MÁXIMA		
ABIA015	15 (M8)	12-16	90,620	1/4"	80	50	200
ABIA018	18 (M8)	15 - 19	94,021	3/8"	80	50	200
ABIA022	22 (M8)	20 - 25	100,815	1/2"	80	50	150
ABIA028	28 (M8)	26 - 30	106,283	3/4"	80	50	100
ABIA035	35 (M8)	32 - 36	113,623	1"	80	50	100
ABIA042	42 (M8)	38 - 43	126,320	1 1/4"	80	50	-
ABIA048	48 (M8)	47 - 51	141,084	1 1/2"	80	50	-
ABIA054	54 (M8)	53 - 58	150,320	-	80	25	50
ABIA060	60 (M8)	60 - 64	161,317	2"	80	25	50
ABIA075	75 (M8)	75 - 80	182,270	2 1/2"	80	25	50
ABIA090	90 (M8)	87 - 92	200,482	3"	80	25	50
ABIA100	100 (M8)	99 - 105	228,592	3 1/2"	80	25	50
ABIA110	110 (M8)	107 - 112	235,821	-	80	25	-
ABIA115	115 (M8)	113 - 118	267,217	4"	80	25	-
ABIA125	125 (M8)	125 - 130	280,218	4 1/2"	80	25	-



EJEMPLOS DE APLICACIÓN



Abrazadera isofónica M8 instalación rápida

AB-IR

02 Info
P. 412 Técnica

SANEAMIENTO



CÓDIGO	MEDIDA	ØD(mm)	€/100	MEDIDA EN PULGADAS	CARGA MÁXIMA		
ABIR015	15 (M8)	14 - 15	79,686	1/4"	60	50	300
ABIR018	18 (M8)	16 - 19	85,213	3/8"	60	50	300
ABIR022	22 (M8)	21 - 23	89,819	1/2"	60	50	200
ABIR028	28 (M8)	26 - 28	98,150	3/4"	60	50	150
ABIR035	35 (M8)	32 - 35	109,786	1"	60	50	100
ABIR040	40 (M8)	40 - 43	123,856	1 1/4"	60	25	100
ABIR048	48 (M8)	48 - 51	137,158	1 1/2"	60	25	100
ABIR054	54 (M8)	52 - 56	143,051	-	60	25	75
ABIR060	60 (M8)	57 - 60	150,201	2"	60	25	75



EJEMPLOS DE APLICACIÓN



AB-RE

Abrazadera reforzada M8 + M10

AB-RE

Cincada

02 Info. Técnica P. 413

SANEAMIENTO



EJEMPLOS DE APLICACIÓN



CÓDIGO	MEDIDA	ØD(MM)	€/100	MEDIDA EN PULGADAS	CARGA MÁXIMA		
ABRE018	18 (M8+M10)	15 - 19	104,145	3/8"	80	50	300
ABRE022	22 (M8+M10)	20 - 25	107,268	1/2"	80	50	200
ABRE028	28 (M8+M10)	26 - 30	117,884	3/4"	80	50	150
ABRE035	35 (M8+M10)	32 - 36	126,530	1"	80	50	100
ABRE040	40 (M8+M10)	38 - 43	132,825	1 1/4"	80	25	100
ABRE048	48 (M8+M10)	47 - 51	146,417	1 1/2"	80	25	100
ABRE054	54 (M8+M10)	53 - 56	156,187	-	80	25	75
ABRE060	60 (M8+M10)	60 - 64	160,293	2"	80	25	75
ABRE070	70 (M8+M10)	68 - 72	172,740	-	80	25	50
ABRE075	75 (M8+M10)	75 - 80	177,260	2 1/2"	150	25	50
ABRE083	83 (M8+M10)	81 - 86	181,215	-	150	25	-
ABRE090	90 (M8+M10)	87 - 92	193,020	3"	150	25	-
ABRE100	100 (M8+M10)	99 - 105	204,867	3 1/2"	150	25	-
ABRE110	110 (M8+M10)	107 - 112	222,203	-	150	25	-
ABRE115	115 (M8+M10)	113 - 118	250,263	4"	200	25	-
ABRE125	125 (M8+M10)	125 - 130	259,524	4 1/2"	200	25	-
ABRE133	133 (M8+M10)	132 - 137	293,047	-	200	25	-
ABRE140	140 (M8+M10)	138 - 142	321,746	5"	200	25	-
ABRE150	150 (M8+M10)	148 - 152	323,731	-	200	25	-
ABRE160	160 (M8+M10)	159 - 166	343,199	6"	200	25	-
ABRE180	180 (M8+M10)	179 - 184	375,510	-	200	25	-
ABRE200	200 (M8+M10)	199 - 212	408,403	-	200	25	-
ABRE220	220 (M8+M10)	215 - 226	465,540	8"	200	25	-
ABRE250	250 (M8+M10)	245 - 254	515,867	-	200	25	-
ABRE280	280 (M8+M10)	278 - 284	589,353	-	200	25	-
ABRE300	300 (M8+M10)	299 - 304	662,840	-	200	25	-
ABRE315	315 (M8+M10)	314 - 319	745,437	-	200	25	-
ABRE355	355 (M8+M10)	354 - 359	944,633	-	200	25	-

Bolsa autoservicio

CÓDIGO	MEDIDA	€/BOLSA	PCS	BOLSAS
LSABRE022	22 (M8+M10)	4,216	2	5
LSABRE028	28 (M8+M10)	4,315	2	5
LSABRE035	35 (M8+M10)	4,412	2	5
LSABRE040	40 (M8+M10)	4,529	2	5
LSABRE048	48 (M8+M10)	4,441	2	5
LSABRE060	60 (M8+M10)	4,649	2	5
LSABRE075	75 (M8+M10)	4,879	2	5
LSABRE090	90 (M8+M10)	5,988	2	5
LSABRE110	110 (M8+M10)	6,210	2	5
LSABRE125	125 (M8+M10)	7,179	2	4

KIT
AB-RE + ES-DR
+ T4S



AB-RE V

Cincada. Ventilación

SANEAMIENTO



CÓDIGO	MEDIDA	ØD(mm)	€/100	MEDIDA EN PULGADAS	CARGA MÁXIMA	
ABRE400	400 (M8+M10)	399 - 404	1.093,794	-	200	25
ABRE450	450 (M8+M10)	449 - 454	1.333,829	-	200	10
ABRE500	500 (M8+M10)	499 - 504	1.339,477	-	200	10
ABRE560	560 (M8+M10)	555 - 561	1.570,221	-	200	10
ABRE600	600 (M8+M10)	599 - 604	1.671,178	-	200	10
ABRE630	630 (M8+M10)	625 - 631	1.824,477	-	200	10
ABRE710	710 (M8+M10)	705 - 711	2.056,817	-	200	10
ABRE800	800 (M8+M10)	799 - 804	2.275,583	-	200	10
ABRE900	900 (M8+M10)	899 - 904	2.522,683	-	200	10
ABRE910	1000 (M8+M10)	999 - 1.004	2.826,213	-	200	10
ABRE911	1120 (M8+M10)	1.115 - 1.121	3.094,363	-	200	10
ABRE912	1250 (M8+M10)	1.245 - 1.251	3.398,440	-	200	10

Abrazadera reforzada M8 + M10

AB-RE

 Info Técnica
P. 614

INOXIDABLE



AB-RE A2

Inoxidable A2

CÓDIGO	MEDIDA	ØD(mm)	€/100	MEDIDA EN PULGADAS	CARGA MÁXIMA		
ABREA2018	18 (M8+M10)	15 - 18	373,661	3/8"	150	50	300
ABREA2022	22 (M8+M10)	20 - 24	392,964	1/2"	150	50	200
ABREA2028	28 (M8+M10)	26 - 30	432,357	3/4"	150	50	150
ABREA2035	35 (M8+M10)	32 - 36	452,397	1"	150	50	100
ABREA2040	40 (M8+M10)	36 - 42	477,819	1 1/4"	150	25	100
ABREA2048	48 (M8+M10)	47 - 50	514,040	1 1/2"	150	25	100
ABREA2054	54 (M8+M10)	51 - 55	542,877	-	150	25	75
ABREA2060	60 (M8+M10)	60 - 64	560,049	2"	150	25	75
ABREA2075	75 (M8+M10)	75 - 80	623,047	2 1/2"	150	25	50
ABREA2090	90 (M8+M10)	87 - 92	716,872	3"	150	25	-
ABREA2110	110 (M8+M10)	106 - 112	775,557	-	150	25	-
ABREA2115	115 (M8+M10)	114 - 119	808,986	4"	150	25	-
ABREA2125	125 (M8+M10)	124 - 131	867,714	4 1/2"	150	25	-
ABREA2140	140 (M8+M10)	133 - 140	988,740	5"	150	25	-
ABREA2160	160 (M8+M10)	159 - 163	1.105,855	6"	150	25	-
ABREA2200	200 (M8+M10)	199 - 212	1.542,543	-	150	25	-



 Info Técnica
P. 614

INOXIDABLE



AB-RE A4

Inoxidable A4

CÓDIGO	MEDIDA	ØD(mm)	€/100	MEDIDA EN PULGADAS	CARGA MÁXIMA		
ABREA4018	18 (M8+M10)	15 - 18	443,636	3/8"	150	50	300
ABREA4022	22 (M8+M10)	20 - 24	455,645	1/2"	150	50	200
ABREA4028	28 (M8+M10)	26 - 30	486,630	3/4"	150	50	150
ABREA4035	35 (M8+M10)	32 - 36	538,263	1"	150	50	100
ABREA4040	40 (M8+M10)	36 - 42	561,349	1 1/4"	150	25	100
ABREA4048	48 (M8+M10)	47 - 50	623,794	1 1/2"	150	25	100
ABREA4054	54 (M8+M10)	51 - 55	650,789	-	150	25	75
ABREA4060	60 (M8+M10)	60 - 64	674,464	2"	150	25	75
ABREA4075	75 (M8+M10)	75 - 80	769,698	2 1/2"	150	25	50
ABREA4090	90 (M8+M10)	87 - 92	797,127	3"	150	25	-
ABREA4110	110 (M8+M10)	106 - 112	944,903	-	150	25	-
ABREA4115	115 (M8+M10)	114 - 119	1.013,731	4"	150	25	-
ABREA4125	125 (M8+M10)	124 - 131	1.056,970	4 1/2"	150	25	-
ABREA4140	140 (M8+M10)	133 - 140	1.286,906	5"	150	25	-
ABREA4160	160 (M8+M10)	159 - 163	1.373,386	-	150	25	-
ABREA4200	200 (M8+M10)	199 - 212	1.714,166	-	150	25	-



EJEMPLOS DE APLICACIÓN



AB-RI

Abrazadera isofónica reforzada M8 + M10

AB-RI

Cincada

02 Info. Técnica P. 413

SANEAMIENTO



EJEMPLOS DE APLICACIÓN



CÓDIGO	MEDIDA	ØD(MM)	€/100	MEDIDA EN PULGADAS	CARGA MÁXIMA		
ABRI018	18 (M8+M10)	15 - 19	119,333	3/8"	80	50	200
ABRI022	22 (M8+M10)	20 - 25	128,365	1/2"	80	50	150
ABRI028	28 (M8+M10)	26 - 30	136,876	3/4"	80	50	150
ABRI035	35 (M8+M10)	32 - 36	146,389	1"	80	50	100
ABRI040	40 (M8+M10)	38 - 43	166,179	1 1/4"	80	25	75
ABRI048	48 (M8+M10)	47 - 51	177,439	1 1/2"	80	25	75
ABRI054	54 (M8+M10)	53 - 56	193,014	-	80	25	50
ABRI060	60 (M8+M10)	60 - 64	206,796	2"	80	25	50
ABRI070	70 (M8+M10)	68 - 72	223,196	-	80	25	-
ABRI075	75 (M8+M10)	75 - 80	233,583	2 1/2"	150	25	-
ABRI083	83 (M8+M10)	81 - 86	253,950	-	150	25	-
ABRI090	90 (M8+M10)	87 - 92	265,484	3"	150	25	-
ABRI100	100 (M8+M10)	99 - 105	290,237	3 1/2"	150	25	-
ABRI110	110 (M8+M10)	107 - 112	323,408	-	150	25	-
ABRI115	115 (M8+M10)	113 - 118	346,882	4"	200	25	-
ABRI125	125 (M8+M10)	125 - 130	371,738	4 1/2"	200	25	-
ABRI133	133 (M8+M10)	132 - 137	388,563	-	200	25	-
ABRI140	140 (M8+M10)	138 - 142	436,815	5"	200	25	-
ABRI150	150 (M8+M10)	148 - 152	446,468	-	200	25	-
ABRI160	160 (M8+M10)	159 - 166	482,516	6"	200	25	-
ABRI180	180 (M8+M10)	179 - 184	505,370	-	200	25	-
ABRI200	200 (M8+M10)	196 - 203	559,747	-	200	25	-
ABRI220	220 (M8+M10)	215 - 226	642,673	8"	200	25	-
ABRI250	250 (M8+M10)	245 - 254	708,340	-	200	25	-
ABRI280	280 (M8+M10)	278 - 284	772,350	-	200	25	-
ABRI300	300 (M8+M10)	299 - 304	822,193	-	200	25	-
ABRI315	315 (M8+M10)	314 - 319	915,393	-	200	25	-
ABRI355	355 (M8+M10)	354 - 359	1.287,527	-	200	25	-

Bolsa autoservicio

CÓDIGO	MEDIDA	€/BOLSA	PCS	BOLSAS
LSABRIT022	22 (M8+M10)	4,600	2	5
LSABRIT028	28 (M8+M10)	4,731	2	5
LSABRIT035	35 (M8+M10)	4,891	2	5
LSABRIT040	40 (M8+M10)	4,891	2	5
LSABRIT048	48 (M8+M10)	5,071	2	5
LSABRIT060	60 (M8+M10)	5,421	2	5
LSABRIT075	75 (M8+M10)	5,846	2	5
LSABRIT090	90 (M8+M10)	6,718	2	5
LSABRIT110	110 (M8+M10)	7,871	2	4

KIT AB-RI + ES-DR + T4S



AB-RI V

Cincada. Ventilación

SANEAMIENTO



CÓDIGO	MEDIDA	ØD(mm)	€/100	MEDIDA EN PULGADAS	CARGA MÁXIMA	
ABRI400	400 (M8+M10)	399 - 404	1.383,485	-	200	25
ABRI450	450 (M8+M10)	449 - 454	1.682,890	-	200	10
ABRI500	500 (M8+M10)	499 - 504	1.727,080	-	200	10
ABRI560	560 (M8+M10)	555 - 561	1.916,793	-	200	10
ABRI600	600 (M8+M10)	599 - 604	2.071,821	-	200	10
ABRI630	630 (M8+M10)	625 - 631	2.203,667	-	200	10
ABRI710	710 (M8+M10)	705 - 711	2.660,003	-	200	10
ABRI800	800 (M8+M10)	799 - 804	2.890,420	-	200	10
ABRI900	900 (M8+M10)	899 - 904	3.281,037	-	200	10
ABRI910	1000 (M8+M10)	999 - 1.004	3.627,900	-	200	10
ABRI911	1120 (M8+M10)	1.115 - 1.121	4.007,920	-	200	10
ABRI912	1250 (M8+M10)	1.245 - 1.251	4.477,255	-	200	10

Abrazadera isofónica reforzada M8 + M10

AB-RI

02 Info
P. 614 Técnica

INOXIDABLE



AB-RI A2

Inoxidable A2

CÓDIGO	MEDIDA	ØD(mm)	€/100	MEDIDA EN PULGADAS	CARGA MÁXIMA		
ABRIA2018	18 (M8+M10)	15 - 18	447,180	3/8"	150	50	200
ABRIA2022	22 (M8+M10)	20 - 24	459,518	1/2"	150	50	150
ABRIA2028	28 (M8+M10)	26 - 30	479,962	3/4"	150	50	150
ABRIA2035	35 (M8+M10)	32 - 36	504,966	1"	150	50	100
ABRIA2040	40 (M8+M10)	36 - 42	554,972	1 1/4"	150	25	75
ABRIA2048	48 (M8+M10)	47 - 50	588,180	1 1/2"	150	25	75
ABRIA2054	54 (M8+M10)	51 - 55	633,759	-	150	25	50
ABRIA2060	60 (M8+M10)	60 - 64	668,165	2"	150	25	50
ABRIA2075	75 (M8+M10)	75 - 80	752,739	2 1/2"	150	25	-
ABRIA2090	90 (M8+M10)	87 - 92	791,252	3"	150	25	-
ABRIA2110	110 (M8+M10)	106 - 112	902,766	-	150	25	-
ABRIA2115	115 (M8+M10)	114 - 119	885,612	4"	150	25	-
ABRIA2125	125 (M8+M10)	124 - 131	981,778	4 1/2"	150	25	-
ABRIA2140	140 (M8+M10)	133 - 140	1.057,112	5"	150	25	-
ABRIA2160	160 (M8+M10)	159 - 163	1.161,578	6"	150	25	-



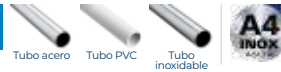

02 Info
P. 614 Técnica

INOXIDABLE



AB-RI A4

Inoxidable A4

CÓDIGO	MEDIDA	ØD(mm)	€/100	MEDIDA EN PULGADAS	CARGA MÁXIMA		
ABRIA4018	18 (M8+M10)	15 - 18	561,302	3/8"	150	50	200
ABRIA4022	22 (M8+M10)	20 - 24	590,094	1/2"	150	50	150
ABRIA4028	28 (M8+M10)	26 - 30	615,950	3/4"	150	50	150
ABRIA4035	35 (M8+M10)	32 - 36	662,075	1"	150	50	100
ABRIA4040	40 (M8+M10)	36 - 42	713,620	1 1/4"	150	25	75
ABRIA4048	48 (M8+M10)	47 - 50	767,222	1 1/2"	150	25	75
ABRIA4054	54 (M8+M10)	51 - 55	805,178	-	150	25	50
ABRIA4060	60 (M8+M10)	60 - 64	880,125	2"	150	25	50
ABRIA4075	75 (M8+M10)	75 - 80	962,951	2 1/2"	150	25	-
ABRIA4090	90 (M8+M10)	87 - 92	1.056,571	3"	150	25	-
ABRIA4110	110 (M8+M10)	106 - 112	1.245,743	-	150	25	-
ABRIA4115	115 (M8+M10)	114 - 119	1.295,096	4"	150	25	-
ABRIA4125	125 (M8+M10)	124 - 131	1.372,003	4 1/2"	150	25	-
ABRIA4140	140 (M8+M10)	133 - 140	1.420,219	5"	150	25	-
ABRIA4160	160 (M8+M10)	159 - 163	1.669,673	6"	150	25	-



EJEMPLOS DE APLICACIÓN



AB-RI DES

Abrazadera isofónica reforzada deslizante M8+M10



CÓDIGO	MEDIDA	€/100	
ABRID016	16	188,381	150
ABRID020	20	196,227	100
ABRID025	25	208,000	100
ABRID032	32	227,626	100
ABRID040	40	247,245	50
ABRID050	50	329,090	50
ABRID063	63	396,378	50
ABRID075	75	451,322	50
ABRID090	90	498,416	50
ABRID110	110	647,552	25
ABRID125	125	784,909	25
ABRID140	140	832,003	20
ABRID160	160	961,514	20

PA-EX

Patin de expansión



CÓDIGO	MEDIDA	€/100	
PAEXM08	M8 x 180	3.579,107	50
PAEXM10	M10 x 180	3.579,107	50

CO-AR

Colgador articulado



CÓDIGO	MEDIDA	€/100		
COAR08060	M8 x 60	233,874	50	300
COAR10060	M10 x 60	359,806	50	300

AB-ICP

Abrazadera isofónica reforzada para cargas pesadas



CÓDIGO	MEDIDA	ØD(mm)	€/100	
ABICP060	60 (M8+M10)	60 - 64	923,118	25
ABICP075	75 (M10+M12)	75 - 80	1.163,884	25
ABICP090	90 (M10+M12)	87 - 92	1.269,688	25
ABICP110	110 (M10+M12)	107 - 112	1.454,856	25
ABICP140	140 (M12+M16)	138 - 142	2.539,386	25
ABICP160	160 (M12+M16)	159 - 166	2.923,204	25
ABICP220	220 (M12+M16)	215 - 226	3.846,325	10
ABICP270	270 (M12+M16)	268 - 274	4.819,122	10
ABICP315	315 (M12+M16)	314 - 319	5.464,983	10

Abrazadera aislante térmica

AB-AIS



AB-AIS 13

13 mm

CÓDIGO	MEDIDA	€/100	ESPEJOR AISLANTE (MM)	
ABAI513010	Ø10	852,977	13	50
ABAI513012	Ø12	874,847	13	50
ABAI513015	Ø15	896,717	13	50
ABAI513018	Ø18	962,333	13	50
ABAI513022	Ø22	1.027,947	13	50
ABAI513028	Ø28	1.071,687	13	50



AB-AIS 19

19 mm

CÓDIGO	MEDIDA	€/100	ESPEJOR AISLANTE (MM)	
ABAI519010	Ø10	1.049,817	19	50
ABAI519012	Ø12	1.071,687	19	50
ABAI519015	Ø15	1.137,303	19	50
ABAI519017	Ø17	1.137,303	19	50
ABAI519018	Ø18	1.159,170	19	50
ABAI519022	Ø22	1.181,040	19	50
ABAI519028	Ø28	1.268,527	19	50
ABAI519035	Ø35	1.356,010	19	50
ABAI519042	Ø42	1.465,370	19	25
ABAI519054	Ø54	1.662,213	19	25
ABAI519060	Ø60	1.837,180	19	25
ABAI519064	Ø64	2.012,150	19	25
ABAI519067	Ø67	2.143,377	19	25
ABAI519076	Ø76	2.296,473	19	25
ABAI519080	Ø80	2.405,827	19	25
ABAI519114	Ø114	3.280,673	19	10



AB-AIS 30

30 mm

CÓDIGO	MEDIDA	€/100	ESPEJOR AISLANTE (MM)	
ABAI530027	Ø27	1.596,597	30	50
ABAI530034	Ø34	1.727,823	30	50
ABAI530042	Ø42	1.837,180	30	25
ABAI530049	Ø49	1.902,793	30	25
ABAI530054	Ø54	2.296,473	30	25
ABAI530060	Ø60	2.340,220	30	25
ABAI530076	Ø76	2.449,573	30	25
ABAI530089	Ø89	2.602,667	30	25
ABAI530108	Ø108	3.608,743	30	10
ABAI530114	Ø114	3.718,100	30	10



AB-AIS 40

40 mm

CÓDIGO	MEDIDA	€/100	ESPEJOR AISLANTE (MM)	
ABAI540049	Ø49	2.383,957	40	25
ABAI540060	Ø60	2.799,510	40	25
ABAI540089	Ø89	3.368,160	40	25
ABAI540114	Ø114	5.249,080	40	10
ABAI540133	Ø133	5.664,637	40	10
ABAI540140	Ø140	6.123,927	40	10
ABAI540159	Ø159	6.998,777	40	10
ABAI540168	Ø168	7.436,200	40	10
ABAI540219	Ø219	8.967,180	40	5



AB-GA

Abrazadera gásmica M8 + M10 amarilla

02 Info. Técnica
P. 415

SANEAMIENTO

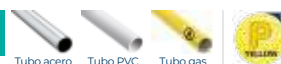

CÓDIGO	MEDIDA	ØD(mm)	€/100	MEDIDA EN PULGADAS	CARGA MÁXIMA		
ABGA018	18 (M8)	15 - 18	101,093	3/8"	200	50	300
ABGA022	22 (M8)	20 - 24	106,563	1/2"	200	50	200
ABGA028	28 (M8)	26 - 30	113,300	3/4"	200	50	150
ABGA035	35 (M8)	32 - 36	121,470	1"	200	50	100
ABGA040	40 (M8)	38 - 42	127,777	1 1/4"	200	50	100
ABGA048	48 (M8)	47 - 50	134,237	1 1/2"	200	50	100
ABGA054	54 (M8)	52 - 56	142,940	-	200	25	75
ABGA060	60 (M8/M10)	60 - 64	152,947	2"	200	25	75
ABGA075	75 (M8/M10)	75 - 80	182,777	2 1/2"	200	25	50
ABGA090	90 (M8/M10)	85 - 90	193,153	3"	200	25	-
ABGA100	100 (M8/M10)	99 - 105	212,240	3 1/2"	200	25	-
ABGA110	110 (M8/M10)	107 - 112	240,363	-	200	25	-
ABGA115	115 (M8/M10)	113 - 118	243,627	4"	200	25	-
ABGA140	140 (M8/M10)	138 - 142	285,920	5"	200	25	-
ABGA160	160 (M8/M10)	159 - 166	301,690	6"	200	25	-

Bolsa autoservicio

CÓDIGO	MEDIDA	€/BOLSA	PCS	BOLSAS
LSABGAT022	22 (M8)	4,675	2	6
LSABGAT028	28 (M8)	4,771	2	6
LSABGAT035	35 (M8)	4,694	2	6
LSABGAT040	40 (M8)	5,052	2	6
LSABGAT048	48 (M8)	4,960	2	6
LSABGAT060	60 (M8/M10)	5,306	2	6
LSABGAT075	75 (M8/M10)	5,683	2	6
LSABGAT090	90 (M8/M10)	6,228	2	6
LSABGAT110	110 (M8/M10)	8,419	2	5

KIT
AB-GA + ES-DR
+ T4S



EJEMPLOS DE APLICACIÓN



AB-M8

Abrazadera desagüe M8

02 Info. Técnica
P. 415

SANEAMIENTO



CÓDIGO	MEDIDA	ØD(mm)	€/100	CARGA MÁXIMA	
ABM8050	50 (M8)	49 - 54	139,290	100	100
ABM8063	63 (M8)	60 - 65	132,702	100	100
ABM8075	75 (M8)	75 - 80	139,873	100	100
ABM8090	90 (M8)	88 - 92	149,583	100	100
ABM8110	110 (M8)	108 - 113	163,667	100	100
ABM8125	125 (M8)	124 - 130	175,325	100	100
ABM8160	160 (M8)	159 - 165	239,053	100	100
ABM8200	200 (M8)	199 - 203	278,147	100	100
ABM8250	250 (M8)	249 - 254	369,988	100	50
ABM8315	315 (M8)	314 - 319	806,180	100	50

Bolsa autoservicio

CÓDIGO	MEDIDA	€/BOLSA	PCS	BOLSAS
LSABM8090	90 (M8)	3,773	2	6
LSABM8110	110 (M8)	3,937	2	6
LSABM8125	125 (M8)	2,691	1	8
LSABM8160	160 (M8)	3,463	1	4

Abrazadera desagüe de empotrar

AB-DE

 Info Técnica
P. 416

SANEAMIENTO



CÓDIGO	MEDIDA	ØD(mm)	€/100	CARGA MÁXIMA	
ABDE075	75	75 - 80	232,780	200	100
ABDE090	90	87 - 92	252,020	200	100
ABDE110	110	107 - 112	304,520	200	100
ABDE125	125	125 - 130	343,027	200	50

AB-DE Z

Cincada



 Info Técnica
P. 416

SANEAMIENTO



CÓDIGO	MEDIDA	ØD(mm)	€/100	CARGA MÁXIMA	
ABDE160	160	159 - 166	399,027	200	50
ABDE200	200	199 - 212	479,533	200	50
ABDE250	250	245 - 254	770,053	200	25
ABDE315	315	314 - 319	966,073	200	25

AB-DE G

Recubrimiento ATLANTIS C2-L



EJEMPLOS DE APLICACIÓN



Abrazadera desagüe con pie

AB-DP

 Info Técnica
P. 416

SANEAMIENTO



CÓDIGO	MEDIDA	ØD(mm)	€/100	CARGA MÁXIMA	
ABDP075	75	75 - 80	266,023	200	100
ABDP090	90	87 - 92	290,523	200	100
ABDP110	110	107 - 112	317,820	200	100
ABDP125	125	125 - 130	357,027	200	50

AB-DP Z

Cincada



 Info Técnica
P. 416

SANEAMIENTO



CÓDIGO	MEDIDA	ØD(mm)	€/100	CARGA MÁXIMA	
ABDP160	160	159 - 166	427,030	200	50
ABDP200	200	199 - 212	504,037	200	25
ABDP250	250	245 - 254	700,057	200	25

AB-DP G

Recubrimiento ATLANTIS C2-L



EJEMPLOS DE APLICACIÓN



AB-ZI

Abarcón

AB-ZI

Cincada

02
P. 417 Info.
Técnica

SANEAMIENTO



CÓDIGO	MEDIDA	€/100	CARGA MÁXIMA	Ø VARILLA PULGADAS		
AZIM060250	M6 1/4"	28,019	250	1/4"	100	800
AZIM060375	M6 3/8"	28,998	250	3/8"	100	1.200
AZIM060500	M6 1/2"	33,280	250	1/2"	100	600
AZIM060750	M6 3/4"	39,379	250	3/4"	100	600
AZIM061000	M6 1"	42,294	250	1"	100	400
AZIM061250	M6 1 1/4"	56,576	250	1 1/4"	50	300
AZIM081500	M8 1 1/2"	87,827	350	1 1/2"	50	150
AZIM082000	M8 2"	100,109	350	2"	50	150
AZIM082250	M8 2 1/4"	117,803	350	2 1/4"	50	100
AZIM082500	M8 2 1/2"	122,858	350	2 1/2"	50	100
AZIM083000	M8 3"	131,734	350	3"	50	100
AZIM083500	M8 3 1/2"	156,925	350	3 1/2"	50	100
AZIM084000	M8 4"	193,680	350	4"	50	100
AZIM084500	M8 4 1/2"	204,845	350	4 1/2"	25	100
AZIM085000	M8 5"	212,013	350	5"	25	100
AZIM086000	M8 6"	241,037	350	6"	25	100
AZIM103000	M10 3"	189,296	350	3"	25	50
AZIM103500	M10 3 1/2"	218,452	350	3 1/2"	25	50
AZIM104000	M10 4"	244,126	350	4"	25	100
AZIM105000	M10 5"	270,679	350	5"	25	100
AZIM106000	M10 6"	313,100	350	6"	25	100
AZIM108000	M10 8"	367,283	350	8"	25	100

AB-ZI A2

Inoxidable A2

SANEAMIENTO



CÓDIGO	MEDIDA	€/100	CARGA MÁXIMA		
AZA2060500	M6 1/2"	109,780	250	100	600
AZA2060750	M6 3/4"	127,623	250	100	600
AZA2061000	M6 1"	157,233	250	100	400
AZA2061250	M6 1 1/4"	186,167	250	50	300
AZA2081500	M8 1 1/2"	323,520	350	50	150
AZA2082000	M8 2"	376,290	350	50	150
AZA2082500	M8 2 1/2"	423,973	350	50	100
AZA2083000	M8 3"	460,830	350	50	100
AZA2104000	M10 4"	937,600	350	50	-
AZA2106000	M10 6"	1.209,237	350	25	-
AZA2108000	M10 8"	1.446,647	350	25	-

Soporte de abarcón

AB-SA

 Info Técnica
P. 417

SANEAMIENTO



CÓDIGO	MEDIDA	€/100	LONGITUD	
ABSA050100	50 x 100	494,557	100	50
ABSA050125	50 x 125	535,987	125	50
ABSA050200	50 x 200	669,025	200	25
ABSA050300	50 x 300	792,367	300	25
ABSA050400	50 x 400	968,060	400	25
ABSA050500	50 x 500	1.414,267	500	10
ABSA050600	50 x 600	1.585,106	600	10
ABSA100100	100 x 100	677,742	100	25
ABSA100125	100 x 125	704,803	125	25
ABSA100200	100 x 200	859,375	200	25
ABSA100300	100 x 300	1.056,510	300	10
ABSA100400	100 x 400	1.413,157	400	10
ABSA100500	100 x 500	1.847,190	500	10





Abrazadera de gran presión

AB-GP

 Info Técnica
P. 418

SANEAMIENTO



CÓDIGO	MEDIDA	ØD(mm)	€/100		
AGP023025	23-25	23 - 25	148,371	50	300
AGP026028	26-28	26 - 28	154,272	50	300
AGP029031	29-31	29 - 31	183,467	50	200
AGP032035	32-35	32 - 35	190,461	50	150
AGP036039	36-39	36 - 39	193,732	50	150
AGP040043	40-43	40 - 43	205,246	50	100
AGP044047	44-47	44 - 47	263,530	50	-
AGP048051	48-51	48 - 51	275,079	25	75
AGP052055	52-55	52 - 55	281,156	25	75
AGP056059	56-59	56 - 59	287,834	25	75
AGP060063	60-63	60 - 63	299,994	25	50
AGP064067	64-67	64 - 67	339,122	25	50
AGP068073	68-73	68 - 73	404,960	25	-
AGP074079	74-79	74 - 79	409,976	25	-
AGP080085	80-85	80 - 85	414,235	25	-
AGP086091	86-91	86 - 91	422,095	25	-
AGP092097	92-97	92 - 97	442,573	25	-
AGP098103	98-103	98 - 103	447,165	25	-
AGP104112	104-112	104 - 112	485,618	25	-
AGP113121	113-121	113 - 121	518,630	25	-
AGP122130	122-130	122 - 130	556,662	25	-
AGP131139	131-139	131 - 139	694,570	25	-
AGP140148	140-148	140 - 148	709,615	25	-
AGP149161	149-161	149 - 161	751,833	25	-
AGP162174	162-174	162 - 174	784,839	25	-



EJEMPLOS DE APLICACIÓN























 Blíster



























CÓDIGO	MEDIDA	€/BOLSA	PCS 	BOLSAS 
BZAGP023025	23-25	4,463	2	10
BZAGP029031	29-31	4,463	2	10
BZAGP040043	40-43	4,463	2	10



ABRAZADERAS METÁLICAS LIGERAS



MEDIDAS (mm)	CARGA RECOMENDADA kg	RECUBRIMIENTO	ESPESOR (mm)	ANCHURA (mm)	APERTURA	MANGUITO	HOMOLOGACIÓN	ISOFÓNICA	CTE	MONTAJE EN PARALELO	TORNILLO
AB-M6 APLICACIONES: Gas, Saneamiento, Eléctrico P. 264											
AB-M6 Z											
	Ø 8 - Ø 63	70 - 100	 AB-M6 AB-M6 Z	1 - 1,2	12	Rápida lateral	Embutida M6	-	-	-	-
AB-M7 Z APLICACIONES: Gas Saneamiento Eléctrico P. 267											
	Ø 8 - Ø 63	70	 Z ZINC	0,8 - 1	11	-	Embutida M7	-	-	-	-
AB-D6 APLICACIONES: Gas, Saneamiento, Eléctrico P. 265											
AB-D6 Z											
	Ø 12 - Ø 28	100	 AB-D6 AB-D6 Z	1	12	-	Embutida M6	-	-	✓	-
AB-DZ 7 APLICACIONES: Gas, Saneamiento, Eléctrico P. 267											
	Ø 10 - Ø 28	70	 Z ZINC	0,8 - 1	11	-	Embutida M7	-	-	✓	-
AB-6I APLICACIONES: ACS y AF, Gas, Saneamiento, Calefacción, Climatización, Eléctrico, Ventilación P. 266											
	Ø 12 - Ø 60	70 - 100	 B YELLOW	1 - 1,2	12	Rápida lateral	Embutida M6	-	✓	✓	-
AB-DI APLICACIONES: ACS y AF, Gas, Saneamiento, Calefacción, Climatización, Eléctrico, Ventilación P. 266											
	Ø 12 - Ø 60	100	 B YELLOW	1	12	-	Embutida M6	-	✓	✓	✓
AB-7I Z APLICACIONES: ACS y AF, Gas, Saneamiento, Calefacción, Climatización, Eléctrico, Ventilación P. 268											
	Ø 12 - Ø 50	70	 Z ZINC	0,8 - 1	11	-	Embutida M7	-	✓	✓	-
AB-7ID Z APLICACIONES: ACS y AF, Gas, Saneamiento, Calefacción, Climatización, Eléctrico, Ventilación P. 268											
	Ø 10 - Ø 28	70	 Z ZINC	0,8 - 1	11	-	Embutida M7	-	✓	✓	✓
AB-PI APLICACIONES: Saneamiento, Eléctrico P. 269											
	Ø 6 - Ø 63	30	 Z ZINC	1,1 - 1,3	12,5 - 19	-	-	-	-	-	-
AB-PU APLICACIONES: Saneamiento, Eléctrico P. 269											
	Ø 16 - Ø 63	30	 Z ZINC	1,2 - 1,4	12 - 20	-	-	-	-	-	-

MEDIDAS (mm)	CARGA RECOMENDADA kg	RECUBRIMIENTO	ESPESOR (mm)	ANCHURA (mm)	APERTURA	MANGUITO	HOMOLOGACIÓN	ISO FÓNICA	CTE	MONTAJE EN PARALELO	TORNILLO	
AB-GM APLICACIONES: Gas P. 274												
	Ø 12 - Ø 35	100		1 - 1,2	12	Rápida lateral	Embutida M6	De acuerdo a UNE-EN ISO 4892	-	-	-	Premontado
AB-GS APLICACIONES: Gas P. 275												
	Ø 10 - Ø 54	70 - 100		1 - 1,2	12	Rápida lateral	Embutida M6	De acuerdo a UNE-EN ISO 4892	-	-	-	Premontado
AB-GD APLICACIONES: Gas P. 275												
	Ø 12 - Ø 28	100		1 - 1,2	12	-	Embutida M6	De acuerdo a UNE-EN ISO 4892	-	-		Premontado
AB-CR APLICACIONES: Saneamiento P. 273												
	Ø 10 - Ø 12	70		1 - 1,2	12	Rápida lateral	Embutida M6	-	-	-	-	-
AB-ITS P. 273												
	15 - 28	-		1,0 - 1,2	20 - 33	-	-	-	-	-	-	-
AB-ITD P. 273												
	15 - 22	-		1,0	20 - 27	-	-	-	-	-	-	-
AB-BU APLICACIONES: Saneamiento, Industrial P. 274												
	Ø 13 - Ø 21	-		0,6	9	-	-	-	-	-	-	Premontado
AB-SF APLICACIONES: Saneamiento, Industrial P. 271												
	Ø 8 - Ø 150	-		0,6 - 0,8	9	-	-	-	-	-	-	Premontado
AB-IP APLICACIONES: ACS y AF, Gas, Saneamiento, Calefacción, Climatización, Eléctrico, Ventilación P. 270												
	-	-		1,5	20	-	-	-			-	ABT006015
AB-SI APLICACIONES: ACS y AF, Gas, Saneamiento, Calefacción, Climatización, Eléctrico, Ventilación P. 270												
	3 / 25 Agujeros	-		3	20	-	-	-				ABT006015

AB-M6

Abrazadera M6

AB-M6

Bicromatada



02 Info. Técnica P. 418

SANEAMIENTO



CÓDIGO	MEDIDA	ØD(mm)	€/100	MEDIDA EN PULGADAS	CARGA MÁXIMA		
ABM6008	8 (M6)	8	19,160	-	70	100	1.200
ABM6010	10 (M6)	10	19,146	1/8"	70	100	1.200
ABM6012	12 (M6)	12	19,306	-	70	100	1.200
ABM6014	14 (M6)	14	20,081	1/4"	70	100	1.200
ABM6015	15 (M6)	15	20,087	-	70	100	600
ABM6016	16 (M6)	16	20,860	-	70	100	600
ABM6018	18 (M6)	18	20,939	3/8"	70	100	600
ABM6020	20 (M6)	20	21,473	-	70	100	600
ABM6022	22 (M6)	22	22,217	1/2"	70	100	600
ABM6025	25 (M6)	25	23,337	-	70	100	600
ABM6026	26 (M6)	26	23,920	3/4"	70	100	400
ABM6028	28 (M6)	28	24,624	-	70	100	400
ABM6032	32 (M6)	32	27,267	1"	70	50	300
ABM6035	35 (M6)	35	30,809	-	70	50	300
ABM6037	37 (M6)	37	32,503	-	100	50	300
ABM6040	40 (M6)	40	34,393	-	100	50	300
ABM6042	42 (M6)	42	35,673	1 1/4"	100	50	300
ABM6047	47 (M6)	47	38,789	1 1/2"	100	50	200
ABM6050	50 (M6)	50	39,357	-	100	50	150
ABM6054	54 (M6)	54	44,807	-	100	50	150
ABM6060	60 (M6)	60	51,127	2"	100	50	150
ABM6063	63 (M6)	63	52,336	-	100	50	100

Bolsa autoservicio

CÓDIGO	MEDIDA	€/BOLSA	PCS	BOLSAS
LSABM6012	12 (M6)	5,701	20	5
LSABM6014	14 (M6)	5,811	20	5
LSABM6016	16 (M6)	5,916	20	5

Bolsa autoservicio

CÓDIGO	MEDIDA	€/BOLSA	PCS	BOLSAS
LSABM6018	18 (M6)	4,939	15	6
LSABM6022	22 (M6)	4,125	10	6
LSABM6028	28 (M6)	3,007	6	6

Bolsa autoservicio

CÓDIGO	MEDIDA	€/BOLSA	PCS	BOLSAS
LSABM6032	32 (M6)	2,672	4	6
LSABM6040	40 (M6)	3,069	4	5

AB-M6 Z

Cincada



02 Info. Técnica P. 418

SANEAMIENTO



CÓDIGO	MEDIDA	ØD(mm)	€/100	MEDIDA EN PULGADAS	CARGA MÁXIMA		
ABMZ6008	8 (M6)	8	19,160	-	70	100	1.200
ABMZ6010	10 (M6)	10	19,146	1/8"	70	100	1.200
ABMZ6012	12 (M6)	12	19,306	-	70	100	1.200
ABMZ6014	14 (M6)	14	20,081	1/4"	70	100	1.200
ABMZ6015	15 (M6)	15	20,087	-	70	100	600
ABMZ6016	16 (M6)	16	20,860	-	70	100	600
ABMZ6018	18 (M6)	18	20,939	3/8"	70	100	600
ABMZ6020	20 (M6)	20	21,473	-	70	100	600
ABMZ6022	22 (M6)	22	22,217	1/2"	70	100	600
ABMZ6025	25 (M6)	25	23,337	-	70	100	600
ABMZ6026	26 (M6)	26	23,920	3/4"	70	100	400
ABMZ6028	28 (M6)	28	24,624	-	70	100	400
ABMZ6032	32 (M6)	32	27,267	1"	70	50	300
ABMZ6035	35 (M6)	35	30,809	-	70	50	300
ABMZ6037	37 (M6)	37	32,503	-	100	50	300
ABMZ6040	40 (M6)	40	34,393	-	100	50	300
ABMZ6042	42 (M6)	42	35,673	1 1/4"	100	50	300
ABMZ6047	47 (M6)	47	38,789	1 1/2"	100	50	200
ABMZ6050	50 (M6)	50	39,357	-	100	50	150
ABMZ6054	54 (M6)	54	44,807	-	100	50	150
ABMZ6060	60 (M6)	60	51,127	2"	100	50	150
ABMZ6063	63 (M6)	63	52,336	-	100	50	100

Abrazadera M6

AB-M6

 Info Técnica
P. 419

INOXIDABLE



AB-M6 A2

Inoxidable A2

CÓDIGO	MEDIDA	ØD(mm)	€/100	MEDIDA EN PULGADAS	CARGA MÁXIMA		
ABM6A2012	12 (M6)	12	269,863	1/4"	70	100	1.200
ABM6A2015	15 (M6)	14 - 15	274,740	-	70	100	600
ABM6A2018	18 (M6)	16 - 18	279,617	3/8"	70	100	600
ABM6A2020	20 (M6)	19 - 21	285,207	1/2"	70	100	600
ABM6A2022	22 (M6)	22 - 24	288,820	-	70	100	600
ABM6A2028	28 (M6)	25 - 30	305,037	3/4"	70	100	400



Abrazadera doble M6

AB-D6

 Info Técnica
P. 419

SANEAMIENTO



AB-D6

Bicromatada

CÓDIGO	MEDIDA	ØD(mm)	€/100	MEDIDA EN PULGADAS	CARGA MÁXIMA		
ABD6012	12 (M6)	12	29,916	-	100	50	600
ABD6015	15 (M6)	15	33,257	-	100	50	300
ABD6018	18 (M6)	18	36,168	3/8"	100	50	300
ABD6022	22 (M6)	22	41,433	1/2"	100	50	300
ABD6028	28 (M6)	28	47,103	-	100	50	200



 Bolsa autoservicio

CÓDIGO	MEDIDA	€/BOLSA	PCS	BOLSAS
LSABD6012	12 (M6)	3,075	5	6
LSABD6015	15 (M6)	3,176	5	6
LSABD6018	18 (M6)	3,265	5	6
LSABD6022	22 (M6)	3,176	4	6
LSABD6028	28 (M6)	3,905	4	6

 Info Técnica
P. 419

SANEAMIENTO



AB-D6 Z

Cincada

CÓDIGO	MEDIDA	ØD(mm)	€/100	MEDIDA EN PULGADAS	CARGA MÁXIMA		
ABDZ6012	12 (M6)	12	29,916	-	100	50	600
ABDZ6015	15 (M6)	15	33,257	-	100	50	300
ABDZ6018	18 (M6)	18	36,168	3/8"	100	50	300
ABDZ6022	22 (M6)	22	41,433	1/2"	100	50	300
ABDZ6028	28 (M6)	28	47,103	-	100	50	200



EJEMPLOS DE APLICACIÓN



AB-6I

Abrazadera isofónica M6

02 Info. Técnica
P. 420

SANEAMIENTO



CÓDIGO	MEDIDA	ØD(mm)	€/100	MEDIDA EN PULGADAS	CARGA MÁXIMA		
AB6I012	12 (M6)	12	29,650	1/8"	70	100	600
AB6I015	15 (M6)	15	30,477	1/4"	70	100	600
AB6I016	16 (M6)	16	31,830	-	70	100	600
AB6I018	18 (M6)	18	32,107	3/8"	70	100	600
AB6I022	22 (M6)	22	36,533	1/2"	70	100	400
AB6I026	26 (M6)	26	41,410	-	70	100	400
AB6I028	28 (M6)	28	43,080	3/4"	70	100	300
AB6I032	32 (M6)	32	45,107	-	70	50	200
AB6I035	35 (M6)	35	50,863	1"	70	50	200
AB6I042	42 (M6)	42	62,887	1 1/4"	100	50	150
AB6I048	48 (M6)	48	71,190	1 1/2"	100	50	100
AB6I054	54 (M6)	54	84,083	-	100	50	100
AB6I060	60 (M6)	60	89,317	2"	100	50	100

02 Bolsa autoservicio

CÓDIGO	MEDIDA	€/BOLSA	PCS	BOLSAS
LSAB6I012	12 (M6)	4,739	10	6
LSAB6I015	15 (M6)	4,984	10	5
LSAB6I016	16 (M6)	5,012	10	6
LSAB6I018	18 (M6)	4,058	8	6
LSAB6I022	22 (M6)	3,704	6	6
LSAB6I028	28 (M6)	3,343	4	6

AB-DI

Abrazadera doble isofónica M6

02 Info. Técnica
P. 420

SANEAMIENTO



CÓDIGO	MEDIDA	ØD(mm)	€/100	MEDIDA EN PULGADAS	CARGA MÁXIMA		
ABDI0012	12 (M6)	12	53,167	1/8"	100	50	300
ABDI0015	15 (M6)	15	62,145	1/4"	100	50	300
ABDI0018	18 (M6)	18	67,813	3/8"	100	50	200
ABDI0022	22 (M6)	22	79,703	1/2"	100	50	200
ABDI0028	28 (M6)	28	104,017	3/4"	100	50	150

02 Bolsa autoservicio

CÓDIGO	MEDIDA	€/BOLSA	PCS	BOLSAS
LSABDI0012	12 (M6)	3,735	5	6
LSABDI0015	15 (M6)	3,946	5	6
LSABDI0018	18 (M6)	3,212	3	6
LSABDI0022	22 (M6)	3,356	3	6



Abrazadera M7. Cincada

AB-M7 Z

02
P. 421
Info
Técnica

SANEAMIENTO



CÓDIGO	MEDIDA	ØD(mm)	€/100		
ABMZ7008	8	8	19,160	100	1.200
ABMZ7010	10	10	19,146	100	1.200
ABMZ7012	12	12	19,306	100	1.200
ABMZ7014	14	14	20,081	100	1.200
ABMZ7016	16	16	20,860	100	1.200
ABMZ7018	18	18	20,939	100	1.200
ABMZ7020	20	20	21,473	100	1.200
ABMZ7022	22	22	22,217	100	600
ABMZ7024	24	24	23,133	100	600
ABMZ7025	25	25	23,337	100	600
ABMZ7026	26	26	23,920	100	600
ABMZ7028	28	28	24,624	100	600
ABMZ7032	32	32	27,267	50	600
ABMZ7034	34	34	30,809	50	300
ABMZ7036	36	36	32,503	50	300
ABMZ7038	38	38	34,393	50	300
ABMZ7040	40	40	35,673	50	300
ABMZ7050	50	50	39,357	50	200
ABMZ7063	63	63	52,336	25	150





Abrazadera doble M7. Cincada

AB-D7 Z

02
P. 421
Info
Técnica

SANEAMIENTO



CÓDIGO	MEDIDA	ØD(mm)	€/100		
ABDZ70810	8-10	8-10	29,916	50	600
ABDZ71012	10-12	10-12	29,916	50	600
ABDZ71214	12-14	12-14	32,933	50	600
ABDZ71416	14-16	14-16	33,257	50	600
ABDZ71618	16-18	16-18	36,168	50	600
ABDZ71820	18-20	18-20	41,433	50	300
ABDZ72022	20-22	20-22	41,433	50	300
ABDZ72224	22-24	22-24	50,150	50	300
ABDZ72628	26-28	26-28	47,103	50	300



AB-7I Z

Abrazadera isofónica M7. Cincada



SANEAMIENTO



CÓDIGO	MEDIDA	ØD(mm)	€/100		
AB7IZ010	10	10	28,257	100	1.200
AB7IZ012	12	12	29,650	100	1.200
AB7IZ014	14	14	30,477	100	1.200
AB7IZ016	16	16	31,830	100	1.200
AB7IZ018	18	18	32,107	100	600
AB7IZ020	20	20	34,643	100	600
AB7IZ022	22	22	36,533	100	600
AB7IZ024	24	24	37,713	100	600
AB7IZ026	26	26	41,410	100	600
AB7IZ028	28	28	43,080	100	400
AB7IZ032	32	32	45,107	50	300
AB7IZ034	34	34	50,863	50	300
AB7IZ036	36	36	50,863	50	300
AB7IZ038	38	38	51,147	50	300
AB7IZ040	40	40	62,887	50	300
AB7IZ050	50	50	71,190	50	200

AB-7ID Z

Abrazadera doble isofónica M7. Cincada



SANEAMIENTO



CÓDIGO	MEDIDA	ØD(mm)	€/100		
AB7IDZ0810	08-10	08-10	49,710	50	600
AB7IDZ1012	10-12	10-12	53,167	50	600
AB7IDZ1214	12-14	12-14	54,863	50	600
AB7IDZ1416	14-16	14-16	62,145	50	300
AB7IDZ1618	16-18	16-18	67,813	50	300
AB7IDZ1820	18-20	18-20	70,150	50	300
AB7IDZ2022	20-22	20-22	79,703	50	300
AB7IDZ2224	22-24	22-24	84,380	50	200
AB7IDZ2628	26-28	26-28	104,017	50	200

Grapa 1 pie

AB-PI

 Info Técnica
P. 423

SANEAMIENTO



CÓDIGO	MEDIDA	ØD(mm)	€/100	MEDIDA EN PULGADAS	CARGA MÁXIMA		
ABPI006	6	6	5,906	-	30	100	2.400
ABPI008	8	8	6,443	-	30	100	2.400
ABPI010	10	10	7,160	1/8"	30	100	2.400
ABPI012	12	12	7,406	1/4"	30	100	2.400
ABPI014	14	14	9,297	-	30	100	2.400
ABPI016	16	16	11,146	3/8"	30	100	1.200
ABPI018	18	18	12,097	-	30	100	1.200
ABPI020	20	20	14,381	1/2"	30	100	1.200
ABPI022	22	22	15,720	-	30	100	600
ABPI025	25	25	17,530	-	30	100	600
ABPI026	26	26	18,887	3/4"	30	100	600
ABPI028	28	28	19,238	-	30	100	600
ABPI032	32	32	26,007	1"	30	100	600
ABPI040	40	40	35,650	-	30	50	300
ABPI042	42	42	42,037	1 1/4"	30	50	300
ABPI047	47	47	43,807	1 1/2"	30	50	200
ABPI050	50	50	45,310	-	30	50	200
ABPI063	63	63	67,920	2"	30	50	200



EJEMPLOS DE APLICACIÓN



 Blíster

CÓDIGO	MEDIDA	€/BOLSA	PCS B	BOLSAS
BZABPI016	16	1,943	2	15
BZABPI018	18	1,943	2	12
BZABPI020	20	1,943	2	10
BZABPI022	22	1,943	2	10
BZABPI025	25	1,943	2	10
BZABPI028	28	1,943	2	10
BZABPI032	32	1,943	2	10

 Bolsa autoservicio

CÓDIGO	MEDIDA	€/BOLSA	PCS B	BOLSAS
LSABPI016	16	4,373	20	5
LSABPI018	18	4,493	20	5
LSABPI020	20	4,671	20	5
LSABPI022	22	5,115	20	5
LSABPI025	25	4,680	15	5
LSABPI028	28	3,953	10	6
LSABPI032	32	3,277	6	6
LSABPI040	40	3,107	4	6



Grapa puente

AB-PU

 Info Técnica
P. 423

SANEAMIENTO



CÓDIGO	MEDIDA	ØD(mm)	€/100	MEDIDA EN PULGADAS	CARGA MÁXIMA		
ABPU016	16	16	14,181	3/8"	75	100	1.200
ABPU018	18	18	14,854	-	75	100	1.200
ABPU020	20	20	15,487	1/2"	75	100	600
ABPU022	22	22	18,693	-	75	100	600
ABPU025	25	25	19,703	-	75	100	600
ABPU028	28	28	21,280	-	75	100	600
ABPU032	32	32	24,087	1"	75	50	300
ABPU037	37	37	28,240	-	75	50	300
ABPU040	40	40	32,738	-	75	50	300
ABPU050	50	50	42,214	-	75	50	200
ABPU063	63	63	57,238	2"	75	50	150



EJEMPLOS DE APLICACIÓN



 Bolsa autoservicio

CÓDIGO	MEDIDA	€/BOLSA	PCS B	BOLSAS
LSABPU016	16	4,761	20	5
LSABPU018	18	5,033	20	5
LSABPU020	20	5,118	20	5
LSABPU022	22	5,794	20	5
LSABPU025	25	5,086	15	5
LSABPU028	28	4,233	10	6
LSABPU032	32	3,115	6	6
LSABPU037	37	2,799	4	6
LSABPU040	40	2,836	4	6
LSABPU050	50	3,197	4	6
LSABPU063	63	3,476	4	6

AB-IP

Grapa puente isofónica para montaje



SANEAMIENTO



CÓDIGO	MEDIDA	ØD(mm)	€/100	Nº AGUJEROS	MEDIDA EN PULGADAS		
ABIP015	15	15	58,610	3	-	50	600
ABIP018	18	18	64,583	3	3/8"	50	300
ABIP022	22	22	69,446	3	1/2"	50	300
ABIP026	26	26	82,823	4	3/4"	50	300
ABIP028	28	28	88,540	4	-	50	300
ABIP035	35	35	93,648	4	1"	50	150
ABIP042	42	42	104,057	4	1 1/4"	25	100
ABIP048	48	48	112,455	4	1 1/2"	25	100
ABIP054	54	54	122,453	5	-	25	100
ABIP060	60	60	148,290	5	2"	25	75
ABIP067	67	67	164,923	5	-	25	75
ABIP075	75	75	175,943	6	2 1/2"	25	75
ABIP090	90	90	207,930	6	3"	25	75

AB-SI

Soporte para grapa puente isofónica



SANEAMIENTO



AB-SI

Soporte para grapa puente isofónica



CÓDIGO	MEDIDA	MÉTRICA TALADRO	€/100	Nº AGUJEROS		
ABSI003	3	M6	199,107	3	25	-
ABSI004	4	M6	231,777	4	25	-
ABSI005	5	M6	266,423	5	25	150
ABSI006	6	M6	299,993	6	25	-
ABSI007	7	M6	328,927	7	25	-
ABSI008	8	M6	361,159	8	25	-
ABSI009	9	M6	393,604	9	25	-
ABSI010	10	M6	420,953	10	25	-
ABSI011	11	M6	460,283	11	25	-
ABSI012	12	M6	494,723	12	25	-
ABSI013	13	M6	527,000	13	25	-
ABSI014	14	M6	553,970	14	25	-
ABSI015	15	M6	588,850	15	25	-
ABSI016	16	M6	622,003	16	10	-
ABSI017	17	M6	656,068	17	10	-
ABSI018	18	M6	712,378	18	10	-
ABSI019	19	M6	720,715	19	10	-
ABSI020	20	M6	769,065	20	10	-
ABSI021	21	M6	785,248	21	10	-
ABSI022	22	M6	819,012	22	10	-
ABSI025	25	M6	917,389	25	10	-

AB-TO

Tornillo para montaje AB-IP

CÓDIGO	MEDIDA	€/100	
ABTO06015	M6 x 15	8,887	100



EJEMPLOS DE APLICACIÓN



Abrazadera sin fin

AB-SF

02 Info
Técnica
P. 425

SANEAMIENTO



AB-SF

Cincada

CÓDIGO	MEDIDA	ØD(mm)	€/100	MEDIDA EN PULGADAS		
ASF008016	8-16	8-16	30,912	5/16"-5/8"	100	1.200
ASF012022	12-22	12-22	31,899	1/2"-7/8"	100	600
ASF016027	16-27	16-27	33,585	5/8"-1 1/16"	100	600
ASF020032	20-32	20-32	37,658	3/4"-1 1/4"	100	600
ASF025040	25-40	25-40	43,937	1"-1 5/8"	100	400
ASF030045	30-45	30-45	50,050	1 3/16"-1 3/4"	100	300
ASF035050	35-50	35-50	50,343	1 3/8"-2"	100	200
ASF040060	40-60	40-60	58,300	1 5/8"-2 3/8"	100	200
ASF050070	50-70	50-70	64,640	2"-2 3/4"	50	100
ASF060080	60-80	60-80	67,770	2 3/8"-3 1/8"	50	100
ASF070090	70-90	70-90	74,720	2 3/4"-3 1/2"	50	-
ASF080100	80-100	80-100	80,690	3 1/8"-4"	50	-
ASF090110	90-110	90-110	89,473	3 1/2"-4 3/8"	50	-
ASF100120	100-120	100-120	98,200	4"-4 3/4"	25	-
ASF110130	110-130	110-130	101,010	4 3/8"-5 1/8"	25	-
ASF120140	120-140	120-140	107,517	4 3/4"-5 1/2"	25	-
ASF130150	130-150	130-150	111,227	5 1/8"-5 7/8"	25	-



02 Info
Técnica
P. 425

Blíster

CÓDIGO	MEDIDA	€/BOLSA	PCS 	BOLSAS 
BZASF008016	8-16	2,459	2	20
BZASF012022	12-22	2,459	2	20
BZASF016027	16-27	2,459	2	20
BZASF020032	20-32	2,459	2	10
BZASF025040	25-40	2,459	2	10

02 Info
Técnica
P. 425

Bolsa autoservicio

CÓDIGO	MEDIDA	€/BOLSA	PCS 	BOLSAS 
LSASF008016	8-16	6,537	15	7
LSASF012022	12-22	5,716	12	7
LSASF016027	16-27	5,858	12	7
LSASF020032	20-32	5,565	10	7
LSASF025040	25-40	3,878	6	7
LSASF030045	30-45	4,278	6	7
LSASF035050	35-50	4,314	6	7
LSASF040060	40-60	3,541	4	7
LSASF050070	50-70	3,785	4	7



02 Info
Técnica
P. 425

INOXIDABLE



AB-SF A2

Inoxidable A2

CÓDIGO	MEDIDA	ØD(mm)	€/100	MEDIDA EN PULGADAS		
ASF2010016	10-16	10-16	95,663	-	100	1.200
ASF2012020	12-20	12-20	98,043	1/2"-7/8"	100	600
ASF2016027	16-27	16-27	102,270	5/8"-1 1/16"	100	600
ASF2020032	20-32	20-32	115,347	3/4"-1 1/4"	100	600
ASF2025040	25-40	25-40	126,033	1"-1 5/8"	100	200
ASF2032050	32-50	32-50	175,423	1 3/8"-2"	100	300
ASF2040060	40-60	40-60	186,260	1 5/8"-2 3/8"	100	200
ASF2050070	50-70	50-70	194,387	2"-2 3/4"	50	100
ASF2060080	60-80	60-80	204,343	2 3/8"-3 1/8"	50	100
ASF2070090	70-90	70-90	215,207	2 3/4"-3 1/2"	50	100
ASF2080100	80-100	80-100	222,420	3 1/8"-4"	50	100
ASF2090110	90-110	90-110	259,380	3 1/2"-4 3/8"	50	100
ASF2100120	100-120	100-120	269,563	4"-4 3/4"	25	25
ASF2110130	110-130	110-130	279,720	4 3/8"-5 1/8"	25	25
ASF2120140	120-140	120-140	293,967	4 3/4"-5 1/2"	25	25
ASF2130150	130-150	130-150	305,160	5 1/8"-5 7/8"	25	25



EJEMPLOS DE APLICACIÓN



AB-SF IR

Abrazadera sin fin inoxidable en rollo

AB-SF IR

Kit (Rollo 3 m. + 8 cabezales).
Inoxidable



INOXIDABLE



CÓDIGO	MEDIDA	€/PC		
ASFIR03	9 x 0,6 mm/ 3 m	14,867	1	50

AB-SF IRC

Cabezal inoxidable



INOXIDABLE



CÓDIGO	MEDIDA	€/100		
ASFIRCA	Cabezal	106,197	50	1.000

AB-SF IRR

Rollo 30 m. Inoxidable



INOXIDABLE



CÓDIGO	MEDIDA	€/PC		
ASFIR30	9 x 0,6 mm/ 30 m	53,097	1	10

CI-PE

Cinta perforada

CI-PE

Cinta perforada curva. ATLANTIS C2-M



SANEAMIENTO



CÓDIGO	MEDIDA	€/PC	UD. MIN. VENTA		
CIPE1208	12 x 0,8 x 10 m	7,084	10	1	40
CIPE1708	17 x 0,8 x 10 m	9,245	10	1	30



CI-PE A2

Cinta perforada curva. Inoxidable A2



INOXIDABLE



CÓDIGO	MEDIDA	€/PC		
CIPEA21708	17 x 0,8 x 10 m	36,422	1	30



Cinta perforada

CI-PE

02 Info
p. 426 Técnica

SANEAMIENTO



CÓDIGO	MEDIDA	€/PC	UD. MIN. VENTA		
CIPR1908	19 x 0,8 x 10 m	10,706	5	1	30
CIPR1208	12 x 0,8 x 10 m	7,710	5	1	40

CI-PR

Cinta perforada recta ATLANTIS C2-M





Abrazadera cromada M6

AB-CR

02 Info
p. 426 Técnica

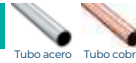
SANEAMIENTO



CÓDIGO	MEDIDA	ØD(mm)	€/100	MEDIDA EN PULGADAS	CARGA MÁXIMA		
ABCR010	10 (M6)	10	30,735	1/8"	70	100	1.200
ABCR012	12 (M6)	12	33,102	1/4"	70	100	1.200



EJEMPLOS DE APLICACIÓN





Abrazadera inoxidable Indextube

AB-IT

SANEAMIENTO



CÓDIGO	MEDIDA	€/100		
ABITS015	15	193,863	100	600
ABITS018	18	210,063	100	400
ABITS022	22	311,367	100	400
ABITS028	28	418,547	100	300



AB-ITS

Simple



SANEAMIENTO



CÓDIGO	MEDIDA	€/100		
ABITD015	15	716,737	50	300
ABITD018	18	811,463	50	200
ABITD022	22	1.016,350	50	100

AB-ITD

Doble



AB-BU

Abrazadera butano



02 Info. Técnica
P. 426

SANEAMIENTO



CÓDIGO	MEDIDA	ØD(mm)	€/100	MEDIDA EN PULGADAS		
ABBU1315	13 - 15	13-15	31,402	1/2" - 9/16"	50	600
ABBU1618	16 - 18	16-18	31,402	5/8" - 11/16"	50	600
ABBU1921	19 - 21	19-21	48,410	3/4" - 13/16"	50	600

EJEMPLOS DE APLICACIÓN



AB-GM

Abrazadera gásmica con tirafondo amarilla



02 Info. Técnica
P. 427

SANEAMIENTO



CÓDIGO	MEDIDA	ØD(mm)	€/100	MEDIDA EN PULGADAS	CARGA MÁXIMA		
ABGM012	12 (M6)	12	37,746	1/4"	70	100	600
ABGM015	15 (M6)	15	40,045	-	70	100	600
ABGM018	18 (M6)	18	40,714	3/8"	70	100	600
ABGM022	22 (M6)	22	43,443	1/2"	70	50	200
ABGM028	28 (M6)	28	45,875	3/4"	70	50	200
ABGM035	35 (M6)	35	56,973	-	70	50	200

De acuerdo a
UNE-EN ISO 4892

EJEMPLOS DE APLICACIÓN





Abrazadera gásmica negra M6 con tirafondo

AB-CS

02 Info. Técnica
P. 427

SANEAMIENTO





CÓDIGO	MEDIDA	ØD(mm)	€/100	MEDIDA EN PULGADAS	CARGA MÁXIMA		
ABGS010	10 (M6)	10	38,163	1/8"	70	100	600
ABGS012	12 (M6)	12	38,840	1/4"	70	100	600
ABGS015	15 (M6)	15	38,509	-	70	100	600
ABGS018	18 (M6)	18	39,579	3/8"	70	100	600
ABGS022	22 (M6)	22	42,957	1/2"	70	50	200
ABGS028	28 (M6)	28	45,823	3/4"	70	50	200
ABGS035	35 (M6)	35	54,777	-	70	50	200
ABGS042	42 (M6)	42	60,427	1 1/4"	70	25	100
ABGS054	54 (M6)	54	81,467	-	70	25	100



De acuerdo a
UNE-EN ISO 4892

 Bolsa autoservicio

CÓDIGO	MEDIDA	€/BOLSA	PCS 	BOLSAS 
LSABGS015	15 (M6)	6,583	10	6
LSABGS018	18 (M6)	5,439	8	6
LSABGS022	22 (M6)	4,944	6	6



Abrazadera gásmica negra doble M6 con tirafondo

AB-GD

02 Info. Técnica
P. 427

SANEAMIENTO



CÓDIGO	MEDIDA	ØD(mm)	€/100	MEDIDA EN PULGADAS	CARGA MÁXIMA		
ABGD012	12 (M6)	12	52,833	-	100	50	300
ABGD015	15 (M6)	15	57,043	-	100	50	300
ABGD018	18 (M6)	18	64,193	3/8"	100	50	300
ABGD022	22 (M6)	22	65,787	1/2"	100	50	200
ABGD028	28 (M6)	28	86,600	-	100	50	200



De acuerdo a
UNE-EN ISO 4892

EJEMPLOS DE APLICACIÓN





SISTEMAS DE PROTECCIÓN CONTRA INCENDIOS



AB-PE

Abrazadera colgante pera



 Info.
Técnica
P. 428

SANEAMIENTO



CÓDIGO	MEDIDA	ØD(mm)	€/100	MEDIDA EN PULGADAS	CARGA MÁXIMA		
ABPE028	28 (M10)	DN 20	88,829	3/4"	154	50	200
ABPE035	35 (M10)	DN 25	93,162	1"	186	50	200
ABPE040	40 (M10)	DN 32	109,618	1 1/4"	195	50	200
ABPE048	48 (M10)	DN 40	109,654	1 1/2"	236	50	200
ABPE060	60 (M10)	DN 50	124,214	2"	288	50	200
ABPE075	75 (M10)	DN 65	143,642	2 1/2"	426	25	100
ABPE090	90 (M10)	DN 80	161,763	3"	481	25	100
ABPE100	100 (M10)	DN 90	199,350	3 1/2"	569	25	100
ABPE115	115 (M10)	DN 100	269,683	4"	669	25	100
ABPE140	140 (M12)	DN 125	480,493	5"	907	10	40
ABPE160	160 (M12)	DN 150	561,402	6"	1186	10	40
ABPE220	220 (M12)	DN 200	982,458	8"	1723	10	40

EJEMPLOS DE APLICACIÓN



AB-CH

Abrazadera para tubería Clevis



 Info.
Técnica
P. 428

SANEAMIENTO



CÓDIGO	HOMOLOGACIÓN	MEDIDA	ØD(mm)	€/100	
ABCH00034	UL	3/4"	28	283,974	50
ABCH01000	UL	1"	35	299,709	50
ABCH01014	UL	1 1/4"	42	301,578	50
ABCH01012	UL	1 1/2"	48	325,616	50
ABCH02000	UL	2"	60	333,434	50
ABCH02012	UL & FM	2 1/2"	75	607,443	30
ABCH03000	UL & FM	3"	90	626,685	25
ABCH04000	UL & FM	4"	115	1.150,461	25
ABCH05000	UL & FM	5"	140	1.596,086	25
ABCH06000	UL & FM	6"	160	2.258,957	10
ABCH08000	UL & FM	8"	220	3.386,195	10
ABCH10000	UL	10"	275	5.775,395	1
ABCH12000	UL	12"	325	7.666,323	1
ABCH14000	-	14"	355	9.901,050	1
ABCH16000	-	16"	405	14.220,861	1

Collarín intumescente

AB-CI





CÓDIGO	MEDIDA	€/PC	
ABCIKIT25	2,5 m x 50 mm	498,854	1
ABCIKIT30	3 m x 50 mm	595,637	1



Anclaje metálico tipo cuña. Homologado ETE

AN-CU



CÓDIGO	MEDIDA	€/100	Ø BROCA		
ANCU06040	6 x 40 Ø6	29,149	6	100	1.200
ANCU06070	6 x 70 Ø6	43,747	6	100	1.200





SOPORTES PARA CANALONES



TE

Soportes de canalón

TE-MO

Módulo para canal de PVC



CÓDIGO	ØD(mm)	A(MM)	€/100	
TEM025	100	60	281,590	50
TEM033	150	80	347,060	50

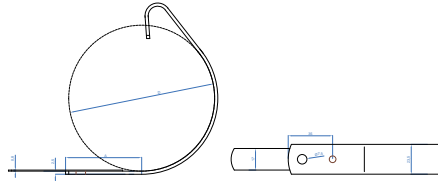

TE-GA

Gancho para canal de PVC



CÓDIGO	ØD(mm)	€/100	
TEGA25	100	424,513	50
TEGA33	150	443,517	50

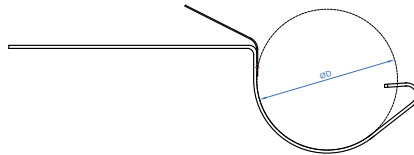

TE-GR

Placa teja grande



CÓDIGO	A(MM)	B(MM)	L(MM)	€/100	
TEGR2530	35	50	80	255,781	50

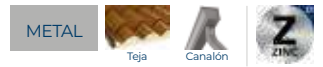
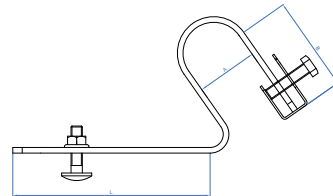

TE-PE

Placa teja



CÓDIGO	A(MM)	B(MM)	L(MM)	€/100	
TEPE2530	22	50	100	241,417	50

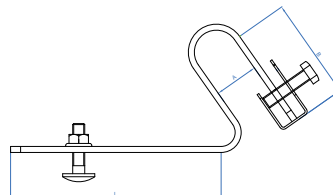

EJEMPLOS DE APLICACIÓN





ABRAZADERAS PLÁSTICAS



Las bridas de Nylon® y sus accesorios son uno de los productos de mayor demanda en el mundo de la instalación profesional. Están indicadas para todo tipo de aplicaciones, tales como instalaciones eléctricas, jardinería, cableado industrial, construcción, DIY, cadenas de fabricación o instalaciones fotovoltaicas. La gama de bridas de INDEX está compuesta de una amplia variedad de colores y tamaños, bridas detectables y accesorios varios. Contamos con la certificación UNE-EN 62275 (marcado CE) y con la homologación UL.



CUALIDADES Y VENTAJAS



INSTALACIÓN RÁPIDA Y SENCILLA

El diseño ergonómico de la cola flexible de la brida facilita un enhebrado fácil y suave.



ALTAS PRESTACIONES

El diseño del cabezal garantiza una alta resistencia a la tracción, garantizando un fuerte tensado. Hasta 122,3 Kg* de carga de rotura según EN 50146.

*En brida con anchura de 12 mm.



DENTADO INTERIOR

El diseño del dentado interior asegura un óptimo ajuste de la brida sin dañar el objeto a fijar.



MÁXIMA CALIDAD Y GARANTÍAS

La calidad de las bridas de INDEX está garantizada con los más altos estándares de calidad, gracias a la certificación de acuerdo con la norma UNE-EN 62275, que permite el marcado CE y con homologación UL.

APLICACIONES



- Cableados en general:
- Cableados eléctricos, sujeción de mangueras, agrupación de mangueras de cables
- Plantas Solares
- Automoción y Aeronáutica
- Embalaje de Productos
- Parques Infantiles
- Industria Farmacéutica y Alimentación
- Bricolaje y Jardinería
- Arte y Manualidades
- Instalaciones con requisitos HACCP/APPCC (bridas desechables)

GAMA



BRIDAS BLANCAS Y NEGRAS

Las bridas de Nylon® blancas y negras de dentado interior son muy versátiles, ya que sirven para numerosos usos en múltiples industrias. Están disponibles en una gran variedad de tamaños, permitiendo una óptima fijación del elemento a fijar, ya sean mazos de cables, tubos y/o mangueras.

Las bridas negras, fabricadas con poliamida y aditivo negro, disponen de una mayor resistencia a la radiación ultravioleta, siendo aptas para aplicaciones en exterior. Las bridas blancas (naturales) están indicadas para aplicaciones en interior.

Son idóneas para uso en instalaciones donde sea necesaria una alta resistencia a álcalis, aceites, grasas, derivados del aceite o disolventes clorados. Por el contrario, tienen una resistencia limitada a ácidos y no son resistentes a fenoles.



BRIDAS DE COLORES

Las bridas de colores están indicadas para el cableado en cajas de conexión en las que se agrupan distintos mazos de cables, permitiendo identificarlos de manera rápida y sencilla y posibilitando ordenar visualmente el espacio de trabajo. También se utilizan en aquellas aplicaciones donde se requiera que las bridas pasen desapercibidas (vallados).

Disponibles en una amplia gama de medidas en color **marrón, amarillo, azul, rojo, verde y gris**.



BRIDAS DETECTABLES

Las bridas detectables están especialmente diseñadas para la utilización en la industria alimentaria, cosmética, farmacéutica y en todas aquellas que sean aplicaciones donde se deben **cumplir los requisitos de la metodología HACCP* o APPCC** (Análisis de Peligros y Puntos Críticos de Control).

Fabricadas en Poliamida 6.6 con partículas metálicas, disponen de **propiedades magnéticas que permiten la detección** con un detector de metales, así como por equipos de inspección de rayos X. Además, su particular color azul facilita su detección visual.



PACKAGING Y PUNTO DE VENTA



La bolsa donde se venden las bridas dispone de toda la información necesaria de un solo vistazo.

En la etiqueta está impreso las dimensiones de la brida, la temperatura de uso, el tamaño mínimo y máximo de diámetro, la tensión soportada, código o EAN. Se trata de una bolsa de plástico de alta calidad que garantiza su estanqueidad para mantener el contenido de humedad recomendada.

Las bridas se presentan tres opciones de presentación en lineal:



BOLSAS COLGADAS EN GANCHOS



BOLSAS COLOCADAS EN BANDEJAS



BOLSAS EN CAJAS EXPOSITOARIAS

RECOMENDACIONES DE USO Y ALMACENAJE DE LAS BRIDAS

Las bridas de INDEX están fabricadas en poliamida de alta calidad, un material plástico higroscópico, es decir, que el material absorbe y pierde agua en función de las condiciones externas (humedad y temperatura). Para garantizar una correcta manipulación y una óptima conservación de la poliamida, las bolsas de bridas contienen el nivel de humedad adecuado.

Recomendamos seguir las siguientes indicaciones para un correcto comportamiento del producto:



No abrir la bolsa hasta el momento de usarlas y una vez abiertas utilizarlas lo antes posible o bien almacenarlas en bolsas de plástico herméticas.



No almacenar cerca de fuentes de calor.



Condiciones óptimas de almacenamiento: 23°C de temperatura y 50% de humedad relativa.



No exponer directamente al sol.



Bridas de nylon

BN

MULTIMATERIAL



BN-N

Negra

CÓDIGO	MEDIDA	€/100		
BN25080	2,5 x 80	1,216	100	60.000
BN25100	2,5 x 100	1,385	100	50.000
BN25140	2,5 x 140	2,163	100	50.000
BN25160	2,5 x 160	2,354	100	50.000
BN25200	2,5 x 200	2,907	100	35.000
BN36140	3,6 x 140	2,991	100	30.000
BN36200	3,6 x 200	4,074	100	25.000
BN36250	3,6 x 250	5,530	100	12.000
BN36300	3,6 x 300	6,354	100	12.000
BN36370	3,6 x 370	8,524	100	12.000
BN48120	4,8 x 120	4,410	100	23.000
BN48160	4,8 x 160	4,853	100	23.000
BN48180	4,8 x 180	5,232	100	16.000
BN48200	4,8 x 200	5,293	100	16.000
BN48250	4,8 x 250	7,644	100	12.000
BN48290	4,8 x 290	8,190	100	11.000
BN48370	4,8 x 370	10,674	100	8.000
BN48430	4,8 x 430	14,496	100	8.000
BN76150	7,6 x 150	11,284	100	12.000
BN76200	7,6 x 200	12,215	100	9.000
BN76290	7,6 x 290	15,704	100	5.000
BN76370	7,6 x 370	18,908	100	5.000
BN76450	7,6 x 450	29,127	100	3.000
BN76540	7,6 x 540	33,733	100	3.000
BN88770	8,8 x 770	64,513	50	1.000
BN12225	12,5 x 225	43,107	50	2.000
BN12500	12,5 x 500	88,134	50	1.000
BN12720	12,5 x 720	125,192	50	1.000
BN12850	12,5 x 850	144,772	50	1.000
BN12100	12,5 x 1000	177,756	50	1.000



PAHs

Blíster

CÓDIGO	MEDIDA	€/BOLSA	PCS	BOLSAS
BZBN25100	2,5 x 100	1,943	20	20
BZBN25160	2,5 x 160	1,943	20	20
BZBN25200	2,5 x 200	1,943	20	20
BZBN36140	3,6 x 140	1,943	20	20
BZBN36200	3,6 x 200	1,943	20	20
BZBN36300	3,6 x 300	2,459	20	15
BZBN48160	4,8 x 160	2,459	20	15
BZBN48200	4,8 x 200	2,459	20	15
BZBN48290	4,8 x 290	2,459	10	15
BZBN48370	4,8 x 370	2,459	10	15

Caja expositora

CÓDIGO	MEDIDA	€/BOLSA	PCS	BOLSAS
CKBN25080	2,5 x 80	1,277	100	30
CKBN25100	2,5 x 100	1,455	100	30
CKBN25140	2,5 x 140	2,271	100	30
CKBN25160	2,5 x 160	2,472	100	20
CKBN25200	2,5 x 200	3,053	100	20
CKBN36140	3,6 x 140	3,140	100	20
CKBN36200	3,6 x 200	4,277	100	20
CKBN36300	3,6 x 300	6,672	100	10
CKBN36370	3,6 x 370	8,950	100	10
CKBN48120	4,8 x 120	4,630	100	20
CKBN48160	4,8 x 160	5,096	100	20
CKBN48180	4,8 x 180	5,493	100	20
CKBN48200	4,8 x 200	5,558	100	20
CKBN48250	4,8 x 250	8,026	100	10
CKBN48290	4,8 x 290	8,600	100	10
CKBN48370	4,8 x 370	11,208	100	10
CKBN76200	7,6 x 200	12,826	100	10
CKBN76290	7,6 x 290	16,490	100	10
CKBN76370	7,6 x 370	19,854	100	8
CKBN12225	12,5 x 225	22,631	50	10



BN

Bridas de nylon

BN-B

Blanca

MULTIMATERIAL



CÓDIGO	MEDIDA	€/100		
BB25080	2,5 x 80	1,216	100	1.000
BB25100	2,5 x 100	1,385	100	1.000
BB25140	2,5 x 140	2,163	100	1.000
BB25160	2,5 x 160	2,354	100	1.000
BB25200	2,5 x 200	2,907	100	1.000
BB36140	3,6 x 140	2,991	100	1.000
BB36200	3,6 x 200	4,074	100	1.000
BB36250	3,6 x 250	5,530	100	1.000
BB36300	3,6 x 300	6,354	100	1.000
BB36370	3,6 x 370	8,524	100	1.000
BB48120	4,8 x 120	4,410	100	1.000
BB48160	4,8 x 160	4,853	100	1.000
BB48180	4,8 x 180	5,232	100	1.000
BB48200	4,8 x 200	5,293	100	1.000
BB48250	4,8 x 250	7,644	100	1.000
BB48290	4,8 x 290	8,190	100	1.000
BB48370	4,8 x 370	10,674	100	1.000
BB48430	4,8 x 430	14,496	100	1.000
BB76150	7,6 x 150	11,284	100	1.000
BB76200	7,6 x 200	12,215	100	1.000
BB76290	7,6 x 290	15,704	100	1.000
BB76370	7,6 x 370	18,908	100	1.000
BB76450	7,6 x 450	29,127	100	1.000
BB76540	7,6 x 540	33,733	100	1.000
BB88770	8,8 x 770	64,513	50	1.000
BB12225	12,5 x 225	43,107	50	500
BB12500	12,5 x 500	88,134	50	500
BB12720	12,5 x 720	125,192	50	500
BB12850	12,5 x 850	144,772	50	500
BB12100	12,5 x 1000	177,756	50	500

Blíster

CÓDIGO	MEDIDA	€/BOLSA	PCS BLS	BOLSAS
BZBB25100	2,5 x 100	1,943	20	20
BZBB25160	2,5 x 160	1,943	20	20
BZBB25200	2,5 x 200	1,943	20	20
BZBB36140	3,6 x 140	1,943	20	20
BZBB36200	3,6 x 200	1,943	20	20
BZBB36300	3,6 x 300	2,459	20	15
BZBB48160	4,8 x 160	2,459	20	15
BZBB48200	4,8 x 200	2,459	20	15
BZBB48290	4,8 x 290	2,459	10	15
BZBB48370	4,8 x 370	2,459	10	15

Caja expositora

CÓDIGO	MEDIDA	€/BOLSA	PCS	BOLSAS
CKBB25080	2,5 x 80	1,277	100	30
CKBB25100	2,5 x 100	1,455	100	30
CKBB25140	2,5 x 140	2,271	100	30
CKBB25160	2,5 x 160	2,472	100	20
CKBB25200	2,5 x 200	3,053	100	20
CKBB36140	3,6 x 140	3,140	100	20
CKBB36200	3,6 x 200	4,277	100	20
CKBB36300	3,6 x 300	6,672	100	10
CKBB36370	3,6 x 370	8,950	100	10
CKBB48120	4,8 x 120	4,630	100	20
CKBB48160	4,8 x 160	5,096	100	20
CKBB48180	4,8 x 180	5,493	100	20
CKBB48200	4,8 x 200	5,558	100	20
CKBB48250	4,8 x 250	8,026	100	20
CKBB48290	4,8 x 290	8,600	100	10
CKBB48370	4,8 x 370	11,208	100	10
CKBB76200	7,6 x 200	12,826	100	10
CKBB76290	7,6 x 290	16,490	100	10
CKBB76370	7,6 x 370	19,854	100	8
CKBB12225	12,5 x 225	22,631	50	8

Bridas de nylon colores

BN-CO

MULTIMATERIAL



CÓDIGO	MEDIDA	€/100		
BC25100GR	2,5 x 100	1,513	100	50.000
BC36140GR	3,6 x 140	3,637	100	30.000
BC36200GR	3,6 x 200	4,920	100	25.000
BC48200GR	4,8 x 200	6,400	100	16.000
BC48290GR	4,8 x 290	10,063	100	11.000

BN-GR

Gris



MULTIMATERIAL



CÓDIGO	MEDIDA	€/100		
BC25100VE	2,5 x 100	1,513	100	50.000
BC36140VE	3,6 x 140	3,637	100	30.000
BC36200VE	3,6 x 200	4,920	100	25.000
BC48200VE	4,8 x 200	6,400	100	16.000
BC48290VE	4,8 x 290	10,063	100	11.000

BN-VE

Verde



Caja expositora

CÓDIGO	MEDIDA	€/BOLSA	PCS 	BOLSAS 
CKBC25100VE	2,5 x 100	1,588	100	30
CKBC36140VE	3,6 x 140	3,823	100	20
CKBC36200VE	3,6 x 200	5,162	100	20
CKBC48200VE	4,8 x 200	6,722	100	20
CKBC48290VE	4,8 x 290	10,567	100	10

MULTIMATERIAL



CÓDIGO	MEDIDA	€/100		
BC25100MA	2,5 x 100	1,513	100	50.000
BC36140MA	3,6 x 140	3,637	100	30.000
BC36200MA	3,6 x 200	4,920	100	25.000
BC48200MA	4,8 x 200	6,400	100	16.000
BC48290MA	4,8 x 290	10,063	100	11.000

BN-MA

Marrón



Caja expositora

CÓDIGO	MEDIDA	€/BOLSA	PCS 	BOLSAS 
CKBC25100MA	2,5 x 100	1,588	100	30
CKBC36140MA	3,6 x 140	3,823	100	20
CKBC36200MA	3,6 x 200	5,162	100	20
CKBC48200MA	4,8 x 200	6,722	100	18
CKBC48290MA	4,8 x 290	10,567	100	10

MULTIMATERIAL



CÓDIGO	MEDIDA	€/100		
BC25100AM	2,5 x 100	1,513	100	50.000
BC36140AM	3,6 x 140	3,637	100	30.000
BC36200AM	3,6 x 200	4,920	100	25.000
BC48200AM	4,8 x 200	6,400	100	16.000
BC48290AM	4,8 x 290	10,063	100	11.000

BN-AM

Amarilla



BN-CO

Bridas de nylon colores

BN-AZ

Azul



MULTIMATERIAL



CÓDIGO	MEDIDA	€/100		
BC25100AZ	2,5 x 100	1,513	100	50.000
BC36140AZ	3,6 x 140	3,637	100	30.000
BC36200AZ	3,6 x 200	4,920	100	25.000
BC48200AZ	4,8 x 200	6,400	100	16.000
BC48290AZ	4,8 x 290	10,063	100	11.000

Caja expositora

CÓDIGO	MEDIDA	€/BOLSA	PCS	BOLSAS
CKBC25100AZ	2,5 x 100	1,588	100	30
CKBC36140AZ	3,6 x 140	3,823	100	20
CKBC36200AZ	3,6 x 200	5,162	100	20
CKBC48200AZ	4,8 x 200	6,722	100	18
CKBC48290AZ	4,8 x 290	10,567	100	10

BN-RO

Rojo



MULTIMATERIAL



CÓDIGO	MEDIDA	€/100		
BC25100RO	2,5 x 100	1,513	100	50.000
BC36140RO	3,6 x 140	3,637	100	30.000
BC36200RO	3,6 x 200	4,920	100	25.000
BC48200RO	4,8 x 200	6,400	100	16.000
BC48290RO	4,8 x 290	10,063	100	11.000

Caja expositora

CÓDIGO	MEDIDA	€/BOLSA	PCS	BOLSAS
CKBC25100RO	2,5 x 100	1,588	100	30
CKBC36140RO	3,6 x 140	3,823	100	20
CKBC36200RO	3,6 x 200	5,162	100	20
CKBC48200RO	4,8 x 200	6,722	100	18
CKBC48290RO	4,8 x 290	10,567	100	10

BN-DT

Brida detectable



MULTIMATERIAL



CÓDIGO	MEDIDA	€/100		
BNDT25100	2,5 x 100	3,404	100	50.000
BNDT36150	3,6 x 150	7,802	100	30.000
BNDT36200	3,6 x 200	10,450	100	25.000
BNDT48200	4,8 x 200	12,770	100	16.000
BNDT48300	4,8 x 300	19,733	100	11.000
BNDT48370	4,8 x 370	27,860	100	8.000
BNDT76370	7,6 x 370	51,080	100	5.000

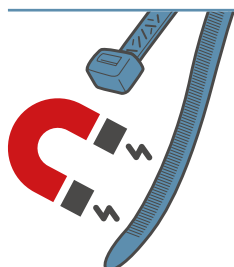

BRIDA DETECTABLE con partículas metálicas

- TRIPLE DETECCIÓN:



MAGNÉTICA



RAYOS X



VISUAL

- COMPATIBLE COMO PARTE DEL PROCESO HACCP*/APPCC**.

*HACCP: Hazard Analysis and Critical Control Points). Sistema de inocuidad alimentaria basado en la identificación de todos los peligros potenciales en los ingredientes y los distintos procesos de producción de los alimentos.

** APPCC: Análisis de Peligros y Puntos Críticos de Control.



Taco para bridas

TACOBRI

MULTIMATERIAL



CÓDIGO	MEDIDA	COLOR	€/100		
TACOBRI6	Ø6	NEGRO	6,993	100	5.000
TACOBRI8	Ø8	NEGRO	6,130	100	5.000

Blíster

CÓDIGO	MEDIDA	€/BOLSA	PCS	BOLSAS
BZTABRI6	Ø6	1,943	4	15
BZTABRI8	Ø8	1,943	4	15

Caja expositora

CÓDIGO	MEDIDA	€/BOLSA	PCS	BOLSAS
CKTACOBRI6	Ø6	7,410	100	10
CKTACOBRI8	Ø8	6,563	100	10

TACOBRI N

Negro



MULTIMATERIAL



CÓDIGO	MEDIDA	COLOR	€/100		
TACOBRI6	Ø6	BLANCO	7,213	100	5.000
TACOBRI8	Ø8	BLANCO	6,620	100	5.000

Blíster

CÓDIGO	MEDIDA	€/BOLSA	PCS	BOLSAS
BZTABRI6	Ø6	1,943	4	15
BZTABRI8	Ø8	1,943	4	15

Caja expositora

CÓDIGO	MEDIDA	€/BOLSA	PCS	BOLSAS
CKTACOBRI6	Ø6	7,577	100	10
CKTACOBRI8	Ø8	6,950	100	10

TACOBRI B

Blanco



MULTIMATERIAL



CÓDIGO	MEDIDA	COLOR	€/100		
TACOBRI8	Ø8	GRIS	8,043	100	5.000

TACOBRI G

Gris



Bridas de nylon con identificación

BN-ID

MULTIMATERIAL



CÓDIGO	MEDIDA	€/100		
BID25110	2,5 x 110	8,573	100	16.000
BID25210	2,5 x 210	18,860	100	12.000



Placa de identificación de nylon de hasta 4,8 mm

BN-PL

MULTIMATERIAL



CÓDIGO	MEDIDA	€/100		
BPL02616	26,4 x 16,2	23,070	100	5.000



BN-BA

Base de dos vías adhesivas para bridas de nylon



MULTIMATERIAL



CÓDIGO	MEDIDA	COLOR	€/100		
BBANA19	19 x 19	BLANCO	18,483	100	15.000
BBANA27	27 x 27	BLANCO	26,440	100	6.000
BBANE19	19 x 19	NEGRO	18,483	100	15.000
BBANE27	27 x 27	NEGRO	26,440	100	6.000

AB-IN

Clip simple de polipropileno con casquillo de latón M6



Info. Técnica

SANEAMIENTO

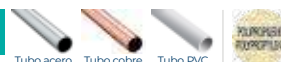

CÓDIGO	MEDIDA	ØD(mm)	€/100		
ABINO12	12	12	30,838	100	1.200
ABINO14	14-15	14-15	33,001	100	600
ABINO16	16-18	16-18	42,203	100	600
ABINO20	20-22	20-22	44,199	100	400
ABINO25	25	25	57,200	50	300
ABINO28	28	28	57,190	50	300
ABINO32	32	32	76,666	25	150
ABINO35	35	35	85,146	25	300

Bolsa autoservicio

CÓDIGO	MEDIDA	€/BOLSA	PCS	BOLSAS
LSABINO12	12	5,498	10	6
LSABINO14	14-15	5,757	10	5
LSABINO16	16-18	5,349	8	6
LSABINO20	20-22	4,643	6	5
LSABINO28	28	4,234	4	6

INSTALACIÓN

PERFIL



AB-ID

Clip doble de polipropileno con casquillo de latón M6



Info. Técnica

SANEAMIENTO

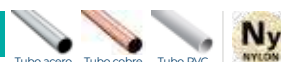

CÓDIGO	MEDIDA	ØD(mm)	€/100		
ABIDO12	12	12	66,623	50	200
ABIDO14	14-15	14-15	69,937	50	300
ABIDO16	16-18	16-18	89,240	50	200
ABIDO20	20-22	20-22	94,533	50	150
ABIDO28	28	28	116,717	25	100

Bolsa autoservicio

CÓDIGO	MEDIDA	€/BOLSA	PCS	BOLSAS
LSABIDO12	12	5,963	6	6
LSABIDO14	14-15	6,207	6	5
LSABIDO16	16-18	3,627	2	6
LSABIDO20	20-22	3,730	2	6
LSABIDO28	28	4,177	2	6

INSTALACIÓN

PERFIL



EJEMPLOS DE APLICACIÓN



Abrazadera guía simple con pre-rosca M6

AB-GU

02
P. 429

Info
Técnica

SANEAMIENTO



CÓDIGO	MEDIDA	ØD(mm)	€/100		
ABGUG15	15	15	24,737	100	400
ABGUG18	18	18	24,987	100	400
ABGUG20	20	20	26,300	100	400
ABGUG22	22	22	27,857	100	300
ABGUG25	25	25	30,950	50	300
ABGUG28	28	28	38,713	50	200
ABGUG32	32	32	42,153	25	150
ABGUG40	40	40	56,067	25	150
ABGUG50	50	50	67,237	25	100



Bolsa autoservicio

CÓDIGO	MEDIDA	€/BOLSA	PCS	BOLSAS
LSABGUG15	15	3,646	8	6
LSABGUG18	18	3,344	6	6
LSABGUG20	20	2,867	4	7
LSABGUG22	22	2,997	4	7
LSABGUG25	25	2,647	2	6
LSABGUG28	28	2,692	2	6
LSABGUG32	32	2,822	2	6
LSABGUG40	40	3,039	2	6
LSABGUG50	50	3,258	2	6

INSTALACIÓN

PERFIL



PISTOLA



TACO + TORNILLO



CAÑÓN ELECTRICISTA

Abrazadera multidímetro

AB-MUG

02
P. 430

Info
Técnica

SANEAMIENTO



CÓDIGO	MEDIDA	ØD(mm)	€/100		
ABMUG15	15-16	15	21,977	100	400
ABMUG18	18-20	18	27,703	100	400
ABMUG22	22-25	22	32,910	100	300
ABMUG26	26-28	26	41,103	50	150
ABMUG32	32-35	32	53,047	50	150
ABMUG40	40-42	40	71,767	50	100
ABMUG48	48-50	42	86,263	25	75



Bolsa autoservicio

CÓDIGO	MEDIDA	€/BOLSA	PCS	BOLSAS
LSABMUG15	15-16	3,557	8	6
LSABMUG18	18-20	3,457	6	6
LSABMUG22	22-25	3,077	4	7
LSABMUG26	26-28	2,633	2	6
LSABMUG32	32-35	2,887	2	6

INSTALACIÓN

PERFIL



PISTOLA



TACO + TORNILLO



CAÑÓN ELECTRICISTA

AB-PR

Abrazadera a presión con pre-rosca M6



SANEAMIENTO



CÓDIGO	MEDIDA	ØD(mm)	€/100		
ABPRG15	15-18	15-18	25,473	100	400
ABPRG20	20-22	20-22	27,057	100	400
ABPRG25	25-28	25-28	32,133	100	300
ABPRG32	32-35	32-35	44,857	25	150
ABPRG40	40	40	57,893	25	150
ABPRG50	50	50	72,970	25	100

Bolsa autoservicio

CÓDIGO	MEDIDA	€/BOLSA	PCS	BOLSAS
LSABPRG15	15-18	3,903	8	6
LSABPRG20	20-22	3,103	4	5
LSABPRG25	25-28	2,907	3	6

INSTALACIÓN



AB-MS

Abrazadera multitubo + taco. Simple



Info. Técnica
P. 430

SANEAMIENTO



CÓDIGO	MEDIDA	ØD(mm)	€/100	CARGA MÁXIMA		
ABMS10	5 x 20 Ø5	10	29,840	9	100	1.200
ABMS12	5 x 20 Ø5	12	31,807	9	100	1.200
ABMS14	6 x 25 Ø6	14	44,337	15	100	600
ABMS16	6 x 25 Ø6	16	45,760	15	100	600
ABMS18	8 x 30 Ø8	18	60,177	16	100	300
ABMS20	8 x 30 Ø8	20	61,607	16	50	300
ABMS22	8 x 30 Ø8	22	62,973	16	50	300
ABMS26	10 x 40 Ø10	26	118,527	30	50	150
ABMS28	10 x 40 Ø10	28	120,423	30	50	150

AB-MD

Abrazadera multitubo + taco. Doble



Info. Técnica
P. 431

SANEAMIENTO



CÓDIGO	MEDIDA	ØD(mm)	€/100	CARGA MÁXIMA		
ABMD10	8 x 30 Ø8	10	59,007	16	100	300
ABMD12	8 x 30 Ø8	12	60,207	16	100	300
ABMD14	8 x 30 Ø8	14	61,410	16	100	300
ABMD16	8 x 30 Ø8	16	60,443	16	100	300
ABMD18	10 x 40 Ø10	18	85,397	30	100	200
ABMD20	10 x 40 Ø10	20	90,643	30	50	150
ABMD22	10 x 40 Ø10	22	93,360	30	50	150
ABMD26	10 x 40 Ø10	26	149,040	30	50	100
ABMD28	10 x 40 Ø10	28	150,180	30	50	100

Taco para fijación de tubo INDEXring

AB-T

02
P. 431
Info
Técnica

SANEAMIENTO



CÓDIGO	MEDIDA	ØD(mm)	€/100	MEDIDA EN PULGADAS		
ABTS014	14	14 - 15	35,277	-	100	600
ABTS016	16	16 - 17	36,547	3/8"	100	400
ABTS018	18	18 - 19	39,493	-	100	400
ABTS020	20	20 - 21	40,153	1/2"	100	300
ABTS022	22	22 - 23	41,180	-	100	300
ABTS025	25	25 - 26	42,517	3/4"	100	300
ABTS028	28	28 - 29	50,473	-	100	200
ABTS032	30	30 - 32	65,057	-	50	150

Bolsa autoservicio

CÓDIGO	MEDIDA	€/BOLSA	PCS	BOLSAS
LSABTS018	18	4,396	6	6
LSABTS022	22	4,685	6	6

AB-TS

Simple



02
P. 431
Info
Técnica

SANEAMIENTO



CÓDIGO	MEDIDA	ØD(mm)	€/100	MEDIDA EN PULGADAS		
ABTD016	16	15 - 16	43,017	3/8"	100	400
ABTD018	18	18 - 19	48,913	-	100	300
ABTD020	20	20 - 21	50,080	1/2"	100	200
ABTD022	22	22 - 23	53,927	-	100	200
ABTD025	25	25 - 26	58,720	3/4"	100	200
ABTD028	28	28 - 29	78,257	-	50	150

Bolsa autoservicio

CÓDIGO	MEDIDA	€/BOLSA	PCS	BOLSAS
LSABTD018	18	4,100	4	6
LSABTD022	22	3,072	2	7

AB-TD

Doble



02
P. 432
Info
Técnica

SANEAMIENTO



CÓDIGO	MEDIDA	ØD(mm)	€/100	MEDIDA EN PULGADAS		
ABTC020	20	20 - 21	83,320	1/2"	50	100
ABTC025	25	25 - 26	102,450	3/4"	50	100

AB-TC

Cuádruple



EJEMPLOS DE APLICACIÓN



FI-CA

Fijaciones para cables

FI-CA AB

Abrazadera



MULTIMATERIAL



CÓDIGO	MEDIDA	€/100		
FICAAB080	80	155,200	50	
FICAAB119	119	258,667	25	

FI-CA PS

Pinza simple



MULTIMATERIAL



CÓDIGO	MEDIDA	€/100		
FICAPS080	80	74,367	50	1.500

FI-CA PD

Pinza doble



MULTIMATERIAL



CÓDIGO	MEDIDA	€/100		
FICAPD160	80 (x2)	109,933	50	800

FI-CA CL

Clip



MULTIMATERIAL



CÓDIGO	MEDIDA	€/100	TALADRO		
FICACL13	Ø13	15,843	6	200	2.400
FICACL26	Ø16	21,017	6	100	1.200



Fijaciones para cables

FI-CA

SANEAMIENTO



CÓDIGO	MEDIDA	VÁLIDO PARA	€/100	UD. MIN. VENTA	
GRBL010	2 x 0,7 - 2 x 1	Cable Plano 6 x 3	8,117	400	100
GRBL100	2 x 4	Cable redondo Ø10	11,570	200	100
GRBL120	3 x 6	Cable redondo Ø12	14,207	200	100
GRBL001	2 x 0,7	Cable Paralelo	6,390	400	100
GRBL002	2 x 0,4 - 0,7 ó 1	Cable Paralelo	6,740	400	100
GRBL020	2 x 1,5 - 3 x 1	Cable Plano 7,5 x 3,5	8,243	400	100
GRBL003	2 x 1 - 3 x 0,7	Cable Plano 6 x 2	6,820	400	100
GRBL030	3 x 1,5 - 3 x 2,5	Cable Plano 10 x 3,5	9,973	400	100
GRBL040	1 x 1 - 2 x 0,5	Cable Redondo Ø4	7,860	400	100
GRBL050	2 x 0,75	Cable Redondo Ø5	8,073	400	100
GRBL060	2 x 1	Cable Redondo Ø6	8,550	400	100
GRBL070	2 x 1-1,5	Cable Redondo Ø7	9,327	400	100
GRBL080	2 x 2,5	Cable Redondo Ø8	9,410	400	100
GRBL090	3 x 2,5	Cable Redondo Ø9	10,363	400	100
GRBL140	4 x 6	Cable Redondo Ø14	16,877	200	100



Blíster

CÓDIGO	MEDIDA	€/BOLSA	PCS	BOLSAS
BZGRB100	2 x 4	2,459	6	20
BZGRB010	2 x 0,7 - 2 x 1	2,459	6	20
BZGRB120	3 x 6	2,459	6	15
BZGRB001	2 x 0,7	2,459	6	20
BZGRB050	2 x 0,75	2,459	6	20
BZGRB060	2 x 1	2,459	6	20
BZGRB070	2 x 1-1,5	2,459	6	20
BZGRB080	2 x 2,5	2,459	6	20
BZGRB090	3 x 2,5	2,459	6	20

SANEAMIENTO



CÓDIGO	MEDIDA	VÁLIDO PARA	€/100	UD. MIN. VENTA	
GRNE060	2 x 1	Cable Redondo	8,550	400	100
GRNE070	2 x 1 - 2 x 1,5	Cable Redondo	9,327	400	100
GRNE080	2 x 2,50	Cable Redondo	9,410	400	100
GRNE090	3 x 2,50	Cable Redondo	10,363	400	100
GRNE100	2 x 4	Cable Redondo	11,570	200	100
GRNE120	3 x 6	Cable Redondo	14,207	200	100

SANEAMIENTO



CÓDIGO	MEDIDA	VÁLIDO PARA	€/100	UD. MIN. VENTA		
GRNATTV	GRAPILLA - CLIP - CRAMPON TV - CLIP	Cable Redondo	11,160	200	100	2.000

GR-NY BL

Grapilla de nylon con clavo de acero zincado. Blanca



GR-NY N

Grapilla de nylon con clavo de acero zincado. Negra



GR-NY NT

Grapilla de nylon con clavo de acero cincado. Natural





PERFILERÍA Y SOPORTACIÓN



TABLA DE COMPATIBILIDAD

Código	Medida (mm)	Longitud (mm)	SOPORTES														ESCUADRAS Y CONEXIONES																					
			Vertical M10	Vertical M10	Horizontal M10	Horizontal M10	Horizontal	Horizontal	Horizontal	Horizontal	Vertical	0°	45°			EMZ45	EMZ90	EMZ00	EMI45	EMI90	EMI00	EMX4502	EMX9002	EMX1302	EMX9004	UNEX412103	UNTX412104	SCRX090	UNPX412101	UNPX412102	UNPX412103	UNPX412104	EMPX4121					
			Vertical M10	Vertical M10	Horizontal M10	Horizontal M10	Horizontal	Horizontal	Horizontal	Horizontal	Vertical	0°	45°			45°	90°	Plana	45° Inoxidable	90° Inoxidable	Plana inoxidable	45°	90°	130°	90°	Unión en L 3 agujeros	Unión en T 4 agujeros	90°	1 agujero	2 agujeros	3 agujeros	4 agujeros	Unión de 2 guías					
GPZ201010	20 x 10 x 1	2.000																																				
GPZ250808	25 x 8 x 0,8	1.000																																				
GPG271812	27 x 18 x 1,25	2.000	•		•		•							•	•	•																						
GPG283018	28 x 30 x 1,8	2.000	•		•		•							•	•	•																						
GPG351312	35 x 13 x 1,2	2.000																																				
GPG384020	38 x 40 x 2	2.000		•		•			•					•	•	•																						
GPG402015	40 x 20 x 1,5	2.000		•		•			•					•	•	•																						
GPI271812	27 x 18 x 1,25	2.000															•	•	•																			
GPI283015	28 x 30 x 1,8	2.000															•	•	•																			
GPP271812	27 x 18 x 1,25	1.000	•		•																																	
GPV251120	25 x 11 x 2	1.000																																				
GLO357510	35 x 7,5 x 1	2.000																																				
GLO351515	35 x 15 x 1,5	2.000																																				
GPO357510	35 x 7,5 x 1	2.000																																				
GPO351515	35 x 15 x 1,5	2.000																																				
GPX412115	41 x 21 x 1,5	3.000								•	•	•	•	•	•	•					•	•	•	•	•	•	•	•	•	•	•	•	•	•	•	•	•	
GPX412120	41 x 21 x 2,00	3.000								•	•	•	•	•	•	•					•	•	•	•	•	•	•	•	•	•	•	•	•	•	•	•	•	
GPX412125	41 x 21 x 2,5	3.000								•	•	•	•	•	•	•					•	•	•	•	•	•	•	•	•	•	•	•	•	•	•	•	•	
GPX414115	41 x 41 x 1,50	3.000								•	•	•	•	•	•	•					•	•	•	•	•	•	•	•	•	•	•	•	•	•	•	•	•	
GPX414120	41 x 41 x 2,00	3.000								•	•	•	•	•	•	•					•	•	•	•	•	•	•	•	•	•	•	•	•	•	•	•	•	
GPX414125	41 x 41 x 2,5	3.000								•	•	•	•	•	•	•					•	•	•	•	•	•	•	•	•	•	•	•	•	•	•	•	•	
SPZ271820	27 x 18 x 1,25	200																																				
SPZ271830	27 x 18 x 1,25	300																																				
SPZ384020	38 x 40 x 2	200																																				
SPZ384025	38 x 40 x 2	250																																				
SPZ384030	38 x 40 x 2	300																																				
SPZ384035	38 x 40 x 2	350																																				
SPZ384040	38 x 40 x 2	400																																				
SPZ384050	38 x 40 x 2	500																																				
SPZ384060	38 x 40 x 2	600																																				
SPX412115	41 x 21 x 2,5	150																																				
SPX412130	41 x 21 x 2,5	300																																				
SPX412145	41 x 21 x 2,5	450																																				
SPX414115	41 x 41 x 2,5	150																																				
SPX414130	41 x 41 x 2,5	300																																				
SPX414145	41 x 41 x 2,5	450																																				
SPX414160	41 x 41 x 2,5	600																																				
SPX414175	41 x 41 x 2,5	750																																				
SPX414110	41 x 41 x 2,5	1.000																																				



PUENTES GUÍA		TORNILLOS GUÍA		TUERCAS GUÍA		TAPONES	
GZZ2718							
PGZ2830							
PGZ3840							
PGI2718							
PGI2830							
PGI3840							
PGX4121							
PGX4141							
TC230620	M6 x 20						
TC230820	M8 x 20						
TC230830	M8 x 30						
TC340830	M8 x 30						
TC341030	M10 x 30						
TCR230620	M6 x 20						
TCR230820	M8 x 20						
TCR230830	M8 x 30						
TCR340830	M8 x 30						
TCR341030	M10 x 30						
TCRX0830	M8 x 30						
TCRX0860	M8 x 60						
TCRX1030	M10 x 30						
TCRX1060	M10 x 60						
TUG201006	M6						
TUG201008	M8						
TUG271808	M8						
TUG271810	M10						
TUGRA2706	M6						
TUGRA2708	M8						
TUGRA3808	M8						
TUGRA3810	M10						
TUGX08	M8						
TUGX10	M10						
TUCXMU08	Muelle						
TUCXMU10	Muelle						
TURX08							
TURX10							
TURX12							
TURXA08							
TURXA10							
SOTP2718							
SOTP2830							
SOTP3840							
SOTP4121							
SOTP4141							

GP

Perfiles para cargas ligeras tipo "C"

GP-Z

Guía perforada cincada



METAL



CÓDIGO	MEDIDA	€/100	LONGITUD	
GPZ201010	20 x 10 x 1 x 2000	715,913	2.000	30
GPZ250808	25 x 8 x 0,80 x 1000	590,804	1.000	30

GP-G

Guía perforada ATLANTIS C2-H



METAL



CÓDIGO	MEDIDA	€/100	LONGITUD	
GPG271812	27 x 18 x 1,25 x 2000	1.293,857	2.000	10
GPG283018	28 x 30 x 1,8 x 2000	2.658,370	2.000	10
GPG351312	35 x 13 x 1,2 x 2000	1.772,080	2.000	10
GPG384020	38 x 40 x 2 x 2000	4.391,170	2.000	6
GPG402015	40 x 20 x 1,50 x 2000	1.916,430	2.000	10

GP-A2

Guía perforada inoxidable A2



INOXIDABLE



CÓDIGO	MEDIDA	€/100	LONGITUD	
GPI271812	27 x 18 x 1,25 x 2000	11.696,187	2.000	6
GPI283015	28 x 30 x 1,50 x 2000	18.898,134	2.000	6
GPI384020	38 x 40 x 2,00 x 2000	39.110,865	-	5

GP-PL

Guía perforada plastificada amarilla



METAL



CÓDIGO	MEDIDA	€/100	LONGITUD	
GPP271812	27 x 18 x 1,25	1.862,700	1.000	10

GP-PVC

Guía perforada PVC



METAL



CÓDIGO	MEDIDA	€/100	LONGITUD	
GPV251120	25 x 11 x 2 x 1000	843,660	1.000	30

Perfiles para cargas ligeras tipo "C"

GP

METAL



CÓDIGO	MEDIDA	€/100	
GLO357510	35x7,5x1,0	777,323	10
GLO351515	35x15x1,5	1.321,680	10

GL-O

Guía Omega lisa ATLANTIS C2-M



METAL

CÓDIGO	MEDIDA	€/100	
GPO357510	35x7,5x1,0	736,710	10
GPO351515	35x15x1,5	1.317,593	10

GP-O

Guía Omega perforada ATLANTIS C2-M



Soportes para cargas ligeras tipo "C"

SP

METAL



CÓDIGO	MEDIDA	€/100	
SPZ271820	27 x 18 x 1,25 x 200	735,317	10
SPZ271830	27 x 18 x 1,25 x 300	793,490	10
SPZ384020	38 x 40 x 2 x 200	1.190,373	10
SPZ384025	38 x 40 x 2 x 250	1.322,804	10
SPZ384030	38 x 40 x 2 x 300	1.484,187	10
SPZ384035	38 x 40 x 2 x 350	1.590,140	10
SPZ384040	38 x 40 x 2 x 400	1.853,350	10
SPZ384050	38 x 40 x 2 x 500	2.250,770	10
SPZ384060	38 x 40 x 2 x 600	2.506,433	10

SP-Z

Soporte perforado cincado



METAL



CÓDIGO	MEDIDA	VÁLIDO PARA	€/100	
SPV2718	M10 (27/18-28/30)	27/18 - 28/30	518,800	50
SPV3840	M10 (38/40-40/20)	38/40 - 40/20	559,983	50

SP-V

Soporte vertical



SP

Soportes para cargas ligeras tipo "C"

SP-H

Soporte horizontal



METAL



CÓDIGO	MEDIDA	VÁLIDO PARA	€/100	
SPH2718	M10 (27/18-28/30)	27/18 - 28/30	470,463	50
SPH3840	M10 (38/40-40/20)	38/40 - 40/20	487,950	50

SP-HX

Soporte horizontal carriles



METAL



CÓDIGO	MEDIDA	VÁLIDO PARA	€/100	
SPGH2718	M10 (27/18-28/30)	27/18 - 28/30	723,884	10
SPGH3840	M10 (38/40-40/20-41/21-41/41)	38/40 - 40/20 - 41/21 - 41/41	1.406,908	10

PE-AC

Accesorios para perfiles tipo "C"

TO-GU

Tope tornillo guía



METAL



CÓDIGO	MEDIDA	VÁLIDO PARA	€/100		
TG230620	M6 x 20	20/10 - 27/18 - 28/30 - 25/08 - 25/11	67,094	100	800
TG230820	M8 x 20	27/18 - 28/30 - 25/08	80,959	100	400
TG230830	M8 x 30	27/18 - 28/30 - 25/08	85,212	100	600
TG340830	M8 x 30	38/40 - 40/20	123,427	100	600
TG341030	M10 x 30	38/40 - 40/21	159,827	100	400

TO-GR

Tope tornillo guía de fijación rápida



METAL



CÓDIGO	MEDIDA	VÁLIDO PARA	€/100		
TGR230620	M6x20	20/10 - 25/08 - 25/11 - 27/18 - 28/30	180,038	100	600
TGR230820	M8x20	20/10 - 25/08 - 25/11 - 27/18 - 28/30	190,304	100	600
TGR230830	M8x30	20/10 - 25/08 - 25/11 - 27/18 - 28/30	194,836	100	600
TGR340830	M8x30	27/18 - 28/30 - 38/40 - 40/20	244,717	100	400
TGR341030	M10x30	27/18 - 28/30 - 38/40 - 40/20	276,320	50	300

TU-GU

Tuerca guía perforada



METAL





CÓDIGO	MEDIDA	VÁLIDO PARA	€/100		
TUG201006	M6	20/10 - 25/08 - 27/18 - 28/30	17,731	100	3.000
TUG201008	M8	20/10 - 25/08 - 27/18 - 28/30	17,731	100	2.400
TUG271808	M8	27/18 - 28/30 - 38/40 - 40/20	47,747	100	1.200
TUG271810	M10	27/18 - 28/30 - 38/40 - 40/20	47,747	100	1.200

Accesorios para perfiles tipo "C"

PE-AC

METAL



CÓDIGO	MEDIDA	VÁLIDO PARA	€/100		
TUGRA2706	M6	20/10 - 25/08 - 25/11 - 27/18 - 28/30	163,069	50	600
TUGRA2708	M8	20/10 - 25/08 - 25/11 - 27/18 - 28/30	163,069	50	600
TUGRA3808	M8	27/18 - 28/30 - 38/40 - 40/20	209,126	50	600
TUGRA3810	M10	27/18 - 28/30 - 38/40 - 40/20	222,624	50	600

TU-GRA

Tuerca guía con arandela de fijación rápida



METAL



CÓDIGO	MEDIDA	VÁLIDO PARA	€/100		
EMZ45	50 x 50 45°	25/11 - 27/18 - 28/30 - 38/40 - 40/20 - 41/21 - 41/41	124,707	100	400
EMZ90	54 x 54 90°	25/11 - 27/18 - 28/30 - 38/40 - 40/20 - 41/21 - 41/41	124,707	100	300
EMZ00	100 180°	25/11 - 27/18 - 28/30 - 38/40 - 40/20 - 41/21 - 41/41	121,590	100	-

EG-Z

Escuadra cincada



INOXIDABLE



CÓDIGO	MEDIDA	VÁLIDO PARA	€/100		
EMI45	50 x 50 45°	27/18 - 28/30 - 38/40	634,667	50	200
EMI90	54 x 54 90°	27/18 - 28/30 - 38/40	634,667	50	-
EMI00	100 180°	27/18 - 28/30 - 38/40	629,223	50	200

EG-A2

Escuadra inoxidable A2



METAL



CÓDIGO	MEDIDA	VÁLIDO PARA	€/100	
PUZ2718	M8 (27/18-28/30)	27/18-28/30	56,250	50
PUZ3840	M8 (38/40)	38/40	62,208	50

PU-Z

Placa de unión para perfiles



METAL



CÓDIGO	MEDIDA	VÁLIDO PARA	€/100		
PGZ2718	27 / 18 x 81	27/18	105,219	50	300
PGZ2830	28 / 30 x 81	28/30	127,427	50	300
PGZ3840	38 / 40 x 93	38/40	142,170	50	100

PG-Z

Puente guía cincado



INOXIDABLE



CÓDIGO	MEDIDA	VÁLIDO PARA	€/100		
PGI2718	27 / 18 x 81	27/18	309,567	50	300
PGI2830	28 / 30 x 81	28/30	356,003	50	200
PGI3840	38 / 40 x 93	38/40	433,393	50	100

PG-A2

Puente guía inoxidable A2



PE-AC

Accesorios para perfiles tipo "C"

SO-TP

Tapones plásticos



METAL



CÓDIGO	MEDIDA	VÁLIDO PARA	€/100		
SOTP2718	27/18	27/18	30,867	100	400
SOTP2830	28/30	28/30	37,123	100	300
SOTP3840	38/40	38/40	60,183	100	300
SOTP4121	41/21	41/21	49,461	100	600
SOTP4141	41/41	41/41	51,858	100	300

GPX

Perfiles para cargas pesadas Indextrut

GP-X 21

Guía perforada Indextrut 41x21



METAL



CÓDIGO	MEDIDA	€/100	LONGITUD	
GPX412115	41 x 21 x 1,5	4.040,640	3.000	10
GPX412120	41 x 21 x 2	4.542,205	3.000	10
GPX412125	41 x 21 x 2,5	6.226,723	3.000	6
GPX2M412120	41 x 21 x 2	3.028,137	2.000	10

GP-X 41

Guía perforada Indextrut 41x41



METAL



CÓDIGO	MEDIDA	€/100	LONGITUD	
GPX414115	41 x 41 x 1,5	4.904,779	3.000	10
GPX414120	41 x 41 x 2	6.997,603	3.000	6
GPX414125	41 x 41 x 2,5	8.572,369	3.000	6
GPX2M414120	41 x 41 x 2	4.665,067	2.000	10

SPX

Soportes para cargas pesadas Indextrut

SP-X

Soporte perforado Indextrut



METAL



CÓDIGO	MEDIDA	€/100	LONGITUD	
SPX412115	41 x 21 x 2,5 x 150	1.053,228	150	10
SPX412130	41 x 21 x 2,5 x 300	1.464,590	300	10
SPX412145	41 x 21 x 2,5 x 450	1.822,771	450	10
SPX414115	41 x 41 x 2,5 x 150	1.351,002	150	10
SPX414130	41 x 41 x 2,5 x 300	1.882,982	300	10
SPX414145	41 x 41 x 2,5 x 450	2.462,330	450	10
SPX414160	41 x 41 x 2,5 x 600	3.095,862	600	10
SPX414175	41 x 41 x 2,5 x 750	3.828,900	750	10
SPX414110	41 x 41 x 2,5 x 1000	4.815,140	1.000	2

SP-RX

Soporte base rectangular "U" Indextrut



METAL



CÓDIGO	MEDIDA	VÁLIDO PARA	€/100	
SPRXH4121	M12 (41/21-41/41)	Indextrut 41/41 - 41/21	1.327,673	12
SPRXV4121	M12 (41/21-41/41)	Indextrut 41/41 - 41/21	1.327,673	12

Soportes para cargas pesadas Indextrut

SPX

METAL



CÓDIGO	MEDIDA	VÁLIDO PARA	€/100	
SPUX412100	M16 (41/21-41/41)	Indextrut 41/41 - 41/21	1.687,073	12
SPUX412145	M16 (41/21-41/41)	Indextrut 41/41 - 41/21	1.687,073	12

SP-UX

Soporte base cuadrada "U" Indextrut



METAL



CÓDIGO	MEDIDA	VÁLIDO PARA	€/100	
PRX01	M8 (41/21-41/41)	Indextrut 41/41 - 41/21	1.465,797	12

PR-X

Soporte regulable Indextrut



METAL



CÓDIGO	MEDIDA	VÁLIDO PARA	€/100		
RESX300	252 x 252 x 6 (300)	Indextrut 41/41 - 41/21	1.184,137	10	20
RESX550	428 x 428 x 6 (550)	Indextrut 41/41 - 41/21	1.886,377	10	20

RE-SX

Refuerzo para soportes Indextrut





Accesorios para perfiles Indextrut

PX-AC

METAL



CÓDIGO	MEDIDA	VÁLIDO PARA	€/100		
SOTP2718	27/18	27/18	30,867	100	400
SOTP2830	28/30	28/30	37,123	100	300
SOTP3840	38/40	38/40	60,183	100	300
SOTP4121	41/21	41/21	49,461	100	600
SOTP4141	41/41	41/41	51,858	100	300

SO-TP

Tapones plásticos



METAL



CÓDIGO	MEDIDA	VÁLIDO PARA	€/100		
TGX0840	M8 x 40	Indextrut 41/41 - 41/21	120,602	100	400
TGX0860	M8 x 60	Indextrut 41/41 - 41/21	131,900	50	300
TGX1040	M10 x 40	Indextrut 41/41 - 41/21	157,303	50	300
TGX1060	M10 x 60	Indextrut 41/41 - 41/21	176,437	50	200

TG-X

Tope tornillo Guía Indextrut



METAL



CÓDIGO	MEDIDA	€/100	
TGRX0830	M8x30	288,477	100
TGRX0860	M8x60	301,673	50
TGRX1030	M10x30	327,923	50
TGRX1060	M10x60	348,140	50

TO-GRX

Tope tornillo Guía de fijación rápida Indextrut



PX-AC

Accesorios para perfiles Indextrut

TU-GX

Tuerca guía Indextrut



METAL



CÓDIGO	MEDIDA	VÁLIDO PARA	€/100		
TUGX08	M8	Indextrut 41/41 - 41/21	72,342	100	800
TUGX10	M10	Indextrut 41/41 - 41/21	79,994	100	800

TU-MU

Tuerca guía Indextrut con muelle



METAL



CÓDIGO	MEDIDA	VÁLIDO PARA	€/100		
TUGXMU08	M8	Indextrut 41/41	105,712	100	400
TUGXMU10	M10	Indextrut 41/41	105,712	100	400

TU-RX

Tuerca guía de fijación Rápida Indextrut



METAL



CÓDIGO	MEDIDA	VÁLIDO PARA	€/100		
TURX08	M8	Indextrut 41/41 - 41/21	100,138	100	400
TURX10	M10	Indextrut 41/41 - 41/21	114,403	100	400
TURX12	M12	Indextrut 41/41 - 41/21	126,870	50	300

TU-RXA

Tuerca guía con arandela de fijación rápida Indextrut



METAL



CÓDIGO	MEDIDA	€/100	
TURXA08	M8	241,683	50
TURXA10	M10	264,186	50

EG-X

Escuadra para Indextrut



METAL



CÓDIGO	MEDIDA	VÁLIDO PARA	€/100	N° AGUJEROS		
EMX4502	86/52 x 40 x 5 45°	Indextrut 41/41 - 41/21	285,427	2	25	125
EMX1302	71/48 x 40 x 5 135°	Indextrut 41/41 - 41/21	303,843	2	20	100
EMX9002	48 x 51 x 5 90°	Indextrut 41/41 - 41/21	186,451	2	50	150
EMX9004	95 x 98 x 5 90°	Indextrut 41/41 - 41/21	294,637	4	25	75

Accesorios para perfiles Indextrut

PX-AC

METAL



CÓDIGO	MEDIDA	VÁLIDO PARA	€/100	
SCRX090	100 x 100 x 40	Indextrut 41/41 - 41/21	727,962	10

SC-RX

Escuadra reforzada Indextrut



METAL



CÓDIGO	MEDIDA	VÁLIDO PARA	€/100	
EMPX4121	M8 (41/21-41/41)	Indextrut 41/41 - 41/21	1.141,718	10

EMP-X

Empalme Indextrut



METAL



CÓDIGO	MEDIDA	VÁLIDO PARA	€/100	
RTX01	50 x 5	41/21 - 41/41 - 41/62	805,347	10



RT-X

Soporte Rótula Indextrut



METAL



CÓDIGO	MEDIDA	€/100	N° AGUJEROS		
UNPX412101	40 x 40 x 5	77,306	1	50	300
UNPX412102	40 x 90 x 5	159,597	2	25	150
UNPX412103	40 x 138 x 5	224,432	3	25	125
UNPX412104	40 x 186 x 5	279,293	4	10	60

UN-PX

Placa de unión Indextrut



METAL



CÓDIGO	MEDIDA	€/100	N° AGUJEROS	
UNEX412103	89 x 89 x 5	406,451	3	25

UN-EX

Placa de unión Escuadra Indextrut



PX-AC

Accesorios para perfiles Indextrut

UN-TX

Placa de unión "T" Indextrut



METAL



CÓDIGO	MEDIDA	€/100	Nº AGUJEROS	
UNTX412104	138 x 89 x 5	528,384	4	25

PG-X

Puente guía Indextrut



METAL



CÓDIGO	MEDIDA	VÁLIDO PARA	€/100		
PGX4121	41/21 x 40	Indextrut 41/21	375,277	15	90
PGX4141	41/41 x 40	Indextrut 41/41	497,395	10	60

AB-GX

Abrazadera para guía perforada Indextrut



METAL



CÓDIGO	MEDIDA	VÁLIDO PARA	€/100	
ABGX4121	41x21 - 41x41	Indextrut 41/41 - 41/21	548,646	20

VE-AC

Accesorios de ventilación

UN-CO

Unión conducto tipo "C"



METAL



CÓDIGO	MEDIDA	€/100		
UNCO3220	32 x 20	60,450	100	400

SO-PG

Perfil de goma isofónico para soportación



METAL



CÓDIGO	MEDIDA	VÁLIDO PARA	€/PC	
SOPG27	27	27/18 - 28/30	152,687	1
SOPG38	38	38/40 - 40/20	217,873	1
SOPG41	41	41/21 - 41/41	222,893	1



SISTEMAS DE INSTALACIÓN Y FIJACIONES PARA PLACAS SOLARES



ISF-GG

Grapas y galgas para montaje de placas

KFR-SC

Grapa fijación rápida



METAL



CÓDIGO	MEDIDA	€/100		
KFRSC3050	30 - 50	583,910	10	240

PGS-A

Perfil grapa



METAL



CÓDIGO	MEDIDA	€/100		
PGSA26	26	95,602	20	720

GM-A

Galga de aluminio para marco



METAL



CÓDIGO	MEDIDA	€/100		
GMA035	35	172,689	10	120
GMA040	40	190,220	10	120
GMA030 NEW	30	166,646	10	120

ISF-PU

Perfiles, uniones, guías y empalmes para estructura de apoyo

GP-XS

Guía perforada INDETRUT solar. Acero Atlantis C4-M



METAL



CÓDIGO	MEDIDA	€/100	
GPXS4115012	41 x 41 x 1,5 - L.125mm	360,934	50
GPXS4115125 NEW	41 x 41 x 1,5 - L.1250mm	2.026,550	10
GPXS4115187 NEW	41 x 41 x 1,5 - L.1875mm	3.008,747	10
GPXS4115250 NEW	41 x 41 x 1,5 - L.2500mm	3.998,713	6
GPXS4115362 NEW	41 x 41 x 1,5 - L.3625mm	5.779,227	6

EMP-XS

Empalme INDETRUT solar. Acero Atlantis C4-M





METAL



CÓDIGO	MEDIDA	€/100	
EMPXS4115	41 x 1,5	369,069	40

METAL



CÓDIGO	MEDIDA	€/100		
GPVD4162012	16 x 20 x 1,20	689,233	50	-

GP-VD NEW

Guía perforada INDEXTRUT solar para fijación en valle discontinua. Acero Atlantis C4-M



METAL



CÓDIGO	MEDIDA	€/100	
PSAA0400	80 x 35 - L.400	1.132,690	20
PSAA1250	80 x 35 - L.1250	3.105,327	2
PSAA1875	80 x 35 - L.1875mm	4.457,927	2
PSAA2500	80 x 35 - L.2500mm	5.962,750	2
PSAA3625	80 x 35 - L.3625mm	8.415,697	2

PSA-A

Perfil de aluminio con alas



METAL



CÓDIGO	MEDIDA	VÁLIDO PARA	€/100	
PSAUN200	200	PSA-UN	363,110	20

PSA-UN

Unión de aluminio para perfil PSA-A



METAL



CÓDIGO	MEDIDA	€/100	
PSAAV0150	90 x 75 - L.150	975,520	20

PSA-AV

Perfil de aluminio con alas para fijación directa discontinua en valle



METAL



CÓDIGO	MEDIDA	€/100	
PSEA601250	47 x 60 - L.1250mm	3.956,283	2
PSEA601875	47 x 60 - L.1875mm	5.842,287	2
PSEA602500	47 x 60 - L.2500mm	7.766,230	2
PSEA603625	47 x 60 - L.3625mm	11.169,717	2

PSE-A

Perfil de aluminio para fijación ensamblada



ISF-PU

Perfiles, uniones, guías y empalmes para estructura de apoyo

PSE-UN

Unión de aluminio para perfil PSE-A



METAL



CÓDIGO	MEDIDA	VÁLIDO PARA	€/100	
PSEUN060200	60 x 200	PSE-A	514,100	20

NEW PSE-C

Perfil de aluminio para fijación ensamblada lateral



METAL



CÓDIGO	MEDIDA	€/100	
PSEC410125	41 x 41 - L.125mm	418,820	20
PSEC410200	41 x 41 - L.200mm	589,513	20
PSEC411250	41 x 41 - L.1250mm	2.902,063	2
PSEC411875	41 x 41 - L.1875mm	4.166,273	2
PSEC412500	41 x 41 - L.2500mm	5.572,777	2
PSEC413625	41 x 41 - L.3625mm	7.786,350	2

NEW PSE-CUN

Unión de aluminio para perfil PSE-C



METAL



CÓDIGO	MEDIDA	€/100	
PSECUN200	200 mm	404,947	10

ISF-CC

Conectores + Complementos para montaje de estructuras solares

KFS-FI

Conector cruzado para fijación inferior. Inoxidable A2



METAL



CÓDIGO	MEDIDA	€/100		
KFSFIM08	M8	165,977	100	900

KFS-FL

Conector cruzado para fijación lateral. Inoxidable A2



METAL





CÓDIGO	MEDIDA	€/100		
KFSFLM08	M8	294,530	10	80

Conectores + Complementos para montaje de estructuras solares

ISF-CC

METAL



CÓDIGO	MEDIDA	€/100		
TURXA208	M8	141,600	50	300

TU-RX A2

Tuerca rápida INDEXTRUT. Inoxidable A2



METAL



CÓDIGO	MEDIDA	€/100		
D603108016	M8 x 16	42,047	200	2.400

DIN-603 A2

Tornillo DIN-603. Cabeza redonda y cuello cuadrado. Inoxidable A2



Disponible en varios recubrimientos. Consulte precio y plazo de entrega.

METAL



CÓDIGO	MEDIDA	€/100	LLAVE DE INSTALACIÓN		
6921108020	M8 x 20	50,523	13	200	2.400
6921108050	M8 x 50	80,817	13	100	600
6921108070	M8 x 70	117,303	13	100	600

DIN-6921 A2

Tornillo DIN-6921. Tornillo hexagonal con arandela estampada y grafilada. Inoxidable A2



METAL



CÓDIGO	MEDIDA	€/100	LLAVE DE INSTALACIÓN		
D6923IM08	M8	24,660	13	250	3.000
D6923IM10	M10	47,753	15	250	3.000
D6923IM12	M12	70,740	18	250	1.500

DIN-6923 A2

Tuerca brida grafilada DIN-6923. Inoxidable A2



METAL



CÓDIGO	MEDIDA	€/100		
D127IM08	M8	4,530	200	9.000
D127IM10	M10	7,237	100	4.500
D127IM12	M12	10,923	100	4.500

DIN-127 A2

Arandela muelle grower DIN-127. Inoxidable A2



ISF-TR

Triángulos para instalación de placas solares

TPA-R

Triángulo regulable de aluminio premontado



METAL



CÓDIGO	MEDIDA	VÁLIDO PARA	€/PC	
TPAR251500	25°/30°/35° - L.1500	PSE-A	57,737	4

TPA-P

Perfil riostra para triángulo de aluminio premontado



METAL



CÓDIGO	MEDIDA	€/100	
TPAP352000	35 x 35 - L.2000	1.535,633	2

TRP-XS

Triángulo regulable premontado INDEXTRUT. Acero con recubrimiento Atlantis C4-M



METAL



CÓDIGO	MEDIDA	VÁLIDO PARA	€/PC	
TRPXS412515	25°-35° - L.1500	GP-XS	56,582	4



NU-XS

Nudo articulado INDEXTRUT. Acero con recubrimiento Atlantis C4-M



METAL





CÓDIGO	MEDIDA	VÁLIDO PARA	€/100		
NUXSM0841	M8	GP-XS	732,827	10	100

Espárragos regulables para la instalación de placas solares

ISF-KFS



CÓDIGO	MEDIDA	€/100	LLAVE DE INSTALACIÓN		
KFSMA10200	10 x 200	555,310	7	25	150
KFSMA10250	10 x 250	626,317	7	25	150
KFSMA12300 NEW	12 x 300	1.214,187	9	25	75
KFSMA12350 NEW	12 x 350	1.321,193	9	25	75

KFS-MA

Espárrago doble rosca. Inoxidable A2



CÓDIGO	MEDIDA	€/100	LLAVE DE INSTALACIÓN		
KFSAU10160	10 x 160	2.496,347	13	25	150
KFSAU10200	10 x 200	2.896,505	13	25	75

KFS-AU

Kit tornillo autorroscante. Inoxidable A2



CÓDIGO	MEDIDA	€/100	LLAVE DE INSTALACIÓN		
KFSRV10250	10 x 250	626,317	7	25	150
KFSRV12350	12 x 350	1.228,876	9	25	75

KFS-RV

Varilla roscada para instalación con anclaje químico. Inoxidable A2



ISF-FR

Accesorios regulables para la instalación de placas solares

GS-TC

Gancho salvateja ajustable para teja curva. Inoxidable A2



METAL



CÓDIGO	MEDIDA	€/100	
GSTC040080	40 - 80	2.659,303	20
GSTC080120	80 - 120	2.709,631	20

GS-TU

Gancho salvateja ajustable para teja universal. Inoxidable A2



METAL



CÓDIGO	MEDIDA	€/100	
GSTU040055	40 - 55	2.872,957	20

STR

Soporte regulable para perfil trapezoidal. Inoxidable A2



METAL



CÓDIGO	MEDIDA	€/100	
STR1680	16 - 80	1.944,180	40

PMO

Placa para tornillo doble rosca. Inoxidable A2



METAL



CÓDIGO	MEDIDA	€/100		
PMO1012	M10 -M12	263,027	25	300

NEW PMO-L

Pletina en "L" de aluminio para fijación lateral. Válida para perfil PSE-C



METAL



CÓDIGO	MEDIDA	€/100	UD. MIN. VENTA	
PMOL1012	M10 -M12	156,117	-	25

Accesorios regulables para la instalación de placas solares

ISF-FR



CÓDIGO	MEDIDA	€/100	UD. MIN. VENTA	
MOTL16330	16 x 330	202,997	-	10

MO-TL **NEW**

Tamiz largo recortable para fijación en cubierta teja + rasillón



CÓDIGO	MEDIDA	€/PC	UD. MIN. VENTA	
MOPC185	185 mm	3,587	-	1

MO-PC **NEW**



Extensor de cánula para fijaciones químicas



Accesorios de fijación directa para la instalación de placas solares

ISF-FD



CÓDIGO	MEDIDA	€/100	Nº HUELLA		
TACN165525	5,5 x 25 P16	41,087	8	500	2.000

TAC + ARVUL

Tornillo de cosido Atlantis C4-M + Arandela vulcanizada EPDM





CÓDIGO	MEDIDA	€/100	Nº HUELLA		
TACB166025	6 x 25 P16	99,783	8	500	2.000

TAC BIMETAL+ARVUL A2

Tornillo de cosido Bimetal + Arandela vulcanizada EPDM-inoxidable A2



CÓDIGO	MEDIDA	€/100		
AUENI166325	6,25 x 25 P-16	38,000	500	2.000

AUE NI + ARVUL **NEW**

Tornillo autorroscante Atlantis C4-M + Arandela vulcanizada EPDM-inoxidable A2



ISF-FD

Accesorios de fijación directa para la instalación de placas solares



NEW DIN-7504-K RE NI + ARVUL

Tornillo autotaladrante punta reducida Atlantis C4-M + Arandela vulcanizada EPDM-inoxidable A2



METAL



CÓDIGO	MEDIDA	€/100			
AREN166325	6,25 x 25 P-16	32,300	8	500	3.000



RE-TE

Remache trebol estanco + Arandela vulcanizada EPDM



METAL



CÓDIGO	MEDIDA	€/100	Ø BROCA		
RETE5220	5,2 x 20	99,830	5,3	250	3.000

ISF-ES

Accesorios de estanqueidad para la instalación de placas solares



ARS-P

Arandela paraguas inoxidable A2 + EPDM



METAL



CÓDIGO	MEDIDA	€/100		
ARSP08	M8	51,876	100	1.200
ARSP10	M10	51,876	100	1.200

ARS-S

Arandela para tornillo doble rosca



METAL



CÓDIGO	MEDIDA	€/100		
ARSS10	M10	25,678	100	1.200
ARSS12	M12	25,678	100	1.200



CS-B

Cinta de estanqueidad de butileno



METAL



CÓDIGO	MEDIDA	€/PC		
CSB0104010	40 x 1 - L.10	20,623	1	27
CSB0108010	80 x 1 - L.10	40,300	1	18

Kits para instalaciones solares

ISF-KT



CÓDIGO	MEDIDA	€/PC	
KCP5A0235	x2 (35 mm) - ORIGEN	190,373	1
KCP5A0240	x2 (40 mm) - ORIGEN	190,373	1
KCP5A0335	x3 (35 mm) - ORIGEN	264,587	1
KCP5A0340	x3 (40 mm) - ORIGEN	264,587	1
KCP5A0230 NEW	x2 (30 mm) - ORIGEN	190,373	1
KCP5A0330 NEW	x3 (30 mm) - ORIGEN	264,587	1
KCP5A03AM NEW	x3 - AMPLIACION	254,907	1
KCP5A02AM NEW	x2 - AMPLIACION	182,307	1

KC-PSA

Coplanar con perfil con alas de aluminio (PSA-A). Fijación directa





CÓDIGO	MEDIDA	€/PC	
KCP5D0135	x1 (35 mm) - ORIGEN	85,378	1
KCP5D0140	x1 (40 mm) - ORIGEN	85,378	1
KCP5D01AM	x1 - AMPLIACION	42,689	1
KCP5D0130	x1 (30 mm) - ORIGEN	85,378	1

KC-PSD

Coplanar con perfil con alas de aluminio (PSA-A). Fijación directa formato de perfil discontinuo



CÓDIGO	MEDIDA	€/PC		
KCP5C0235	x2 (35 mm) - ORIGEN	183,920	1	-
KCP5C02AM	x2 - AMPLIACION	172,498	1	-
KCP5C0240	x2 (40 mm) - ORIGEN	183,920	1	-
KCP5C0335	x3 (35 mm) - ORIGEN	250,760	1	-
KCP5C0340	x3 (40 mm) - ORIGEN	250,760	1	-
KCP5C0330	x3 (30 mm) - ORIGEN	250,760	1	-
KCP5C0230	x2 (30 mm) - ORIGEN	183,920	1	-
KCP5C03AM	x3 - AMPLIACION	240,387	1	-

KC-PSC **NEW**

Coplanar con perfil de aluminio PSE-C. Fijación ensamblada lateral



CÓDIGO	MEDIDA	€/PC	
KCGPX0235	x2 (35 mm) - ORIGEN	154,000	1
KCGPX0240	x2 (40 mm) - ORIGEN	154,000	1
KCGPX0335	x3 (35 mm) - ORIGEN	210,540	1
KCGPX0340	x3 (40 mm) - ORIGEN	210,540	1
KCGPX0330 NEW	x3 (30 mm) - ORIGEN	210,540	1
KCGPX03AM NEW	x3 - AMPLIACION	205,333	1
KCGPX0230 NEW	x2 (30 mm) - ORIGEN	154,000	1
KCGPX02AM NEW	x2 - AMPLIACION	148,830	1

KC-GPX

Coplanar con guía perforada acero Atlantis C4-M INDEXTRUT SOLAR GP-XS



ISF-KT

Kits para instalaciones solares

KC-GPD

Coplanar con guía perforada Atlantis C4-M INDEXTRUT SOLAR GP-XS. Formato guía discontinua



CÓDIGO	MEDIDA	€/PC	
KCGPD0135	x1 (35 mm) - ORIGEN	52,250	1
KCGPD0140	x1 (40 mm) - ORIGEN	52,250	1
KCGPD01AM	x1 - AMPLIACION	24,384	1
KCGPD0130	x1 (30 mm) - ORIGEN	52,250	1

KT-PSE

Triangular con perfil de aluminio PSE-A. Fijación ensamblada



CÓDIGO	MEDIDA	€/PC	
KTPSE0235	x2 (35 mm) - ORIGEN	380,747	1
KTPSE0240	x2 (40 mm) - ORIGEN	380,747	1
KTPSE0335	x3 (35 mm) - ORIGEN	542,080	1
KTPSE0340	x3 (40 mm) - ORIGEN	542,080	1
KTPSE0330	x3 (30 mm) - ORIGEN	542,080	1
KTPSE03AM	x3 - AMPLIACION	529,173	1
KTPSE0230	x2 (30 mm) - ORIGEN	380,747	1
KTPSE02AM	x2 - AMPLIACION	375,907	1

KT-GPX

Triangular con guía perforada Atlantis C4-M INDEXTRUT SOLAR GP-XS



CÓDIGO	MEDIDA	€/PC	
KTGPX0235	x2 (35 mm) - ORIGEN	285,450	1
KTGPX0240	x2 (40 mm) - ORIGEN	285,450	1
KTGPX0335	x3 (35 mm) - ORIGEN	409,200	1
KTGPX0340	x3 (40 mm) - ORIGEN	409,200	1
KTGPX0230	x2 (30 mm) - ORIGEN	285,450	1
KTGPX02AM	x2 - AMPLIACION	277,200	1
KTGPX03AM	x3 - AMPLIACION	402,600	1
KTGPX0330	x3 (30 mm) - ORIGEN	409,200	1



SISTEMAS DE FIJACIÓN RÁPIDA EN VIGA





SU

Sistemas de fijación rápida en viga

SU-MO

Mordaza para viga



CÓDIGO	MEDIDA	€/100	ANCHO MÁX. A LA VIGA		
SUMOP09	PASANTE Ø9	371,059	20	50	200
SUMOP11	PASANTE Ø11	424,970	20	50	150
SUMOP13	PASANTE Ø13	646,837	25	50	100
SUMOM06	ROSCADO M6	331,673	20	50	200
SUMOM08	ROSCADO M8	371,059	20	50	200
SUMOM10	ROSCADO M10	424,970	20	50	150
SUMOM12	ROSCADO M12	646,837	25	50	-

SU-CL

Clip de suspensión



CÓDIGO	MEDIDA	€/100	LONGITUD MIN. ALA VIGA	ESPESOR VIGA		
SUCL02	6.3	38,577	14	1,5 - 4	100	1.200
SUCL04	6.3	55,177	23	4 - 10	100	400
SUCL10	6.3	64,260	23	10 - 15	100	300
SUCL15	6.3	85,677	23	15 - 20	100	300

SU-VA

Clip varilla



CÓDIGO	MEDIDA	€/100	LONGITUD MIN. ALA VIGA	ESPESOR VIGA		
SUVA0602	M6	99,043	14	1,5 - 4	100	300
SUVA0604	M6	120,650	23	4 - 10	100	200
SUVA0610	M6	177,473	23	10 - 15	100	-
SUVA0615	M6	214,197	23	15 - 20	100	-
SUVA0802	M8	99,043	14	1,5 - 4	100	300
SUVA0804	M8	120,650	23	4 - 10	100	200
SUVA0810	M8	177,473	23	10 - 15	100	200
SUVA0815	M8	214,197	23	15 - 20	100	-

Sistemas de fijación rápida en viga

SU

 Info
Técnica
P. 433



CÓDIGO	MEDIDA	€/100	ESPESOR VIGA		
SUCU0602	M6	99,483	1,5 - 5	100	300
SUCU0605	M6	110,570	5 - 7	100	300
SUCU0606	M6	138,413	3 - 7	100	200
SUCU0607	M6	163,147	7 - 10	100	200

SU-CU

Clip de cuelgue



 Info
Técnica
P. 433



CÓDIGO	MEDIDA	€/100	MEDIDA TORNILLO	ESPESOR MÁX. A FIJAR	ANCHO MÁX. A LA VIGA		
SUAB0603	M6	94,023	M6 x 9	3 - 7	3 - 7	100	300
SUAB0607	M6	94,397	M6 x 9	7 - 13	7 - 13	100	200
SUAB0614	M6	98,353	M6 x 9	14 - 20	14 - 20	100	200

SU-AB

Clip de viga para abrazadera



 Info
Técnica
P. 433



CÓDIGO	MEDIDA	€/100	ESPESOR MÁX. A FIJAR		
SUCA0602	6-7	32,513	1 - 4	100	2.400
SUCA0604	6-7	33,260	4 - 7,5	100	1.200
SUCA0607	6-7	33,777	7,5 - 12	100	1.200
SUCA0802	8-9	33,887	1 - 4	100	1.200
SUCA0804	8-9	34,407	4 - 7,5	100	1.200
SUCA0807	8-9	34,840	7,5 - 12	100	1.200
SUCA1002	10-11	34,567	1 - 4	100	1.200
SUCA1004	10-11	35,100	4 - 7,5	100	1.200
SUCA1007	10-11	35,563	7,5 - 12	100	1.200
SUCA1202	12-14	35,387	1 - 4	100	1.200
SUCA1204	12-14	35,900	4 - 7,5	100	1.200
SUCA1207	12-14	36,033	7,5 - 12	100	1.200
SUCA1502	15-18	36,157	1 - 4	100	1.200
SUCA1504	15-18	36,933	4 - 7,5	100	1.200
SUCA1507	15-18	37,083	7,5 - 12	100	1.200
SUCA1902	19-24	36,997	1 - 4	100	1.200
SUCA1904	19-24	44,830	4 - 7,5	100	600
SUCA1907	19-24	45,700	7,5 - 12	100	600
SUCA2502	25-30	46,080	1 - 4	100	600
SUCA2504	25-30	51,403	4 - 7,5	100	600
SUCA2507	25-30	56,287	7,5 - 12	100	600

SU-CA

Clip de viga para cable





VARILLA ROSCADA Y ACCESORIOS DE FIJACIÓN





RV

Varilla roscada

RV-ZN

METAL



Cincada. 1 metro

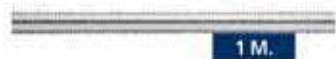

CÓDIGO	MEDIDA	€/100	LONGITUD	PASO	
975ZM04	M4 x 1000	92,641	1.000	0.7	100
975ZM05	M5 x 1000	132,873	1.000	0.8	100
975ZM06	M6 x 1000	123,400	1.000	1	100
975ZM08	M8 x 1000	206,733	1.000	1.25	50
975ZM10	M10 x 1000	311,565	1.000	1.5	25
975ZM12	M12 x 1000	483,990	1.000	1.75	20
975ZM14	M14 x 1000	693,699	1.000	2	10
975ZM16	M16 x 1000	915,523	1.000	2	10
975ZM18	M18 x 1000	1.246,421	1.000	2.5	10
975ZM20	M20 x 1000	1.550,628	1.000	2.5	5
975ZM22	M22 x 1000	2.159,881	1.000	2.5	5
975ZM24	M24 x 1000	2.328,040	1.000	3	5
975ZM27	M27 x 1000	2.838,397	1.000	3	5
975ZM30	M30 x 1000	3.553,570	1.000	3.5	5
975ZM33	M33 x 1000	4.372,797	1.000	3.5	3
975ZM36	M36 x 1000	6.319,280	1.000	4	3

RV-ZN 8.8

METAL



Cincada. Calidad 8.8. 1 metro



CÓDIGO	MEDIDA	€/100	LONGITUD	PASO	
9758ZM05	M5 x 1000	184,423	1.000	0.8	100
9758ZM06	M6 x 1000	183,996	1.000	1	100
9758ZM08	M8 x 1000	327,750	1.000	1.25	50
9758ZM10	M10 x 1000	508,073	1.000	1.5	25
9758ZM12	M12 x 1000	700,967	1.000	1.75	20
9758ZM14	M14 x 1000	1.011,416	1.000	2	10
9758ZM16	M16 x 1000	1.261,587	1.000	2	10
9758ZM18	M18 x 1000	1.675,184	1.000	2.5	5
9758ZM20	M20 x 1000	2.165,452	1.000	2.5	5
9758ZM22	M22 x 1000	2.857,517	1.000	2.5	5
9758ZM24	M24 x 1000	3.055,550	1.000	3	5
9758ZM27	M27 x 1000	3.801,180	1.000	3	5
9758ZM30	M30 x 1000	5.057,910	1.000	3.5	5
9758ZM33	M33 x 1000	6.428,013	1.000	3.5	3
9758ZM36	M36 x 1000	8.324,213	1.000	4	3

RV-A2

INOXIDABLE



Inoxidable A2. 1 metro



CÓDIGO	MEDIDA	€/100	LONGITUD	PASO	
975A2M04	M4 x 1000	342,703	1.000	0.7	1
975A2M05	M5 x 1000	404,100	1.000	0.8	1
975A2M06	M6 x 1000	557,927	1.000	1	1
975A2M08	M8 x 1000	905,410	1.000	1.25	1
975A2M10	M10 x 1000	1.311,617	1.000	1.5	1
975A2M12	M12 x 1000	1.996,787	1.000	1.75	1
975A2M14	M14 x 1000	3.496,623	1.000	2	1
975A2M16	M16 x 1000	4.037,627	1.000	2	1
975A2M18	M18 x 1000	4.404,683	1.000	2.5	1
975A2M20	M20 x 1000	6.078,463	1.000	2.5	1
975A2M22	M22 x 1000	7.105,490	1.000	2.5	1
975A2M24	M24 x 1000	9.591,407	1.000	3	1
975A2M27	M27 x 1000	11.559,623	1.000	3	1
975A2M30	M30 x 1000	17.990,670	1.000	3.5	1
975A2M33	M33 x 1000	22.586,227	1.000	3.5	1
975A2M36	M36 x 1000	25.977,823	1.000	4	1



Varilla roscada

RV

METAL



RV-2M

Cincada. 2 metros

CÓDIGO	MEDIDA	€/100	LONGITUD	PASO	
975ZM2M06	M6 x 2.000	246,800	2.000	1	50



2 M.

Espárrago separador

VR-SE

METAL



CÓDIGO	MEDIDA	€/100		
VRSE06020	M6 x 20	12,260	200	4,800
VRSE06030	M6 x 30	17,240	200	4,800
VRSE08020	M8 x 20	16,033	200	3,200
VRSE08030	M8 x 30	21,473	200	2,400
VRSE10030	M10 x 30	31,530	200	2,400
VRSE12030	M12 x 35	64,633	100	800



Bolsa autoservicio

CÓDIGO	MEDIDA	€/BOLSA	PCS	BOLSAS
LSVRSE06030	M6 x 30	6,670	30	8

Manguito de unión

MA

METAL



MA-HE

Hexagonal

CÓDIGO	MEDIDA	€/100	LONGITUD		
MAE0620	M6 x 20	18,588	20	200	2.400
MAE0630	M6 x 30	26,953	30	200	1.600
MAE0825	M8 x 25	21,831	25	200	1.600
MAE1030	M10 x 30	29,358	30	150	900
MAE1235	M12 x 35	67,104	35	100	600
MAE1650	M16 x 50	204,787	50	50	100
MAE2060	M20 x 60	531,101	60	25	-



Blíster

CÓDIGO	MEDIDA	€/BOLSA	PCS	BOLSAS
BZMAE0630	M6 x 30	2,459	6	15
BZMAE0825	M8 x 25	2,459	6	15
BZMAE1030	M10 x 30	2,459	4	15

Caja ventana

CÓDIGO	MEDIDA	€/CAJA	PCS	CAJAS
VMAE0630	M6 x 30	7,094	20	8
VMAE0825	M8 x 25	5,726	20	8
VMAE1030	M10 x 30	6,066	15	8

Bolsa autoservicio

CÓDIGO	MEDIDA	€/BOLSA	PCS	BOLSAS
LSMAE0630	M6 x 30	12,297	40	6
LSMAE0825	M8 x 25	7,515	30	5
LSMAE1030	M10 x 30	6,733	20	6



MA

Manguito de unión

MA-RE

Redondo



METAL



CÓDIGO	MEDIDA	€/100	LONGITUD		
MAR5322	5/32W x 20	25,643	20	200	4.800
MAR0420	M4 x 20	17,207	20	200	4.800
MAR0620	M6 x 20	17,246	20	200	2.400
MAR0630	M6 x 30	25,618	30	200	1.600
MAR0825	M8 x 25	21,831	25	200	2.400
MAR0830	M8 x 30	27,073	30	200	1.600
MAR1030	M10 x 30	29,787	30	150	900
MAR1235	M12 x 35	50,330	35	100	600
MAR1650	M16 x 50	179,630	50	50	300

Caja ventana

CÓDIGO	MEDIDA	€/CAJA	PCS	CAJAS
VMAR0420	M4 x 20	5,471	25	8
VMAR0630	M6 x 30	6,861	20	8
VMAR0830	M8 x 30	7,103	20	8
VMAR1030	M10 x 30	5,789	15	8

Bolsa autoservicio

CÓDIGO	MEDIDA	€/BOLSA	PCS	BOLSAS
LSMAR0420	M4 x 20	7,653	40	8
LSMAR0630	M6 x 30	12,006	40	7
LSMAR0830	M8 x 30	10,874	35	5
LSMAR1030	M10 x 30	6,755	20	6

MA-RI

Redondo. Inoxidable A2



INOXIDABLE



CÓDIGO	MEDIDA	€/100	LONGITUD	
MARI0830	M8 x 30	204,683	30	100
MARI1030	M10 x 30	281,790	30	100

MA-MH

Separador macho-hembra especial para cuadros eléctricos



METAL



CÓDIGO	MEDIDA	€/100	LONGITUD		
MAMH0610	M6 x 10	44,927	10	100	3.000
MAMH0620	M6 x 20	55,248	20	100	1.200
MAMH0630	M6 x 30	88,027	30	100	1.200
MAMH0640	M6 x 40	102,153	40	100	1.000
MAMH0650	M6 x 50	114,210	50	50	1.000

AR-FO

Argolla forjada



METAL



CÓDIGO	MEDIDA	€/100	LONGITUD DE LA ROSCA	Ø OJO		
ARFOM06Z	M6 x 55	81,027	55	10	100	1.200
ARFOM08Z	M8 x 60	108,623	60	11.8	100	600
ARFOM10Z	M10 x 73	153,213	73	14.5	50	300
ARFOM12Z	M12 x 90	295,803	90	17	50	200
ARFOM16Z	M16 x 95	666,417	95	23.5	25	50



Gancho forjado

GA-FO

METAL



CÓDIGO	MEDIDA	€/100	LONGITUD	LONGITUD DE LA ROSCA	APERTURA GANCHO		
GAFOM06Z	M6 x 55	74,687	82	55	8	100	1.200
GAFOM08Z	M8 x 60	122,840	98	60	10	100	600
GAFOM10Z	M10 x 73	201,100	117	73	12.5	50	300
GAFOM12Z	M12 x 90	349,063	146	90	16	50	100
GAFOM16Z	M16 x 95	693,717	170	95	19	25	50



Gancho espiral

GE-SP

METAL



CÓDIGO	MEDIDA	€/100	LONGITUD DE LA ROSCA		
GESPM08ZE	M8 x 60	145,190	65	25	300
GESPM10ZE	M10 x 73	161,370	78	15	90



Tirafondo abrazadera y grapa

TAG



SANEAMIENTO



AB-TA

Cincado. Ranurado

CÓDIGO	MEDIDA	€/100		
ABTA0630	M6 x 30	5,267	100	4,500
ABTA0640	M6 x 40	6,455	100	2,400
ABTA0650	M6 x 50	7,294	100	2,400
ABTA0730	M7 x 30	5,233	100	2,400
ABTA0740	M7 x 40	6,455	100	2,400
ABTA0750	M7 x 50	7,294	100	2,400
ABTA0760	M7 x 60	12,626	100	1,200
ABTA0770	M7 x 70	16,634	100	1,200
ABTA0780	M7 x 80	18,277	100	1,200
ABTA0840	M8 x 40	8,784	100	2,400
ABTA0860	M8 x 60	11,953	100	1,200
ABTA0880	M8 x 80	17,166	100	1,200
ABTA1050	M10 x 50	20,100	100	1,200
ABTA1070	M10 x 70	25,686	100	800
ABTA1090	M10 x 90	32,660	100	600

*No incorpora ranura



Bolsa autoservicio

CÓDIGO	MEDIDA	€/BOLSA	PCS	BOLSAS
LSABTA0630	M6 x 30	2,638	15	10
LSABTA0640	M6 x 40	2,799	15	10
LSABTA0650	M6 x 50	2,970	15	10
LSABTA0840	M8 x 40	3,481	15	10
LSABTA0860	M8 x 60	3,809	15	10



SANEAMIENTO



AB-TA B

Bicromatado. Ranurado

CÓDIGO	MEDIDA	€/100		
ABTAB0630	M6 x 30	5,267	100	4,500
ABTAB0640	M6 x 40	6,455	100	2,400
ABTAB0650	M6 x 50	7,294	100	2,400



Bolsa autoservicio

CÓDIGO	MEDIDA	€/BOLSA	PCS	BOLSAS
LSABTAB0630	M6 x 30	2,638	15	10
LSABTAB0640	M6 x 40	2,799	15	10
LSABTAB0650	M6 x 50	2,970	15	10



TAG

Tirafondo abrazadera y grapa

AB-TA A2

Inoxidable A2



INOXIDABLE



CÓDIGO	MEDIDA	€/100		
ABTA20630	M6 x 30	84,600	100	2.400

AB-TR

Tornillo doble para abrazaderas



SANEAMIENTO



CÓDIGO	MEDIDA	€/100		
ABTR05030	M5 x 30	10,850	100	2.400
ABTR05040	M5 x 40	11,237	100	2.400
ABTR05050	M5 x 50	12,523	100	2.400
ABTR05060	M5 x 60	14,837	100	1.200
ABTR06040	M6 x 40	14,337	100	2.400
ABTR06050	M6 x 50	17,387	100	1.200
ABTR06060	M6 x 60	19,967	100	1.200

AB-PM7

Prolongador cilíndrico para abrazaderas M7



SANEAMIENTO



CÓDIGO	MEDIDA	€/100		
ABPM720	20	112,693	50	2.250
ABPM730	30	147,677	50	2.250
ABPM740	40	166,307	50	1.200

AB-TG

Tirafondo grapa. Huella combi



SANEAMIENTO



CÓDIGO	MEDIDA	€/100		UD. MIN. VENTA		
ABTG4530	4,5 x 30	7,477	PZ2	200	100	4.500
ABTG4535	4,5 x 35	7,957	PZ2	200	100	4.500
ABTG4540	4,5 x 40	8,287	PZ2	200	100	2.400
ABTG5030	5 x 30	9,389	PZ3	200	100	2.400
ABTG5040	5 x 40	9,940	PZ3	200	100	2.400

TM-VR

Tornillo manguito para varilla roscada



SANEAMIENTO



CÓDIGO	MEDIDA	€/100		
TMVR06065	6 x 65	159,717	50	1.200
TMVR07065	7 x 65	167,330	50	1.200
TMVR08065	8 x 65	170,723	50	1.200



Espárrago de doble rosca

ES-DR



SANEAMIENTO



ES-DR

Cincado. TX

CÓDIGO	MEDIDA	€/100	LLAVE DE INSTALACIÓN		
ESDR06040	M6 x 40	10,019	-	100	3.000
ESDR06050	M6 x 50	11,946	-	100	2.400
ESDR06060	M6 x 60	13,792	-	100	2.400
ESDR06070	M6 x 70	16,134	-	100	1.600
ESDR06080	M6 x 80	18,058	-	100	1.600
ESDR08050	M8 x 50	13,000	-	100	1.600
ESDR08060	M8 x 60	14,959	-	100	800
ESDR08070	M8 x 70	18,073	-	100	800
ESDR08080	M8 x 80	19,229	6	100	800
ESDR08090	M8 x 90	23,102	6	100	800
ESDR08100	M8 x 100	23,779	6	100	800
ESDR08110	M8 x 110	26,887	6	100	800
ESDR08120	M8 x 120	33,697	6	100	800
ESDR08130	M8 x 130	39,364	6	100	800
ESDR10080	M10 x 80	31,803	8	100	800
ESDR10100	M10 x 100	38,954	8	100	400
ESDR10110	M10 x 110	43,403	8	100	400
ESDR10120	M10 x 120	52,599	8	100	400
ESDR10130	M10 x 130	67,404	8	100	400
ESDR10140	M10 x 140	71,733	8	100	400
ESDR10150	M10 x 150	75,914	8	100	400
ESDR10180	M10 x 180	104,680	8	100	300
ESDR10200	M10 x 200	116,377	8	100	200



Bolsa autoservicio

CÓDIGO	MEDIDA	€/BOLSA	PCS	BOLSAS
LSESDR06080	M6 x 80	4,977	25	7
LSESDR08060	M8 x 60	5,102	25	7
LSESDR08080	M8 x 80	6,325	25	6
LSESDR08100	M8 x 100	7,457	25	6
LSESDR08120	M8 x 120	7,582	20	6
LSESDR10080	M10 x 80	7,168	20	6
LSESDR10100	M10 x 100	7,793	18	6
LSESDR10120	M10 x 120	8,237	15	7



INOXIDABLE



ES-DA2

Inoxidable A2. TX

CÓDIGO	MEDIDA	€/100	LLAVE DE INSTALACIÓN		
ESDA208060	M8 x 60	123,333	6	100	800
ESDA210060	M10 x 60	208,583	8	100	800



Florón para abrazaderas

AB-F

SANEAMIENTO



AB-FP

Florón plano para abrazaderas

CÓDIGO	MEDIDA	€/100		
ABFP25	25	7,023	100	2.400
ABFP32	32	10,330	100	2.400





AB-F

Florón para abrazaderas

AB-FC

Florón cónico para abrazaderas



SANEAMIENTO



CÓDIGO	MEDIDA	€/100		
ABFC09	9	11,393	100	2.400
ABFC14	14	17,757	100	1.200
ABFC19	19	28,317	100	1.200

PF

Pletina de fijación

PF-ZN

Cincada



METAL



CÓDIGO	MEDIDA	€/100		
PFZNM0800	M8	52,292	100	600
PFZNM0810	M8+M10	66,443	100	600
PFZNM1000	M10	63,920	100	600

PF-A4

Inoxidable A4



INOXIDABLE



CÓDIGO	MEDIDA	€/100		
PFA4M0800	M8	303,137	100	600
PFA4M0810	M8+M10	361,303	100	600
PFA4M1000	M10	346,320	100	600

ABE-R

Tornillo punta broca con rosca macho y accesorios

NEW ABE-RM

Tornillo punta broca. Rosca macho



METAL



CÓDIGO	MEDIDA	€/100		
ABERM06006	M6 x 5	60,510	200	2.400
ABERM08010	M8 x 10	89,787	100	1.200
ABERM08015	M8 x 15	97,440	100	1.200

NEW ABE-BO

Boca hexagonal para el ABE-RM



METAL

CÓDIGO	MEDIDA	€/100		
ABEB010	10 mm.	1.466,667	5	150
ABEB013	13 mm.	1.466,667	5	150



FIJACIÓN PARA SANITARIOS Y CLIMATIZACIÓN



RA

Soportes para radiadores de aluminio

RA-TRG

Soporte triangular regulable con goma antivibraciones. 2 PCS x KIT



SANEAMIENTO

CÓDIGO	MEDIDA	€/KIT	KITS x
RATRG095	95	4,371	50

TAMBIÉN DISPONIBLE EN

TN4S
Con taco de multimaterial de alta calidad

RA-TRI

Soporte triangular 1°



SANEAMIENTO

CÓDIGO	MEDIDA	€/100	KITS x
RATRI095	95	135,550	100

RA-FRE

Soporte ferroli recto. 2 PCS x KIT



SANEAMIENTO

CÓDIGO	MEDIDA	€/KIT	KITS x
RAFRE095	95	4,329	50

TN4S
Con taco de multimaterial de alta calidad

RA-FIN

Soporte ferroli inclinado. 2 PCS x KIT



SANEAMIENTO

CÓDIGO	MEDIDA	€/KIT	KITS x
RAFIN100	100	4,486	50

TN4S
Con taco de multimaterial de alta calidad

Soportes para radiadores de aluminio

RA

SANEAMIENTO

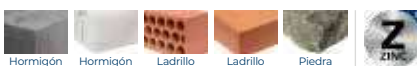

CÓDIGO	MEDIDA	€/KIT	KITS
RAR0100	100	6,952	50

TN4S
Con taco de multimaterial de alta calidad

RA-RO

Soporte Roca. 2 PCS x KIT



SANEAMIENTO

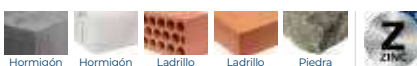

CÓDIGO	MEDIDA	€/100	KITS
RAFEM145	145	124,083	250
RAFEM175	175	133,036	250

RA-FEM

Soporte ferrolli para empotrar



SANEAMIENTO

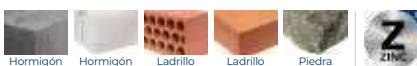

CÓDIGO	MEDIDA	€/100	KITS
RARAY032	32 x 78	101,564	250

RA-RAY

Soporte Rayco



SANEAMIENTO

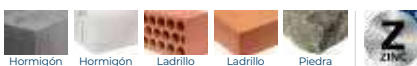

CÓDIGO	MEDIDA	€/100	KITS
RAPES032	32 x 78	110,514	250

RA-PES

Soporte de pestaña



22 KITS SOLUCIONES

easykits

AUMENTA LA VENTA CRUZADA
PACKAGING MUY VISUAL Y ATRACTIVO
INFORMACIÓN ÚTIL EN EL PACKAGING
SOLUCIONES A PRODUCTOS HABITUALES

SA

Soportes de fijación para sanitarios

SA-LN

Fijación de lavabos con tuerca de nylon. 2 PCS x KIT



TN4S
Con taco de multimaterial de alta calidad

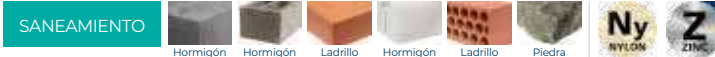

CÓDIGO	MEDIDA	€/KIT	KITS x
SALN08100	M8 x 100	2,205	50
SALN10120	M10 x 120	2,674	50

SA-LH

Fijación de lavabos con tuerca de hierro. 2 PCS x KIT



TAMBIÉN DISPONIBLE EN
easykits
TN4S
Con taco de multimaterial de alta calidad



CÓDIGO	MEDIDA	€/KIT	KITS x
SALH08100	M8 x 100	2,202	100
SALH10120	M10 x 120	3,128	50

SA-IL

Fijación de WC y bidé con taco largo. 2 PCS x KIT

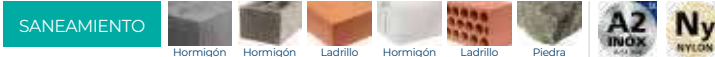

CÓDIGO	MEDIDA	€/KIT	KITS x
SAIL06080	M6 x 80	2,926	100

SA-WZ

Fijación WC y bidé, cincado. 2 PCS x KIT



TN4S
Con taco de multimaterial de alta calidad



CÓDIGO	MEDIDA	€/KIT	KITS x
SAW05080	M5 x 80	1,213	300

SA-WL

Fijación WC y bidé, latón. 2 PCS x KIT



TN4S
Con taco de multimaterial de alta calidad

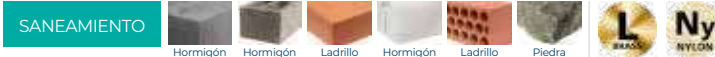

CÓDIGO	MEDIDA	€/KIT	KITS x
SAWL05080	M5 x 80	3,091	100

Soportes de fijación para sanitarios

SA

SANEAMIENTO



CÓDIGO	MEDIDA	€/KIT	KITS
SACI06080	M6 x 80	5,727	100

TAMBIÉN DISPONIBLE EN
easykits

SA-CI

Fijación de cisterna. 2 PCS x KIT



SANEAMIENTO



CÓDIGO	MEDIDA	€/KIT	KITS
SAWH06070	M6 x 70	2,498	50

TN4S
Con taco de multimaterial de alta calidad

SA-WH

Fijación de WC horizontal. 2 PCS x KIT



SANEAMIENTO



CÓDIGO	MEDIDA	€/KIT	KITS
SAWHM06060	Ø6x60	5,402	50

TN4S
Con taco de multimaterial de alta calidad

SA-WHM

Fijación WC horizontal multiposición. 2 PCS x KIT



SANEAMIENTO



CÓDIGO	MEDIDA	€/100	KITS
SATEB0860	Ø8x60	129,406	50
SATEB1080	Ø10x80	218,246	50

TN4S
Con taco de multimaterial de alta calidad

SA-TE TB

Fijación de termos y calentadores. Tornillo. 2 PCS x KIT



SANEAMIENTO



CÓDIGO	MEDIDA	€/100	KITS
SATEA0865	Ø8x65	117,518	50
SATEA1075	Ø10x75	176,543	50

TN4S
Con taco de multimaterial de alta calidad

SA-TE AL

Fijación de termos y calentadores. Alcayata. 2 PCS x KIT



CO

Soporte para aire acondicionado

CO-SO

Juego soporte aire acondicionado. 2 PCS x KIT



SANEAMIENTO



CÓDIGO	MEDIDA	€/KIT	KITS x 
COSO15400	1,5 x 400	36,131	1
COSO15450	1,5 x 450	39,332	1
COSO15500	1,5 x 500	48,455	1
COSO20400	2 x 400	54,927	1
COSO20450	2 x 450	59,154	1
COSO20500	2 x 500	60,441	1



CO-KS

Kit silent block soporte AC. 4 PCS x KIT



SANEAMIENTO



CÓDIGO	MEDIDA	€/KIT	KITS x 
COKS08060	M8 x 60	8,151	1



EASYKITS

easykits
Fijaciones techo gancho
Hook ceiling fixings
Fixations pour plafond crochet
Macizo | Solid | Solide

easy
Fijaciones te...
Light ceiling
Fixations pour pl...
Hueco | Hollow
25kg

INDEX
A PERFECT FIXING

easykits
Lavabos
Washbassins | Lavabos
Multimaterial
Multimaterial | Multimateriaux
Cargas medias
Medium loads
Charges moyennes
INDEX
A PERFECT FIXING

easy
Fijaciones
Heavy c...
Fixations po...
Macizo | S...
185kg

INDEX
A PERFECT FIXING

INDEX
A PERFECT FIXING
35kg
Cargas altas
Heavy loads
Charges élevées

INDEX
A PERFECT FIXING

INDEX
A PERFECT FIXING

easykits
Fijaciones accesorios pesados
Heavy accessories fixings
Fixations accessoires lourds
Multimaterial
Multimaterial | Multimateriaux
120kg
40kg
Cargas altas
Heavy loads
Charges élevées
INDEX
A PERFECT FIXING

easykits
Fijaciones techo ligeras
Light ceiling fixings
Fixations pour plafond léger
Macizo | Solid | Solide
90kg
Cargas ligeras
Light loads
Charges légères
INDEX
A PERFECT FIXING

easykits
Fijaciones accesorios exterior
Outdoor accessories fixings
Fixations accessoires extérie...
Multimaterial
Multimaterial | Multimateriaux
20kg
Cargas...
Char...
INDEX
A PERFECT FIXING

**easy
kits**

EKMULCAN

Canaletas - Rodapiés



MULTIMATERIAL



CÓDIGO	COMPONENTES	MEDIDA COMPONENTES	UDS X BOLSA	€/BOLSA	Nº MINIMO VENTA
EKMULCAN	TCCA05.050	5 x 50 Ø5	8	5,103	12
	BROCA GRATIS	5 x 85	1		

EKMULFAE

Fijacones accesorios exterior



MULTIMATERIAL



CÓDIGO	COMPONENTES	MEDIDA COMPONENTES	UDS X BOLSA	€/BOLSA	Nº MINIMO VENTA
EKMULFAE	TN4506	6 x 30 Ø6	4	5,103	12
	TPA240.050	4 x 50	4		
	BROCA GRATIS	6 x 100	1		

EKMULTEN

Tendederos - Antenas - AC



MULTIMATERIAL



CÓDIGO	COMPONENTES	MEDIDA COMPONENTES	UDS X BOLSA	€/BOLSA	Nº MINIMO VENTA
EKMULTEN	TN4508	8 x 40 Ø8	4	7,233	12
	TBA206.050	6 x 50	4		
	125IM06	M6	4		
	BROCA GRATIS	8 x 120	1		

EKMULAC

Aparatos de aire acondicionado



MULTIMATERIAL



CÓDIGO	COMPONENTES	MEDIDA COMPONENTES	UDS X BOLSA	€/BOLSA	Nº MINIMO VENTA
EKMULAC	TNUXE10.080	10 x 80 Ø10	4	5,226	12
	TN4506	6 x 30 Ø6	4		
	D12.505	M5	4		
	T8142.038	4,2 x 38	4		

EKMULTOL

Toldos



MULTIMATERIAL



CÓDIGO	COMPONENTES	MEDIDA COMPONENTES	UDS X BOLSA	€/BOLSA	Nº MINIMO VENTA
EKMULTOL	TNUXE08.080	8 x 80 Ø8	4	7,394	12
	BROCA GRATIS	8 x 120	1		

MULTIMATERIAL



CÓDIGO	COMPONENTES	MEDIDA COMPONENTES	UDS X BOLSA	€/BOLSA	N° MINIMO VENTA
EKMULCAL	TN4S10	10 x 50 Ø10	2	7,233	12
	TB06.060	4 x 50	2		
	ALRO22.100	22x100 (6 x 79 x 23)	2		
	BROCA GRATIS	10 x 120	1		

EKMULCAL

Calderas - Calentadores



MULTIMATERIAL



CÓDIGO	COMPONENTES	MEDIDA COMPONENTES	UDS X BOLSA	€/BOLSA	N° MINIMO VENTA
EKMULAV08	SALH08.100	M8 x 100	2	7,233	12
	BROCA GRATIS	8 x 120	11		
EKMULAV10	SALH10.120	M10 x 120	2	10,848	12
	BROCA GRATIS	10 x 120	1		

EKMULAV

Lavabos



MULTIMATERIAL



CÓDIGO	COMPONENTES	MEDIDA COMPONENTES	UDS X BOLSA	€/BOLSA	N° MINIMO VENTA
EKMULCIS	SACIO6.080	M6 x 80	2	10,848	12

EKMULCIS

Cisternas WC



MULTIMATERIAL



CÓDIGO	COMPONENTES	MEDIDA COMPONENTES	UDS X BOLSA	€/BOLSA	N° MINIMO VENTA
EKMULWCB	SAWZ05.080	M5 x 80	2	7,233	12
	BROCA GRATIS	8 x 120	1		

EKMULWCB

WC - Bidés



MULTIMATERIAL



CÓDIGO	COMPONENTES	MEDIDA COMPONENTES	UDS X BOLSA	€/BOLSA	N° MINIMO VENTA
EKMULRAD	RATRG095	95	2	13,560	12
	BROCA GRATIS	8 x 120	1		

EKMULRAD

Radiadores



EKMULROB

Antirrobo



MULTIMATERIAL



CÓDIGO	COMPONENTES	MEDIDA COMPONENTES	UDS X BOLSA	€/BOLSA	Nº MINIMO VENTA
EKMULROB	TN4S10	10 x 50 Ø10	4	7,740	12
	INVN7.070	7 x 70	4		
	BROCA GRATIS	10 x 120	1		

EKMACILU

Iluminación - Cuadros



MACIZOS



CÓDIGO	COMPONENTES	MEDIDA COMPONENTES	UDS X BOLSA	€/BOLSA	Nº MINIMO VENTA
EKMACILU	TN4S06	6 x 30 Ø6	4	5,103	12
	TPPOZ40.045	4 x 45	4		
	ALRO18.050	18x50 (3,7 x 37 x 15)	4		
	BROCA GRATIS	6 x 100	1		

EKHUEILU

Iluminación - Cuadros



HUECOS



CÓDIGO	COMPONENTES	MEDIDA COMPONENTES	UDS X BOLSA	€/BOLSA	Nº MINIMO VENTA
EKHUEILU	TAPLANY	15 x 33	4	5,103	12
	TPPOZ45.045	4,5 x 45	4		
	ALRO19.050	19x50 (4,4 x 37 x 15)	4		

EKMACFTP

Fijaciones techo pesadas



MACIZOS



CÓDIGO	COMPONENTES	MEDIDA COMPONENTES	UDS X BOLSA	€/BOLSA	Nº MINIMO VENTA
EKMACFTP	TN4S10	10 x 50 Ø10	4	7,394	12
	TB06.060	6 x 60	4		
	D12.506	M6	4		
	BROCA GRATIS	10 x 120	1		

EKHUEFTP

Cisternas WC



HUECOS



CÓDIGO	COMPONENTES	MEDIDA COMPONENTES	UDS X BOLSA	€/BOLSA	Nº MINIMO VENTA
EKHUEFTP	BAESM06	M6 Ø16	4	7,233	12

EKMACFTL

Fijaciones techo ligeras



MACIZOS



CÓDIGO	COMPONENTES	MEDIDA COMPONENTES	UDS X BOLSA	€/BOLSA	Nº MINIMO VENTA
EKMACFTL	TN4S06	6 x 30 Ø6	4	5,103	12
	TPPOZ40.040	4 x 40	4		
	BROCA GRATIS	6 x 100	1		

HUECOS



CÓDIGO	COMPONENTES	MEDIDA COMPONENTES	UDS X BOLSA	€/BOLSA	N° MINIMO VENTA
EKHUEFTL	BAESM04	M4 Ø14	2	5,103	12

EKHUEFTL

Fijaciones techo ligeras



MACIZOS



CÓDIGO	COMPONENTES	MEDIDA COMPONENTES	UDS X BOLSA	€/BOLSA	N° MINIMO VENTA
EKMACFTG	TN4S06	6 x 30 Ø6	4	5,103	12
	ALHA19.070	19x70 (4,4 x 41 x 15)	4		
	BROCA GRATIS	6 x 100	1		

EKMACFTG

Fijaciones techo pesadas



HUECOS



CÓDIGO	COMPONENTES	MEDIDA COMPONENTES	UDS X BOLSA	€/BOLSA	N° MINIMO VENTA
EKHUEFTG	BAGAM06	10 x 80 Ø10	2	5,103	12

EKHUEFTG

Fijaciones techo gancho



MULTIMATERIAL



CÓDIGO	COMPONENTES	MEDIDA COMPONENTES	UDS X BOLSA	€/BOLSA	N° MINIMO VENTA
EKMULFAP	TN4S08	8 x 40 Ø8	4	7,233	12
	TPPOZ05.050	5 x 50	4		
	ALRO19.050	19x50 (4,4 x 37 x 15)	4		
	BROCA GRATIS	8 x 120	1		

EKMULFAP

Fijaciones accesorios pesados



MULTIMATERIAL



CÓDIGO	COMPONENTES	MEDIDA COMPONENTES	UDS X BOLSA	€/BOLSA	N° MINIMO VENTA
EKMULFAL	TN4S05	5 x 25 Ø5	4	5,103	12
	TPPOZ35.030	3,5 x 30	4		
	ALRO17.040	17x40 (3,5 x 29 x 13)	4		
	BROCA GRATIS	5 x 85	1		

EKMULFAL

Pequeñas fijaciones





**GAMA
INOX**



MTP

Anclaje macho para cargas altas en hormigón fisurado y no fisurado

MTP-A4

Homologado ETE Opt.1. Eje Inoxidable A4. Clip Inoxidable A4



Util de colocación

02 Info. Técnica
P. 377

INOXIDABLE



CÓDIGO	MEDIDA	€/100	ESPOSOR MÁX. A FIJAR	LETRA EJE (LONGITUD)		
APA408075	M8 x 75 Ø8	317,357	9	C	100	600
APA408095	M8 x 95 Ø8	393,693	29	E	100	600
APA408115	M8 x 115 Ø8	445,824	49	G	100	400
APA408135	M8 x 135 Ø8	515,787	69	H	50	300
APA410090	M10 x 90 Ø10	529,971	10	E	100	400
APA410105	M10 x 105 Ø10	566,727	25	F	50	300
APA410115	M10 x 115 Ø10	624,312	35	G	50	300
APA410135	M10 x 135 Ø10	748,929	55	H	50	300
APA410165	M10 x 165 Ø10	893,658	85	K	50	100
APA410185	M10 x 185 Ø10	956,418	105	L	50	100
APA412110	M12 x 110 Ø12	769,476	14	F	50	200
APA412120	M12 x 120 Ø12	825,519	24	G	50	200
APA412130	M12 x 130 Ø12	896,412	34	H	50	200
APA412150	M12 x 150 Ø12	1.047,555	54	I	50	100
APA412180	M12 x 180 Ø12	1.221,933	84	L	50	150
APA412200	M12 x 200 Ø12	1.247,603	104	M	50	100
APA416125	M16 x 125 Ø16	1.704,563	8	G	50	100
APA416145	M16 x 145 Ø16	1.967,780	28	I	25	100
APA416175	M16 x 175 Ø16	2.577,187	58	K	25	50
APA416190	M16 x 190 Ø16	2.668,900	73	L	25	50
APA416220	M16 x 220 Ø16	2.842,630	103	O	20	40
APA420200	M20 x 200 Ø20	4.386,093	62	M	20	40
APA420240	M20 x 240 Ø20	5.034,167	102	P	15	30
APA420285	M20 x 285 Ø20	5.922,157	147	S	10	20

MTH

Anclaje macho para cargas altas en hormigón no fisurado

MTH-A2

Homologado ETE Opt.7. Eje Inoxidable A2. Clip Inoxidable A2



Util de colocación

02 Info. Técnica
P. 380

INOXIDABLE

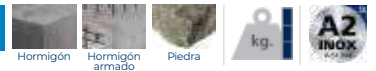

CÓDIGO	MEDIDA	€/100	ESPOSOR MÁX. A FIJAR	LETRA EJE (LONGITUD)		
• MIO6045	M6 x 45 Ø6	134,462	1	A	200	1.200
• MIO6060	M6 x 60 Ø6	150,793	2	B	200	1.200
• MIO6080	M6 x 80 Ø6	157,720	22	D	200	1.200
• MIO6120	M6 x 120 Ø6	194,797	62	G	100	600
• MIO6140	M6 x 140 Ø6	246,545	82	I	100	600
• MIO6160	M6 x 160 Ø6	267,436	102	J	100	400
• MIO6170	M6 x 170 Ø6	281,594	112	K	100	400
• MIO6180	M6 x 180 Ø6	325,706	122	L	100	300
• MIO8050	M8 x 50 Ø8	160,163	4	A	100	800
MIO8075	M8 x 75 Ø8	175,434	5	C	100	600
MIO8090	M8 x 90 Ø8	199,642	20	E	100	600
MIO8115	M8 x 115 Ø8	258,250	45	G	100	400
MI10070	M10 x 70 Ø10	271,445	3	C	100	400
MI10090	M10 x 90 Ø10	303,850	10	E	100	400
MI10120	M10 x 120 Ø10	356,142	40	G	50	300
MI10150	M10 x 150 Ø10	507,688	70	I	50	200
• MI12075	M12 x 75 Ø12	411,593	5	C	50	300
MI12090	M12 x 90 Ø12	427,093	13	D	50	200
MI12110	M12 x 110 Ø12	470,653	18	F	50	200
MI12140	M12 x 140 Ø12	589,905	48	I	50	200
• MI16090	M16 x 90 Ø16	1.136,670	4	D	25	150
MI16145	M16 x 145 Ø16	1.392,705	23	I	25	100
MI16170	M16 x 170 Ø16	1.576,915	48	K	25	75
• MI20120	M20 x 120 Ø20	1.807,833	5	G	20	40
MI20170	M20 x 170 Ø20	2.444,499	23	K	20	40
MI20220	M20 x 220 Ø20	3.062,988	73	O	20	40

• Medidas sin homologar
• Medida sin homologar para fuego

Blíster

CÓDIGO	MEDIDA	€/BOLSA	PCS	BOLSAS
BZMI08075	M8 x 75 Ø8	4,463	2	12
BZMI10090	M10 x 90 Ø10	4,463	2	10

Caja ventana

CÓDIGO	MEDIDA	€/CAJA	PCS	CAJAS
VMI08075	M8 x 75 Ø8	24,555	10	8
VMI08090	M8 x 90 Ø8	26,254	10	8
VMI10070	M10 x 70 Ø10	27,130	8	8
VMI10090	M10 x 90 Ø10	30,368	8	8
VMI10120	M10 x 120 Ø10	26,695	6	8
VMI12110	M12 x 110 Ø12	33,120	6	8

Bolsa autoservicio

CÓDIGO	MEDIDA	€/BOLSA	PCS	BOLSAS
LSMI08075	M8 x 75 Ø8	24,919	12	7
LSMI08090	M8 x 90 Ø8	28,358	12	7
LSMI10070	M10 x 70 Ø10	30,524	10	6
LSMI10090	M10 x 90 Ø10	30,368	8	6
LSMI10120	M10 x 120 Ø10	32,036	8	6
LSMI12110	M12 x 110 Ø12	33,120	6	6

Anclaje macho para cargas altas en hormigón no fisurado

MTH



02 Info
P. 380 Técnica

INOXIDABLE



MTH-A4

Homologado ETE Opt.7. Eje Inoxidable A4. Clip Inoxidable A4

CÓDIGO	MEDIDA	€/100	ESPESOR MÁX. A FIJAR	LETRA EJE (LONGITUD)		
• MIA406045	M6 x 45 Ø6	154,056	1	A	200	1.200
• MIA406060	M6 x 60 Ø6	167,836	2	B	200	1.200
• MIA406080	M6 x 80 Ø6	187,692	22	D	200	1.200
• MIA408050	M8 x 50 Ø8	197,184	4	A	100	800
MIA408075	M8 x 75 Ø8	218,704	5	C	100	600
MIA408090	M8 x 90 Ø8	238,853	20	E	100	600
MIA408115	M8 x 115 Ø8	300,139	45	G	100	400
MIA410070	M10 x 70 Ø10	342,939	3	C	100	400
MIA410090	M10 x 90 Ø10	388,704	10	E	100	400
MIA410120	M10 x 120 Ø10	472,506	40	G	50	300
MIA410150	M10 x 150 Ø10	691,956	70	I	50	200
• MIA412075	M12 x 75 Ø12	524,237	5	C	50	300
MIA412090	M12 x 90 Ø12	557,010	13	D	50	200
MIA412110	M12 x 110 Ø12	627,733	18	F	50	200
MIA412140	M12 x 140 Ø12	752,747	48	I	50	200
• MIA416090	M16 x 90 Ø16	1.391,103	4	D	25	150
MIA416145	M16 x 145 Ø16	1.827,627	23	I	25	100
MIA416170	M16 x 170 Ø16	2.110,490	48	K	25	75
• MIA420120	M20 x 120 Ø20	2.453,313	5	G	20	40
MIA420170	M20 x 170 Ø20	3.353,590	23	K	20	40
MIA420220	M20 x 220 Ø20	4.174,890	73	O	20	40

• Medidas sin homologar
• Medida sin homologar para fuego



Disponibles con arandela DIN 9021.
Consultar precio y plazo



Útil de colocación

 Caja ventana

CÓDIGO	MEDIDA	€/CAJA	PCS	CAJAS
VMIA408075	M8 x 75 Ø8	28,783	10	8
VMIA410090	M10 x 90 Ø10	39,392	8	8
VMIA412110	M12 x 110 Ø12	45,068	6	8

 Bolsa autoservicio



CÓDIGO	MEDIDA	€/BOLSA	PCS	BOLSAS
LSMIA408075	M8 x 75 Ø8	31,763	12	7
LSMIA410090	M10 x 90 Ø10	41,465	8	7
LSMIA412110	M12 x 110 Ø12	45,139	6	5

Útil de colocación para familia MT

DO-MT

MACIZOS



CÓDIGO	MEDIDA	€/PC		
DOMTA10	M6 - M8 - M10	10,302	5	225
DOMTA20	M12 - M14 - M16 - M20	17,171	5	225



TH/TF

Anclaje de fijación directa en hormigón

NEW TXE

Tornillo hormigón hexagonal con punta Bimetal. Inoxidable A4



MACIZOS



CÓDIGO	MEDIDA	€/100		ESPESOR MÁX. A FIJAR	
TXE06040	Ø6 x 40	224,863	10	5	100
TXE06060	Ø6 x 60	251,333	10	5	100
TXE08070	Ø8 x 70	362,343	13	5	50
TXE08080	Ø8 x 80	400,000	13	15	25
TXE08090	Ø8 x 90	450,000	13	25	25
TXE08105	Ø8 x 105	525,027	13	40	25
TXE10070	Ø10 x 70	441,697	15	15	50
TXE10090	Ø10 x 90	567,897	15	5	25
TXE10100	Ø10 x 100	609,187	15	15	25
TXE10120	Ø10 x 120	693,627	15	35	25
TXE12080	Ø12 x 80	659,273	18	5	25
TXE12110	Ø12 x 110	906,500	18	5	25

CH

Anclaje antigiro para cargas medias

CH-A2

Inoxidable A2. Homologado ETE Opt.7



02 Info. Técnica P. 387

INOXIDABLE

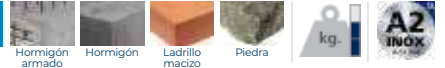

CÓDIGO	MEDIDA	€/100		
ACHTA208C	M6 x 45 Ø8	109,583	100	1.200
ACHTA208L	M6 x 60 Ø8	123,800	100	600
• ACHTA209C	M6 x 45 Ø9	124,010	100	1.200
• ACHTA209L	M6 x 60 Ø9	143,233	100	600
• ACHTA210C	M8 x 60 Ø10	177,550	100	600
ACHTA210L	M8 x 80 Ø10	204,243	100	400
• ACHTA211C	M8 x 60 Ø11	213,603	100	400
• ACHTA211L	M8 x 80 Ø11	251,620	100	400
ACHTA212C	M10 x 70 Ø12	299,513	100	200
ACHTA212L	M10 x 100 Ø12	366,293	50	200
• ACHTA214C	M10 x 70 Ø14	398,427	100	300
• ACHTA214L	M10 x 100 Ø14	444,400	50	200
ACHTA216C	M12 x 80 Ø16	590,597	50	100
ACHTA216L	M12 x 110 Ø16	747,340	50	100
ACHTA220C	M16 x 110 Ø20	1.534,333	25	75

• Medidas sin homologar

Blíster

CÓDIGO	MEDIDA	€/BOLSA	PCS	BOLSAS
BZACHTA208C	M6 x 45 Ø8	4,463	2	15
BZACHTA208L	M6 x 60 Ø8	4,463	2	15
BZACHTA210C	M8 x 60 Ø10	4,463	2	15
BZACHTA210L	M8 x 80 Ø10	4,463	2	15

Caja ventana

CÓDIGO	MEDIDA	€/CAJA	PCS	CAJAS
VACHTA208C	M6 x 45 Ø8	12,948	10	8
VACHTA208L	M6 x 60 Ø8	15,055	10	8
VACHTA210C	M8 x 60 Ø10	13,481	6	8
VACHTA210L	M8 x 80 Ø10	16,052	6	8
VACHTA212C	M10 x 70 Ø12	15,128	4	8
VACHTA212L	M10 x 100 Ø12	18,672	4	8

Bolsa autoservicio

CÓDIGO	MEDIDA	€/BOLSA	PCS	BOLSAS
LSACHTA208C	M6 x 45 Ø8	13,985	12	6
LSACHTA208L	M6 x 60 Ø8	16,258	12	6
LSACHTA210C	M8 x 60 Ø10	16,179	8	6
LSACHTA210L	M8 x 80 Ø10	19,262	8	6
LSACHTA212C	M10 x 70 Ø12	20,427	6	6
LSACHTA212L	M10 x 100 Ø12	18,672	4	5

CH-PI

Cabeza plana inoxidable A2. Homologado ETE Opt.7



02 Info. Técnica P. 388

INOXIDABLE

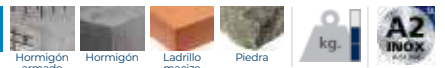

CÓDIGO	MEDIDA	€/100		
ACHTPI08C	M6 x 45 Ø8	113,997	4	100
ACHTPI08L	M6 x 60 Ø8	145,963	4	100
ACHTPI10C	M8 x 60 Ø10	215,057	5	100
ACHTPI10L	M8 x 80 Ø10	254,583	5	100
ACHTPI12C	M10 x 70 Ø12	340,053	6	50
ACHTPI12L	M10 x 100 Ø12	401,477	6	50

Anclaje antigiro para cargas medias

CH

02 Info
Técnica
p. 389

INOXIDABLE



CÓDIGO	MEDIDA	€/100	APERTURA GANCHO		
ACHGA208C	M6 x 45 Ø8	447,373	10	100	600
ACHGA210C	M8 x 60 Ø10	664,537	11	100	400
ACHGA212C	M10 x 70 Ø12	881,316	14	50	200

CH-GF A2

Gancho forjado. Inoxidable A2



02 Info
Técnica
p. 389

INOXIDABLE



CÓDIGO	MEDIDA	€/100	Ø OJO		
ACHAA208C	M6 x 45 Ø8	491,243	10	100	600
ACHAA210C	M8 x 60 Ø10	783,613	11	100	400
ACHAA212C	M10 x 70 Ø12	1.045,200	14	50	200

CH-AF A2

Argolla forjada. Inoxidable A2





Anclaje hembra con cono interior para grandes cargas

HE

02 Info
Técnica
p. 390

INOXIDABLE



CÓDIGO	MEDIDA	€/100	LONGITUD		
HEA4M06	M6 x 25 Ø8	108,158	25	100	4.000
HEA4M08	M8 x 30 Ø10	154,220	30	100	1.600
HEA4M10	M10 x 40 Ø12	243,967	40	50	800
HEA4M12	M12 x 50 Ø15	461,453	50	50	600
HEA4M16	M16 x 65 Ø20	979,605	65	25	250
HEA4M20	M20 x 80 Ø25	1.784,273	80	25	100

HE-A4



Inoxidable A4. Homologado ETE
Aplicaciones no estructurales



02 Info
Técnica
p. 390

INOXIDABLE



CÓDIGO	MEDIDA	€/100	LONGITUD		
HEC4M06	M6 x 25 Ø8	141,623	25	100	3.200
HEC4M08	M8 x 30 Ø10	202,781	30	100	1.600
HEC4M10	M10 x 40 Ø12	313,291	40	50	800
HEC4M12	M12 x 50 Ø15	563,284	50	50	400

HE-C4

Con collarín. Inoxidable A4.
Homologado ETE Aplicaciones no
estructurales



AC

Anclaje de acero con aletas para cargas altas

AC-CI

Cápsula. Inoxidable A4



02 Info. Técnica
P. 393

INOXIDABLE

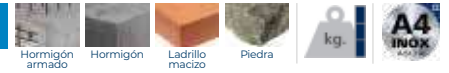

CÓDIGO	MEDIDA	€/100	LONGITUD CÁPSULA		
AACCI06	M6 x 40 Ø10	427,496	40	50	1.200
AACCI08	M8 x 50 Ø14	775,140	50	50	600
AACCI10	M10 x 60 Ø16	895,663	60	25	300
AACCI12	M12 x 80 Ø20	1.604,667	80	10	120

HI

Anclaje antigiro para cargas altas

HI-CI

Cápsula. Inoxidable A2



02 Info. Técnica
P. 394

INOXIDABLE

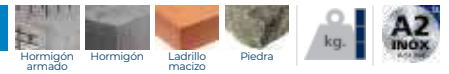

CÓDIGO	MEDIDA	€/100	LONGITUD CÁPSULA		
AHICI0645	M6 x 45 Ø12	600,257	45	100	600
AHICI0855	M8 x 55 Ø14	800,887	55	50	600
AHICI1065	M10 x 65 Ø16	1.069,243	65	50	300

AV

Anclaje para fachadas ventiladas

AVR

Roscado



INOXIDABLE



CÓDIGO	MEDIDA	€/100		
AVR08120	M8 x 120 Ø8	319,140	100	600
AVR08150	M8 x 150 Ø8	353,937	100	600
AVR10120	M10 x 120 Ø10	399,093	100	400
AVR10150	M10 x 150 Ø10	456,713	100	200
AVR10180	M10 x 180 Ø10	508,140	100	200

AVC

Corrugado



INOXIDABLE

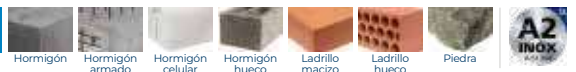





CÓDIGO	MEDIDA	€/100		
AVC08120	8 x 120 Ø8	403,750	100	400
AVC08150	8 x 150 Ø8	460,750	100	-
AVC10120	10 x 120 Ø10	566,103	100	400
AVC10150	10 x 150 Ø10	648,407	100	200
AVC10180	10 x 180 Ø10	732,023	100	200

Espárragos con tuerca y arandela para anclaje químico

EQ

QUÍMICOS



CÓDIGO	MEDIDA	€/100			CÓDIGO	MEDIDA	€/100		
EQA208110	M8 x 110	266,243	10	240	EQA220260	M20 x 260	3.039,723	6	12
EQA210130	M10 x 130	463,153	10	120	EQA224300	M24 x 300	4.857,647	6	12
EQA212160	M12 x 160	767,590	10	120	EQA230330	M30 x 330	8.153,597	6	12
EQA216190	M16 x 190	1.590,427	10	40					





EQ-A2

Inoxidable A2



QUÍMICOS



CÓDIGO	MEDIDA	€/100			CÓDIGO	MEDIDA	€/100		
EQA408110	M8 x 110	338,743	10	240	EQA420260	M20 x 260	5.048,270	6	12
EQA410130	M10 x 130	615,293	10	120	EQA424300	M24 x 300	8.320,540	6	12
EQA412160	M12 x 160	1.058,413	10	120	EQA430330	M30 x 330	14.677,490	6	12
EQA416190	M16 x 190	2.073,420	10	40					

EQ-A4

Inoxidable A4



Taco de nylon universal de alto rendimiento

T-NUX

02 P. 400 Info. Técnica

INOXIDABLE

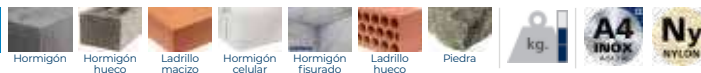

CÓDIGO	MEDIDA	€/100		ESPESOR MÁX. A FIJAR		
• TNXA408080	8 x 80 Ø8	269,183	TX30	10	50	600
• TNXA408100	8 x 100 Ø8	324,590	TX30	30	50	600
• TNXA408120	8 x 120 Ø8	400,986	TX30	50	50	300
TNXA410080	10 x 80 Ø10	342,621	TX40	10	50	300
TNXA410100	10 x 100 Ø10	409,076	TX40	30	50	300
TNXA410120	10 x 120 Ø10	476,397	TX40	50	50	300
TNXA410140	10 x 140 Ø10	564,921	TX40	70	50	300

• Medida sin homologar para fuego

T-NUX A A4

Inoxidable A4. Cabeza avellanada. Huella TX. Homologado ETE



02 P. 400 Info. Técnica

INOXIDABLE

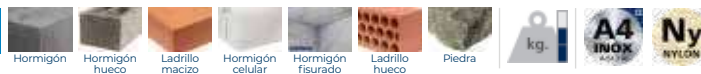

CÓDIGO	MEDIDA	€/100	Nº HUELLA	ESPESOR MÁX. A FIJAR		
• TNXE408080	8 x 80 Ø8	377,869	SW10/TX30	10	50	600
• TNXE408100	8 x 100 Ø8	447,874	SW10/TX30	30	50	300
TNXE410080	10 x 80 Ø10	501,207	SW13/TX40	10	50	300
TNXE410100	10 x 100 Ø10	523,441	SW13/TX40	30	50	300
TNXE410120	10 x 120 Ø10	629,179	SW13/TX40	50	50	300
TNXE410140	10 x 140 Ø10	733,938	SW13/TX40	70	50	200

• Medida sin homologar para fuego

T-NUX E A4

Inoxidable A4. Cabeza hexagonal. Huella TX. Homologado ETE



TC

Taco clavable de poliamida 6.6, premontado con tornillo rosca-arpón

TC-A2

Taco con cabeza avellanada y tornillo inoxidable A2



INOXIDABLE



CÓDIGO	MEDIDA	€/100		ESPESOR MÁX. A FIJAR		
TCA205030	5 x 30 Ø5	43,177	PZ2	5	100	2.400
TCA206040	6 x 40 Ø6	56,177	PZ2	10	100	1.200
TCA206060	6 x 60 Ø6	80,370	PZ2	30	100	1.200
TCA208060	8 x 60 Ø8	126,493	PZ3	20	100	600
TCA208080	8 x 80 Ø8	148,397	PZ3	40	100	600
TCA208100	8 x 100 Ø8	195,183	PZ3	60	100	600

RE

Remaches

RE-IN

Cabeza alomada. Acero inoxidable A2



METAL



CÓDIGO	MEDIDA	€/100	Ø BROCA	ESPESOR MÁX. A FIJAR		
REIN3206	3,2 x 6,4	15,697	3,3	0,5 - 3	500	6.000
REIN3208	3,2 x 8	16,793	3,3	3 - 5	500	6.000
REIN3212	3,2 x 12,7	24,747	3,3	6,5 - 8,5	500	6.000
REIN3215	3,2 x 15,9	29,900	3,3	10,5 - 12,5	500	6.000
REIN4008	4 x 8,5	28,190	4,1	2,5 - 4,5	500	6.000
REIN4010	4 x 10,2	29,997	4,1	4,5 - 6,5	500	6.000
REIN4012	4 x 12	33,997	4,1	6,5 - 8,5	500	6.000
REIN4016	4 x 16	41,163	4,1	10 - 12	500	3.000
REIN4810	4,8 x 10,8	41,473	5	4 - 6	500	3.000
REIN4812	4,8 x 12	45,333	5	6 - 8	500	3.000
REIN4816	4,8 x 16	55,733	5	8 - 11	250	3.000
REIN4820	4,8 x 20,3	78,197	5	11 - 13	250	3.000
REIN4818	4,8 x 18	59,590	5	13 - 15	250	3.000

SJ

Sujetacable DIN 741

NEW SJ-A4

Inoxidable A4



METAL



CÓDIGO	MÉTRICA	Ø CABLE	€/100		
SJA42103	M4	M4(Ø3)	195,100	50	1.200
SJA42305	M5	M5(Ø5)	257,000	40	960
SJA42606	M5	M5(Ø6)	280,800	20	900
SJA43008	M6	M6(Ø8)	295,100	20	480
SJA43410	M8	M8(Ø10)	523,500	10	240
SJA43611	M8	M8(Ø11)	761,500	10	240
SJA44414	M10	M10(Ø14)	894,800	5	225
SJA45016	M12	M12(Ø16)	1.423,000	5	120
SJA45418	M12	M12(Ø18)	2.141,700	5	80
SJA46122	M14	M14(Ø22)	3.036,500	1	45
SJA46525	M14	M14(Ø25)	3.402,900	1	24

SJ-P

Sujetacable plano

NEW SJ-PS A4

Simple. Inoxidable A4



METAL

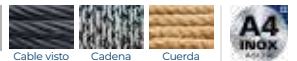

CÓDIGO	MÉTRICA	Ø CABLE	€/100		
SJPSA40403	M4	M4(Ø3)	99,947	30	1.350
SJPSA40504	M5	M5(Ø4)	147,540	30	1.350
SJPSA40605	M6	M6(Ø5)	204,650	20	900
SJPSA40606	M6	M6(Ø6)	347,430	10	450

Sujetacable plano

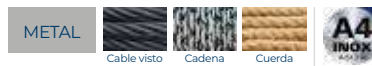

SJ-P



SJ-PD A4 NEW

Doble. Inoxidable A4



CÓDIGO	MÉTRICA	Ø CABLE	€/100		
SJPDA40403	M4	M4(Ø3)	166,577	30	720
SJPDA40504	M5	M5(Ø4)	271,283	30	720
SJPDA40605	M5	M5(Ø5)	337,913	20	480
SJPDA40606	M6	M6(Ø6)	585,397	10	240

Tensor gancho/anilla DIN-1480

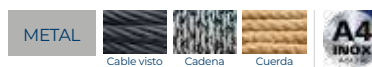

TS-GA



TS-GA A4 NEW

Inoxidable A4



CÓDIGO	MÉTRICA	Ø CABLE	€/100		
TSGAA405	M5	M5(Ø8)	493,900	10	240
TSGAA406	M6	M6(Ø10)	692,500	10	120
TSGAA410	M10	M10(Ø14)	1.800,400	5	30
TSGAA412	M12	M12(Ø17)	3.393,200	5	30

Tensor anilla/anilla DIN-1480

TS-AA

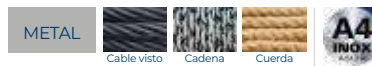

TS-AA A4 NEW

Inoxidable A4



CÓDIGO	MÉTRICA	Ø CABLE	€/100		
TSAAA410	M10	M10(Ø14)	1.856,100	5	20
TSAAA412	M12	M12(Ø17)	3.498,100	5	20
TSAAA405	M5	M5(Ø8)	509,200	10	240
TSAAA406	M6	M6(Ø10)	713,900	10	120
TSAAA408	M8	M8(Ø11)	1.251,700	10	60

Tensor gancho/gancho DIN-1480

TS-GG

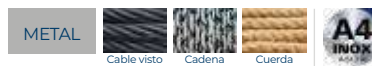

TS-GG A4 NEW

Inoxidable A4



CÓDIGO	MÉTRICA	Ø CABLE	€/100		
TSGGA405	M5	M5(Ø7)	509,200	10	240
TSGGA406	M6	M6(Ø8)	713,900	10	120
TSGGA408	M8	M8(Ø9.5)	1.251,700	10	-
TSGGA410	M10	M10(Ø12)	1.856,100	5	20
TSGGA412	M12	M12(Ø15)	3.498,100	5	15

EV-H

Cáncamo hembra D-582

NEW EV-H A4

Inoxidable A4



CÓDIGO	MÉTRICA	Ø CABLE	€/100		
EVHA406	M6	M6(Ø15)	209,410	10	450
EVHA408	M8	M8(Ø20)	337,913	10	450
EVHA410	M10	M10(Ø25)	642,510	10	240
EVHA412	M12	M12(Ø30)	951,867	5	120
EVHA414	M14	M14(Ø30)	1.427,800	5	120
EVHA416	M16	M16(Ø35)	1.665,767	1	-
EVHA420	M20	M20(Ø38)	2.189,293	1	-
EVHA424	M24	M24(Ø50)	4.759,333	1	24

EV-M

Cáncamo macho D-580

NEW EV-M A4

Inoxidable A4

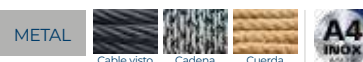

CÓDIGO	MÉTRICA	Ø CABLE	€/100		
EVMA406	M6	M6 (Ø20)	223,690	10	450
EVMA408	M8	M8 (Ø20)	385,507	10	450
EVMA410	M10	M10 (Ø25)	690,103	10	240
EVMA412	M12	M12(Ø30)	1.047,053	5	120
EVMA414	M14	M14 (Ø35)	1.546,783	5	120
EVMA416	M16	M16 (Ø35)	1.808,547	1	45
EVMA420	M20	M20 (Ø40)	2.617,633	1	-
EVMA424	M24	M24(Ø50)	5.711,200	1	12

GR

Grillete recto

NEW GR-A4

Inoxidable A4

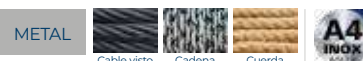

CÓDIGO	MÉTRICA	Ø CABLE	€/100		
GRA404	M4	M4(Ø8)	209,410	25	1.125
GRA405	M5	M5(Ø10)	228,447	25	1.125
GRA406	M6	M6(Ø12)	261,763	25	600
GRA408	M8	M8(Ø16)	390,267	10	240
GRA410	M10	M10(Ø19)	628,233	10	120
GRA412	M12	M12(Ø25)	989,940	5	60
GRA414	M14	M14(Ø28)	1.594,377	5	60
GRA416	M16	M16(Ø32)	2.284,480	5	40
GRA419	M20	M20(Ø38)	4.473,773	1	-
GRA425	M25	M25(Ø50)	9.613,853	1	-

GD

Guardacabo DIN-6899/A

NEW GD-A4

Inoxidable A4

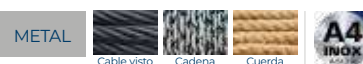

CÓDIGO	MÉTRICA	Ø CABLE	€/100		
GDA402	M2	M2(Ø10)	39,503	100	4.500
GDA403	M3	M3(Ø12)	57,113	100	4.500
GDA404	M4	M4(Ø13)	66,630	50	2.250
GDA405	M5	M5(Ø14)	90,427	50	1.200
GDA406	M6	M6(Ø15)	104,707	50	1.200
GDA408	M8	M8(Ø18)	199,893	50	600
GDA410	M10	M10(Ø22)	328,393	25	300
GDA412	M12	M12(Ø26)	385,507	10	120
GDA415	M15	M15(Ø32)	666,307	5	60

Grillete lira

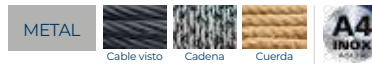

GI



GI-A4 **NEW**

Inoxidable A4



CÓDIGO	MÉTRICA	Ø CABLE	€/100		
GIA404	M4	M4(Ø6)	266,523	25	1.125
GIA405	M5	M5(Ø8)	290,320	25	1.125
GIA406	M6	M6(Ø10)	318,877	10	450
GIA408	M8	M8(Ø12)	475,933	10	240
GIA410	M10	M10(Ø16)	785,290	10	120
GIA412	M12	M12(Ø28)	1.237,427	5	60
GIA414	M14	M14(Ø33)	2.141,700	5	60
GIA416	M16	M16(Ø37)	2.926,990	5	30

Tornillo autotaladrante de cabeza hexagonal



DIN-7504-K



DIN-7504-K A2

Tornillo. Inoxidable A2



CÓDIGO	MEDIDA	€/100			
ABEI4213	4,2 x 13	16,923	7	1.000	12.000
ABEI4216	4,2 x 16	18,987	7	1.000	8.000
ABEI4219	4,2 x 19	19,680	7	1.000	8.000
ABEI4813	4,8 x 13	23,940	8	1.000	8.000
ABEI4816	4,8 x 16	23,393	8	500	6.000
ABEI4819	4,8 x 19	25,313	8	500	6.000
ABEI4825	4,8 x 25	28,347	8	500	6.000
ABEI4832	4,8 x 32	33,703	8	500	3.000
ABEI5519	5,5 x 19	34,947	8	500	6.000
ABEI5522	5,5 x 22	37,283	8	500	4.000
ABEI5525	5,5 x 25	39,623	8	500	6.000
ABEI6319	6,3 x 19	52,967	10	500	3.000
ABEI6325	6,3 x 25	60,260	10	500	3.000

Tornillo autotaladrante inoxidable bimetálico con cabeza hexagonal

ABE BIMETAL



ABE BIMETAL

Tornillo



CÓDIGO	MEDIDA	€/100		ESPESOR MÁX. A FIJAR	CAPACIDAD DE TALADRADO		
BIE4825	4,8 x 25	69,316	8	9	1,75-4,40	500	6.000
BIE5525	5,5 x 25	81,254	8	5	1,75-5,25	500	6.000
BIE5532	5,5 x 32	93,313	8	12	1,75-5,25	500	3.000
BIE5538	5,5 x 38	99,214	8	18	1,75-5,25	500	3.000
BIE5550	5,5 x 50	114,514	8	30	1,75-5,25	500	2.000
BIE5558	5,5 x 58	127,455	8	38	1,75-5,25	250	1.500
BIE5565	5,5 x 65	133,217	8	45	1,75-5,25	250	1.500
BIE5580	5,5 x 80	157,168	8	60	1,75-5,25	250	1.000
BIE6325	6,3 x 25	104,045	10	7	2,50-6,00	500	3.000



ABE BIMETAL + ARVUL

Tornillo con arandela vulcanizada de acero-EPDM



CÓDIGO	MEDIDA	€/100		ESPESOR MÁX. A FIJAR	CAPACIDAD DE TALADRADO		
BIE164825	4,8 x 25 P16	83,140	8	7	1,75-4,40	500	2.000
BIE165525	5,5 x 25 P16	96,319	8	3	1,75-5,25	500	2.000
BIE165532	5,5 x 32 P16	109,581	8	10	1,75-5,25	500	2.000
BIE165538	5,5 x 38 P16	115,253	8	16	1,75-5,25	500	1.500
BIE165550	5,5 x 50 P16	134,429	8	28	1,75-5,25	500	1.500
BIE165558	5,5 x 58 P16	144,635	8	36	1,75-5,25	250	1.500
BIE165565	5,5 x 65 P16	150,525	8	43	1,75-5,25	250	1.500
BIE165580	5,5 x 80 P16	175,166	8	58	1,75-5,25	250	1.000
BIE166325	6,3 x 25 P16	120,333	10	5	2,50-6,00	500	2.000

AUTO BIMETAL

Tornillo viga autotaladrante inoxidable bimetetal con cabeza hexagonal

AUTO BIMETAL

Tornillo

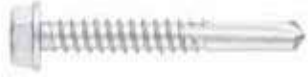

CÓDIGO	MEDIDA	€/100		ESPEJOR MÁX. A FIJAR	CAPACIDAD DE TALADRADO		
BAUTO5540	5,5 x 40	121,031	8	10	4,00-12,00	500	3.000
BAUTO5550	5,5 x 50	168,200	8	20	4,00-12,00	500	3.000
BAUTO5565	5,5 x 65	175,713	8	35	4,00-12,00	250	1.500
BAUTO5580	5,5 x 80	220,863	8	50	4,00-12,00	250	1.000
BAUTO5510	5,5 x 100	223,343	8	70	4,00-12,00	100	600

AUTO BIMETAL + ARVUL

Tornillo con arandela vulcanizada de acero-EPDM



CÓDIGO	MEDIDA	€/100		ESPEJOR MÁX. A FIJAR	CAPACIDAD DE TALADRADO		
BAUTO165540	5,5 x 40 P16	143,457	8	8	4,00-12,00	500	1.500
BAUTO165550	5,5 x 50 P16	193,930	8	18	4,00-12,00	500	1.500
BAUTO165565	5,5 x 65 P16	200,373	8	33	4,00-12,00	250	1.500
BAUTO165580	5,5 x 80 P16	235,510	8	48	4,00-12,00	250	1.000
BAUTO165510	5,5 x 100 P16	248,297	8	68	4,00-12,00	100	600

PS

Tornillo autotaladrante de cabeza hexagonal para panel sándwich

PS 3 + ARVUL A2

Punta broca estándar #3 con recubrimiento ATLANTIS C4-M y arandela inoxidable A2



CÓDIGO	MEDIDA	€/100		ESPEJOR MÁX. A FIJAR	CAPACIDAD DE TALADRADO		
PS1955195	5,5 / 6,3 x 195 P19	271,965	8	130 - 185	1,50-6,00	200	400
PS1955230	5,5 / 6,3 x 230 P19	362,090	8	166 - 215	1,50-6,00	200	-

PS 5 + ARVUL A2

Punta broca extra larga #5 con recubrimiento ATLANTIS C4-M y arandela inoxidable A2



CÓDIGO	MEDIDA	€/100		ESPEJOR MÁX. A FIJAR	CAPACIDAD DE TALADRADO		
PSL1955255	5,5 / 6,3 x 255 P19	504,267	8	170 - 210	6,00-12,00		200
PSL1955285	5,5 / 6,3 x 285 P19	829,807	8	200 - 250	6,00-12,00		200

ARVUL

Arandela vulcanizada de acero-EPDM

ARVUL A2

Inoxidable A2



CÓDIGO	MEDIDA	€/100		Ø INTERIOR ARANDELA		
ARINO14	P14	11,587		2.5	1.000	12.000
ARINO16	P16	13,100		2.7	1.000	6.000
ARINO18	P18	16,485		3.2	1.000	6.000
ARINO25	P25	30,483		3.3	500	3.000
ARINOM30	P30	48,630		6.3	500	1.500

Arandela paraguas

ARPAR

METAL



ARPAR A2 ^{NEW}

Inoxidable A2



CÓDIGO	MEDIDA	€/100		
ARPARA225	P22	41,150	250	1.500

Tornillo autotaladrante de cabeza alomada

DIN-7504-N



INOXIDABLE



DIN-7504-N HP A2

Inoxidable A2. Huella PH



CÓDIGO	MEDIDA	€/100		ESPESOR MÁX. A FIJAR	CAPACIDAD DE TALADRADO		
ABRA23509	3,5 x 9,5	11,517	PH2	2,85	0,70-2,25	1.000	24.000
ABRA23513	3,5 x 13	13,643	PH2	6,2	0,70-2,25	500	12.000
ABRA23519	3,5 x 19	16,717	PH2	12,1	0,70-2,25	500	12.000
ABRA24213	4,2 x 13	15,980	PH2	4,3	1,75-3,00	500	12.000
ABRA24216	4,2 x 16	17,900	PH2	7,3	1,75-3,00	500	12.000
ABRA24219	4,2 x 19	19,050	PH2	10,3	1,75-3,00	500	12.000
ABRA24225	4,2 x 25	20,750	PH2	16,3	1,75-3,00	250	6.000
ABRA24816	4,8 x 16	25,067	PH2	5,5	1,75-4,40	250	6.000
ABRA24819	4,8 x 19	25,467	PH2	8,7	1,75-4,40	250	6.000
ABRA24825	4,8 x 25	28,293	PH2	14,7	1,75-4,40	250	6.000
ABRA24832	4,8 x 32	33,117	PH2	21,5	1,75-4,40	250	4.000
ABRA24838	4,8 x 38	36,257	PH2	27,5	1,75-4,40	250	3.000
ABRA24850	4,8 x 50	42,750	PH2	39,5	1,75-4,40	250	3.000

Tornillo punta broca, cabeza remache y huella PH

RS



INOXIDABLE



RS-A2

Inoxidable A2



CÓDIGO	MEDIDA	€/100		ESPESOR MÁX. A FIJAR	CAPACIDAD DE TALADRADO		
RSA23509	3,5 x 9,5	14,270	PH2	2,8	0,75 - 2,25	500	22.500
RSA24213	4,2 x 13	20,557	PH2	7,3	1,75 - 3	500	22.500
RSA24216	4,2 x 16	21,897	PH2	10,3	1,75 - 3	500	12.000
RSA24219	4,2 x 19	23,220	PH2	16,3	1,75 - 3	500	12.000
RSA24816	4,8 x 16	28,733	PH2	5,5	1,75 - 4,4	250	11.250
RSA24819	4,8 x 19	30,790	PH2	8,7	1,75 - 4,4	250	11.250
RSA24825	4,8 x 25	34,737	PH2	14,7	1,75 - 4,4	250	6.000

Tornillo autotaladrante de cabeza extraplana y huella PH

BCP

INOXIDABLE



BCP A2

Inoxidable A2. Huella PH



CÓDIGO	MEDIDA	€/100		ESPESOR MÁX. A FIJAR	CAPACIDAD DE TALADRADO		
BCPA24214	4,2 x 14	21,853	PH2	6	0,70-2,00	500	12.000
BCPA24223	4,2 x 23	30,160	PH2	6	-	500	12.000

CP

Tornillo rosca chapa con cabeza extraplana

CP-A2

Inoxidable A2. Huella PH

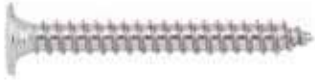

INOXIDABLE



CÓDIGO	MEDIDA	€/100		ESPESOR MÁX. A FIJAR		
TCPA24213	4,2 x 13	9,320	PH2	6	500	12.000
TCPA24222	4,2 x 22	16,507	PH2	15	500	12.000
TCPA24232	4,2 x 32	20,137	PH2	25	500	6.000

TEX

Tirafondo de alto rendimiento

TEX-A2

Inoxidable A2. Huella TX



INOXIDABLE



CÓDIGO	MEDIDA	€/100			
TEXA250050	5 x 50	30,953	TX25	250	3.000
TEXA250060	5 x 60	37,197	TX25	100	2.400
TEXA250070	5 x 70	42,157	TX25	100	2.400

Blíster

CÓDIGO	MEDIDA	€/BOLSA	PCS	BOLSAS
BZTXA250050	5 x 50	2,459	4	20
BZTXA250060	5 x 60	2,459	4	20
BZTXA250070	5 x 70	2,459	2	20

Caja ventana

CÓDIGO	MEDIDA	€/CAJA	PCS	CAJAS
VTEXA250050	5 x 50	7,967	20	8
VTEXA250060	5 x 60	9,570	20	8
VTEXA250070	5 x 70	10,853	20	8



TP

Tirafondos de cabeza avellanada

TP-A2

Inoxidable A2. Huella PZ



INOXIDABLE





CÓDIGO	MEDIDA	€/100			
TPA230016	3 x 16	4,810	PZ1	200	9.000
TPA230025	3 x 25	6,150	PZ1	200	9.000
TPA235020	3,5 x 20	8,290	PZ2	200	9.000
TPA235025	3,5 x 25	8,957	PZ2	200	9.000
TPA235030	3,5 x 30	10,920	PZ2	200	9.000
TPA235040	3,5 x 40	15,527	PZ2	200	4.800
TPA240030	4 x 30	13,273	PZ2	200	4.800
TPA240040	4 x 40	15,673	PZ2	200	4.800
TPA240050	4 x 50	24,597	PZ2	200	4.800
TPA245030	4,5 x 30	15,587	PZ2	200	4.800
TPA245050	4,5 x 50	24,897	PZ2	200	2.400
TPA250050	5 x 50	31,400	PZ2	200	2.400
TPA250070	5 x 70	42,793	PZ2	200	2.400

Tornillo con rosca para madera y aglomerado. Cabeza hexagonal

DIN-571

INOXIDABLE



CÓDIGO	MEDIDA	€/100			
• TBA206040	6 x 40	32,353	10	100	2.400
• TBA206050	6 x 50	39,317	10	100	1.200
• TBA206060	6 x 60	47,063	10	100	1.200
• TBA206070	6 x 70	50,543	10	100	1.200
• TBA208050	8 x 50	73,330	13	100	1.200
• TBA208060	8 x 60	84,123	13	100	1.200
• TBA208070	8 x 70	97,087	13	100	600
• TBA208080	8 x 80	103,980	13	100	600
• TBA210080	10 x 80	181,847	17	100	400

• Medidas sin homologar

DIN-571 A2

Inoxidable A2





Tornillo inviolable. Huella TX

INV

INOXIDABLE



CÓDIGO	MEDIDA	€/100			
• INVVA27050	7 x 50	114,159	TX40	100	1.200
• INVVA27060	7 x 60	135,247	TX40	100	600
• INVVA27070	7 x 70	150,110	TX40	100	600
• INVVA27080	7 x 80	162,043	TX40	100	600

• Medidas sin homologar

INV A2

Inoxidable A2



DIN-933

Tornillo rosca métrica con cabeza hexagonal 8.8. Rosca completa

DIN-933 A2

INOXIDABLE



Inoxidable A2

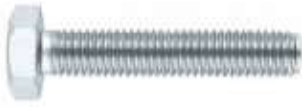

CÓDIGO	MEDIDA	€/100				CÓDIGO	MEDIDA	€/100			
D933IM04010	M4 x 10	10,103	7	500	12.000	D933IM10040	M10 x 40	96,259	17	200	-
D933IM04016	M4 x 16	12,100	7	500	12.000	D933IM10050	M10 x 50	111,160	17	200	-
D933IM04020	M4 x 20	13,920	7	500	8.000	D933IM10060	M10 x 60	127,297	17	100	600
D933IM04025	M4 x 25	15,017	7	500	8.000	D933IM10070	M10 x 70	143,590	17	100	400
D933IM04030	M4 x 30	17,590	7	500	6.000	D933IM10080	M10 x 80	168,953	17	100	400
D933IM04035	M4 x 35	21,110	7	250	6.000	D933IM10090	M10 x 90	190,347	17	50	300
D933IM04040	M4 x 40	23,470	7	250	6.000	D933IM10100	M10 x 100	214,773	17	50	300
D933IM05010	M5 x 10	10,553	8	500	8.000	D933IM12020	M12 x 20	115,770	19	100	600
D933IM05016	M5 x 16	12,373	8	500	-	D933IM12030	M12 x 30	120,420	19	100	600
D933IM05020	M5 x 20	14,013	8	500	6.000	D933IM12040	M12 x 40	139,996	19	100	400
D933IM05025	M5 x 25	16,614	8	500	4.000	D933IM12050	M12 x 50	161,560	19	100	400
D933IM05030	M5 x 30	19,241	8	500	4.000	D933IM12060	M12 x 60	184,142	19	100	400
D933IM05035	M5 x 35	20,657	8	250	3.000	D933IM12070	M12 x 70	206,963	19	100	-
D933IM05040	M5 x 40	23,203	8	250	3.000	D933IM12080	M12 x 80	250,677	19	50	300
D933IM05050	M5 x 50	28,393	8	250	3.000	D933IM12090	M12 x 90	274,450	19	50	300
D933IM06010	M6 x 10	17,703	10	250	6.000	D933IM12100	M12 x 100	298,230	19	25	150
D933IM06016	M6 x 16	18,757	10	250	4.000	D933IM14030	M14 x 30	226,913	22	50	300
D933IM06020	M6 x 20	21,730	10	250	4.000	D933IM14040	M14 x 40	248,520	22	50	300
D933IM06025	M6 x 25	22,580	10	250	3.000	D933IM14050	M14 x 50	283,100	22	50	300
D933IM06030	M6 x 30	26,233	10	250	3.000	D933IM14060	M14 x 60	321,997	22	50	200
D933IM06035	M6 x 35	29,667	10	250	2.000	D933IM14070	M14 x 70	358,733	22	50	200
D933IM06040	M6 x 40	32,790	10	250	2.000	D933IM14080	M14 x 80	385,333	22	25	150
D933IM06050	M6 x 50	38,913	10	250	1.500	D933IM14100	M14 x 100	528,510	22	25	150
D933IM08016	M8 x 16	34,613	13	200	1.600	D933IM16030	M16 x 30	250,570	24	50	300
D933IM08020	M8 x 20	37,520	13	200	1.600	D933IM16040	M16 x 40	266,063	24	50	200
D933IM08025	M8 x 25	42,353	13	200	1.600	D933IM16050	M16 x 50	306,067	24	50	200
D933IM08030	M8 x 30	47,090	13	200	1.200	D933IM16060	M16 x 60	348,204	24	50	200
D933IM08035	M8 x 35	51,813	13	200	1.200	D933IM16070	M16 x 70	388,122	24	25	150
D933IM08040	M8 x 40	57,193	13	200	1.200	D933IM16080	M16 x 80	444,530	24	25	150
D933IM08050	M8 x 50	68,820	13	200	800	D933IM16090	M16 x 90	492,203	24	25	150
D933IM08060	M8 x 60	78,547	13	200	800	D933IM16100	M16 x 100	533,173	24	25	100
D933IM08070	M8 x 70	94,123	13	200	800	D933IM18030	M18 x 30	500,940	27	25	100
D933IM08080	M8 x 80	107,577	13	100	600	D933IM18040	M18 x 40	529,820	27	25	200
D933IM08090	M8 x 90	119,190	13	100	600	D933IM18050	M18 x 50	578,760	27	25	150
D933IM08100	M8 x 100	133,730	13	100	600	D933IM18060	M18 x 60	646,843	27	25	150
D933IM10020	M10 x 20	70,523	17	200	800	D933IM18070	M18 x 70	719,170	27	25	100
D933IM10025	M10 x 25	73,960	17	200	800	D933IM18080	M18 x 80	787,273	27	25	100
D933IM10030	M10 x 30	83,610	17	200	800	D933IM18090	M18 x 90	855,367	27	25	100
D933IM10035	M10 x 35	91,153	17	200	800	D933IM18100	M18 x 100	923,457	27	25	100

Blíster

CÓDIGO	MEDIDA	€/BOLSA	PCS	BOLSAS
BZ3I04010	M4 x 10	2,459	6	20
BZ3I04016	M4 x 16	2,459	6	20
BZ3I04020	M4 x 20	2,459	6	20
BZ3I04030	M4 x 30	2,459	6	20
BZ3I04040	M4 x 40	2,459	6	20
BZ3I05010	M5 x 10	2,459	6	20
BZ3I05016	M5 x 16	2,459	6	20
BZ3I05020	M5 x 20	2,459	6	20
BZ3I05030	M5 x 30	2,459	6	20
BZ3I05040	M5 x 40	2,459	6	20
BZ3I05050	M5 x 50	2,459	6	20
BZ3I06016	M6 x 16	2,459	6	20
BZ3I06020	M6 x 20	2,459	6	20
BZ3I06025	M6 x 25	2,459	6	20
BZ3I06030	M6 x 30	2,459	6	20
BZ3I06040	M6 x 40	2,459	6	20
BZ3I06050	M6 x 50	2,459	6	20
BZ3I08016	M8 x 16	2,459	4	20
BZ3I08020	M8 x 20	2,459	4	20
BZ3I08025	M8 x 25	2,459	4	20
BZ3I08030	M8 x 30	2,459	4	20

Blíster

CÓDIGO	MEDIDA	€/BOLSA	PCS	BOLSAS
BZ3I08040	M8 x 40	2,459	4	20
BZ3I08050	M8 x 50	2,459	4	20
BZ3I08060	M8 x 60	2,459	4	20
BZ3I10020	M10 x 20	2,459	2	20
BZ3I10030	M10 x 30	2,459	2	20
BZ3I10040	M10 x 40	2,459	2	20

Caja ventana

CÓDIGO	MEDIDA	€/CAJA	PCS	CAJAS
VD933I04010	M4 x 10	5,313	40	8
VD933I04016	M4 x 16	6,363	40	8
VD933I04020	M4 x 20	7,055	40	8
VD933I04030	M4 x 30	6,783	30	8
VD933I04040	M4 x 40	7,433	25	8
VD933I05010	M5 x 10	5,551	40	8
VD933I05016	M5 x 16	6,509	40	8
VD933I05020	M5 x 20	7,369	40	8
VD933I05030	M5 x 30	4,905	20	8
VD933I05040	M5 x 40	6,101	20	8
VD933I05050	M5 x 50	3,919	10	8

Caja ventana

CÓDIGO	MEDIDA	€/CAJA	PCS	CAJAS
VD933I06010	M6 x 10	6,987	30	8
VD933I06016	M6 x 16	7,123	30	8
VD933I06020	M6 x 20	8,255	30	8
VD933I06025	M6 x 25	7,146	25	8
VD933I06030	M6 x 30	8,306	25	8
VD933I06040	M6 x 40	6,470	15	8
VD933I06050	M6 x 50	5,115	10	8
VD933I08016	M8 x 16	9,105	20	8
VD933I08020	M8 x 20	9,865	20	8
VD933I08025	M8 x 25	11,139	20	8
VD933I08030	M8 x 30	9,290	15	8
VD933I08040	M8 x 40	7,520	10	8
VD933I08050	M8 x 50	9,047	10	8
VD933I08060	M8 x 60	10,328	10	8
VD933I10020	M10 x 20	9,273	10	8
VD933I10030	M10 x 30	10,657	10	8
VD933I10040	M10 x 40	12,271	10	8
VD933I10050	M10 x 50	14,615	10	8
VD933I10060	M10 x 60	17,257	10	8

Tornillo cabeza hexagonal con arandela estampada y grafilada 8.8

DIN-6921

METAL



CÓDIGO	MEDIDA	€/100	LLAVE DE INSTALACIÓN		
6921108020	M8 x 20	50,523	13	200	2.400
6921108050	M8 x 50	80,817	13	100	600
6921108070	M8 x 70	117,303	13	100	600

DIN-6921 A2

Tornillo DIN-6921. Tornillo hexagonal con arandela estampada y grafilada. Inoxidable A2



Tornillo con cabeza redonda y cuello cuadrado. Inoxidable A2

DIN-603 A2

METAL



CÓDIGO	MEDIDA	€/100		
D603108016	M8 x 16	42,047	200	2.400



Disponible en varios recubrimientos. Consulte precio y plazo de entrega.

Tuerca hexagonal

DIN-934

INOXIDABLE



DIN-934 A2

Inoxidable A2

CÓDIGO	MEDIDA	€/100	LLAVE DE INSTALACIÓN		
D934IM04	M4	3,590	7	500	22.500
D934IM05	M5	4,151	8	500	12.000
D934IM06	M6	6,851	10	500	12.000
D934IM08	M8	13,895	13	250	4.000
D934IM10	M10	30,997	17	250	2.000
D934IM12	M12	45,447	19	250	1.500
D934IM14	M14	69,167	22	100	800
D934IM16	M16	97,060	24	100	600
D934IM18	M18	154,370	27	100	600
D934IM20	M20	202,697	30	50	400
D934IM22	M22	280,170	32	50	300
D934IM24	M24	364,217	36	25	200



Blíster



Caja ventana

CÓDIGO	MEDIDA	€/BOLSA	PCS 	BOLSAS 
BZ934IM04	M4	2,459	10	20
BZ934IM05	M5	2,459	8	20
BZ934IM06	M6	2,459	8	20
BZ934IM08	M8	2,459	6	20
BZ934IM10	M10	2,459	5	15

CÓDIGO	MEDIDA	€/CAJA	PCS 	CAJAS 
VD934IM04	M4	2,799	50	8
VD934IM05	M5	3,237	50	8
VD934IM06	M6	4,806	50	8
VD934IM08	M8	5,850	30	8
VD934IM10	M10	8,700	20	8

DIN-985

Tuerca autoblocante

DIN-985 A2

INOXIDABLE



Inoxidable A2



CÓDIGO	MEDIDA	€/100	LLAVE DE INSTALACIÓN		
D985IM04	M4	6,440	7	500	22.500
D985IM05	M5	6,933	8	500	8.000
D985IM06	M6	9,798	10	500	8.000
D985IM08	M8	20,448	13	250	4.000
D985IM10	M10	41,129	17	250	2.000
D985IM12	M12	63,931	19	100	1.200
D985IM14	M14	121,010	22	100	800
D985IM16	M16	146,667	24	50	600
D985IM18	M18	335,650	27	50	400
D985IM20	M20	430,477	30	25	300
D985IM22	M22	974,347	32	25	300
D985IM24	M24	1.313,707	36	25	150

Blíster

CÓDIGO	MEDIDA	€/BOLSA	PCS	BOLSAS
BZ985IM04	M4	2,459	10	20
BZ985IM05	M5	2,459	8	20
BZ985IM06	M6	2,459	8	20
BZ985IM08	M8	2,459	6	20
BZ985IM10	M10	2,459	5	15

Caja ventana

CÓDIGO	MEDIDA	€/CAJA	PCS	CAJAS
VD985IM04	M4	4,515	50	8
VD985IM05	M5	4,866	50	8
VD985IM06	M6	6,873	50	8
VD985IM08	M8	8,130	30	8
VD985IM10	M10	11,544	20	8

DIN-6923

Tuerca brida grafilada

DIN-6923 A2

METAL



Tuerca brida grafilada DIN-6923.
Inoxidable A2



CÓDIGO	MEDIDA	€/100	LLAVE DE INSTALACIÓN		
D6923IM08	M8	24,660	13	250	3.000
D6923IM10	M10	47,753	15	250	3.000
D6923IM12	M12	70,740	18	250	1.500

DIN-125

Arandela plana

DIN-125 A2

INOXIDABLE



Inoxidable A2



CÓDIGO	MEDIDA	€/100		
D125IM04	M4	1,217	500	22.500
D125IM05	M5	1,610	500	22.500
D125IM06	M6	2,917	500	22.500
D125IM08	M8	5,003	250	11.250
D125IM10	M10	9,557	250	6.000
D125IM12	M12	19,037	250	3.000
D125IM14	M14	26,643	200	2.400
D125IM16	M16	29,420	100	2.400
D125IM18	M18	43,627	100	1.600
D125IM20	M20	46,327	50	1.200
D125IM22	M22	54,937	50	1.200
D125IM24	M24	96,120	50	600

Blíster

CÓDIGO	MEDIDA	€/BOLSA	PCS	BOLSAS
BZ125IM04	M4	2,459	10	20
BZ125IM05	M5	2,459	8	20
BZ125IM06	M6	2,459	8	20
BZ125IM08	M8	2,459	6	20
BZ125IM10	M10	2,459	5	20

Caja ventana



CÓDIGO	MEDIDA	€/CAJA	PCS	CAJAS
VD125IM04	M4	2,986	100	8
VD125IM05	M5	2,995	75	8
VD125IM06	M6	3,788	75	8
VD125IM08	M8	3,949	50	8
VD125IM10	M10	6,581	50	8

Arandela muelle Grower

DIN-127

METAL



CÓDIGO	MEDIDA	€/100		
D127IM08	M8	4,530	200	9.000
D127IM10	M10	7,237	100	4.500
D127IM12	M12	10,923	100	4.500

DIN-127 A2

Arandela muelle grower DIN-127.
Inoxidable A2



Abrazadera reforzada M8 + M10

AB-RE

02 Info
P. 414 Técnica

INOXIDABLE



CÓDIGO	MEDIDA	ØD(mm)	€/100	MEDIDA EN PULGADAS	CARGA MÁXIMA		
ABREA2018	18 (M8+M10)	15 - 18	373,661	3/8"	150	50	300
ABREA2022	22 (M8+M10)	20 - 24	392,964	1/2"	150	50	200
ABREA2028	28 (M8+M10)	26 - 30	432,357	3/4"	150	50	150
ABREA2035	35 (M8+M10)	32 - 36	452,397	1"	150	50	100
ABREA2040	40 (M8+M10)	36 - 42	477,819	1 1/4"	150	25	100
ABREA2048	48 (M8+M10)	47 - 50	514,040	1 1/2"	150	25	100
ABREA2054	54 (M8+M10)	51 - 55	542,877	-	150	25	75
ABREA2060	60 (M8+M10)	60 - 64	560,049	2"	150	25	75
ABREA2075	75 (M8+M10)	75 - 80	623,047	2 1/2"	150	25	50
ABREA2090	90 (M8+M10)	87 - 92	716,872	3"	150	25	-
ABREA2110	110 (M8+M10)	106 - 112	775,557	-	150	25	-
ABREA2115	115 (M8+M10)	114 - 119	808,986	4"	150	25	-
ABREA2125	125 (M8+M10)	124 - 131	867,714	4 1/2"	150	25	-
ABREA2140	140 (M8+M10)	133 - 140	988,740	5"	150	25	-
ABREA2160	160 (M8+M10)	159 - 163	1.105,855	6"	150	25	-
ABREA2200	200 (M8+M10)	199 - 212	1.542,543	-	150	25	-

AB-RE A2

Inoxidable A2



02 Info
P. 414 Técnica

INOXIDABLE



CÓDIGO	MEDIDA	ØD(mm)	€/100	MEDIDA EN PULGADAS	CARGA MÁXIMA		
ABREA4018	18 (M8+M10)	15 - 18	443,636	3/8"	150	50	300
ABREA4022	22 (M8+M10)	20 - 24	455,645	1/2"	150	50	200
ABREA4028	28 (M8+M10)	26 - 30	486,630	3/4"	150	50	150
ABREA4035	35 (M8+M10)	32 - 36	538,263	1"	150	50	100
ABREA4040	40 (M8+M10)	36 - 42	561,349	1 1/4"	150	25	100
ABREA4048	48 (M8+M10)	47 - 50	623,794	1 1/2"	150	25	100
ABREA4054	54 (M8+M10)	51 - 55	650,789	-	150	25	75
ABREA4060	60 (M8+M10)	60 - 64	674,464	2"	150	25	75
ABREA4075	75 (M8+M10)	75 - 80	769,698	2 1/2"	150	25	50
ABREA4090	90 (M8+M10)	87 - 92	797,127	3"	150	25	-
ABREA4110	110 (M8+M10)	106 - 112	944,903	-	150	25	-
ABREA4115	115 (M8+M10)	114 - 119	1.013,731	4"	150	25	-
ABREA4125	125 (M8+M10)	124 - 131	1.056,970	4 1/2"	150	25	-
ABREA4140	140 (M8+M10)	133 - 140	1.286,906	5"	150	25	-
ABREA4160	160 (M8+M10)	159 - 163	1.373,386	-	150	25	-
ABREA4200	200 (M8+M10)	199 - 212	1.714,166	-	150	25	-

AB-RE A4

Inoxidable A4



AB-RI

Abrazadera isofónica reforzada M8 + M10

AB-RI A2

Inoxidable A2



02 Info. Técnica
P. 414

INOXIDABLE



CÓDIGO	MEDIDA	ØD(mm)	€/100	MEDIDA EN PULGADAS	CARGA MÁXIMA		
ABRIA2018	18 (M8+M10)	15 - 18	447,180	3/8"	150	50	200
ABRIA2022	22 (M8+M10)	20 - 24	459,518	1/2"	150	50	150
ABRIA2028	28 (M8+M10)	26 - 30	479,962	3/4"	150	50	150
ABRIA2035	35 (M8+M10)	32 - 36	504,966	1"	150	50	100
ABRIA2040	40 (M8+M10)	36 - 42	554,972	1 1/4"	150	25	75
ABRIA2048	48 (M8+M10)	47 - 50	588,180	1 1/2"	150	25	75
ABRIA2054	54 (M8+M10)	51 - 55	633,759	-	150	25	50
ABRIA2060	60 (M8+M10)	60 - 64	668,165	2"	150	25	50
ABRIA2075	75 (M8+M10)	75 - 80	752,739	2 1/2"	150	25	-
ABRIA2090	90 (M8+M10)	87 - 92	791,252	3"	150	25	-
ABRIA2110	110 (M8+M10)	106 - 112	902,766	-	150	25	-
ABRIA2115	115 (M8+M10)	114 - 119	885,612	4"	150	25	-
ABRIA2125	125 (M8+M10)	124 - 131	981,778	4 1/2"	150	25	-
ABRIA2140	140 (M8+M10)	133 - 140	1.057,112	5"	150	25	-
ABRIA2160	160 (M8+M10)	159 - 163	1.161,578	6"	150	25	-

AB-RI A4

Inoxidable A4



02 Info. Técnica
P. 414

INOXIDABLE



CÓDIGO	MEDIDA	ØD(mm)	€/100	MEDIDA EN PULGADAS	CARGA MÁXIMA		
ABRIA4018	18 (M8+M10)	15 - 18	561,302	3/8"	150	50	200
ABRIA4022	22 (M8+M10)	20 - 24	590,094	1/2"	150	50	150
ABRIA4028	28 (M8+M10)	26 - 30	615,950	3/4"	150	50	150
ABRIA4035	35 (M8+M10)	32 - 36	662,075	1"	150	50	100
ABRIA4040	40 (M8+M10)	36 - 42	713,620	1 1/4"	150	25	75
ABRIA4048	48 (M8+M10)	47 - 50	767,222	1 1/2"	150	25	75
ABRIA4054	54 (M8+M10)	51 - 55	805,178	-	150	25	50
ABRIA4060	60 (M8+M10)	60 - 64	880,125	2"	150	25	50
ABRIA4075	75 (M8+M10)	75 - 80	962,951	2 1/2"	150	25	-
ABRIA4090	90 (M8+M10)	87 - 92	1.056,571	3"	150	25	-
ABRIA4110	110 (M8+M10)	106 - 112	1.245,743	-	150	25	-
ABRIA4115	115 (M8+M10)	114 - 119	1.295,096	4"	150	25	-
ABRIA4125	125 (M8+M10)	124 - 131	1.372,003	4 1/2"	150	25	-
ABRIA4140	140 (M8+M10)	133 - 140	1.420,219	5"	150	25	-
ABRIA4160	160 (M8+M10)	159 - 163	1.669,673	6"	150	25	-

AB-ZI

Abarcón

AB-ZI A2

Inoxidable A2



SANEAMIENTO



CÓDIGO	MEDIDA	€/100	CARGA MÁXIMA		
AZA2060500	M6 1/2"	109,780	250	100	600
AZA2060750	M6 3/4"	127,623	250	100	600
AZA2061000	M6 1"	157,233	250	100	400
AZA2061250	M6 1 1/4"	186,167	250	50	300
AZA2081500	M8 1 1/2"	323,520	350	50	150
AZA2082000	M8 2"	376,290	350	50	150
AZA2082500	M8 2 1/2"	423,973	350	50	100
AZA2083000	M8 3"	460,830	350	50	100
AZA2104000	M10 4"	937,600	350	50	-
AZA2106000	M10 6"	1.209,237	350	25	-
AZA2108000	M10 8"	1.446,647	350	25	-



Abrazadera M6

AB-M6

Info
Técnica
P. 419

INOXIDABLE



CÓDIGO	MEDIDA	ØD(mm)	€/100	MEDIDA EN PULGADAS	CARGA MÁXIMA		
ABM6A2012	12 (M6)	12	269,863	1/4"	70	100	1.200
ABM6A2015	15 (M6)	14 - 15	274,740	-	70	100	600
ABM6A2018	18 (M6)	16 - 18	279,617	3/8"	70	100	600
ABM6A2020	20 (M6)	19 - 21	285,207	1/2"	70	100	600
ABM6A2022	22 (M6)	22 - 24	288,820	-	70	100	600
ABM6A2028	28 (M6)	25 - 30	305,037	3/4"	70	100	400

AB-M6 A2

Inoxidable A2





Abrazadera sin fin

AB-SF

Info
Técnica
P. 425

INOXIDABLE



CÓDIGO	MEDIDA	ØD(mm)	€/100	MEDIDA EN PULGADAS		
ASF2010016	10-16	10-16	95,663	-	100	1.200
ASF2012020	12-20	12-20	98,043	1/2"- 7/8"	100	600
ASF2016027	16-27	16 - 27	102,270	5/8"- 1 1/16"	100	600
ASF2020032	20-32	20 - 32	115,347	3/4"- 1 1/4"	100	600
ASF2025040	25-40	25 - 40	126,033	1"- 1 5/8"	100	200
ASF2032050	32-50	32 - 50	175,423	1 3/8"- 2"	100	300
ASF2040060	40-60	40 - 60	186,260	1 5/8"- 2 3/8"	100	200
ASF2050070	50-70	50 - 70	194,387	2"- 2 3/4"	50	100
ASF2060080	60-80	60 - 80	204,343	2 3/8"- 3 1/8"	50	100
ASF2070090	70-90	70 - 90	215,207	2 3/4"- 3 1/2"	50	100
ASF2080100	80-100	80 - 100	222,420	3 1/8"- 4"	50	100
ASF2090110	90-110	90 - 110	259,380	3 1/2"- 4 3/8"	50	100
ASF2100120	100-120	100 - 120	269,563	4"- 4 3/4"	25	25
ASF2110130	110-130	110 - 130	279,720	4 3/8"- 5 1/8"	25	25
ASF2120140	120-140	120 - 140	293,967	4 3/4"- 5 1/2"	25	25
ASF2130150	130-150	130 - 150	305,160	5 1/8"- 5 7/8"	25	25

AB-SF A2

Inoxidable A2



Abrazadera sin fin inoxidable en rollo

AB-SF IR

INOXIDABLE



CÓDIGO	MEDIDA	€/PC		
ASFIR03	9 x 0,6 mm/ 3 m	14,867	1	50

AB-SF IR

Kit (Rollo 3 m. + 8 cabezales).
Inoxidable



INOXIDABLE



CÓDIGO	MEDIDA	€/100		
ASFIRCA	Cabezal	106,197	50	1.000

AB-SF IRC

Cabezal inoxidable



AB-SF IR

Abrazadera sin fin inoxidable en rollo

AB-SF IRR

Rollo 30 m. Inoxidable



INOXIDABLE



CÓDIGO	MEDIDA	€/PC		
ASFIR30	9 x 0,6 mm / 30 m	53,097	1	10

CI-PE

Cinta perforada

CI-PE A2

Cinta perforada curva. Inoxidable A2



INOXIDABLE



CÓDIGO	MEDIDA	€/PC		
CIPEA21708	17 x 0,8 x 10 m	36,422	1	30

AB-IT

Abrazadera inoxidable Indextube

AB-ITS

Simple



SANEAMIENTO



CÓDIGO	MEDIDA	€/100		
ABITS015	15	193,863	100	600
ABITS018	18	210,063	100	400
ABITS022	22	311,367	100	400
ABITS028	28	418,547	100	300

AB-ITD

Doble



SANEAMIENTO



CÓDIGO	MEDIDA	€/100		
ABITD015	15	716,737	50	300
ABITD018	18	811,463	50	200
ABITD022	22	1.016,350	50	100

Perfiles para cargas ligeras tipo "C"

GP

INOXIDABLE



CÓDIGO	MEDIDA	€/100	LONGITUD	
GPI271812	27 x 18 x 1,25 x 2000	11.696,187	2.000	6
GPI283015	28 x 30 x 1,50 x 2000	18.898,134	2.000	6
GPI384020	38 x 40 x 2,00 x 2000	39.110,865	-	5

GP-A2

Guía perforada inoxidable A2



Accesorios para perfiles tipo "C"

PE-AC

INOXIDABLE



CÓDIGO	MEDIDA	VÁLIDO PARA	€/100		
EMI45	50 x 50 45°	27/18 - 28/30 - 38/40	634,667	50	200
EMI90	54 x 54 90°	27/18 - 28/30 - 38/40	634,667	50	-
EMI00	100 180°	27/18 - 28/30 - 38/40	629,223	50	200

EG-A2

Escuadra inoxidable A2



INOXIDABLE



CÓDIGO	MEDIDA	VÁLIDO PARA	€/100		
PGI2718	27 / 18 x 81	27/18	309,567	50	300
PGI2830	28 / 30 x 81	28/30	356,003	50	200
PGI3840	38 / 40 x 93	38/40	433,393	50	100

PG-A2

Puente guía inoxidable A2



Grapas y galgas para montaje de placas

ISF-GG

METAL



CÓDIGO	MEDIDA	€/100		
KFRSC3050	30 - 50	583,910	10	240

KFR-SC

Grapa fijación rápida



ISF-CC

Conectores + Complementos para montaje de estructuras solares

KFS-FI

Conector cruzado para fijación inferior. Inoxidable A2

METAL



CÓDIGO	MEDIDA	€/100		
KFSFI08	M8	165,977	100	900

TU-RX A2

Tuerca rápida INDEXTRUT. Inoxidable A2

METAL



CÓDIGO	MEDIDA	€/100		
TURXA208	M8	141,600	50	300

DIN-603 A2

Tornillo DIN-603. Cabeza redonda y cuello cuadrado. Inoxidable A2

METAL



CÓDIGO	MEDIDA	€/100		
D603I08016	M8 x 16	42,047	200	2.400



Disponible en varios recubrimientos. Consulte precio y plazo de entrega.

DIN-6921 A2

Tornillo DIN-6921. Tornillo hexagonal con arandela estampada y grafiada. Inoxidable A2

METAL



CÓDIGO	MEDIDA	€/100	LLAVE DE INSTALACIÓN		
6921I08020	M8 x 20	50,523	13	200	2.400
6921I08050	M8 x 50	80,817	13	100	600
6921I08070	M8 x 70	117,303	13	100	600

METAL



CÓDIGO	MEDIDA	€/100	LLAVE DE INSTALACIÓN		
D6923IM08	M8	24,660	13	250	3.000
D6923IM10	M10	47,753	15	250	3.000
D6923IM12	M12	70,740	18	250	1.500



DIN-6923 A2

Tuerca brida grafilada DIN-6923. Inoxidable A2



METAL



CÓDIGO	MEDIDA	€/100		
D127IM08	M8	4,530	200	9.000
D127IM10	M10	7,237	100	4.500
D127IM12	M12	10,923	100	4.500

DIN-127 A2



Arandela muelle grower DIN-127. Inoxidable A2



Espárragos regulables para la instalación de placas solares

METAL



CÓDIGO	MEDIDA	€/100	LLAVE DE INSTALACIÓN		
KFSMA10200	10 x 200	555,310	7	25	150
KFSMA10250	10 x 250	626,317	7	25	150
KFSMA12300 NEW	12 x 300	1.214,187	9	25	75
KFSMA12350 NEW	12 x 350	1.321,193	9	25	75

KFS-MA

Espárrago doble rosca. Inoxidable A2



METAL



CÓDIGO	MEDIDA	€/100	LLAVE DE INSTALACIÓN		
KFSAU10160	10 x 160	2.496,347	13	25	150
KFSAU10200	10 x 200	2.896,505	13	25	75

KFS-AU

Kit tornillo autorroscante. Inoxidable A2



METAL



CÓDIGO	MEDIDA	€/100	LLAVE DE INSTALACIÓN		
KFSRV10250	10 x 250	626,317	7	25	150
KFSRV12350	12 x 350	1.228,876	9	25	75

KFS-RV

Varilla roscada para instalación con anclaje químico. Inoxidable A2



ISF-FR

Accesorios regulables para la instalación de placas solares

GS-TC

Gancho salvateja ajustable para teja curva. Inoxidable A2



METAL



CÓDIGO	MEDIDA	€/100	
GSTC040080	40 - 80	2.659,303	20
GSTC080120	80 - 120	2.709,631	20

GS-TU

Gancho salvateja ajustable para teja universal. Inoxidable A2



METAL



CÓDIGO	MEDIDA	€/100	
GSTU040055	40 - 55	2.872,957	20

STR

Soporte regulable para perfil trapecoidal. Inoxidable A2



METAL



CÓDIGO	MEDIDA	€/100	
STR1680	16 - 80	1.944,180	40



PMO

Placa para tornillo doble rosca. Inoxidable A2



METAL



CÓDIGO	MEDIDA	€/100		
PMO1012	M10 -M12	263,027	25	300

Accesorios de fijación directa para la instalación de placas solares

ISF-FD

METAL



Chapa

TAC BIMETAL+ARVUL A2

Tornillo de cosido Bimetal + Arandela vulcanizada EPDM-inoxidable A2

CÓDIGO	MEDIDA	€/100	Nº HUELLA		
TACB166025	6 x 25 P16	99,783	8	500	2.000



Accesorios de estanqueidad para la instalación de placas solares



ISF-ES

METAL



ARS-P

Arandela paraguas inoxidable A2 + EPDM

CÓDIGO	MEDIDA	€/100		
ARSP08	M8	51,876	100	1.200
ARSP10	M10	51,876	100	1.200



Kits para instalaciones solares

ISF-KT

METAL



KT-PSE

Triangular con perfil de aluminio PSE-A. Fijación ensamblada

CÓDIGO	MEDIDA	€/PC	
KTPSE0235	x2 (35 mm) - ORIGEN	380,747	1
KTPSE0240	x2 (40 mm) - ORIGEN	380,747	1
KTPSE0335	x3 (35 mm) - ORIGEN	542,080	1
KTPSE0340	x3 (40 mm) - ORIGEN	542,080	1
KTPSE0330 NEW	x3 (30 mm) - ORIGEN	542,080	1
KTPSE03AM NEW	x3 - AMPLIACION	529,173	1
KTPSE0230 NEW	x2 (30 mm) - ORIGEN	380,747	1
KTPSE02AM NEW	x2 - AMPLIACION	375,907	1



RV

Varilla roscada

RV-A2

Inoxidable A2. 1 metro

INOXIDABLE



CÓDIGO	MEDIDA	€/100	LONGITUD	PASO	
975A2M04	M4 x 1000	342,703	1.000	0.7	1
975A2M05	M5 x 1000	404,100	1.000	0.8	1
975A2M06	M6 x 1000	557,927	1.000	1	1
975A2M08	M8 x 1000	905,410	1.000	1.25	1
975A2M10	M10 x 1000	1.311,617	1.000	1.5	1
975A2M12	M12 x 1000	1.996,787	1.000	1.75	1
975A2M14	M14 x 1000	3.496,623	1.000	2	1
975A2M16	M16 x 1000	4.037,627	1.000	2	1
975A2M18	M18 x 1000	4.404,683	1.000	2.5	1
975A2M20	M20 x 1000	6.078,463	1.000	2.5	1
975A2M22	M22 x 1000	7.105,490	1.000	2.5	1
975A2M24	M24 x 1000	9.591,407	1.000	3	1
975A2M27	M27 x 1000	11.559,623	1.000	3	1
975A2M30	M30 x 1000	17.990,670	1.000	3.5	1
975A2M33	M33 x 1000	22.586,227	1.000	3.5	1
975A2M36	M36 x 1000	25.977,823	1.000	4	1

MA

Manguito de unión

MA-RI

Redondo. Inoxidable A2

INOXIDABLE



CÓDIGO	MEDIDA	€/100	LONGITUD		
MARI0830	M8 x 30	204,683	30	100	2.400
MARI1030	M10 x 30	281,790	30	100	-

TAG

Tirafondo abrazadera y grapa

AB-TA A2

Inoxidable A2



INOXIDABLE



CÓDIGO	MEDIDA	€/100		
ABTA20630	M6 x 30	84,600	100	2.400

ES-DR

Espárrago de doble rosca

ES-DA2

Inoxidable A2. TX



INOXIDABLE



CÓDIGO	MEDIDA	€/100	LLAVE DE INSTALACIÓN		
ESDA208060	M8 x 60	123,333	6	100	800
ESDA210060	M10 x 60	208,583	8	100	800

Pletina de fijación



PF

INOXIDABLE



PF-A4

Inoxidable A4

CÓDIGO	MEDIDA	€/100		
PFA4M0800	M8	303,137	100	600
PFA4M0810	M8 + M10	361,303	100	600
PFA4M1000	M10	346,320	100	600



Soportes de fijación para sanitarios

SA

SANEAMIENTO



CÓDIGO	MEDIDA	€/KIT	
SAIL06080	M6 x 80	2,926	100

Fijación de WC y bidé con taco largo.
2 PCS x KIT



SANEAMIENTO



CÓDIGO	MEDIDA	€/KIT	
SACI06080	M6 x 80	5,727	100

Fijación de cisterna. 2 PCS x KIT



TAMBIÉN DISPONIBLE EN
easykits

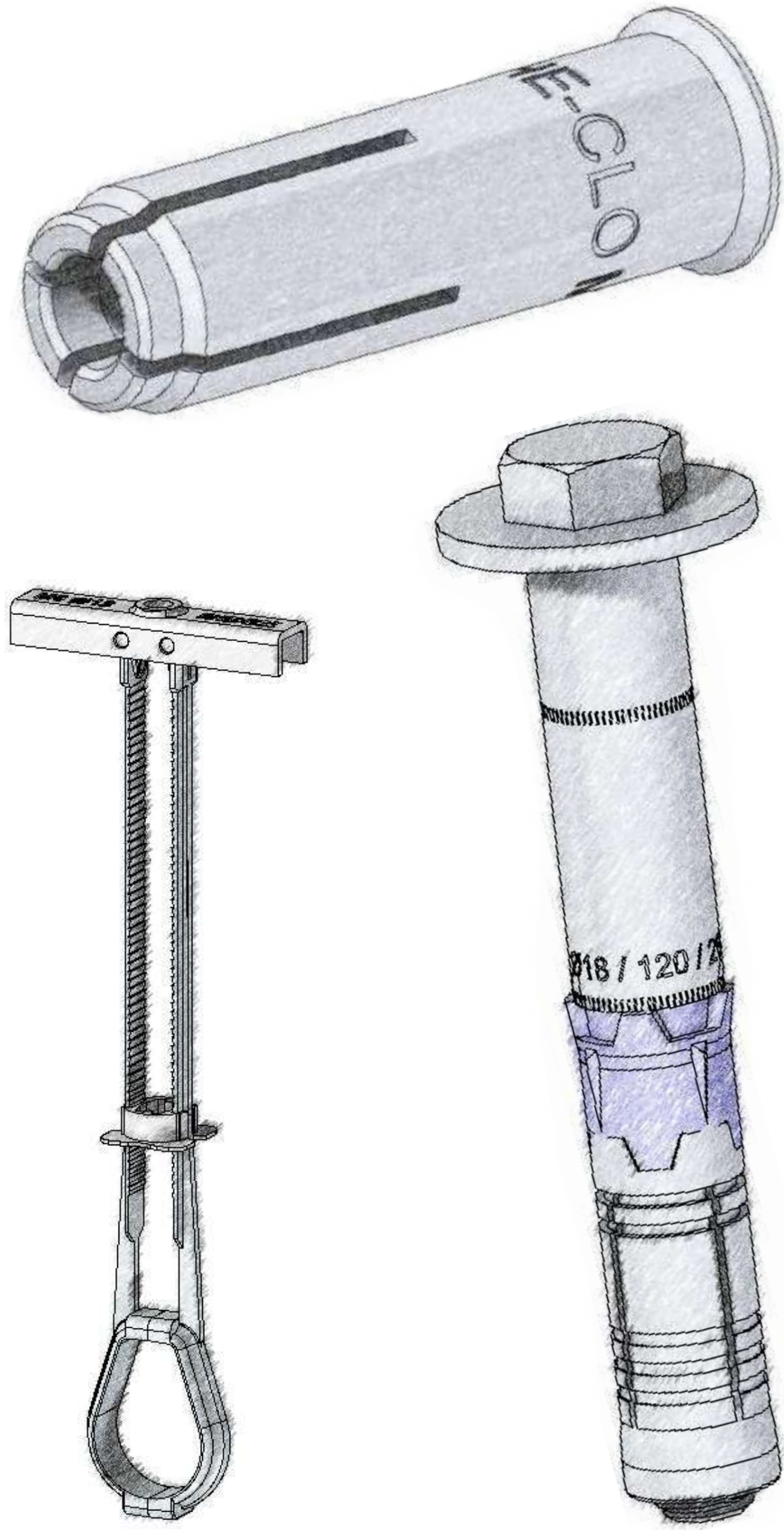

CARACTERÍSTICAS TÉCNICAS

PARÁMETROS TÉCNICOS DE INSTALACIÓN

En las siguientes páginas encontrarás una serie de datos de consulta rápida que te ayudarán a elegir el producto adecuado para tu instalación. Si deseas ampliar esta información puedes consultar nuestra documentación técnica en: www.indexfix.com

Los datos que primero encontrarás son de carácter descriptivo y nos ayudan a entender la geometría del anclaje y su código de referencia correspondiente. Los siguientes son parámetros de instalación del producto, utilizando como unidades de distancia los mm, kg para las cargas máximas recomendadas y Nm para el par de apriete de los anclajes.

La mayoría de productos vienen acompañados de un croquis acotado, el significado de estas cotas para los anclajes se describe a continuación:

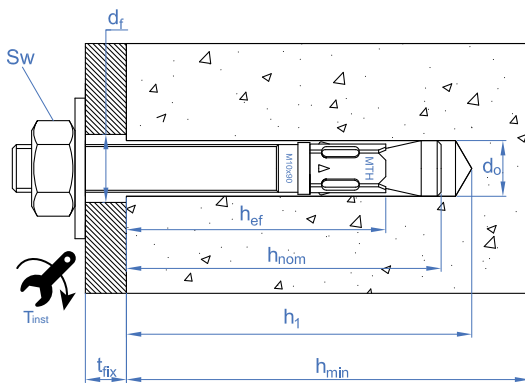

d_o	diámetro de broca o diámetro del taladro [mm]
h_1	profundidad mínima del taladro o agujero [mm]
h_{min}	espesor mínimo del material base [mm]
d_f	diámetro del agujero del elemento a fijar [mm]
h_{nom}	profundidad de instalación del anclaje [mm]
t_{fix}	espesor máximo a fijar [mm]
t_{inst}	par de apriete necesario para la correcta expansión del anclaje [Nm]
C_{cr}	distancia crítica al borde [mm]
S_c	distancia crítica entre anclajes [mm]
h_{ef}	profundidad efectiva del anclaje [mm]
SW	llave de instalación o distancia entre caras de la tuerca [mm]

EXTRACCIÓN

Carga máxima recomendada a tracción que puede resistir el anclaje. Ésta ha sido calculada aplicando un factor de seguridad 1.4 a la resistencia de cálculo del anclaje y está expresada en kg. Este factor aplica para hormigón fisurado y no fisurado. Para otros materiales el factor de seguridad puede llegar hasta 2.5.

CIZALLADURA

Carga máxima recomendada a cortante que puede resistir el anclaje. Ésta ha sido calculada aplicando un factor de seguridad 1.4 a la resistencia de cálculo del anclaje y está expresada en kg. Este factor aplica para hormigón fisurado y no fisurado. Para otros materiales el factor de seguridad puede llegar hasta 2.5.

MTP

Anclaje macho para cargas altas en hormigón fisurado y no fisurado

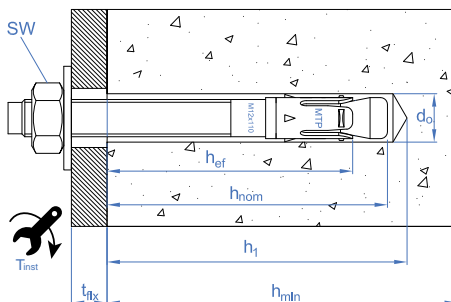

MTP

Homologado ETE Opt.1. Eje cincado. Clip Inoxidable A4

CÓDIGO	MXL	ESPOSOR MÁX. A FIJAR	Ø BROCA	PROFUNDIDAD MÍN. DE TALADRO	PROFUNDIDAD MÍN. DEL ANCLAJE	LLAVE DE INSTALACIÓN	PAR DE APRIETE (NM)	LETRA EJE	Ø ELEMENTO A FIJAR	MÍN. ESPESOR MATERIAL BASE	DISTANCIA MÍN. AL BORDE "A"	DISTANCIA MÍN. ENTRE EJES "B"	EXTRACCIÓN HORMIGÓN NO-FISURADO	CIZALLADURA HORMIGÓN NO-FISURADO	EXTRACCIÓN HORMIGÓN FISURADO	CIZALLADURA HORMIGÓN FISURADO
AP08050	M8 x 50	2	8	40	37	13	20	A	9	100	72	144	182	392	130	275
AP08075	M8 x 75	9	8	60	55	13	20	C	9	100	72	144	364	641	202	556
AP08095	M8 x 95	29	8	60	55	13	20	E	9	100	72	144	364	641	202	556
AP08115	M8 x 115	49	8	60	55	13	20	G	9	100	72	144	364	641	202	556
AP10090	M10 x 90	10	10	75	68	17	40	E	12	120	90	180	874	1014	461	1014
AP10105	M10 x 105	25	10	75	68	17	40	F	12	120	90	180	874	1014	461	1014
AP10115	M10 x 115	35	10	75	68	17	40	G	12	120	90	180	874	1014	461	1014
AP10135	M10 x 135	55	10	75	68	17	40	H	12	120	90	180	874	1014	461	1014
AP10165	M10 x 165	85	10	75	68	17	40	K	12	120	90	180	874	1014	461	1014
AP10185	M10 x 185	105	10	75	68	17	40	L	12	120	90	180	874	1014	461	1014
AP12080	M12 x 80	4	12	85	80	19	60	D	14	140	105	210	971	1474	582	1474
AP12100	M12 x 100	4	12	85	80	19	60	E	14	140	105	210	971	1474	582	1474
AP12110	M12 x 110	14	12	85	80	19	60	F	14	140	105	210	971	1474	582	1474
AP12120	M12 x 120	24	12	85	80	19	60	G	14	140	105	210	971	1474	582	1474
AP12130	M12 x 130	34	12	85	80	19	60	H	14	140	105	210	971	1474	582	1474
AP12150	M12 x 150	54	12	85	80	19	60	I	14	140	105	210	971	1474	582	1474
AP12180	M12 x 180	84	12	85	80	19	60	L	14	140	105	210	971	1474	582	1474
AP12200	M12 x 200	104	12	85	80	19	60	M	14	140	105	210	971	1474	582	1474
AP16145	M16 x 145	28	16	105	97	24	100	I	18	170	128	255	1747	2744	1214	2620
AP16175	M16 x 175	58	16	105	97	24	100	K	18	170	128	255	1747	2744	1214	2620
AP16220	M16 x 220	103	16	105	97	24	100	O	18	170	128	255	1747	2744	1214	2620
AP16250	M16 x 250	133	16	105	97	24	100	Q	18	170	128	255	1747	2744	1214	2620
AP20170	M20 x 170	32	20	125	114	30	200	K	22	200	150	300	2330	4258	1553	3343
AP20200	M20 x 200	62	20	125	114	30	200	N	22	200	150	300	2330	4258	1553	3343
AP24205	M24 x 205	35	24	155	143	36	250	N	26	250	188	375	2225	4934	1416	4672
AP24235	M24 x 235	65	24	155	143	36	250	P	26	250	188	375	2225	4934	1416	4672

MTP-A4

Homologado ETE Opt.1. Eje Inoxidable A4. Clip Inoxidable A4

CÓDIGO	MXL	ESPOSOR MÁX. A FIJAR	Ø BROCA	PROFUNDIDAD MÍN. DE TALADRO	PROFUNDIDAD MÍN. DEL ANCLAJE	LLAVE DE INSTALACIÓN	PAR DE APRIETE (NM)	LETRA EJE	Ø ELEMENTO A FIJAR	MÍN. ESPESOR MATERIAL BASE	DISTANCIA MÍN. AL BORDE "A"	DISTANCIA MÍN. ENTRE EJES "B"	EXTRACCIÓN HORMIGÓN NO-FISURADO	CIZALLADURA HORMIGÓN NO-FISURADO	EXTRACCIÓN HORMIGÓN FISURADO	CIZALLADURA HORMIGÓN FISURADO
APA408075	M8 x 75	9	8	60	55	13	15	C	9	100	144	72	582	693	413	556
APA408095	M8 x 95	29	8	60	55	13	15	E	9	100	144	72	582	693	413	556
APA408115	M8 x 115	49	8	60	55	13	15	G	9	100	144	72	582	693	413	556
APA408135	M8 x 135	69	8	60	55	13	15	H	9	100	144	72	582	693	413	556
APA410090	M10 x 90	10	10	75	68	17	30	E	12	120	180	90	777	1101	413	556
APA410105	M10 x 105	25	10	75	68	17	30	F	12	120	180	90	777	1101	413	556
APA410115	M10 x 115	35	10	75	68	17	30	G	12	120	180	90	777	1101	680	1101
APA410135	M10 x 135	55	10	75	68	17	30	H	12	120	180	90	777	1101	680	1101
APA410165	M10 x 165	85	10	75	68	17	30	K	12	120	180	90	777	1101	680	1101
APA410185	M10 x 185	105	10	75	68	17	30	L	12	120	180	90	777	1101	680	1101
APA412110	M12 x 110	14	12	85	80	19	60	F	14	140	210	105	890	1596	769	1596
APA412120	M12 x 120	24	12	85	80	19	60	G	14	140	210	105	890	1596	769	1596
APA412130	M12 x 130	34	12	85	80	19	60	H	14	140	210	105	890	1596	769	1596
APA412150	M12 x 150	54	12	85	80	19	60	I	14	140	210	105	890	1596	769	1596
APA412180	M12 x 180	84	12	85	80	19	60	L	14	140	210	105	890	1596	769	1596
APA412200	M12 x 200	104	12	85	80	19	60	M	14	140	210	105	890	1596	769	1596
APA416125	M16 x 125	8	16	105	97	24	100	G	18	170	255	128	890	1596	769	1596
APA416145	M16 x 145	28	16	105	97	24	100	I	18	170	255	128	1559	3204	1092	2620
APA416175	M16 x 175	58	16	105	97	24	100	K	18	170	255	128	1559	3204	1092	2620
APA416190	M16 x 190	73	16	105	97	24	100	L	18	170	255	128	1559	3204	1092	2620
APA416220	M16 x 220	103	16	105	97	24	100	O	18	170	255	128	1559	3204	1092	2620
APA420200	M20 x 200	62	20	125	114	30	200	M	22	200	300	150	1990	4776	1393	3343
APA420240	M20 x 240	102	20	125	114	30	200	P	22	200	300	150	1990	4776	1393	3343
APA420285	M20 x 285	147	20	125	114	30	200	S	22	200	300	150	1990	4776	1393	3343

MTP-X

Homologado ETE Opt.1. Eje Cincado. Clip ATLANTIS C3-L

CÓDIGO	MXL	ESPEJOR MÁX. A FIJAR	Ø BROCA	PROFUNDIDAD MÍN. DE TALADRO	PROFUNDIDAD MÍN. DEL ANCLAJE	LLAVE DE INSTALACIÓN	PAR DE APRIETE (NM)	LETRA EJE	Ø ELEMENTO A FIJAR	MÍN. ESPEJOR MATERIAL BASE	DISTANCIA MÍN. AL BORDE "A"	DISTANCIA MÍN. ENTRE EJES "B"	EXTRACCIÓN HORMIGÓN NO-FISURADO	CIZALLADURA HORMIGÓN NO-FISURADO	EXTRACCIÓN HORMIGÓN FISURADO	CIZALLADURA HORMIGÓN FISURADO
APX08050	M8 x 50	2	8	40	37	13	15	A	9	100	72	144	182	392	130	275
APX08075	M8 x 75	9	8	60	55	13	15	C	9	100	72	144	405	641	283	556
APX08080	M8 x 80	14	8	60	55	13	15	D	9	100	72	144	405	641	283	556
APX08095	M8 x 95	29	8	60	55	13	15	E	9	100	72	144	405	641	283	556
APX08115	M8 x 115	49	8	60	55	13	15	G	9	100	72	144	405	641	283	556
APX10090	M10 x 90	10	10	75	68	17	40	E	12	120	90	180	874	1014	534	1014
APX10105	M10 x 105	25	10	75	68	17	40	F	12	120	90	180	874	1014	534	1014
APX10115	M10 x 115	35	10	75	68	17	40	G	12	120	90	180	874	1014	534	1014
APX10135	M10 x 135	55	10	75	68	17	40	H	12	120	90	180	874	1014	534	1014
APX10165	M10 x 165	85	10	75	68	17	40	K	12	120	90	180	874	1014	534	1014
APX10185	M10 x 185	105	10	75	68	17	40	L	12	120	90	180	874	1014	534	1014
APX12080	M12 x 80	4	12	65	60	19	60	D	14	100	105	210	488	1474	348	1182
APX12100	M12 x 100	4	12	85	80	19	60	E	14	140	105	210	1359	1474	728	1474
APX12110	M12 x 110	14	12	85	80	19	60	F	14	140	105	210	1359	1474	728	1474
APX12120	M12 x 120	24	12	85	80	19	60	G	14	140	105	210	1359	1474	728	1474
APX12130	M12 x 130	34	12	85	80	19	60	H	14	140	105	210	1359	1474	728	1474
APX12150	M12 x 150	54	12	85	80	19	60	I	14	140	105	210	1359	1474	728	1474
APX12180	M12 x 180	84	12	85	80	19	60	L	14	140	105	210	1359	1474	728	1474
APX12200	M12 x 200	104	12	85	80	19	60	M	14	140	105	210	1359	1474	728	1474
APX12220	M12 x 220	124	12	85	80	19	60	O	14	140	105	210	1359	1474	728	1474
APX12255	M12 x 255	159	12	85	80	19	60	R	14	140	105	210	1359	1474	728	1474
APX16145	M16 x 145	28	16	105	97	24	100	I	18	170	128	255	1650	2744	1310	2620
APX16175	M16 x 175	58	16	105	97	24	100	K	18	170	128	255	1650	2744	1310	2620
APX16220	M16 x 220	103	16	105	97	24	100	O	18	170	128	255	1650	2744	1310	2620
APX16250	M16 x 250	133	16	105	97	24	100	Q	18	170	128	255	1650	2744	1310	2620
APX20170	M20 x 170	32	20	125	114	30	200	K	22	200	150	300	2388	4258	1672	3343
APX20200	M20 x 200	62	20	125	114	30	200	M	22	200	150	300	2388	4258	1672	3343

MTP-G

Homologado ETE Opt.1. Eje ATLANTIS C3-L. Clip Inoxidable A4

CÓDIGO	MXL	ESPEJOR MÁX. A FIJAR	Ø BROCA	PROFUNDIDAD MÍN. DE TALADRO	PROFUNDIDAD MÍN. DEL ANCLAJE	LLAVE DE INSTALACIÓN	PAR DE APRIETE (NM)	LETRA EJE	Ø ELEMENTO A FIJAR	MÍN. ESPEJOR MATERIAL BASE	DISTANCIA MÍN. AL BORDE "A"	DISTANCIA MÍN. ENTRE EJES "B"	EXTRACCIÓN HORMIGÓN NO-FISURADO	CIZALLADURA HORMIGÓN NO-FISURADO	EXTRACCIÓN HORMIGÓN FISURADO	CIZALLADURA HORMIGÓN FISURADO
APG06060	M6 x 60	10	6	50	46	10	7	B	7	100	60	120	243	352	-	-
APG06070	M6 x 70	20	6	50	46	10	7	C	7	100	60	120	243	352	-	-
APG06100	M6 x 100	50	6	50	46	10	7	E	7	100	60	120	243	352	-	-
APG08050	M8 x 50	2	8	40	37	13	15	A	9	100	72	144	182	392	130	275
APG08060	M8 x 60	12	8	40	37	13	15	B	9	100	72	144	182	392	130	275
APG08075	M8 x 75	9	8	60	55	13	15	C	9	100	72	144	405	641	243	556
APG08095	M8 x 95	29	8	60	55	13	15	E	9	100	72	144	405	641	243	556
APG08115	M8 x 115	49	8	60	55	13	15	G	9	100	72	144	405	641	243	556
APG10070	M10 x 70	5	10	60	53	17	40	C	12	100	90	180	325	1014	232	1009
APG10090	M10 x 90	10	10	75	68	17	40	E	12	120	90	180	874	1014	485	1014
APG10105	M10 x 105	25	10	75	68	17	40	F	12	120	90	180	874	1014	485	1014
APG10115	M10 x 115	35	10	75	68	17	40	G	12	120	90	180	874	1014	485	1014
APG10135	M10 x 135	55	10	75	68	17	40	H	12	120	90	180	874	1014	485	1014
APG10165	M10 x 165	85	10	75	68	17	40	K	12	120	90	180	874	1014	485	1014
APG10185	M10 x 185	105	10	75	68	17	40	L	12	120	90	180	874	1014	485	1014
APG12080	M12 x 80	4	12	65	60	19	60	D	14	100	105	210	585	1474	417	1182
APG12110	M12 x 110	14	12	85	80	19	60	F	14	140	105	210	1399	1474	777	1474
APG12130	M12 x 130	34	12	85	80	19	60	H	14	140	105	210	1399	1474	777	1474
APG12150	M12 x 150	54	12	85	80	19	60	I	14	140	105	210	1399	1474	777	1474
APG12180	M12 x 180	84	12	85	80	19	60	L	14	140	105	210	1399	1474	777	1474
APG12200	M12 x 200	104	12	85	80	19	60	M	14	140	105	210	1399	1474	777	1474
APG16125	M16 x 125	8	16	105	97	24	100	G	18	170	128	255	1747	2744	1310	2620
APG16145	M16 x 145	28	16	105	97	24	100	I	18	170	128	255	1747	2744	1310	2620
APG16175	M16 x 175	58	16	105	97	24	100	K	18	170	128	255	1747	2744	1310	2620
APG16220	M16 x 220	103	16	105	97	24	100	O	18	170	128	255	1747	2744	1310	2620
APG20170	M20 x 170	32	20	125	114	30	200	K	22	200	150	300	2388	4258	1456	3343
APG20200	M20 x 200	62	20	125	114	30	200	M	22	200	150	300	2388	4258	1456	3343

MTH

Anclaje macho para cargas altas en hormigón no fisurado

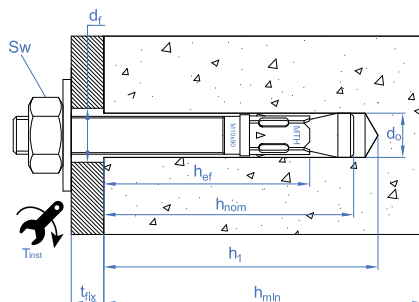

MTH

Homologado ETE Opt.7. Eje cincado. Clip cincado

CÓDIGO	MXL	ESPESOR MÁX. A FIJAR	Ø BROCA	PROFUNDIDAD MÍN. DE TALADRO	PROFUNDIDAD MÍN. DEL ANCLAJE	LLAVE DE INSTALACIÓN	PAR DE APRIETE (NM)	LETRA EJE	Ø ELEMENTO A FIJAR	MÍN. ESPESOR MATERIAL BASE	DISTANCIA MÍN. AL BORDE "A"	DISTANCIA MÍN. ENTRE EJES "B"	EXTRACCIÓN HORMIGÓN NO-FISURADO	CIZALLADURA HORMIGÓN NO-FISURADO
AH06060	M6 x 60	2	6	55	50	10	7	B	7	100	60	120	385	297
AH06070	M6 x 70	12	6	55	50	10	7	C	7	100	60	120	385	297
AH06080	M6 x 80	22	6	55	50	10	7	D	7	100	60	120	385	297
AH06090	M6 x 90	32	6	55	50	10	7	E	7	100	60	120	385	297
AH06100	M6 x 100	42	6	55	50	10	7	E	7	100	60	120	385	297
AH06110	M6 x 110	52	6	55	50	10	7	F	7	100	60	120	385	297
AH06120	M6 x 120	62	6	55	50	10	7	G	7	100	60	120	385	297
AH06130	M6 x 130	72	6	55	50	10	7	H	7	100	60	120	385	297
AH06140	M6 x 140	82	6	55	50	10	7	I	7	100	60	120	385	297
AH06150	M6 x 150	92	6	55	50	10	7	I	7	100	60	120	385	297
AH06160	M6 x 160	102	6	55	50	10	7	J	7	100	60	120	385	297
AH06170	M6 x 170	112	6	55	50	10	7	K	7	100	60	120	385	297
AH06180	M6 x 180	122	6	55	50	10	7	L	7	100	60	120	385	297
AH08060	M8 x 60	3	8	50	50	13	20	B	9	100	53	105	485	494
AH08075	M8 x 75	5	8	65	60	13	20	C	9	100	72	144	676	542
AH08090	M8 x 90	20	8	65	60	13	20	E	9	100	72	144	676	542
AH08100	M8 x 100	30	8	65	60	13	20	E	9	100	72	144	676	542
AH08115	M8 x 115	45	8	65	60	13	20	G	9	100	72	144	676	542
AH08120	M8 x 120	50	8	65	60	13	20	G	9	100	72	144	676	542
AH08130	M8 x 130	60	8	65	60	13	20	H	9	100	72	144	676	542
AH08155	M8 x 155	85	8	65	60	13	20	J	9	100	72	144	676	542
AH10070	M10 x 70	3	10	60	54	17	35	C	12	100	63	126	650	650
AH10080	M10 x 80	13	10	60	54	17	35	D	12	100	63	126	650	650
AH10090	M10 x 90	10	10	75	67	17	35	E	12	110	83	165	922	856
AH10100	M10 x 100	20	10	75	67	17	35	E	12	110	83	165	922	856
AH10120	M10 x 120	40	10	75	67	17	35	G	12	110	83	165	922	856
AH10140	M10 x 140	60	10	75	67	17	35	H	12	110	83	165	922	856
AH10150	M10 x 150	70	10	75	67	17	35	I	12	110	83	165	922	856
AH10160	M10 x 160	80	10	75	67	17	35	J	12	110	83	165	922	856
AH10170	M10 x 170	90	10	75	67	17	35	K	12	110	83	165	922	856
AH10210	M10 x 210	130	10	75	67	17	35	N	12	110	83	165	922	856
AH10230	M10 x 230	150	10	75	67	17	35	P	12	110	83	165	922	856
AH12090	M12 x 90	13	12	70	60	19	60	E	14	100	75	150	844	844
AH12100	M12 x 100	8	12	85	77	19	60	E	14	130	98	195	1251	1200
AH12110	M12 x 110	18	12	85	77	19	60	F	14	130	98	195	1251	1200
AH12120	M12 x 120	28	12	85	77	19	60	G	14	130	98	195	1251	1200
AH12130	M12 x 130	38	12	85	77	19	60	H	14	130	98	195	1251	1200
AH12140	M12 x 140	48	12	85	77	19	60	H	14	130	98	195	1251	1200
AH12160	M12 x 160	68	12	85	77	19	60	J	14	130	98	195	1251	1200
AH12180	M12 x 180	88	12	85	77	19	60	L	14	130	98	195	1251	1200
AH12200	M12 x 200	108	12	85	77	19	60	M	14	130	98	195	1251	1200
AH12220	M12 x 220	128	12	85	77	19	60	O	14	130	98	195	1251	1200
AH12250	M12 x 250	158	12	85	77	19	60	Q	14	130	98	195	1251	1200
AH14120	M14 x 120	12	14	100	91	22	90	G	16	150	113	225	1551	1637
AH14145	M14 x 145	37	14	100	91	22	90	I	16	150	113	225	1551	1637
AH14170	M14 x 170	62	14	100	91	22	90	K	16	150	113	225	1551	1637
AH14220	M14 x 220	112	14	100	91	22	90	O	16	150	113	225	1551	1637
AH14250	M14 x 250	142	14	100	91	22	90	Q	16	150	113	225	1551	1637
AH16125	M16 x 125	3	16	110	104	24	120	G	18	168	126	252	1887	2237
AH16145	M16 x 145	23	16	110	104	24	120	I	18	168	126	252	1887	2237
AH16170	M16 x 170	48	16	110	104	24	120	K	18	168	126	252	1887	2237
AH16220	M16 x 220	98	16	110	104	24	120	O	18	168	126	252	1887	2237
AH16250	M16 x 250	128	16	110	104	24	120	Q	18	168	126	252	1887	2237
AH16280	M16 x 280	158	16	110	104	24	120	S	18	168	126	252	1887	2237

CÓDIGO	MXL	ESPESOR MÁX. A FIJAR	Ø BROCA	PROFUNDIDAD MIN. DE TALADRO	PROFUNDIDAD MIN. DEL ANCLAJE	LLAVE DE INSTALACIÓN	PAR DE APRIETE (NM)	LETRA EJE	Ø ELEMENTO A FIJAR	MÍN. ESPESOR MATERIAL BASE	DISTANCIA MIN. AL BORDE "A"	DISTANCIA MIN. ENTRE EJES "B"	EXTRACCIÓN HORMIGÓN NO-FISURADO	CIZALLADURA HORMIGÓN NO-FISURADO
AH20170	M20 x 170	23	20	135	125	30	240	K	22	206	155	309	2496	3279
AH20220	M20 x 220	73	20	135	125	30	240	O	22	206	155	309	2496	3279
AH20270	M20 x 270	123	20	135	125	30	240	S	22	206	155	309	2496	3279

MTH-A4 Homologado ETE Opt.7. Eje Inoxidable A4. Clip Inoxidable A4

CÓDIGO	MXL	ESPESOR MÁX. A FIJAR	Ø BROCA	PROFUNDIDAD MIN. DE TALADRO	PROFUNDIDAD MIN. DEL ANCLAJE	LLAVE DE INSTALACIÓN	PAR DE APRIETE (NM)	LETRA EJE	Ø ELEMENTO A FIJAR	MÍN. ESPESOR MATERIAL BASE	DISTANCIA MIN. AL BORDE "A"	DISTANCIA MIN. ENTRE EJES "B"	EXTRACCIÓN HORMIGÓN NO-FISURADO	CIZALLADURA HORMIGÓN NO-FISURADO
MIA406045	M6 x 45	1	6	40	35	10	7	A	7	100	40	75	298	287
MIA406060	M6 x 60	2	6	55	50	10	7	B	7	100	60	120	438	287
MIA406080	M6 x 80	22	6	55	50	10	7	D	7	100	60	120	438	287
MIA408050	M8 x 50	4	8	40	35	13	20	A	9	100	40	75	219	263
MIA408075	M8 x 75	5	8	65	60	13	20	C	9	100	72	144	582	522
MIA408090	M8 x 90	20	8	65	60	13	20	E	9	100	72	144	582	522
MIA408115	M8 x 115	45	8	65	60	13	20	G	9	100	72	144	582	522
MIA410070	M10 x 70	3	10	60	54	17	35	C	12	100	60	120	485	650
MIA410090	M10 x 90	10	10	75	67	17	35	E	12	110	83	165	647	834
MIA410120	M10 x 120	40	10	75	67	17	35	G	12	110	83	165	647	834
MIA410150	M10 x 150	70	10	75	67	17	35	I	12	110	83	165	647	834
MIA412075	M12 x 75	5	12	60	55	19	60	C	14	100	65	130	561	673
MIA412090	M12 x 90	13	12	70	62	19	60	D	14	100	75	90	647	844
MIA412110	M12 x 110	18	12	85	77	19	60	F	14	130	98	195	1011	1207
MIA412140	M12 x 140	48	12	85	77	19	60	I	14	130	98	195	1011	1207
MIA416090	M16 x 90	4	16	75	69	24	120	D	18	100	75	150	683	819
MIA416145	M16 x 145	23	16	110	104	24	120	I	18	168	126	252	1416	2256
MIA416170	M16 x 170	48	16	110	104	24	120	K	18	168	126	252	1416	2256
MIA420120	M20 x 120	5	20	105	93	30	240	G	22	145	110	225	1190	2857
MIA420170	M20 x 170	23	20	135	125	30	240	K	22	206	155	309	2023	3521
MIA420220	M20 x 220	73	20	135	125	30	240	O	22	206	155	309	2023	3521

MTH-A2 Homologado ETE Opt.7. Eje Inoxidable A2. Clip Inoxidable A2

CÓDIGO	MXL	ESPESOR MÁX. A FIJAR	Ø BROCA	PROFUNDIDAD MIN. DE TALADRO	PROFUNDIDAD MIN. DEL ANCLAJE	LLAVE DE INSTALACIÓN	PAR DE APRIETE (NM)	LETRA EJE	Ø ELEMENTO A FIJAR	MÍN. ESPESOR MATERIAL BASE	DISTANCIA MIN. AL BORDE "A"	DISTANCIA MIN. ENTRE EJES "B"	EXTRACCIÓN HORMIGÓN NO-FISURADO	CIZALLADURA HORMIGÓN NO-FISURADO
MI06045	M6 x 45	1	6	40	35	10	7	A	7	100	40	75	298	287
MI06060	M6 x 60	2	6	55	50	10	7	B	7	100	60	120	438	287
MI06080	M6 x 80	22	6	55	50	10	7	D	7	100	60	120	438	287
MI06120	M6 x 120	62	6	55	50	10	7	G	7	100	60	120	438	287
MI06140	M6 x 140	82	6	55	50	10	7	I	7	100	60	120	438	287
MI06160	M6 x 160	102	6	55	50	10	7	J	7	100	60	120	438	287
MI06170	M6 x 170	112	6	55	50	10	7	K	7	100	60	120	438	287
MI06180	M6 x 180	122	6	55	50	10	7	L	7	100	60	120	438	287
MI08050	M8 x 50	4	8	40	35	13	20	A	9	100	40	75	219	263
MI08075	M8 x 75	5	8	65	60	13	20	C	9	100	72	144	582	522
MI08090	M8 x 90	20	8	65	60	13	20	E	9	100	72	144	582	522
MI08115	M8 x 115	45	8	65	60	13	20	G	9	100	72	144	582	522
MI10070	M10 x 70	3	10	60	54	17	35	C	12	100	60	120	485	650
MI10090	M10 x 90	10	10	75	67	17	35	E	12	110	83	165	647	834
MI10120	M10 x 120	40	10	75	67	17	35	G	12	110	83	165	647	834
MI10150	M10 x 150	70	10	75	67	17	35	I	12	110	83	165	647	834
MI12075	M12 x 75	5	12	60	55	19	60	C	14	100	65	130	561	672
MI12090	M12 x 90	13	12	70	62	19	60	D	14	120	75	150	647	844
MI12110	M12 x 110	18	12	85	77	19	60	F	14	130	98	195	1011	1207
MI12140	M12 x 140	48	12	85	77	19	60	I	14	130	98	195	1011	1207
MI16090	M16 x 90	4	16	75	69	24	120	D	18	100	75	150	683	819
MI16145	M16 x 145	23	16	110	104	24	120	I	18	168	126	252	1416	2256
MI16170	M16 x 170	48	16	110	104	24	120	K	18	168	126	252	1416	2256
MI20120	M20 x 120	5	20	105	93	30	240	G	22	145	110	225	1190	2857
MI20170	M20 x 170	23	20	135	125	30	240	K	22	206	155	309	2023	3521
MI20220	M20 x 220	73	20	135	125	30	240	O	22	206	155	309	2023	3521

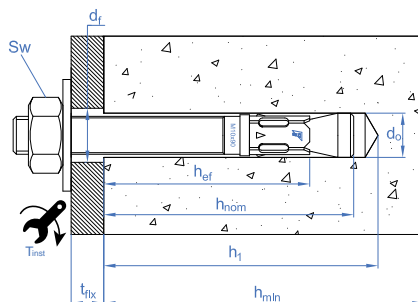

MTA

Eje cincado. Clip cincado

CÓDIGO	MXL	ESPESOR MÁX. A FIJAR	Ø BROCA	PROFUNDIDAD MIN. DE TALADRO	PROFUNDIDAD MIN. DEL ANCLAJE	LLAVE DE INSTALACIÓN	PAR DE APRIETE (NM)	Ø ELEMENTO A FIJAR	MÍN. ESPESOR MATERIAL BASE	DISTANCIA MIN. AL BORDE "A"	DISTANCIA MIN. ENTRE EJES "B"	EXTRACCIÓN HORMIGÓN NO-FISURADO	CIZALLADURA HORMIGÓN NO-FISURADO
AM06045	M6 x 45	1	6	40	35	10	7	7	100	40	75	298	297
AM06055	M6 x 55	11	6	40	35	10	7	7	100	40	75	298	297
AM06060	M6 x 60	2	6	55	50	10	7	7	100	60	120	385	297
AM06065	M6 x 65	7	6	55	50	10	7	7	100	60	120	385	297
AM06070	M6 x 70	12	6	55	50	10	7	7	100	60	120	385	297
AM06080	M6 x 80	22	6	55	50	10	7	7	100	60	120	385	297
AM06085	M6 x 85	27	6	55	50	10	7	7	100	60	120	385	297
AM06090	M6 x 90	32	6	55	50	10	7	7	100	60	120	385	297
AM06100	M6 x 100	42	6	55	50	10	7	7	100	60	120	385	297
AM06110	M6 x 110	52	6	55	50	10	7	7	100	60	120	385	297
AM06120	M6 x 120	62	6	55	50	10	7	7	100	60	120	385	297
AM06130	M6 x 130	72	6	55	50	10	7	7	100	60	120	385	297
AM06140	M6 x 140	82	6	55	50	10	7	7	100	60	120	385	297
AM06150	M6 x 150	92	6	55	50	10	7	7	100	60	120	385	297
AM06160	M6 x 160	102	6	55	50	10	7	7	100	60	120	385	297
AM06170	M6 x 170	112	6	55	50	10	7	7	100	60	120	385	297
AM06180	M6 x 180	122	6	55	50	10	7	7	100	60	120	385	297
AM08050	M8 x 50	4	8	40	35	13	20	9	100	40	75	263	263
AM08060	M8 x 60	3	8	50	47	13	20	9	100	53	105	485	494
AM08065	M8 x 65	8	8	50	47	13	20	9	100	53	105	485	494
AM08075	M8 x 75	5	8	65	60	13	20	9	100	72	144	676	542
AM08090	M8 x 90	20	8	65	60	13	20	9	100	72	144	676	542
AM08115	M8 x 115	45	8	65	60	13	20	9	100	72	144	676	542
AM08120	M8 x 120	50	8	65	60	13	20	9	100	72	144	676	542
AM08130	M8 x 130	60	8	65	60	13	20	9	100	72	144	676	542
AM08155	M8 x 155	85	8	65	60	13	20	9	100	72	144	676	542
AM10065	M10 x 65	1	10	55	52	17	35	12	100	60	120	604	604
AM10070	M10 x 70	3	10	60	54	17	35	12	100	63	125	650	650
AM10080	M10 x 80	13	10	60	54	17	35	12	100	63	125	667	667
AM10090	M10 x 90	10	10	75	67	17	35	12	110	83	165	922	856
AM10100	M10 x 100	15	10	75	67	17	35	12	110	83	165	-	-
AM10120	M10 x 120	20	10	75	67	17	35	12	110	83	165	922	856
AM10140	M10 x 140	40	10	75	67	17	35	12	110	83	165	922	856
AM10150	M10 x 150	60	10	75	67	17	35	12	110	83	165	922	856
AM10160	M10 x 160	70	10	75	67	17	35	12	110	83	165	922	856
AM10170	M10 x 170	80	10	75	67	17	35	12	110	83	165	922	856
AM10210	M10 x 210	90	10	75	67	17	35	12	110	83	165	922	856
AM10230	M10 x 230	130	10	75	67	17	35	12	110	83	165	922	856
AM12075	M12 x 75	150	10	75	67	17	35	12	110	83	165	922	856
AM12080	M12 x 80	5	12	60	55	19	60	14	100	65	130	673	673
AM12090	M12 x 90	3	12	70	62	19	60	14	100	75	150	844	844
AM12100	M12 x 100	13	12	70	62	19	60	14	100	75	150	844	844
AM12110	M12 x 110	8	12	85	77	19	60	14	130	98	195	1251	1200
AM12120	M12 x 120	18	12	85	77	19	60	14	130	98	195	1251	1200
AM12140	M12 x 140	28	12	85	77	19	60	14	130	98	195	1251	1200
AM12160	M12 x 160	48	12	85	77	19	60	14	130	98	195	1251	1200

CÓDIGO	MXL	ESPESOR MÁX. A FIJAR	Ø BROCA	PROFUNDIDAD MÍN. DE TALADRO	PROFUNDIDAD MÍN. DEL ANCLAJE	LLAVE DE INSTALACIÓN	PAR DE APRIETE (NM)	Ø ELEMENTO A FIJAR	MÍN. ESPESOR MATERIAL BASE	DISTANCIA MÍN. AL BORDE "A"	DISTANCIA MÍN. ENTRE EJES "B"	EXTRACCIÓN HORMIGÓN NO-FISURADO	CIZALLADURA HORMIGÓN NO-FISURADO
AM12180	M12 x 180	68	12	85	77	19	60	14	130	98	195	1251	1200
AM12220	M12 x 220	88	12	85	77	19	60	14	130	98	195	1251	1200
AM12250	M12 x 250	128	12	85	77	19	60	14	130	98	195	1251	1200
AM14080	M14 x 80	158	12	85	77	19	60	14	130	98	195	1251	1200
AM14100	M14 x 100	5	14	65	59	22	90	16	100	65	130	650	650
AM14120	M14 x 120	5	14	85	69	22	90	16	125	95	190	1166	1637
AM14145	M14 x 145	12	14	100	91	22	90	16	150	113	225	1551	1637
AM14170	M14 x 170	37	14	100	91	22	90	16	150	113	225	1551	1637
AM14220	M14 x 220	62	14	100	91	22	90	16	150	113	225	1551	1637
AM14250	M14 x 250	112	14	100	91	22	90	16	150	113	225	1551	1637
AM16090	M16 x 90	142	14	100	91	22	90	16	150	113	225	1551	1637
AM16110	M16 x 110	4	16	75	69	24	120	18	100	75	150	819	819
AM16125	M16 x 125	7	16	75	69	24	120	18	100	75	150	1838	2237
AM16145	M16 x 145	3	16	110	104	24	120	18	168	126	252	1838	2237
AM16170	M16 x 170	23	16	110	104	24	120	18	168	126	252	1838	2237
AM16220	M16 x 220	48	16	110	104	24	120	18	168	126	252	1838	2237
AM16250	M16 x 250	98	16	110	104	24	120	18	168	126	252	1838	2237
AM16280	M16 x 280	128	16	110	104	24	120	18	168	126	252	1838	2237
AM20120	M20 x 120	158	16	110	104	24	120	18	168	126	252	1838	2237
AM20170	M20 x 170	30	20	105	93	30	240	22	145	110	225	-	-
AM20220	M20 x 220	23	20	135	125	30	240	22	206	155	309	2496	3279
AM20270	M20 x 270	73	20	135	125	30	240	22	206	155	309	2496	3279
AM24180	M24 x 180	123	20	135	125	30	240	22	206	155	309	2496	3279
AM24260	M24 x 260	10	24	155	143	36	250	26	250	200	400	2023	4934

TH Anclaje de fijación directa en hormigón

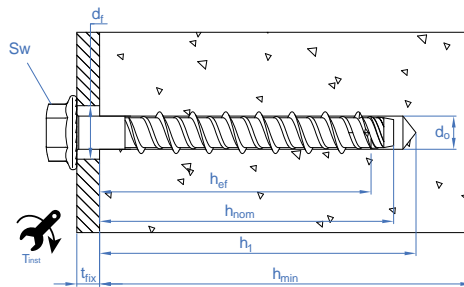

THE Homologado ETE Opt.1. Cabeza hexagonal con recubrimiento ATLANTIS C3-H

CÓDIGO	MXL	LONGITUD	Ø BROCA	PROFUNDIDAD MÍN. DE TALADRO	MÍN. ESPESOR MATERIAL BASE	Ø ELEMENTO A FIJAR	PROFUNDIDAD MÍN. DEL ANCLAJE	ESPESOR MÁX. A FIJAR	PAR DE APRIETE (NM)	DISTANCIA MÍN. AL BORDE "A"	DISTANCIA MÍN. ENTRE EJES "B"	LLAVE DE INSTALACIÓN	EXTRACCIÓN HORMIGÓN NO-FISURADO	CIZALLADURA HORMIGÓN NO-FISURADO	EXTRACCIÓN HORMIGÓN FISURADO	CIZALLADURA HORMIGÓN FISURADO
THE05040	Ø5 x 40	40	5	45	80	8	35	5	8	40	80	8	326	326	228	228
THE05050	Ø5 x 50	50	5	55	80	8	45	5	8	53	105	8	494	398	346	346
THE05060	Ø5 x 60	60	5	55	80	8	45	15	8	53	105	8	494	398	346	346
THE05080	Ø5 x 80	80	5	55	80	8	45	35	8	53	105	8	494	398	346	346
THE05100	Ø5 x 100	100	5	55	80	8	45	55	8	53	105	8	494	398	346	346
THE06040	Ø6 x 40	40	6	45	100	9	35	5	10	39	78	10	202	608	185	454
THE06050	Ø6 x 50	50	6	45	100	9	35	15	10	39	78	10	202	608	185	454
THE06060	Ø6 x 60	60	6	65	100	9	55	5	10	65	129	10	673	608	471	542
THE06070	Ø6 x 70	70	6	65	100	9	55	15	10	65	129	10	673	608	471	542
THE06080	Ø6 x 80	80	6	65	100	9	55	25	10	65	129	10	673	608	471	542
THE06100	Ø6 x 100	100	6	65	100	9	55	45	10	65	129	10	673	608	471	542
THE06120	Ø6 x 120	120	6	65	100	9	55	65	10	65	129	10	673	608	471	542
THE08055	Ø8 x 55	55	8	60	100	12	50	5	20	57	113	13	457	950	320	691
THE08060	Ø8 x 60	60	8	60	100	12	50	10	20	57	113	13	457	950	320	691
THE08070	Ø8 x 70	70	8	75	100	12	65	5	20	76	152	13	857	950	600	762
THE08080	Ø8 x 80	80	8	75	100	12	65	15	20	76	152	13	857	950	600	762
THE08090	Ø8 x 90	90	8	75	100	12	65	25	20	76	152	13	857	950	600	762
THE08100	Ø8 x 100	100	8	75	100	12	65	35	20	76	152	13	857	950	600	762
THE08110	Ø8 x 110	110	8	75	100	12	65	45	20	76	152	13	857	950	600	762
THE08120	Ø8 x 120	120	8	75	100	12	65	55	20	76	152	13	857	950	600	762
THE08140	Ø8 x 140	140	8	75	100	12	65	75	20	76	152	13	857	950	600	762
THE10060	Ø10 x 60	60	10	65	100	14	55	5	30	63	125	15	638	1245	447	871
THE10070	Ø10 x 70	70	10	65	100	14	55	15	30	63	125	15	638	1245	447	871
THE10080	Ø10 x 80	80	10	65	100	14	55	25	30	63	125	15	638	1245	447	871

CÓDIGO	MXL	LONGITUD	Ø BROCA	PROFUNDIDAD MÍN. DE TALADRO	MÍN. ESPESOR MATERIAL BASE	Ø ELEMENTO A FIJAR	PROFUNDIDAD MÍN. DEL ANCLAJE	ESPESOR MÁX. A FIJAR	PAR DE APRIETE (NM)	DISTANCIA MÍN. AL BORDE "A"	DISTANCIA MÍN. ENTRE EJES "B"	LLAVE DE INSTALACIÓN	EXTRACCIÓN HORMIGÓN NO-FISURADO	CIZALLADURA HORMIGÓN NO-FISURADO	EXTRACCIÓN HORMIGÓN FISURADO	CIZALLADURA HORMIGÓN FISURADO
THE10090	Ø10 x 90	90	10	95	135	14	85	5	30	101	201	15	1310	1330	917	1330
THE10100	Ø10 x 100	100	10	95	135	14	85	15	30	101	201	15	1310	1330	917	1330
THE10120	Ø10 x 120	120	10	95	135	14	85	35	30	101	201	15	1310	1330	917	1330
THE10140	Ø10 x 140	140	10	95	135	14	85	55	30	101	201	15	1310	1330	917	1330
THE12080	Ø12 x 80	80	12	90	120	16	75	5	50	87	174	18	1055	1808	738	1720
THE12090	Ø12 x 90	90	12	90	120	16	75	15	50	87	174	18	1055	1808	738	1720
THE12110	Ø12 x 110	110	12	120	170	16	105	5	50	126	251	18	1822	1808	1275	1808
THE12130	Ø12 x 130	130	12	120	170	16	105	25	50	126	251	18	1822	1808	1275	1808
THE12150	Ø12 x 150	150	12	120	170	16	105	45	50	126	251	18	1822	1808	1275	1808
THE14080	Ø14 x 80	80	14	90	120	18	75	5	70	87	174	21	1055	2559	738	1883
THE14100	Ø14 x 100	100	14	90	120	18	75	25	70	87	174	21	1055	2559	738	1883
THE14120	Ø14 x 120	120	14	130	185	18	115	5	70	138	276	21	2107	2559	1475	2559
THE14130	Ø14 x 130	130	14	130	185	18	115	15	70	138	276	21	2107	2559	1475	2559
THE14140	Ø14 x 140	140	14	130	185	18	115	25	70	138	276	21	2107	2559	1475	2559
THE14160	Ø14 x 160	160	14	130	185	18	115	45	70	138	276	21	2107	2559	1475	2559
THE16100	Ø16 x 100	100	-	-	-	-	-	-	-	-	-	-	-	-	-	-
THE16150	Ø16 x 150	150	-	-	-	-	-	-	-	-	-	-	-	-	-	-
THE18100	Ø18 x 100	100	18	110	140	22	90	10	90	105	209	24	1384	3680	968	2576
THE18130	Ø18 x 130	130	18	110	140	22	90	40	90	105	209	24	1384	3680	968	2576
THE18160	Ø18 x 160	160	18	160	225	22	140	20	90	168	336	24	2830	3921	1981	3921
THE18180	Ø18 x 180	180	18	160	225	22	140	40	90	168	336	24	2830	3921	1981	3921
THE18200	Ø18 x 200	200	18	160	225	22	140	60	90	168	336	24	2830	3921	1981	3921

THA Homologado ETE Opt.1. Cabeza avellanada con recubrimiento ATLANTIS C3-H

CÓDIGO	MXL	LONGITUD	Ø BROCA	PROFUNDIDAD MÍN. DE TALADRO	MÍN. ESPESOR MATERIAL BASE	Ø ELEMENTO A FIJAR	PROFUNDIDAD MÍN. DEL ANCLAJE	ESPESOR MÁX. A FIJAR	PAR DE APRIETE (NM)	DISTANCIA MÍN. AL BORDE "A"	DISTANCIA MÍN. ENTRE EJES "B"	LLAVE DE INSTALACIÓN	EXTRACCIÓN HORMIGÓN NO-FISURADO	CIZALLADURA HORMIGÓN NO-FISURADO	EXTRACCIÓN HORMIGÓN FISURADO	CIZALLADURA HORMIGÓN FISURADO
THA05040	Ø5 x 40	40	5	45	80	8	35	5	8	40	80	TX25	326	326	228	228
THA05060	Ø5 x 60	60	5	55	80	8	45	15	8	53	105	TX25	494	398	346	346
THA05080	Ø5 x 80	80	5	55	80	8	45	35	8	53	105	TX25	494	398	346	346
THA05100	Ø5 x 100	100	5	55	80	8	45	55	8	53	105	TX25	494	398	346	346
THA06045	Ø6 x 45	45	6	45	100	9	35	10	10	39	78	TX30	202	608	185	454
THA06050	Ø6 x 50	50	6	45	100	9	35	15	10	39	78	TX30	202	608	185	454
THA06060	Ø6 x 60	60	6	65	100	9	55	5	10	65	129	TX30	673	608	471	542
THA06080	Ø6 x 80	80	6	65	100	9	55	25	10	65	129	TX30	673	608	471	542
THA06120	Ø6 x 120	120	6	65	100	9	55	65	10	65	129	TX30	673	608	471	542
THA06140	Ø6 x 140	140	6	65	100	9	55	85	10	65	129	TX30	673	608	471	542
THA08060	Ø8 x 60	60	8	60	100	12	50	10	20	57	113	TX45	457	950	320	691
THA08080	Ø8 x 80	80	8	75	100	12	65	15	20	76	152	TX45	857	950	600	762
THA08100	Ø8 x 100	100	8	75	100	12	65	35	20	76	152	TX45	857	950	600	762
THA08120	Ø8 x 120	120	8	75	100	12	65	55	20	76	152	TX45	857	950	600	762
THA10100	Ø10 x 100	100	10	95	135	14	85	15	30	101	201	TX50	1310	1330	600	762
THA10120	Ø10 x 120	120	10	95	135	14	85	35	30	101	201	TX50	1310	1330	600	762

THP Homologado ETE Opt.1. Cabeza alomada con recubrimiento ATLANTIS C3-H

CÓDIGO	MXL	LONGITUD	Ø BROCA	PROFUNDIDAD MÍN. DE TALADRO	MÍN. ESPESOR MATERIAL BASE	Ø ELEMENTO A FIJAR	PROFUNDIDAD MÍN. DEL ANCLAJE	ESPESOR MÁX. A FIJAR	PAR DE APRIETE (NM)	DISTANCIA MÍN. AL BORDE "A"	DISTANCIA MÍN. ENTRE EJES "B"	LLAVE DE INSTALACIÓN	EXTRACCIÓN HORMIGÓN NO-FISURADO	CIZALLADURA HORMIGÓN NO-FISURADO	EXTRACCIÓN HORMIGÓN FISURADO	CIZALLADURA HORMIGÓN FISURADO
THP05040	Ø5 x 40	40	5	45	80	8	35	5	8	40	80	TX30	326	326	228	228
THP05060	Ø5 x 60	60	5	65	80	8	55	15	8	53	105	TX30	494	398	346	346
THP06040	Ø6 x 40	40	6	45	100	9	35	5	10	39	78	TX40	202	608	185	454
THP06050	Ø6 x 50	50	6	45	100	9	35	15	10	39	78	TX40	202	608	185	454
THP06060	Ø6 x 60	60	6	65	100	9	55	5	10	65	129	TX40	673	608	471	542
THP06080	Ø6 x 80	80	6	65	100	9	55	25	10	65	129	TX40	673	608	471	542
THP06100	Ø6 x 100	100	6	65	100	9	55	45	10	65	129	TX40	673	608	471	542
THP08060	Ø8 x 60	60	8	60	100	12	50	10	20	57	113	TX45	457	950	320	691
THP08080	Ø8 x 80	80	8	75	100	12	65	15	20	76	152	TX45	857	950	600	762

THT Homologado ETE Opt.1. Cabeza Truss con recubrimiento ATLANTIS C3-H

CÓDIGO	MXL	LONGITUD	Ø BROCA	PROFUNDIDAD MÍN. DE TALADRO	MÍN. ESPESOR MATERIAL BASE	Ø ELEMENTO A FIJAR	PROFUNDIDAD MÍN. DEL ANCLAJE	ESPESOR MÁX. A FIJAR	PAR DE APRIETE (NM)	DISTANCIA MÍN. AL BORDE "A"	DISTANCIA MÍN. ENTRE EJES "B"	LLAVE DE INSTALACIÓN	EXTRACCIÓN HORMIGÓN NO-FISURADO	CIZALLADURA HORMIGÓN NO-FISURADO	EXTRACCIÓN HORMIGÓN FISURADO	CIZALLADURA HORMIGÓN FISURADO
THT06040	Ø6 x 40	40	6	45	100	9	35	5	10	39	78	TX30	202	608	185	454
THT06050	Ø6 x 50	50	6	45	100	9	35	15	10	39	78	TX30	202	608	185	454
THT06060	Ø6 x 60	60	6	65	100	9	55	5	10	65	129	TX30	673	608	471	542

TFE Homologado ETE Opt.1. Cabeza hexagonal con recubrimiento cincado

CÓDIGO	MXL	LONGITUD	Ø BROCA	PROFUNDIDAD MÍN. DE TALADRO	MÍN. ESPESOR MATERIAL BASE	Ø ELEMENTO A FIJAR	PROFUNDIDAD MÍN. DEL ANCLAJE	ESPESOR MÁX. A FIJAR	PAR DE APRIETE (NM)	DISTANCIA MÍN. AL BORDE "A"	DISTANCIA MÍN. ENTRE EJES "B"	LLAVE DE INSTALACIÓN	EXTRACCIÓN HORMIGÓN NO-FISURADO	CIZALLADURA HORMIGÓN NO-FISURADO	EXTRACCIÓN HORMIGÓN FISURADO	CIZALLADURA HORMIGÓN FISURADO
TFE05040	Ø5 x 40	40	5	45	80	8	35	5	8	40	80	8	326	326	228	228
TFE05050	Ø5 x 50	50	5	55	80	8	45	5	8	53	105	8	494	398	346	346
TFE05060	Ø5 x 60	60	5	55	80	8	45	15	8	53	105	8	494	398	346	346

01
02
03

CARACTERÍSTICAS TÉCNICAS

CÓDIGO	MXL	LONGITUD	Ø BROCA	PROFUNDIDAD MÍN. DE TALADRO	MÍN. ESPESOR MATERIAL BASE	Ø ELEMENTO A FIJAR	PROFUNDIDAD MÍN. DEL ANCLAJE	ESPEJOR MÁX. A FIJAR	PAR DE APRIETE (NM)	DISTANCIA MÍN. AL BORDE "A"	DISTANCIA MÍN. ENTRE EJES "B"	LLAVE DE INSTALACIÓN	EXTRACCIÓN HORMIGÓN NO-FISURADO	CIZALLADURA HORMIGÓN NO-FISURADO	EXTRACCIÓN HORMIGÓN FISURADO	CIZALLADURA HORMIGÓN FISURADO
TFE05080	Ø5 x 80	80	5	55	80	8	45	35	8	53	105	8	494	398	346	346
TFE05100	Ø5 x 100	100	5	55	80	8	45	55	8	53	105	8	494	398	346	346
TFE06040	Ø6 x 40	40	6	45	100	9	35	5	10	39	78	10	202	608	185	454
TFE06050	Ø6 x 50	50	6	45	100	9	35	15	10	39	78	10	202	608	185	454
TFE06060	Ø6 x 60	60	6	65	100	9	55	5	10	65	129	10	673	608	471	542
TFE06070	Ø6 x 70	70	6	65	100	9	55	15	10	65	129	10	673	608	471	542
TFE06080	Ø6 x 80	80	6	65	100	9	55	25	10	65	129	10	673	608	471	542
TFE06100	Ø6 x 100	100	6	65	100	9	55	45	10	65	129	10	673	608	471	542
TFE06120	Ø6 x 120	120	6	65	100	9	55	65	10	65	129	10	673	608	471	542
TFE08055	Ø8 x 55	55	8	60	100	12	50	5	20	57	113	13	457	950	320	691
TFE08060	Ø8 x 60	60	8	60	100	12	50	10	20	57	113	13	457	950	320	691
TFE08070	Ø8 x 70	70	8	75	100	12	65	5	20	76	152	13	857	950	600	762
TFE08080	Ø8 x 80	80	8	75	100	12	65	15	20	76	152	13	857	950	600	762
TFE08090	Ø8 x 90	90	8	75	100	12	65	25	20	76	152	13	857	950	600	762
TFE08100	Ø8 x 100	100	8	75	100	12	65	35	20	76	152	13	857	950	600	762
TFE08110	Ø8 x 110	110	8	75	100	12	65	45	20	76	152	13	857	950	600	762
TFE08120	Ø8 x 120	120	8	75	100	12	65	55	20	76	152	13	857	950	600	762
TFE08140	Ø8 x 140	140	8	75	100	12	65	75	20	76	152	13	857	950	600	762
TFE10060	Ø10 x 60	60	10	65	100	14	55	5	30	63	125	15	638	1245	447	871
TFE10070	Ø10 x 70	70	10	65	100	14	55	15	30	63	125	15	638	1245	447	871
TFE10080	Ø10 x 80	80	10	85	120	14	75	25	30	88	176	15	638	1245	447	871
TFE10090	Ø10 x 90	90	10	95	135	14	85	5	30	101	201	15	1310	1330	917	1330
TFE10100	Ø10 x 100	100	10	95	135	14	85	15	30	101	201	15	1310	1330	917	1330
TFE10120	Ø10 x 120	120	10	95	135	14	85	35	30	101	201	15	1310	1330	917	1330
TFE10140	Ø10 x 140	140	10	95	135	14	85	55	30	101	201	15	1310	1330	917	1330
TFE12080	Ø12 x 80	80	12	90	120	16	75	5	50	87	174	18	1055	1808	738	1720
TFE12090	Ø12 x 90	90	12	90	120	16	75	15	50	87	174	18	1055	1808	738	1720
TFE12110	Ø12 x 110	110	12	120	170	16	105	5	50	126	251	18	1822	1808	1275	1808
TFE12130	Ø12 x 130	130	12	120	170	16	105	25	50	126	251	18	1822	1808	1275	1808
TFE12150	Ø12 x 150	150	12	120	170	16	105	45	50	126	251	18	1822	1808	1275	1808
TFE14080	Ø14 x 80	80	14	90	120	18	75	5	70	87	174	21	1055	2559	738	1883
TFE14100	Ø14 x 100	100	14	90	120	18	75	25	70	87	174	21	1055	2559	738	1883
TFE14120	Ø14 x 120	120	14	130	185	18	115	5	70	138	276	21	2107	2559	1475	2559
TFE14130	Ø14 x 130	130	14	130	185	18	115	15	70	138	276	21	2107	2559	1475	2559
TFE14140	Ø14 x 140	140	14	130	185	18	115	25	70	138	276	21	2107	2559	1475	2559
TFE14160	Ø14 x 160	160	14	130	185	18	115	45	70	138	276	21	2107	2559	1475	2559
TFE16100	Ø16 x 100	100	-	-	-	-	-	-	-	-	-	-	-	-	-	-
TFE16150	Ø16 x 150	150	-	-	-	-	-	-	-	-	-	-	-	-	-	-
TFE18100	Ø18 x 100	100	18	110	140	22	90	10	90	105	209	24	1384	3680	968	2576
TFE18130	Ø18 x 130	130	18	110	140	22	90	40	90	105	209	24	1384	3680	968	2576
TFE18160	Ø18 x 160	160	18	160	225	22	140	20	90	168	336	24	2830	3921	1981	3921
TFE18180	Ø18 x 180	180	18	160	225	22	140	40	90	168	336	24	2830	3921	1981	3921
TFE18200	Ø18 x 200	200	18	160	225	22	140	60	90	168	336	24	2830	3921	1981	3921

TFN Homologado ETE Opt.1. Cabeza hexagonal con recubrimiento cincado y sin arandela																
CÓDIGO	MXL	LONGITUD	Ø BROCA	PROFUNDIDAD MÍN. DE TALADRO	MÍN. ESPESOR MATERIAL BASE	Ø ELEMENTO A FIJAR	PROFUNDIDAD MÍN. DEL ANCLAJE	ESPEJOR MÁX. A FIJAR	PAR DE APRIETE (NM)	DISTANCIA MÍN. AL BORDE "A"	DISTANCIA MÍN. ENTRE EJES "B"	LLAVE DE INSTALACIÓN	EXTRACCIÓN HORMIGÓN NO-FISURADO	CIZALLADURA HORMIGÓN NO-FISURADO	EXTRACCIÓN HORMIGÓN FISURADO	CIZALLADURA HORMIGÓN FISURADO
TFN14080	Ø14 x 80	80	14	90	120	18	75	5	70	87	174	24	1055	2559	738	1883

TFS Homologado ETE Opt.1. Espárrago cincado																
CÓDIGO	MXL	LONGITUD	Ø BROCA	PROFUNDIDAD MÍN. DE TALADRO	MÍN. ESPESOR MATERIAL BASE	Ø ELEMENTO A FIJAR	PROFUNDIDAD MÍN. DEL ANCLAJE	ESPEJOR MÁX. A FIJAR	PAR DE APRIETE (NM)	DISTANCIA MÍN. AL BORDE "A"	DISTANCIA MÍN. ENTRE EJES "B"	LLAVE DE INSTALACIÓN	EXTRACCIÓN HORMIGÓN NO-FISURADO	CIZALLADURA HORMIGÓN NO-FISURADO	EXTRACCIÓN HORMIGÓN FISURADO	CIZALLADURA HORMIGÓN FISURADO
TFS06100	Ø6 x 100	100	6	65	100	9	55	35	10	65	129	5	673	608	471	542
TFS06120	Ø6 x 120	120	6	65	100	9	55	55	10	65	129	5	673	608	471	542
TFS08110	Ø8 x 110	110	8	75	100	12	65	32	20	76	152	7	857	950	600	762
TFS08130	Ø8 x 130	130	8	75	100	12	65	52	20	76	152	7	857	950	600	762
TFS10120	Ø10 x 120	120	10	85	120	14	75	27	30	88	176	8	1068	1330	748	987
TFS10140	Ø10 x 140	140	10	85	120	14	75	47	30	88	176	8	1068	1330	748	987

TFF Homologado ETE Opt.1. Rosca hembra métrica cincada																
CÓDIGO	MXL	LONGITUD	Ø BROCA	PROFUNDIDAD MÍN. DE TALADRO	MÍN. ESPESOR MATERIAL BASE	Ø ELEMENTO A FIJAR	PROFUNDIDAD MÍN. DEL ANCLAJE	PAR DE APRIETE (NM)	DISTANCIA MÍN. AL BORDE "A"	DISTANCIA MÍN. ENTRE EJES "B"	LLAVE DE INSTALACIÓN	EXTRACCIÓN HORMIGÓN NO-FISURADO	CIZALLADURA HORMIGÓN NO-FISURADO	EXTRACCIÓN HORMIGÓN FISURADO	CIZALLADURA HORMIGÓN FISURADO	
TFF06035	Ø6 x 35	35	6	45	100	--	35	10	39	78	13	202	608	185	454	
TFF06055	Ø6 x 55	55	6	55	100	--	55	10	65	129	13	673	608	471	542	

TFM Homologado ETE Opt.1. Rosca macho métrica cincado																
CÓDIGO	MXL	LONGITUD	Ø BROCA	PROFUNDIDAD MÍN. DE TALADRO	MÍN. ESPESOR MATERIAL BASE	Ø ELEMENTO A FIJAR	PROFUNDIDAD MÍN. DEL ANCLAJE	PAR DE APRIETE (NM)	DISTANCIA MÍN. AL BORDE "A"	DISTANCIA MÍN. ENTRE EJES "B"	LLAVE DE INSTALACIÓN	EXTRACCIÓN HORMIGÓN NO-FISURADO	CIZALLADURA HORMIGÓN NO-FISURADO	EXTRACCIÓN HORMIGÓN FISURADO	CIZALLADURA HORMIGÓN FISURADO	
TFM06035	Ø6 x 35	35	6	45	100	--	35	10	39	78	13	202	608	185	454	
TFM06055	Ø6 x 55	55	6	55	100	--	55	10	65	129	13	673	608	471	542	

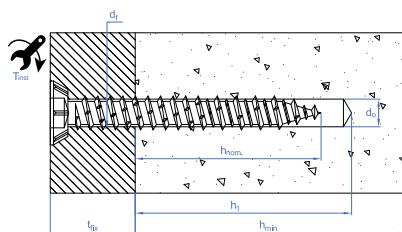

HP / HPZ

Cabeza plana, TX, Bicromatado

CÓDIGO	MXL	ESPOSOR MÁX. A FIJAR	Ø BROCA	PROFUNDIDAD MÍN. DE TALADRO	PROFUNDIDAD MÍN. DEL ANCLAJE	LLAVE DE INSTALACIÓN	PAR DE APRIETE (NM)	Ø ELEMENTO A FIJAR	MÍN. ESPESOR MATERIAL BASE	EXTRACCIÓN HORMIGÓN NO-FISURADO	CIZALLADURA HORMIGÓN NO-FISURADO
HP75072	7,5 x 72	32	6	45	40	TX30	20	9	100	100	-
HP75092	7,5 x 92	52	6	45	40	TX30	20	9	100	100	-
HP75112	7,5 x 112	72	6	45	40	TX30	20	9	100	100	-
HP75132	7,5 x 132	92	6	45	40	TX30	20	9	100	100	-
HP75152	7,5 x 152	112	6	45	40	TX30	20	9	100	100	-
HP75182	7,5 x 182	142	6	45	40	TX30	20	9	100	100	-
HPZ75072	7,5 x 72	32	6	45	40	TX30	20	9	100	100	-
HPZ75092	7,5 x 92	52	6	45	40	TX30	20	9	100	100	-
HPZ75112	7,5 x 112	72	6	45	40	TX30	20	9	100	100	-
HPZ75132	7,5 x 132	92	6	45	40	TX30	20	9	100	100	-
HPZ75152	7,5 x 152	112	6	45	40	TX30	20	9	100	100	-
HPZ75182	7,5 x 182	142	6	45	40	TX30	20	9	100	100	-
HPZ75212	7,5 x 212	172	6	45	40	TX30	20	9	100	100	-

HR

Cabeza cilíndrica, Tx

CÓDIGO	MXL	ESPOSOR MÁX. A FIJAR	Ø BROCA	PROFUNDIDAD MÍN. DE TALADRO	PROFUNDIDAD MÍN. DEL ANCLAJE	LLAVE DE INSTALACIÓN	PAR DE APRIETE (NM)	Ø ELEMENTO A FIJAR	MÍN. ESPESOR MATERIAL BASE	DISTANCIA MÍN. AL BORDE "A"	DISTANCIA MÍN. ENTRE EJES "B"	EXTRACCIÓN HORMIGÓN NO-FISURADO	CIZALLADURA HORMIGÓN NO-FISURADO
HR75072	7,5 x 72	32	6	45	40	TX25	15	9	100	-	-	100	-
HR75092	7,5 x 92	52	6	45	40	TX25	15	9	100	-	-	100	-
HR75112	7,5 x 112	72	6	45	40	TX25	15	9	100	-	-	100	-
HR75132	7,5 x 132	92	6	45	40	TX25	15	9	100	-	-	100	-

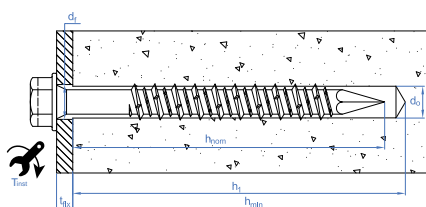

HEA

Tornillo con cabeza hexagonal

CÓDIGO	MXL	ESPOSOR MÁX. A FIJAR	Ø BROCA	PROFUNDIDAD MÍN. DE TALADRO	PROFUNDIDAD MÍN. DEL ANCLAJE	LLAVE DE INSTALACIÓN	PAR DE APRIETE (NM)	Ø ELEMENTO A FIJAR	MÍN. ESPESOR MATERIAL BASE	EXTRACCIÓN HORMIGÓN NO-FISURADO	CIZALLADURA HORMIGÓN NO-FISURADO
HE65032	6,5 x 32	2	5	35	30	8+ ranura	12	8	100	65	-
HE65045	6,5 x 45	15	5	35	30	8+ ranura	12	8	100	65	-
HE65057	6,5 x 57	27	5	35	30	8+ ranura	12	8	100	65	-
HE65070	6,5 x 70	40	5	35	30	8+ ranura	12	8	100	65	-
HE65080	6,5 x 80	50	5	35	30	8+ ranura	12	8	100	65	-
HE65100	6,5 x 100	70	5	35	30	8+ ranura	12	8	100	65	-
HE65115	6,5 x 115	85	5	35	30	8+ ranura	12	8	100	65	-
HE65125	6,5 x 125	95	5	35	30	8+ ranura	12	8	100	65	-
HE65150	6,5 X 150	120	5	35	30	8+ ranura	12	8	100	65	-
HE65180	6,5 X 180	150	5	35	30	8+ ranura	12	8	100	65	-
HE65200	6,5 X 200	170	5	35	30	8+ ranura	12	8	100	65	-
HE65230	6,5 X 230	200	5	35	30	8+ ranura	12	8	100	65	-

HEA + ARVUL Tornillo montado con arandela vulcanizada de acero-EPDM

CÓDIGO	MXL	ESPESOR MÁX. A FIJAR	Ø BROCA	PROFUNDIDAD MÍN. DE TALADRO	PROFUNDIDAD MÍN. DEL ANCLAJE	LLAVE DE INSTALACIÓN	PAR DE APRIETE (NM)	Ø ELEMENTO A FIJAR	MÍN. ESPESOR MATERIAL BASE	EXTRACCIÓN HORMIGÓN NO-FISURADO	CIZALLADURA HORMIGÓN NO-FISURADO
HE1665032	6,5 x 32	2	5	35	30	8+ ranura	12	8	100	65	-
HE1665045	6,5 x 45	15	5	35	30	8+ ranura	12	8	100	65	-
HE1665057	6,5 x 57	27	5	35	30	8+ ranura	12	8	100	65	-
HE1665070	6,5 x 70	40	5	35	30	8+ ranura	12	8	100	65	-
HE1665080	6,5 x 80	50	5	35	30	8+ ranura	12	8	100	65	-
HE1665100	6,5 x 100	70	5	35	30	8+ ranura	12	8	100	65	-
HE1665115	6,5 x 115	85	5	35	30	8+ ranura	12	8	100	65	-
HE1665125	6,5 x 125	95	5	35	30	8+ ranura	12	8	100	65	-
HE1665150	6,5 X 150	120	5	35	30	8+ ranura	12	8	100	65	-
HE1665180	6,5 X 180	150	5	35	30	8+ ranura	12	8	100	65	-
HE1665200	6,5 X 200	170	5	35	30	8+ ranura	12	8	100	65	-
HE1665230	6,5 X 230	200	5	35	30	8+ ranura	12	8	100	65	-

SL

Anclaje de seguridad para grandes cargas en hormigón

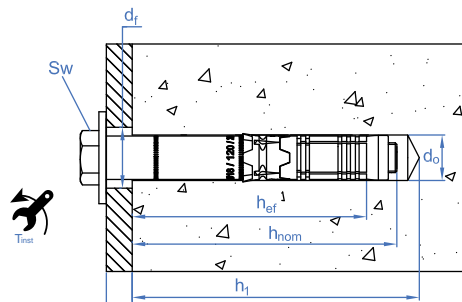

SL-PT Homologado ETE Opt.1. Cabeza hexagonal

CÓDIGO	MXL	ESPESOR MÁX. A FIJAR	Ø BROCA	PROFUNDIDAD MÍN. DE TALADRO	PROFUNDIDAD MÍN. DEL ANCLAJE	LLAVE DE INSTALACIÓN	PAR DE APRIETE (NM)	Ø ELEMENTO A FIJAR	MÍN. ESPESOR MATERIAL BASE	DISTANCIA MÍN. AL BORDE "A"	DISTANCIA MÍN. ENTRE EJES "B"	EXTRACCIÓN HORMIGÓN NO-FISURADO	CIZALLADURA HORMIGÓN NO-FISURADO	EXTRACCIÓN HORMIGÓN FISURADO	CIZALLADURA HORMIGÓN FISURADO
SLPT10070	M6 x 70	10	10	70	59	10	15	12	100	75	150	782	844	591	591
SLPT10080	M6 x 80	20	10	70	59	10	15	12	100	75	150	782	844	591	591
SLPT10100	M6x 100	40	10	70	59	10	15	12	100	75	150	782	844	591	591
SLPT10110	M6 x 110	50	10	70	59	10	15	12	100	75	150	782	844	591	591
SLPT12080	M8 x 80	5	12	85	72	13	30	14	120	90	180	1110	1922	777	1554
SLPT12090	M8 x 90	15	12	85	72	13	30	14	120	90	180	1110	1922	777	1554
SLPT12100	M8 x 100	25	12	85	72	13	30	14	120	90	180	1110	1922	777	1554
SLPT12120	M8 x 120	45	12	85	72	13	30	14	120	90	180	1110	1922	777	1554
SLPT16100	M10 x 100	15	16	95	83	17	50	18	140	105	210	1399	2797	979	1958
SLPT16120	M10 x 120	35	16	95	83	17	50	18	140	105	210	1399	2797	979	1958
SLPT16140	M10 x 140	55	16	95	83	17	50	18	140	105	210	1399	2797	979	1958
SLPT16160	M10 x 160	75	16	95	83	17	50	18	140	105	210	1399	2797	979	1958
SLPT18110	M12 x 110	10	18	110	97	19	80	20	170	130	255	1871	3743	1310	2620
SLPT18120	M12 x 120	20	18	110	97	19	80	20	170	130	255	1871	3743	1310	2620
SLPT18140	M12 x 140	40	18	110	97	19	80	20	170	130	255	1871	3743	1310	2620
SLPT18150	M12 x 150	50	18	110	97	19	80	20	170	130	255	1871	3743	1310	2620
SLPT18170	M12 x 170	70	18	110	97	19	80	20	170	130	255	1871	3743	1310	2620
SLPT18200	M12 x 200	100	18	110	97	19	80	20	170	130	255	1871	3743	1310	2620
SLPT24140	M16 x 140	20	24	130	117	24	160	26	200	150	300	1990	4776	1393	3343
SLPT24170	M16 x 170	50	24	130	117	24	160	26	200	150	300	1990	4776	1393	3343
SLPT24200	M16 x 200	80	24	130	117	24	160	26	200	150	300	1990	4776	1393	3343
SLPT24220	M16 x 220	100	24	130	117	24	160	26	200	150	300	1990	4776	1393	3343
SLPT28170	M20 x 170	20	28	160	146	30	240	31	250	190	375	2781	6674	1947	4672
SLPT28200	M20 x 200	50	28	160	146	30	240	31	250	190	375	2781	6674	1947	4672
SLPT28240	M20 x 240	90	28	160	146	30	240	31	250	190	375	2781	6674	1947	4672

SL-PC Homologado ETE Opt.1. Cabeza avellanada

CÓDIGO	MXL	ESPESOR MÁX. A FIJAR	Ø BROCA	PROFUNDIDAD MÍN. DE TALADRO	PROFUNDIDAD MÍN. DEL ANCLAJE	LLAVE DE INSTALACIÓN	PAR DE APRIETE (NM)	Ø ELEMENTO A FIJAR	MÍN. ESPESOR MATERIAL BASE	DISTANCIA MÍN. AL BORDE "A"	DISTANCIA MÍN. ENTRE EJES "B"	EXTRACCIÓN HORMIGÓN NO-FISURADO	CIZALLADURA HORMIGÓN NO-FISURADO	EXTRACCIÓN HORMIGÓN FISURADO	CIZALLADURA HORMIGÓN FISURADO
SLPC10070	M6 x 70	10	10	70	59	4	15	12	100	75	150	782	844	591	591
SLPC10080	M6 x 80	20	10	70	59	4	15	12	100	75	150	782	844	591	591
SLPC10100	M6 x 100	40	10	70	59	4	15	12	100	75	150	782	844	591	591
SLPC12100	M8 x 100	25	12	85	72	5	30	14	120	90	180	1110	1922	777	1554
SLPC16100	M10 x 100	15	16	95	83	6	50	18	140	105	210	1399	2797	979	1958
SLPC16120	M10 x 120	35	16	95	83	6	50	18	140	105	210	1399	2797	979	1958
SLPC18120	M12 x 120	20	18	110	97	8	80	20	170	130	255	1871	3743	1310	2620

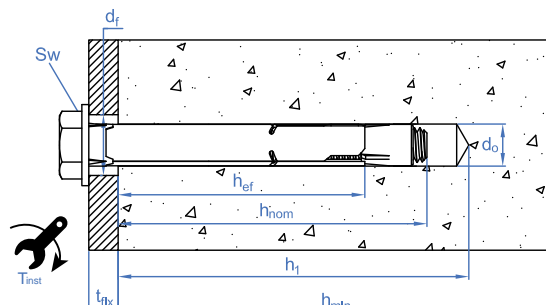

CH-TO

Tornillo hexagonal 6.8. Homologado ETE Opt.7

CÓDIGO	MXL	ESPESOR MÁX. A FIJAR	Ø BROCA	PROFUNDIDAD MÍN. DE TALADRO	PROFUNDIDAD MÍN. DEL ANCLAJE	LLAVE DE INSTALACIÓN	PAR DE APRIETE (NM)	Ø ELEMENTO A FIJAR	MÍN. ESPESOR MATERIAL BASE	DISTANCIA MÍN. AL BORDE "A"	DISTANCIA MÍN. ENTRE EJES "B"	EXTRACCIÓN HORMIGÓN NO-FISURADO	CIZALLADURA HORMIGÓN NO-FISURADO
ACHT08C	M6 x 45	5	8	45	39	10	10	9	100	41	41	267	351
ACHT08L	M6 x 60	20	8	45	39	10	10	9	100	41	41	267	351
ACHT09C	M6 x 45	5	9	45	39	10	10	10	100	41	41	267	351
ACHT09L	M6 x 60	20	9	45	39	10	10	10	100	41	41	267	351
ACHT10C	M8 x 60	5	10	60	51	13	20	12	100	54	54	485	604
ACHT10L	M8 x 80	27	10	60	51	13	20	12	100	54	54	485	604
ACHT11C	M8 x 60	5	11	60	51	13	20	13	100	54	54	485	604
ACHT11L	M8 x 80	27	11	60	51	13	20	13	100	54	54	485	604
ACHT12C	M10 x 70	5	12	75	65	17	35	14	100	65	65	662	794
ACHT12L	M10 x 100	32	12	75	65	17	35	14	100	65	65	662	794
ACHT14C	M10 x 70	5	14	75	65	17	35	16	100	65	65	662	794
ACHT14L	M10 x 100	32	14	75	65	17	35	16	100	65	65	662	794
ACHT16C	M12 x 80	5	16	80	70	19	50	18	110	74	74	812	974
ACHT16L	M12 x 110	37	16	80	70	19	50	18	110	74	74	812	974
ACHT20C	M16 x 110	15	20	105	92	24	140	22	145	97	97	1459	2744
ACHT25C	M20 x 130	25	25	130	102	30	240	27	160	120	240	1424	3417

CH-A2

Inoxidable A2. Homologado ETE Opt.7

CÓDIGO	MXL	ESPESOR MÁX. A FIJAR	Ø BROCA	PROFUNDIDAD MÍN. DE TALADRO	PROFUNDIDAD MÍN. DEL ANCLAJE	LLAVE DE INSTALACIÓN	PAR DE APRIETE (NM)	Ø ELEMENTO A FIJAR	MÍN. ESPESOR MATERIAL BASE	DISTANCIA MÍN. AL BORDE "A"	DISTANCIA MÍN. ENTRE EJES "B"	EXTRACCIÓN HORMIGÓN NO-FISURADO	CIZALLADURA HORMIGÓN NO-FISURADO
ACHTA208C	M6 x 45	5	8	45	39	10	10	9	100	41	41	392	329
ACHTA208L	M6 x 60	20	8	45	39	10	10	9	100	41	41	392	329
ACHTA209C	M6 x 45	5	9	45	39	10	10	10	100	41	41	392	329
ACHTA209L	M6 x 60	20	9	45	39	10	10	10	100	41	41	392	329
ACHTA210C	M8 x 60	5	10	60	51	13	20	12	100	54	54	384	600
ACHTA210L	M8 x 80	27	10	60	51	13	20	12	100	54	54	384	600
ACHTA211C	M8 x 60	5	11	60	51	13	20	13	100	54	54	384	600
ACHTA211L	M8 x 80	27	11	60	51	13	20	13	100	54	54	384	600
ACHTA212C	M10 x 70	5	12	75	65	17	35	14	100	65	65	566	794
ACHTA212L	M10 x 100	32	12	75	65	17	35	14	100	65	65	566	794
ACHTA214C	M10 x 70	5	14	75	65	17	35	16	100	65	65	566	794
ACHTA214L	M10 x 100	32	14	75	65	17	35	16	100	65	65	566	794
ACHTA216C	M12 x 80	5	16	80	70	19	50	18	110	74	74	647	974
ACHTA216L	M12 x 110	37	16	80	70	19	50	18	110	74	74	647	974
ACHTA220C	M16 x 110	15	20	105	92	24	140	22	145	97	97	971	2572

CH-8.8

Tornillo hexagonal 8.8. Homologado ETE Opt.7

CÓDIGO	MXL	ESPESOR MÁX. A FIJAR	Ø BROCA	PROFUNDIDAD MÍN. DE TALADRO	PROFUNDIDAD MÍN. DEL ANCLAJE	LLAVE DE INSTALACIÓN	PAR DE APRIETE (NM)	Ø ELEMENTO A FIJAR	MÍN. ESPESOR MATERIAL BASE	DISTANCIA MÍN. AL BORDE "A"	DISTANCIA MÍN. ENTRE EJES "B"	EXTRACCIÓN HORMIGÓN NO-FISURADO	CIZALLADURA HORMIGÓN NO-FISURADO
ACHT8808C	M6 x 45	5	8	45	39	10	10	9	100	41	41	267	392
ACHT8808L	M6 x 60	20	8	45	39	10	10	9	100	41	41	267	392
ACHT8810C	M8 x 60	5	10	60	51	13	20	12	100	54	54	485	604
ACHT8810L	M8 x 80	27	10	60	51	13	20	12	100	54	54	485	604
ACHT8812C	M10 x 70	5	12	75	65	17	35	14	100	65	65	662	794
ACHT8812L	M10 x 100	32	12	75	65	17	35	14	100	65	65	662	794
ACHT8816C	M12 x 80	5	16	80	70	19	50	18	110	74	74	812	974
ACHT8816L	M12 x 110	37	16	80	70	19	50	18	110	74	74	812	974
ACHT8820C	M16 x 110	15	20	105	92	24	140	22	145	97	97	1459	2918

CH-8.8 E

Tornillo hexagonal 8.8 para espesores reducidos

CÓDIGO	MXL	ESPESOR MÁX. A FIJAR	Ø BROCA	PROFUNDIDAD MÍN. DE TALADRO	PROFUNDIDAD MÍN. DEL ANCLAJE	LLAVE DE INSTALACIÓN	PAR DE APRIETE (NM)	Ø ELEMENTO A FIJAR	MÍN. ESPESOR MATERIAL BASE	DISTANCIA MÍN. AL BORDE "A"	DISTANCIA MÍN. ENTRE EJES "B"	EXTRACCIÓN HORMIGÓN NO- FISURADO	CIZALLADURA HORMIGÓN NO- FISURADO
ACHT8808E	M6 x 40	5	8	40	32	10	10	9	70	41	54	215	298
ACHT8810E	M8 x 40	5	10	45	37	13	20	12	70	41	54	249	298

CH-PL

Cabeza plana. Homologado ETE Opt.7. Homologado ETE Opción 7.

CÓDIGO	MXL	ESPESOR MÁX. A FIJAR	Ø BROCA	PROFUNDIDAD MÍN. DE TALADRO	PROFUNDIDAD MÍN. DEL ANCLAJE	LLAVE DE INSTALACIÓN	PAR DE APRIETE (NM)	Ø ELEMENTO A FIJAR	MÍN. ESPESOR MATERIAL BASE	DISTANCIA MÍN. AL BORDE "A"	DISTANCIA MÍN. ENTRE EJES "B"	EXTRACCIÓN HORMIGÓN NO- FISURADO	CIZALLADURA HORMIGÓN NO- FISURADO
ACHTPL08C	M6 x 45	5	8	45	39	4	10	9	100	41	41	267	392
ACHTPL08L	M6 x 60	20	8	45	39	4	10	9	100	41	41	267	392
ACHTPL10C	M8 x 60	5	10	60	51	5	20	12	100	54	54	485	604
ACHTPL10L	M8 x 80	27	10	60	51	5	20	12	100	54	54	485	604
ACHTPL12C	M10 x 70	5	12	75	65	6	35	14	100	65	65	662	794
ACHTPL12L	M10 x 100	32	12	75	65	6	35	14	100	65	65	662	794

CH-INB

Cabeza inviolable cincada. Homologado ETE Opt.7

CÓDIGO	MXL	ESPESOR MÁX. A FIJAR	Ø BROCA	PROFUNDIDAD MÍN. DE TALADRO	PROFUNDIDAD MÍN. DEL ANCLAJE	LLAVE DE INSTALACIÓN	PAR DE APRIETE (NM)	Ø ELEMENTO A FIJAR	MÍN. ESPESOR MATERIAL BASE	DISTANCIA MÍN. AL BORDE "A"	DISTANCIA MÍN. ENTRE EJES "B"	EXTRACCIÓN HORMIGÓN NO- FISURADO	CIZALLADURA HORMIGÓN NO- FISURADO
ACHINB08C	M6 x 45	5	8	45	39	TX40	10	9	100	41	41	267	219
ACHINB08L	M6 x 60	20	8	45	39	TX40	10	9	100	41	41	267	219
ACHINB10C	M8 x 60	5	10	60	51	TX40	20	12	100	54	54	485	399
ACHINB10L	M8 x 80	27	10	60	51	TX40	20	12	100	54	54	485	399

CH-INN

Cabeza inviolable cincada negra. Homologado ETE Opt.7

CÓDIGO	MXL	ESPESOR MÁX. A FIJAR	Ø BROCA	PROFUNDIDAD MÍN. DE TALADRO	PROFUNDIDAD MÍN. DEL ANCLAJE	LLAVE DE INSTALACIÓN	PAR DE APRIETE (NM)	Ø ELEMENTO A FIJAR	MÍN. ESPESOR MATERIAL BASE	DISTANCIA MÍN. AL BORDE "A"	DISTANCIA MÍN. ENTRE EJES "B"	EXTRACCIÓN HORMIGÓN NO- FISURADO	CIZALLADURA HORMIGÓN NO- FISURADO
ACHINN08C	M6 x 45	5	8	45	39	TX40	10	9	100	41	41	267	219
ACHINN08L	M6 x 60	20	8	45	39	TX40	10	9	100	41	41	267	219
ACHINN10C	M8 x 60	5	10	60	51	TX40	20	12	100	54	54	485	399
ACHINN10L	M8 x 80	27	10	60	51	TX40	20	12	100	54	54	485	399

CH-PI

Cabeza plana inoxidable A2. Homologado ETE Opt.7

CÓDIGO	MXL	ESPESOR MÁX. A FIJAR	Ø BROCA	PROFUNDIDAD MÍN. DE TALADRO	PROFUNDIDAD MÍN. DEL ANCLAJE	LLAVE DE INSTALACIÓN	PAR DE APRIETE (NM)	Ø ELEMENTO A FIJAR	MÍN. ESPESOR MATERIAL BASE	DISTANCIA MÍN. AL BORDE "A"	DISTANCIA MÍN. ENTRE EJES "B"	EXTRACCIÓN HORMIGÓN NO- FISURADO	CIZALLADURA HORMIGÓN NO- FISURADO
ACHTPI08C	M6 x 45	5	8	45	39	4	10	9	100	41	41	392	329
ACHTPI08L	M6 x 60	20	8	45	39	4	10	9	100	41	41	392	329
ACHTPI10C	M8 x 60	5	10	60	51	5	20	12	100	54	54	384	600
ACHTPI10L	M8 x 80	27	10	60	51	5	20	12	100	54	54	384	600
ACHTPI12C	M10 x 70	5	12	75	65	6	35	14	100	65	65	566	794
ACHTPI12L	M10 x 100	32	12	75	65	6	35	14	100	65	65	566	794

CH-ES

Espárrago

CÓDIGO	MXL	ESPESOR MÁX. A FIJAR	Ø BROCA	PROFUNDIDAD MÍN. DE TALADRO	PROFUNDIDAD MÍN. DEL ANCLAJE	LLAVE DE INSTALACIÓN	PAR DE APRIETE (NM)	Ø ELEMENTO A FIJAR	MÍN. ESPESOR MATERIAL BASE	DISTANCIA MÍN. AL BORDE "A"	DISTANCIA MÍN. ENTRE EJES "B"	EXTRACCIÓN HORMIGÓN NO- FISURADO	CIZALLADURA HORMIGÓN NO- FISURADO
ACHE08C	M6 x 45	5	8	45	39	10	10	9	100	41	41	267	211
ACHE09C	M6 x 45	5	9	45	39	10	10	10	100	41	41	267	211
ACHE10C	M8 x 60	5	10	60	51	13	20	12	100	54	54	485	384
ACHE10L	M8 x 80	27	10	60	51	13	20	12	105	54	54	485	384
ACHE11C	M8 x 60	5	11	60	51	13	20	13	100	54	54	485	384
ACHE11L	M8 x 80	27	11	60	51	13	20	13	105	54	54	485	384
ACHE12C	M10 x 70	5	12	75	65	17	35	14	100	65	65	662	608
ACHE12L	M10 x 100	32	12	75	65	17	35	14	110	65	65	662	608
ACHE14C	M10 x 70	5	14	75	65	17	35	16	100	65	65	662	608
ACHE14L	M10 x 100	32	14	75	65	17	35	16	100	65	65	662	608

CH-GA

Gancho

CÓDIGO	MXL	ABERTURA GANCHO	Ø BROCA	PROFUNDIDAD MÍN. DE TALADRO	PROFUNDIDAD MÍN. DEL ANCLAJE	LLAVE DE INSTALACIÓN	PAR DE APRIETE (NM)	Ø ELEMENTO A FIJAR	MÍN. ESPESOR MATERIAL BASE	DISTANCIA MÍN. AL BORDE "A"	DISTANCIA MÍN. ENTRE EJES "B"	EXTRACCIÓN HORMIGÓN NO- FISURADO	CIZALLADURA HORMIGÓN NO- FISURADO
ACHG08C	M6 x 45	10	8	45	39	10	10	9	100	41	41	73	-
ACHG09C	M6 x 45	10	9	45	39	10	10	10	100	41	41	73	-
ACHG10C	M8 x 60	13	10	60	51	13	20	12	100	54	54	146	-
ACHG11C	M8 x 60	13	11	60	51	13	20	13	100	54	54	146	-
ACHG12C	M10 x 70	14	12	75	65	17	35	14	100	65	65	243	-
ACHG14C	M10 x 70	14	14	75	65	17	35	16	100	65	65	243	-
ACHG16C	M12 x 80	22	16	80	70	19	50	18	110	74	74	291	-

CH-GE

Gancho espiral

CÓDIGO	MXL	ESPESOR MÁX. A FIJAR	Ø BROCA	PROFUNDIDAD MÍN. DE TALADRO	PROFUNDIDAD MÍN. DEL ANCLAJE	LLAVE DE INSTALACIÓN	PAR DE APRIETE (NM)	Ø ELEMENTO A FIJAR	MÍN. ESPESOR MATERIAL BASE	DISTANCIA MÍN. AL BORDE "A"	DISTANCIA MÍN. ENTRE EJES "B"	EXTRACCIÓN HORMIGÓN NO-FISURADO	CIZALLADURA HORMIGÓN NO-FISURADO
ACHGE10	M8 x 115	-	10	60	51	13	20	12	100	41	41	146	-
ACHGE12	M10 x 135	-	12	80	70	17	35	14	100	54	54	243	-

CH-GF

Gancho forjado

CÓDIGO	MXL	ABERTURA GANCHO	Ø BROCA	PROFUNDIDAD MÍN. DE TALADRO	PROFUNDIDAD MÍN. DEL ANCLAJE	LLAVE DE INSTALACIÓN	PAR DE APRIETE (NM)	Ø ELEMENTO A FIJAR	MÍN. ESPESOR MATERIAL BASE	DISTANCIA MÍN. AL BORDE "A"	DISTANCIA MÍN. ENTRE EJES "B"	EXTRACCIÓN HORMIGÓN NO-FISURADO	CIZALLADURA HORMIGÓN NO-FISURADO
ACHGF008C	M6 x 45	10	8	45	39	10	10	9	100	41	41	80	-
ACHGF010C	M8 x 60	11	10	60	51	13	20	12	100	54	54	155	-
ACHGF012C	M10 x 70	14	12	75	65	17	35	14	100	65	65	243	-

CH-GF A2

Gancho forjado. Inoxidable A2

CÓDIGO	MXL	ABERTURA GANCHO	Ø BROCA	PROFUNDIDAD MÍN. DE TALADRO	PROFUNDIDAD MÍN. DEL ANCLAJE	LLAVE DE INSTALACIÓN	PAR DE APRIETE (NM)	Ø ELEMENTO A FIJAR	MÍN. ESPESOR MATERIAL BASE	DISTANCIA MÍN. AL BORDE "A"	DISTANCIA MÍN. ENTRE EJES "B"	EXTRACCIÓN HORMIGÓN NO-FISURADO	CIZALLADURA HORMIGÓN NO-FISURADO
ACHGA208C	M6 x 45	10	8	45	39	10	10	9	100	41	41	84	-
ACHGA210C	M8 x 60	11	10	60	51	13	20	12	100	54	54	84	-
ACHGA212C	M10 x 70	14	12	75	65	17	35	14	100	65	65	155	-

CH-AR

Argolla

CÓDIGO	MXL	Ø OJO	Ø BROCA	PROFUNDIDAD MÍN. DE TALADRO	PROFUNDIDAD MÍN. DEL ANCLAJE	LLAVE DE INSTALACIÓN	PAR DE APRIETE (NM)	Ø ELEMENTO A FIJAR	MÍN. ESPESOR MATERIAL BASE	DISTANCIA MÍN. AL BORDE "A"	DISTANCIA MÍN. ENTRE EJES "B"	EXTRACCIÓN HORMIGÓN NO-FISURADO	CIZALLADURA HORMIGÓN NO-FISURADO
ACHA08C	M6 x 45	10	8	45	39	10	10	9	100	41	41	73	-
ACHA09C	M6 x 45	10	9	45	39	10	10	10	100	41	41	73	-
ACHA10C	M8 x 60	13	10	60	51	13	20	12	100	54	54	146	-
ACHA11C	M8 x 60	13	11	60	51	13	20	13	100	54	54	146	-
ACHA12C	M10 x 70	14	12	75	65	17	35	14	100	65	65	243	-
ACHA14C	M10 x 70	14	14	75	65	17	35	16	100	65	65	243	-
ACHA16C	M12 x 80	22	16	80	70	19	50	18	110	74	74	291	-

CH-AF

Argolla forjada

CÓDIGO	MXL	Ø OJO	Ø BROCA	PROFUNDIDAD MÍN. DE TALADRO	PROFUNDIDAD MÍN. DEL ANCLAJE	LLAVE DE INSTALACIÓN	PAR DE APRIETE (NM)	Ø ELEMENTO A FIJAR	MÍN. ESPESOR MATERIAL BASE	DISTANCIA MÍN. AL BORDE "A"	DISTANCIA MÍN. ENTRE EJES "B"	EXTRACCIÓN HORMIGÓN NO-FISURADO	CIZALLADURA HORMIGÓN NO-FISURADO
ACHAF008C	M6 x 45	10	8	45	39	10	10	9	100	41	41	204	-
ACHAF010C	M8 x 60	12	10	60	51	13	20	12	100	54	54	485	-
ACHAF012C	M10 x 70	14	12	75	65	17	35	14	100	65	65	662	-

CH-AF A2

Argolla forjada inoxidable A2

CÓDIGO	MXL	Ø OJO	Ø BROCA	PROFUNDIDAD MÍN. DE TALADRO	PROFUNDIDAD MÍN. DEL ANCLAJE	LLAVE DE INSTALACIÓN	PAR DE APRIETE (NM)	Ø ELEMENTO A FIJAR	MÍN. ESPESOR MATERIAL BASE	DISTANCIA MÍN. AL BORDE "A"	DISTANCIA MÍN. ENTRE EJES "B"	EXTRACCIÓN HORMIGÓN NO-FISURADO	CIZALLADURA HORMIGÓN NO-FISURADO
ACHAA208C	M6 x 45	10	8	45	39	10	10	9	100	41	41	164	-
ACHAA210C	M8 x 60	11	10	60	51	13	20	12	100	54	54	384	-
ACHAA212C	M10 x 70	14	12	75	65	17	35	14	100	65	65	566	-

HE

Anclaje hembra con cono interior para grandes cargas

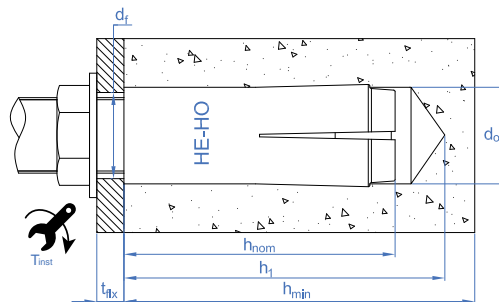

HE-HO

Homologado ETE Opción 7

CÓDIGO	MXL	Ø BROCA	PROFUNDIDAD MÍN. DE TALADRO	PROFUNDIDAD MÍN. DEL ANCLAJE	PAR DE APRIETE (NM)	Ø ELEMENTO A FIJAR	MÍN. ESPESOR MATERIAL BASE	DISTANCIA MÍN. AL BORDE "A"	DISTANCIA MÍN. ENTRE EJES "B"	EXTRACCIÓN HORMIGÓN NO-FISURADO	CIZALLADURA HORMIGÓN NO-FISURADO
HEHOM06	M6	8	27	25	4	7	100	38	75	249	298
HEHOM08	M8	10	33	30	11	9	100	45	90	327	392
HEHOM10	M10	12	43	40	17	12	100	60	120	432	530
HEHOM12	M12	15	54	50	38	14	100	75	150	603	844
HEHOM16	M16	20	70	65	60	18	130	98	195	894	1893
HEHOM20	M20	25	86	80	100	22	160	120	240	1220	2767
HEHOM12D	M12	16	54	50	38	14	100	75	150	603	844

HE-A4

Inoxidable A4. Homologado ETE Aplicaciones no estructurales

CÓDIGO	MXL	Ø BROCA	PROFUNDIDAD MÍN. DE TALADRO	PROFUNDIDAD MÍN. DEL ANCLAJE	PAR DE APRIETE (NM)	Ø ELEMENTO A FIJAR	MÍN. ESPESOR MATERIAL BASE	DISTANCIA MÍN. AL BORDE "A"	DISTANCIA MÍN. ENTRE EJES "B"	EXTRACCIÓN HORMIGÓN NO-FISURADO	CIZALLADURA HORMIGÓN NO-FISURADO
HEA4M06	M6	8	27	25	4	7	80	150	200	87	87
HEA4M08	M8	10	33	30	11	9	80	150	200	121	121
HEA4M10	M10	12	43	40	17	12	80	150	200	121	121
HEA4M12	M12	15	54	50	38	14	100	150	200	225	225
HEA4M16	M16	20	70	65	60	18	130	195	260	433	433
HEA4M20	M20	25	86	80	100	22	160	240	320	572	572

HE-CL

Con collarín. Cincado. Homologado ETE Opt.7 y para aplicaciones no estructurales

CÓDIGO	MXL	Ø BROCA	PROFUNDIDAD MÍN. DE TALADRO	PROFUNDIDAD MÍN. DEL ANCLAJE	PAR DE APRIETE (NM)	Ø ELEMENTO A FIJAR	MÍN. ESPESOR MATERIAL BASE	DISTANCIA MÍN. AL BORDE "A"	DISTANCIA MÍN. ENTRE EJES "B"	EXTRACCIÓN HORMIGÓN NO-FISURADO	CIZALLADURA HORMIGÓN NO-FISURADO
HECLOM06	M6	8	27	25	4	7	100	38	75	249	298
HECLOM08	M8	10	33	30	11	9	100	45	90	327	392
HECLOM10	M10	12	43	40	17	12	100	60	120	432	530
HECLOM12	M12	15	54	50	38	14	100	75	150	603	844
HECLOM16	M16	20	70	65	60	18	130	98	195	894	1893
HECLOM12D	M12	16	54	50	38	14	100	75	150	603	844

HE-C4

Con collarín. Inoxidable A4. Homologado ETE Aplicaciones no estructurales

CÓDIGO	MXL	Ø BROCA	PROFUNDIDAD MÍN. DE TALADRO	PROFUNDIDAD MÍN. DEL ANCLAJE	PAR DE APRIETE (NM)	Ø ELEMENTO A FIJAR	MÍN. ESPESOR MATERIAL BASE	DISTANCIA MÍN. AL BORDE "A"	DISTANCIA MÍN. ENTRE EJES "B"	EXTRACCIÓN HORMIGÓN NO-FISURADO	CIZALLADURA HORMIGÓN NO-FISURADO
HEC4M06	M6	8	27	25	4	7	80	150	200	87	87
HEC4M08	M8	10	33	30	11	9	80	150	200	121	121
HEC4M10	M10	12	43	40	17	12	80	150	200	121	121
HEC4M12	M12	15	54	50	38	14	100	150	200	225	225

HE-HC

Versión corta. Cincado. Homologado ETE Aplicaciones no estructurales

CÓDIGO	MXL	Ø BROCA	PROFUNDIDAD MÍN. DE TALADRO	PROFUNDIDAD MÍN. DEL ANCLAJE	PAR DE APRIETE (NM)	Ø ELEMENTO A FIJAR	MÍN. ESPESOR MATERIAL BASE	DISTANCIA MÍN. AL BORDE "A"	DISTANCIA MÍN. ENTRE EJES "B"	EXTRACCIÓN HORMIGÓN NO-FISURADO	CIZALLADURA HORMIGÓN NO-FISURADO
HEHCM08	M8 x 25	10	28	25	11	9	80	60	120	101	101
HEHCM10	M10 x 25	12	28	25	17	12	80	60	120	162	162
HEHCM12	M12 x 25	15	29	25	38	14	80	60	120	162	162

HE-NO

Cincado

CÓDIGO	MXL	Ø BROCA	PROFUNDIDAD MÍN. DE TALADRO	PROFUNDIDAD MÍN. DEL ANCLAJE	PAR DE APRIETE (NM)	Ø ELEMENTO A FIJAR	MÍN. ESPESOR MATERIAL BASE	DISTANCIA MÍN. AL BORDE "A"	DISTANCIA MÍN. ENTRE EJES "B"	EXTRACCIÓN HORMIGÓN NO-FISURADO	CIZALLADURA HORMIGÓN NO-FISURADO
HENOM06	M6	8	27	25	4	7	100	38	75	175	298
HENOM08	M8	10	33	30	11	9	100	45	90	230	392
HENOM10	M10	12	43	40	17	12	100	60	120	354	530
HENOM12	M12	15	54	50	38	14	100	75	150	494	844
HENOM16	M16	20	70	65	60	18	130	98	195	733	1893
HENOM20	M20	25	86	80	100	22	160	120	240	1000	2767

HE-NS

Inoxidable A4. Homologado ETE Aplicaciones no estructurales

CÓDIGO	MXL	Ø BROCA	PROFUNDIDAD MÍN. DE TALADRO	PROFUNDIDAD MÍN. DEL ANCLAJE	PAR DE APRIETE (NM)	Ø ELEMENTO A FIJAR	MÍN. ESPESOR MATERIAL BASE	DISTANCIA MÍN. AL BORDE "A"	DISTANCIA MÍN. ENTRE EJES "B"	EXTRACCIÓN HORMIGÓN NO-FISURADO	CIZALLADURA HORMIGÓN NO-FISURADO
HENSM08	M8 x 30	10	33	30	11	9	100	45	90	327	392
HENSM10	M10 x 40	12	43	40	17	12	100	60	120	432	530
HENSM12	M12 x 50	15	54	50	38	14	100	75	150	603	844
HENSM16	M16 x 65	20	70	65	60	18	130	98	195	894	1893

HC

Anclaje para losa alveolar. Homologado ETE

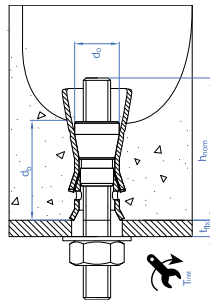

HC

Cápsula

CÓDIGO	MXL	Ø BROCA	PROFUNDIDAD MÍN. DE TALADRO	PAR DE APRIETE (NM)	Ø ELEMENTO A FIJAR	MÍN. ESPESOR MATERIAL BASE	DISTANCIA MÍN. AL BORDE "A"	DISTANCIA MÍN. ENTRE EJES "B"	EXTRACCIÓN HORMIGÓN NO-FISURADO	CIZALLADURA HORMIGÓN NO-FISURADO
HCM06	M6 x 38	10	45	10	7	25	100	200	142	142
HCM08	M8 x 44	12	50	20	9	25	100	200	243	243
HCM10	M10 x 53	16	60	30	12	25	100	200	324	324

TALA

Taco de latón para fijaciones ligeras en materiales macizos

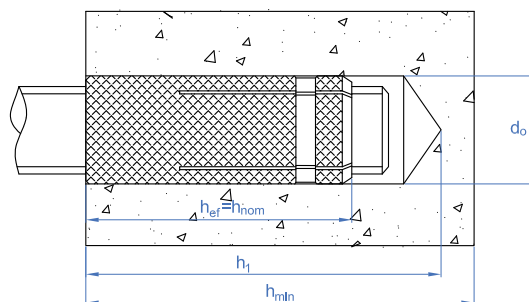

TALA

Taco de latón para fijaciones ligeras en materiales macizos

CÓDIGO	MXL	Ø BROCA	PROFUNDIDAD MÍN. DE TALADRO	MÍN. ESPESOR MATERIAL BASE	DISTANCIA MÍN. AL BORDE "A"	DISTANCIA MÍN. ENTRE EJES "B"	EXTRACCIÓN HORMIGÓN NO-FISURADO
TALA532	W5/32 x 16	5	20	25	24	48	60
TALAM04	M4 x 16	5	20	25	24	48	60
TALAM05	M5 x 18	6	22	30	27	54	70
TALAM06	M6 x 23	8	28	35	35	69	100
TALAM08	M8 x 28	10	33	40	42	84	150
TALAM10	M10 x 33	12	40	45	51	102	210
TALAM12	M12 x 38	15	45	50	57	114	320

TA-ME

Taco de expansión metálico

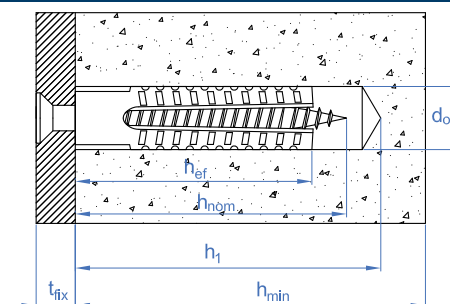

TA-ME

Taco de expansión metálico

CÓDIGO	MXL	Ø BROCA	PROFUNDIDAD MÍN. DE TALADRO	MÍN. ESPESOR MATERIAL BASE	DISTANCIA MÍN. AL BORDE "A"	DISTANCIA MÍN. ENTRE EJES "B"	EXTRACCIÓN HORMIGÓN NO-FISURADO
TAME05030	M5 x 30	5	40	60	60	120	20
TAME06032	M6 x 32	6	40	60	60	120	22
TAME08038	M8 x 38	8	50	70	70	140	40
TAME08060	M8 x 60	8	70	120	120	240	47
TAME10060	M10 x 60	10	70	120	120	240	52

AN-CU

Anclaje metálico tipo cuña. Homologado ETE

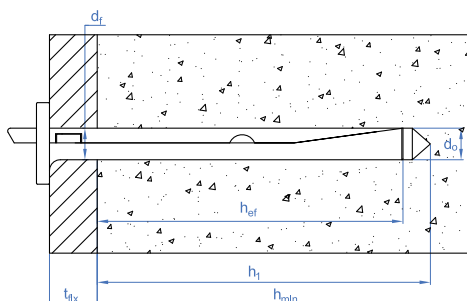

AN-CU

Anclaje metálico tipo cuña

CÓDIGO	MXL	ESPEJOR MÁX. A FIJAR	Ø BROCA	PROFUNDIDAD MÍN. DE TALADRO	Ø ELEMENTO A FIJAR	MÍN. ESPESOR MATERIAL BASE	DISTANCIA MÍN. AL BORDE "A"	DISTANCIA MÍN. ENTRE EJES "B"	EXTRACCIÓN HORMIGÓN NO-FISURADO
ANCU06040	6 x 40	5	6	40	7	80	150	200	120
ANCU06070	6 x 70	35	6	40	7	80	150	200	120

ZA

Anclaje para cargas medias-altas en materiales macizos o huecos

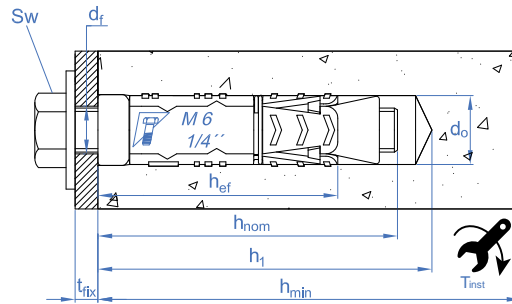

ZA-CA

Cápsula

CÓDIGO	MXL	ESPEJOR MÁX. A FIJAR	Ø BROCA	PROFUNDIDAD MÍN. DE TALADRO	PROFUNDIDAD MÍN. DEL ANCLAJE	PAR DE APRIETE (NM)	Ø ELEMENTO A FIJAR	MÍN. ESPESOR MATERIAL BASE	DISTANCIA MÍN. AL BORDE "A"	DISTANCIA MÍN. ENTRE EJES "B"	EXTRACCIÓN HORMIGÓN NO-FISURADO	CIZALLADURA HORMIGÓN NO-FISURADO
AZAMC06	M6 x 48	-	12	60	48	7	7	100	62	125	513	351
AZAMC08	M8 x 50	-	14	65	50	15	9	100	65	130	561	640
AZAMC10	M10 x 58	-	16	75	58	30	12	102	80	155	725	870
AZAMC12	M12 x 72	-	20	90	72	50	14	122	95	185	865	1473
AZAMC16	M16 x 107	-	25	125	107	120	18	192	145	290	1053	2744

ZA-TO

Tornillo

CÓDIGO	MXL	ESPEJOR MÁX. A FIJAR	Ø BROCA	PROFUNDIDAD MÍN. DE TALADRO	PROFUNDIDAD MÍN. DEL ANCLAJE	LLAVE DE INSTALACIÓN	PAR DE APRIETE (NM)	Ø ELEMENTO A FIJAR	MÍN. ESPESOR MATERIAL BASE	DISTANCIA MÍN. AL BORDE "A"	DISTANCIA MÍN. ENTRE EJES "B"	EXTRACCIÓN HORMIGÓN NO-FISURADO	CIZALLADURA HORMIGÓN NO-FISURADO
AZAMT06	M6 x 50	1	12	60	48	10	7	7	100	62	125	513	351
AZAMT08	M8 x 60	10	14	65	50	13	15	9	100	65	130	561	640
AZAMT10	M10 x 80	20	16	75	58	17	30	12	102	80	155	725	870
AZAMT12	M12 x 100	25	20	90	72	19	50	14	122	95	185	865	1473
AZAMT16	M16 x 140	30	25	125	107	24	120	18	192	145	290	1053	2744

ZA-TL

Tornillo largo

CÓDIGO	MXL	ESPEJOR MÁX. A FIJAR	Ø BROCA	PROFUNDIDAD MÍN. DE TALADRO	PROFUNDIDAD MÍN. DEL ANCLAJE	LLAVE DE INSTALACIÓN	PAR DE APRIETE (NM)	Ø ELEMENTO A FIJAR	MÍN. ESPESOR MATERIAL BASE	DISTANCIA MÍN. AL BORDE "A"	DISTANCIA MÍN. ENTRE EJES "B"	EXTRACCIÓN HORMIGÓN NO-FISURADO	CIZALLADURA HORMIGÓN NO-FISURADO
ZT06L10	M6 x 60	10	12	60	48	10	7	7	100	62	125	513	351
ZT06L30	M6 x 80	30	12	60	48	10	7	7	100	62	125	513	351
ZT08L15	M8 x 70	15	14	65	50	13	15	9	100	65	130	561	640
ZT08L35	M8 x 90	35	14	65	50	13	15	9	100	65	130	561	640
ZT08L45	M8 x 100	45	14	65	50	13	15	9	100	65	130	561	640
ZT10L10	M10 x 70	10	16	75	58	17	30	12	102	80	155	725	870
ZT10L30	M10 x 90	30	16	75	58	17	30	12	102	80	155	725	870
ZT10L50	M10 x 110	50	16	75	58	17	30	12	102	80	155	725	870
ZT10L80	M10 x 140	80	16	75	58	17	30	12	102	80	155	725	870
ZT12L15	M12 x 90	15	20	90	72	19	50	14	122	95	185	865	1473
ZT12L45	M12 x 120	45	20	90	72	19	50	14	122	95	185	865	1473
ZT12L65	M12 x 140	65	20	90	72	19	50	14	122	95	185	865	1473

ZA-PR

Tornillo largo + prolongador

CÓDIGO	MXL	ESPEJOR MÁX. A FIJAR	Ø BROCA	PROFUNDIDAD MÍN. DE TALADRO	PROFUNDIDAD MÍN. DEL ANCLAJE	LLAVE DE INSTALACIÓN	PAR DE APRIETE (NM)	Ø ELEMENTO A FIJAR	MÍN. ESPESOR MATERIAL BASE	DISTANCIA MÍN. AL BORDE "A"	DISTANCIA MÍN. ENTRE EJES "B"	EXTRACCIÓN HORMIGÓN NO-FISURADO	CIZALLADURA HORMIGÓN NO-FISURADO
ZP06C40	M6 x 90	40	12	60	48	10	7	14	100	62	125	415	246
ZP08C15	M8 x 70	15	14	65	50	13	7	16	100	65	130	561	448
ZP08C45	M8 x 100	45	14	65	50	13	30	16	100	80	130	561	448
ZP10C50	M10 x 110	50	16	75	58	17	30	18	102	80	155	725	709
ZP10C80	M10 x 140	80	16	75	58	17	30	18	102	80	155	725	709
ZP12C15	M12 x 90	15	20	90	72	19	50	22	122	95	185	865	1031
ZP12C65	M12 x 140	65	20	90	72	19	50	22	122	95	185	865	1031

ZA-ES

Espárrago

CÓDIGO	MXL	ESPEJOR MÁX. A FIJAR	Ø BROCA	PROFUNDIDAD MÍN. DE TALADRO	PROFUNDIDAD MÍN. DEL ANCLAJE	LLAVE DE INSTALACIÓN	PAR DE APRIETE (NM)	Ø ELEMENTO A FIJAR	MÍN. ESPESOR MATERIAL BASE	DISTANCIA MÍN. AL BORDE "A"	DISTANCIA MÍN. ENTRE EJES "B"	EXTRACCIÓN HORMIGÓN NO-FISURADO	CIZALLADURA HORMIGÓN NO-FISURADO
AZAME06	M6 x 60	1	12	60	48	10	7	7	100	62	125	415	246
AZAME08	M8 x 70	10	14	65	50	13	15	9	100	65	130	561	448
AZAME10	M10 x 100	30	16	75	58	17	30	12	102	80	155	725	709
AZAME12	M12 x 120	30	20	90	72	19	50	14	122	95	185	865	1031
AZAME16	M16 x 140	12	25	125	107	24	120	18	192	145	290	1053	1920

ZA-GA

Gancho

CÓDIGO	MXL	ABERTURA GANCHO	Ø BROCA	PROFUNDIDAD MÍN. DE TALADRO	PROFUNDIDAD MÍN. DEL ANCLAJE	LLAVE DE INSTALACIÓN	PAR DE APRIETE (NM)	Ø ELEMENTO A FIJAR	MÍN. ESPESOR MATERIAL BASE	DISTANCIA MÍN. AL BORDE "A"	DISTANCIA MÍN. ENTRE EJES "B"	EXTRACCIÓN HORMIGÓN NO-FISURADO	CIZALLADURA HORMIGÓN NO-FISURADO
AZAMG06	M6 x 48	10	12	60	48	10	7	7	100	62	125	73	-
AZAMG08	M8 x 50	13	14	65	50	13	15	9	100	65	130	146	-
AZAMG10	M10 x 58	14	16	75	58	17	30	12	102	80	155	243	-
AZAMG12	M12 x 72	22	20	90	72	19	50	14	122	95	185	291	-

ZA-GF

Gancho forjado

CÓDIGO	MXL	ABERTURA GANCHO	Ø BROCA	PROFUNDIDAD MÍN. DE TALADRO	PROFUNDIDAD MÍN. DEL ANCLAJE	LLAVE DE INSTALACIÓN	PAR DE APRIETE (NM)	Ø ELEMENTO A FIJAR	MÍN. ESPESOR MATERIAL BASE	DISTANCIA MÍN. AL BORDE "A"	DISTANCIA MÍN. ENTRE EJES "B"	EXTRACCIÓN HORMIGÓN NO-FISURADO	CIZALLADURA HORMIGÓN NO-FISURADO
AZAMGF006	M6 x 60	10	12	60	48	10	7	7	100	62	125	80	-
AZAMGF008	M8 x 70	11	14	65	50	13	15	9	100	65	130	155	-
AZAMGF010	M10 x 100	14	16	75	58	17	30	12	102	80	155	243	-
AZAMGF012	M12 x 120	18	20	90	72	19	50	14	122	95	185	396	-

ZA-AR

Argolla

CÓDIGO	MXL	Ø OJO	Ø BROCA	PROFUNDIDAD MÍN. DE TALADRO	PROFUNDIDAD MÍN. DEL ANCLAJE	LLAVE DE INSTALACIÓN	PAR DE APRIETE (NM)	Ø ELEMENTO A FIJAR	MÍN. ESPESOR MATERIAL BASE	DISTANCIA MÍN. AL BORDE "A"	DISTANCIA MÍN. ENTRE EJES "B"	EXTRACCIÓN HORMIGÓN NO-FISURADO	CIZALLADURA HORMIGÓN NO-FISURADO
AZAMA06	M6 x 48	10	12	60	48	10	7	7	100	62	125	73	-
AZAMA08	M8 x 50	13	14	65	50	13	15	9	100	65	130	146	-
AZAMA10	M10 x 58	14	16	75	58	17	30	12	102	80	155	243	-
AZAMA12	M12 x 72	22	20	90	72	19	50	14	122	95	185	291	-

ZA-AF

Argolla forjada

CÓDIGO	MXL	Ø OJO	Ø BROCA	PROFUNDIDAD MÍN. DE TALADRO	PROFUNDIDAD MÍN. DEL ANCLAJE	LLAVE DE INSTALACIÓN	PAR DE APRIETE (NM)	Ø ELEMENTO A FIJAR	MÍN. ESPESOR MATERIAL BASE	DISTANCIA MÍN. AL BORDE "A"	DISTANCIA MÍN. ENTRE EJES "B"	EXTRACCIÓN HORMIGÓN NO-FISURADO	CIZALLADURA HORMIGÓN NO-FISURADO
AZAMAF006	M6 x 48	10	12	60	48	10	7	7	100	62	125	204	-
AZAMAF008	M8 x 50	12	14	65	50	13	15	9	100	65	130	555	-
AZAMAF010	M10 x 58	14	16	75	58	17	30	12	102	80	155	725	-
AZAMAF012	M12 x 72	17	20	90	72	19	50	14	122	95	185	820	-

AC

Anclaje de acero con aletas para cargas altas

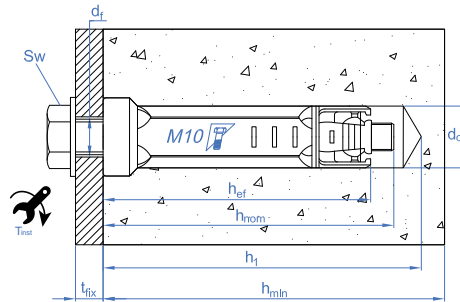

AC-CA

Cápsula

CÓDIGO	MXL	ESPEsor MÁX. A FIJAR	Ø BROCA	PROFUNDIDAD MÍN. DE TALADRO	PROFUNDIDAD MÍN. DEL ANCLAJE	PAR DE APRIETE (NM)	Ø ELEMENTO A FIJAR	MÍN. ESPESOR MATERIAL BASE	DISTANCIA MÍN. AL BORDE "A"	DISTANCIA MÍN. ENTRE EJES "B"	EXTRACCIÓN HORMIGÓN NO-FISURADO	CIZALLADURA HORMIGÓN NO-FISURADO
AACCA06	M6 x 40	-	10	45	40	10	7	100	60	120	92	351
AACCA08	M8 x 50	-	14	60	50	25	9	100	75	150	98	640
AACCA10	M10 x 60	-	16	70	60	50	12	120	90	180	441	1014
AACCA12	M12 x 80	-	20	90	80	85	14	160	120	240	571	1473
AACCA16	M16 x 100	-	25	110	100	120	18	200	150	300	698	2744

AC-CI

Cápsula. Inoxidable A4

CÓDIGO	MXL	ESPEsor MÁX. A FIJAR	Ø BROCA	PROFUNDIDAD MÍN. DE TALADRO	PROFUNDIDAD MÍN. DEL ANCLAJE	PAR DE APRIETE (NM)	Ø ELEMENTO A FIJAR	MÍN. ESPESOR MATERIAL BASE	DISTANCIA MÍN. AL BORDE "A"	DISTANCIA MÍN. ENTRE EJES "B"	EXTRACCIÓN HORMIGÓN NO-FISURADO	CIZALLADURA HORMIGÓN NO-FISURADO
AACCI06	M6 x 40	-	10	45	40	10	7	100	60	120	92	329
AACCI08	M8 x 50	-	14	60	50	25	9	100	75	150	98	600
AACCI10	M10 x 60	-	16	70	60	50	12	120	90	180	441	950
AACCI12	M12 x 80	-	20	90	80	85	14	160	120	240	571	1381

AC-TO

Tornillo 6.8

CÓDIGO	MXL	ESPEsor MÁX. A FIJAR	Ø BROCA	PROFUNDIDAD MÍN. DE TALADRO	PROFUNDIDAD MÍN. DEL ANCLAJE	LLAVE DE INSTALACIÓN	PAR DE APRIETE (NM)	Ø ELEMENTO A FIJAR	MÍN. ESPESOR MATERIAL BASE	DISTANCIA MÍN. AL BORDE "A"	DISTANCIA MÍN. ENTRE EJES "B"	EXTRACCIÓN HORMIGÓN NO-FISURADO	CIZALLADURA HORMIGÓN NO-FISURADO
AACTO06	M6 x 50	8	10	45	40	10	10	7	100	60	120	92	351
AACTO08	M8 x 60	8	14	60	50	13	25	9	100	75	150	98	640
AACTO10	M10 x 70	8	16	70	60	17	50	12	120	90	180	441	1014
AACTO12	M12 x 125	18	20	90	80	19	85	14	160	120	240	571	1473
AACTO16	M16 x 125	17	25	110	100	24	120	18	200	150	300	698	2744

AC-ES Espárrago													
CÓDIGO	MXL	ESPEJOR MÁX. A FIJAR	Ø BROCA	PROFUNDIDAD MÍN. DE TALADRO	PROFUNDIDAD MÍN. DEL ANCLAJE	LLAVE DE INSTALACIÓN	PAR DE APRIETE (NM)	Ø ELEMENTO A FIJAR	MÍN. ESPESOR MATERIAL BASE	DISTANCIA MÍN. AL BORDE "A"	DISTANCIA MÍN. ENTRE EJES "B"	EXTRACCIÓN HORMIGÓN NO-FISURADO	CIZALLADURA HORMIGÓN NO-FISURADO
AACES06	M6 x 60	8	10	45	40	10	10	7	100	60	120	92	246
AACES08	M8 x 70	8	14	60	50	13	25	9	100	75	150	98	448
AACES10	M10 x 80	8	16	70	60	17	50	12	120	90	180	441	709
AACES12	M12 x 115	18	20	90	80	19	85	14	160	120	240	571	1031

AC-GA Gancho													
CÓDIGO	MXL	ABERTURA GANCHO	Ø BROCA	PROFUNDIDAD MÍN. DE TALADRO	PROFUNDIDAD MÍN. DEL ANCLAJE	LLAVE DE INSTALACIÓN	PAR DE APRIETE (NM)	Ø ELEMENTO A FIJAR	MÍN. ESPESOR MATERIAL BASE	DISTANCIA MÍN. AL BORDE "A"	DISTANCIA MÍN. ENTRE EJES "B"	EXTRACCIÓN HORMIGÓN NO-FISURADO	CIZALLADURA HORMIGÓN NO-FISURADO
AACGA06	M6 x 55	10	10	45	40	10	10	7	100	60	120	80	-
AACGA08	M8 x 60	11	14	60	50	13	25	9	100	75	150	98	-
AACGA10	M10 x 73	14	16	70	60	17	50	12	120	90	180	243	-
AACGA12	M12 x 90	18	20	90	80	19	85	14	160	120	240	396	-

AC-AR Argolla													
CÓDIGO	MXL	Ø OJO	Ø BROCA	PROFUNDIDAD MÍN. DE TALADRO	PROFUNDIDAD MÍN. DEL ANCLAJE	LLAVE DE INSTALACIÓN	PAR DE APRIETE (NM)	Ø ELEMENTO A FIJAR	MÍN. ESPESOR MATERIAL BASE	DISTANCIA MÍN. AL BORDE "A"	DISTANCIA MÍN. ENTRE EJES "B"	EXTRACCIÓN HORMIGÓN NO-FISURADO	CIZALLADURA HORMIGÓN NO-FISURADO
AACAR06	M6 x 55	10	10	45	40	10	10	7	100	60	120	92	-
AACAR08	M8 x 60	12	14	60	50	13	25	9	100	75	150	98	-
AACAR10	M10 x 73	14	16	70	60	17	50	12	120	90	180	441	-
AACAR12	M12 x 90	17	20	90	80	19	85	14	160	120	240	571	-

HI Anclaje antigiro para cargas altas

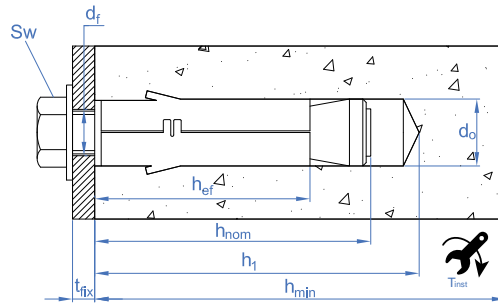

HI-CA Cápsula													
CÓDIGO	MXL	ESPEJOR MÁX. A FIJAR	Ø BROCA	PROFUNDIDAD MÍN. DE TALADRO	PROFUNDIDAD MÍN. DEL ANCLAJE	PAR DE APRIETE (NM)	Ø ELEMENTO A FIJAR	MÍN. ESPESOR MATERIAL BASE	DISTANCIA MÍN. AL BORDE "A"	DISTANCIA MÍN. ENTRE EJES "B"	EXTRACCIÓN HORMIGÓN NO-FISURADO	CIZALLADURA HORMIGÓN NO-FISURADO	
AHICA0645	M6 x 45	-	12	60	45	10	7	100	45	90	41	392	
AHICA0855	M8 x 55	-	14	65	50	20	9	100	55	105	163	494	
AHICA1065	M10 x 65	-	16	75	60	40	12	100	70	135	237	721	
AHICA1275	M12 x 75	-	20	90	70	65	14	110	85	165	332	1841	
AHICA1690	M16 x 90	-	24	105	100	150	18	140	105	210	424	2797	

HI-CI Cápsula. Inoxidable A2													
CÓDIGO	MXL	ESPEJOR MÁX. A FIJAR	Ø BROCA	PROFUNDIDAD MÍN. DE TALADRO	PROFUNDIDAD MÍN. DEL ANCLAJE	PAR DE APRIETE (NM)	Ø ELEMENTO A FIJAR	MÍN. ESPESOR MATERIAL BASE	DISTANCIA MÍN. AL BORDE "A"	DISTANCIA MÍN. ENTRE EJES "B"	EXTRACCIÓN HORMIGÓN NO-FISURADO	CIZALLADURA HORMIGÓN NO-FISURADO	
AHICIO645	M6 x 60	-	12	60	45	10	7	100	45	90	360	329	
AHICIO855	M8 x 65	-	14	65	50	20	9	100	55	105	542	600	
AHICIO65	M10 x 81	-	16	75	60	40	12	100	70	135	704	844	

HI-TO Tornillo 8.8													
CÓDIGO	MXL	ESPEJOR MÁX. A FIJAR	Ø BROCA	PROFUNDIDAD MÍN. DE TALADRO	PROFUNDIDAD MÍN. DEL ANCLAJE	LLAVE DE INSTALACIÓN	PAR DE APRIETE (NM)	Ø ELEMENTO A FIJAR	MÍN. ESPESOR MATERIAL BASE	DISTANCIA MÍN. AL BORDE "A"	DISTANCIA MÍN. ENTRE EJES "B"	EXTRACCIÓN HORMIGÓN NO-FISURADO	CIZALLADURA HORMIGÓN NO-FISURADO
AHITO0645	M6 x 50	8	12	60	45	10	10	7	100	45	90	41	392
AHITO0855	M8 x 60	15	14	65	50	13	20	9	100	55	105	163	494
AHITO1065	M10 x 80	23	16	75	60	17	40	12	100	70	135	237	721
AHITO1275	M12 x 100	30	20	90	70	19	65	14	110	85	165	332	1841
AHITO1690	M16 x 110	17	24	105	100	24	150	18	140	105	210	424	2797

HI-GA Gancho													
CÓDIGO	MXL	ABERTURA GANCHO	Ø BROCA	PROFUNDIDAD MÍN. DE TALADRO	PROFUNDIDAD MÍN. DEL ANCLAJE	LLAVE DE INSTALACIÓN	PAR DE APRIETE (NM)	MÍN. ESPESOR MATERIAL BASE	DISTANCIA MÍN. AL BORDE "A"	DISTANCIA MÍN. ENTRE EJES "B"	EXTRACCIÓN HORMIGÓN NO-FISURADO	CIZALLADURA HORMIGÓN NO-FISURADO	
AHIGA0645	M6 x 55	10	12	60	45	10	10	100	45	90	41	-	
AHIGA0855	M8 x 60	11	14	65	50	13	20	100	55	105	155	-	
AHIGA1065	M10 x 73	14	16	75	60	17	40	100	70	135	237	-	
AHIGA1275	M12 x 90	18	20	90	70	19	65	110	85	165	332	-	
AHIGA1690	M16 x 110	19	24	105	100	24	150	140	105	210	424	-	

HI-AR

Argolla

CÓDIGO	MXL	Ø OJO	Ø BROCA	PROFUNDIDAD MIN. DE TALADRO	PROFUNDIDAD MIN. DEL ANCLAJE	LLAVE DE INSTALACIÓN	PAR DE APRIETE (NM)	MÍN. ESPESOR MATERIAL BASE	DISTANCIA MIN. AL BORDE "A"	DISTANCIA MIN. ENTRE EJES "B"	EXTRACCIÓN HORMIGÓN NO-FISURADO	CIZALLADURA HORMIGÓN NO-FISURADO
AHIAR0645	M6 x 60	10	12	60	45	10	10	100	45	90	41	-
AHIAR0855	M8 x 65	12	14	65	50	13	20	100	55	105	163	-
AHIAR1065	M10 x 81	14	16	75	60	17	40	100	70	135	237	-
AHIAR1275	M12 x 98	17	20	90	70	19	65	110	85	165	332	-
AHIAR1690	M16 x 120	23	24	105	100	24	150	140	105	210	424	-

EPS

Anclaje metálico para fijar marcos de puertas y ventanas

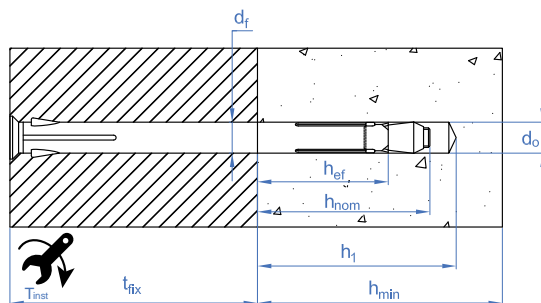

EPS

Anclaje metálico para fijar marcos de puertas y ventanas

CÓDIGO	MXL	ESPEJOR MÁX. A FIJAR	Ø BROCA	PROFUNDIDAD MIN. DE TALADRO	PROFUNDIDAD MIN. DEL ANCLAJE	PAR DE APRIETE (NM)	Ø ELEMENTO A FIJAR	MÍN. ESPESOR MATERIAL BASE	EXTRACCIÓN HORMIGÓN NO-FISURADO	CIZALLADURA HORMIGÓN FISURADO
EPS6072	M6 x 72	40	10	60	40	4	10	70	170	-
EPS6092	M6 x 92	60	10	60	40	4	10	70	170	-
EPS6112	M6 x 112	80	10	60	40	4	10	70	170	-
EPS6132	M6 x 132	100	10	60	40	4	10	70	170	-
EPS6152	M6 x 152	120	10	60	40	4	10	70	170	-
EPS6182	M6 x 182	150	10	60	40	4	10	70	170	-

TRA

Taco elástico para la fijación de rastreles

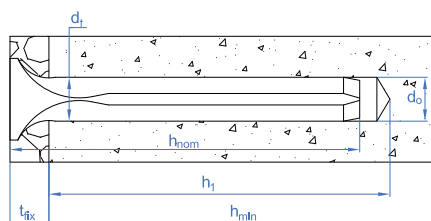

TRA

Taco elástico para la fijación de rastreles

CÓDIGO	MXL	ESPEJOR MÁX. A FIJAR	Ø BROCA	PROFUNDIDAD MIN. DE TALADRO	PROFUNDIDAD MIN. DEL ANCLAJE	Ø ELEMENTO A FIJAR	MÍN. ESPESOR MATERIAL BASE	EXTRACCIÓN HORMIGÓN NO-FISURADO	CIZALLADURA HORMIGÓN FISURADO
TRA6050	6 x 50	20	6	40	30	6	35	40	-
TRA6060	6 x 60	30	6	40	30	6	35	40	-
TRA6080	6 x 80	50	6	40	30	6	35	40	-
TRA8070	8 x 70	30	8	50	40	8	45	50	-
TRA8090	8 x 90	50	8	50	40	8	45	50	-
TRA8110	8 x 110	70	8	50	40	8	45	50	-
TRA8130	8 x 130	90	8	50	40	8	45	50	-
TRA8150	8 x 150	110	8	50	40	8	45	50	-

INSTALACIÓN EN HORMIGÓN

1 TALADRAR

Comprobar que:

- El hormigón esté bien compactado y sin poros significativos.
- El producto sea admisible en taladros secos, húmedos o inundados.
- La temperatura de los cartuchos sea la adecuada (revisar tabla).
- La temperatura del material base sea la adecuada (revisar tabla).

Taladro en posición percusión o martillo.

Taladrar a diámetro y profundidad especificados en la ficha de cada producto.

2 - 6 SOPLAR Y LIMPIAR

Limpiar el agujero de restos de polvo y fragmentos del taladrado según indicaciones del gráfico. Utilizar la bomba de aire y el cepillo. En caso de que el producto no sea admisible para taladros inundados y el taladro contenga agua en su interior, ésta debe ser eliminada antes de inyectar la resina.

A - B* - C ABRIR CARTUCHO

Roscar la cánula en el cartucho y colocar el conjunto en la pistola de aplicación. Apretar el gatillo hasta conseguir que el mortero salga por la punta de un color gris uniforme, sin irisaciones (indica mezcla incorrecta); desechar las dos primeras emboladas de cada cartucho, que no serán utilizadas para fijaciones. * En los cartuchos de 300 ml cortar el extremo de la bolsa, por detrás de la grapa de cierre. ** Valido solo para cartuchos de 300 y 410 ml. Para MOPURE y MOPUR3 consultar ficha técnica.

7 APLICAR MORTERO

Insertar la cánula hasta el fondo del taladro y aplicar mortero; ir retirando la cánula lentamente, asegurándose de que no quedan burbujas de aire.

Rellenar el taladro hasta $\frac{1}{2}$ a $\frac{3}{4}$ de su profundidad.

En caso de que no se use completamente el cartucho dejar la cánula montada. Cambiarla solo en el caso de que se vaya a utilizar de nuevo transcurrido el tiempo de manipulación, volviendo a desechar las dos primeras emboladas.

8 INSTALAR

Introducir el espárrago a instalar con la mano, roscando ligeramente, hasta el fondo del taladro, asegurándose de que el mortero cubre los filetes de rosca. La introducción del anclaje debe realizarse dentro del tiempo de manipulación. Se debe observar rebose del mortero en la boca del taladro para asegurar que el hueco entre el espárrago y el taladro queda relleno completamente.

9 APLICAR PAR DE APRIETE INSTALAR

Una vez transcurrido el tiempo de curado aplicar el par de apriete, no excediendo el valor indicado en la tabla.

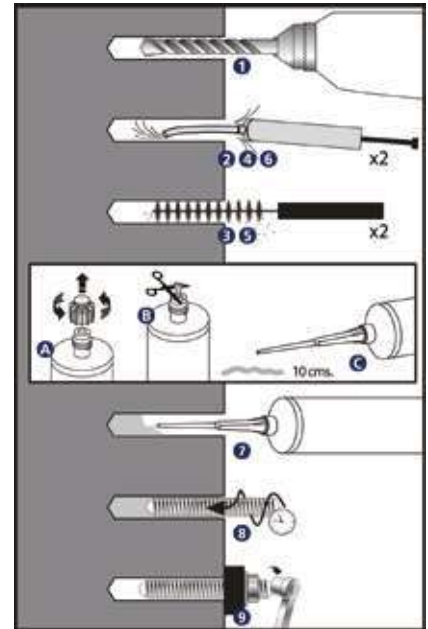

INSTALACIÓN EN LADRILLOS

1 TALADRAR

Comprobar que el ladrillo esté en buen estado y sin poros significativos.

- El producto sea admisible en taladros secos, húmedos o inundados.
- El que la temperatura de los cartuchos sea la adecuada (revisar tabla).
- El que la temperatura del material base sea la adecuada (revisar tabla).

Taladro en posición de rotación.

Taladrar a diámetro y profundidad especificados en la ficha de cada producto

2 - 3 SOPLAR Y LIMPIAR

Limpiar el agujero de restos de polvo y fragmentos del taladrado según indicaciones del gráfico.

Si el taladro tiene agua en su interior ésta debe ser eliminada antes de inyectar la resina.

4 COLOCAR TAMIZ (S)

Insertar el tamiz de plástico o metálico en el taladro de forma que quede rasante con la superficie del material base.

A - B* - C ABRIR CARTUCHO**

Roscar la cánula en el cartucho y colocar el conjunto en la pistola de aplicación. Apretar el gatillo hasta conseguir que el mortero salga por la punta de un color gris uniforme, sin irisaciones (indica mezcla incorrecta); desechar las dos primeras emboladas de cada cartucho, que no serán utilizadas para fijaciones. *En los cartuchos de 170 ml y 300 ml cortar el extremo de la bolsa, por detrás de la grapa de cierre.

** Valido solo para cartuchos de 300 y 410 ml. Para MOPURE y MOPUR3 consultar ficha técnica..

5 APLICAR MORTERO

Insertar la cánula hasta el fondo del tamiz y aplicar mortero; ir retirando la cánula lentamente, asegurándose de que no quedan burbujas de aire. Rellenar el tamiz por completo.

En caso de que no se use completamente el cartucho dejar la cánula montada. Cambiarla solo en el caso de que se vaya a utilizar de nuevo transcurrido el tiempo de manipulación, volviendo a desechar las dos primeras emboladas.

6 INSTALAR

Introducir el espárrago a instalar con la mano, roscando ligeramente, hasta el fondo del taladro, asegurándose de que el mortero cubre los filetes de rosca. La introducción del anclaje debe realizarse dentro del tiempo de manipulación. Se debe observar rebose del mortero en la boca del tamiz para asegurar que el hueco entre el espárrago y el taladro queda relleno completamente.

7 APLICAR PAR DE APRIETE

Una vez transcurrido el tiempo de curado aplicar el par de apriete, no excediendo el valor indicado en la tabla

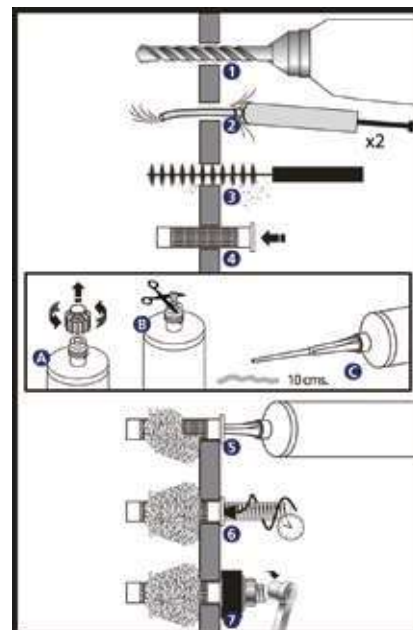

INSTALACIÓN CON TAMIZ PLÁSTICO

MÉTRICA	M8	M10	M12
DIÁMETRO EXTERIOR DEL TAMIZ	15	15	20
LONGITUD DEL AGUJERO	90	90	90
TAMIZ PLÁSTICO	MOTN15085	MOTN15085	MOTN20085

INSTALACIÓN CON TAMIZ ROSCADO

MÉTRICA	M8	M10	M12
DIÁMETRO EXTERIOR DEL TAMIZ	15	20	20
LONGITUD DEL AGUJERO	90	90	90
TAMIZ ROSCADO	MOTRO08	MOTRO10	MOTRO12
TAMIZ PLÁSTICO	MOTN15085	MOTN20085	MOTN20085

TIEMPOS MANIPULACIÓN/CURADO

		0/5	5/10	10/15	15/20	20/25	25,30	30/35	35/40	+40
MO-P	MANIPULACIÓN	18	12	6	6	4	3	2	1,5	1,5
	CURADO	120	120	80	80	40	30	20	15	10
MO-PS	MANIPULACIÓN	18	10	6	6	5	4	4	--	--
	CURADO	145	145	85	85	40	35	35	--	--
MO-PSP	MANIPULACIÓN	18	10	6	6	5	4	4	--	--
	CURADO	145	145	85	85	40	35	35	--	--
MO-V	MANIPULACIÓN	18	12	6	6	4	3	2	1,5	1,5
	CURADO	120	120	80	80	40	30	20	15	10
MO-VS	MANIPULACIÓN	18	10	6	6	5	4	4	--	--
	CURADO	145	145	85	85	50	40	35	--	--
MO-H	MANIPULACIÓN	--	10	8	6	5	4	--	--	--
	CURADO	--	145	85	75	50	40	--	--	--
MO-HW	MANIPULACIÓN	10	5	5	5	100 s	--	--	--	--
	CURADO	75	50	50	50	20	--	--	--	--
MOPU-RE	MANIPULACIÓN	--	20	20	15	11	8	6	4	3
	CURADO	--	1440	720	480	420	360	300	240	180
MO-PUR3	MANIPULACIÓN	300	150	40	25	18	12	8	6	--
	CURADO	1440	1440	1080	720	480	360	240	120	--
MO-PU	MANIPULACIÓN	18	12	6	6	4	3	2	1,5	1,5
	CURADO	120	120	80	80	40	30	20	15	10

Minutos

ANFA

Anclaje para andamios y fachadas

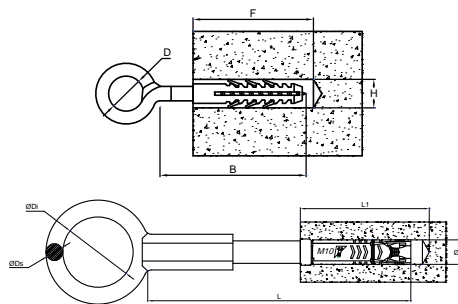

AN-23

Diámetro de ojo 23 mm

CÓDIGO	MXL	Ø BROCA	PROFUNDIDAD MÍN. DE TALADRO	PROFUNDIDAD MÍN. DEL ANCLAJE	MÍN. ESPESOR MATERIAL BASE	Ø OJO	EXTRACCIÓN HORMIGÓN NO-FISURADO
ANFA2309	12 x 90	14 o 16	100	90	130	23	119
ANFA2312	12 x 120	14 o 16	130	120	160	23	119
ANFA2316	12 x 160	14 o 16	170	160	200	23	119
ANFA2319	12 x 190	14 o 16	200	190	230	23	119
ANFA2323	12 x 230	14 o 16	240	230	270	23	119
ANFA2330	12 x 300	14 o 16	310	300	340	23	119
ANFA2335	12 x 350	14 o 16	360	350	390	23	119

AN-51

Diámetro de ojo 51 mm

CÓDIGO	MXL	Ø BROCA	PROFUNDIDAD MÍN. DE TALADRO	PROFUNDIDAD MÍN. DEL ANCLAJE	MÍN. ESPESOR MATERIAL BASE	Ø OJO	EXTRACCIÓN HORMIGÓN NO-FISURADO
ANFA5114	12 x 140	14 o 16	150	140	180	51	119
ANFA5116	12 x 160	14 o 16	170	160	200	51	119
ANFA5120	12 x 200	14 o 16	210	200	240	51	119
ANFA5124	12 x 240	14 o 16	250	240	280	51	119

AN-50 CT

Diámetro de ojo 50 mm + cápsula Zamak M10

CÓDIGO	MXL	PROFUNDIDAD MÍN. DE TALADRO	MÍN. ESPESOR MATERIAL BASE	Ø OJO	EXTRACCIÓN HORMIGÓN NO-FISURADO
ANFAZ5021	M10 x 210	120	160	50	200

CA-QU

Resina de epoxi-acrilato, cuarzo y catalizador. Homologado ETE Opt. 8

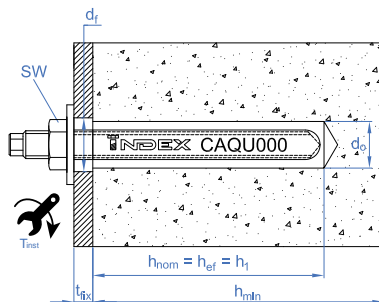

CA-QU

Resina de epoxi-acrilato, cuarzo y catalizador. Homologado ETE Opción 8

CÓDIGO	MXL	ESPEJOR MÁX. A FIJAR	Ø BROCA	PROFUNDIDAD MÍN. DE TALADRO	PROFUNDIDAD MÍN. DEL ANCLAJE	LLAVE DE INSTALACIÓN	PAR DE APRIETE (NM)	Ø ELEMENTO A FIJAR	MÍN. ESPESOR MATERIAL BASE	DISTANCIA MÍN. AL BORDE "A"	DISTANCIA MÍN. ENTRE EJES "B"	EXTRACCIÓN HORMIGÓN NO-FISURADO	CIZALLADURA HORMIGÓN NO-FISURADO
CAQU008	8 Ø9 / 17	17	10	80	80	13	10	9	110	120	240	809	524
CAQU010	10 Ø11 / 25	25	12	90	90	17	20	12	120	90	180	1214	815
CAQU012	12 Ø13 / 32	32	14	110	110	19	40	14	140	110	220	1618	1223
CAQU016	16 Ø17 / 44	44	18	125	125	24	80	18	160	125	250	2023	2272
CAQU020	20 Ø22 / 66	66	25	170	170	30	120	22	220	170	340	3034	3553
CAQU024	24 Ø24 / 62	62	28	210	210	36	180	26	260	210	420	3641	5126
CAQU030	30 Ø33 / 22	22	35	280	280	46	400	33	360	280	560	5461	8496

T-NUX

Taco de nylon universal de alto rendimiento

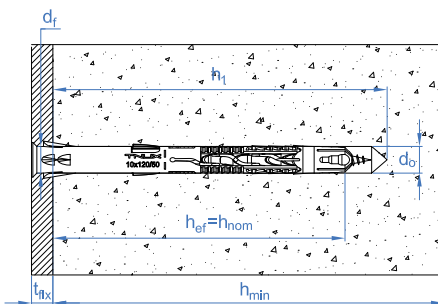

T-NUX A

Cabeza avellanada. Cincado. Homologado ETE

CÓDIGO	MXL	ESPEJOR MÁX. A FIJAR	Ø BROCA	PROFUNDIDAD MÍN. DE TALADRO	PROFUNDIDAD MÍN. DEL ANCLAJE	LLAVE DE INSTALACIÓN	Ø ELEMENTO A FIJAR	MÍN. ESPESOR MATERIAL BASE	DISTANCIA MÍN. AL BORDE "A"	DISTANCIA MÍN. ENTRE EJES "B"	EXTRACCIÓN HORMIGÓN NO-FISURADO	CIZALLADURA HORMIGÓN NO-FISURADO
TNUXA08060	8 x 60	10	8	70	50	TX30	8 - 8,5	100	60	100	141	263
TNUXA08080	8 x 80	10	8	90	70	TX30	8 - 8,5	100	60	100	141	263
TNUXA08100	8 x 100	30	8	90	70	TX30	8 - 8,5	100	60	100	141	263
TNUXA08120	8 x 120	50	8	90	70	TX30	8 - 8,5	100	60	100	141	263
TNUXA10060	10 x 60	10	10	70	50	TX40	10 - 11	100	60	100	202	364
TNUXA10080	10 x 80	10	10	90	70	TX40	10 - 11	100	70	100	202	364
TNUXA10100	10 x 100	30	10	90	70	TX40	10 - 11	100	70	100	202	364
TNUXA10120	10 x 120	50	10	90	70	TX40	10 - 11	100	70	100	202	364
TNUXA10140	10 x 140	70	10	90	70	TX40	10 - 11	100	70	100	202	364
TNUXA10160	10 x 160	90	10	90	70	TX40	10 - 11	100	70	100	202	364
TNUXA10180	10 x 180	110	10	90	70	TX40	10 - 11	100	70	100	202	364
TNUXA10200	10 x 200	130	10	90	70	TX40	10 - 11	100	70	100	202	364
TNUXA10230	10 x 230	160	10	90	70	TX40	10 - 11	100	70	100	202	364

T-NUX A A4

Inoxidable A4. Cabeza avellanada. Homologado ETE

CÓDIGO	MXL	ESPEJOR MÁX. A FIJAR	Ø BROCA	PROFUNDIDAD MIN. DE TALADRO	PROFUNDIDAD MIN. DEL ANCLAJE	LLAVE DE INSTALACIÓN	Ø ELEMENTO A FIJAR	MÍN. ESPEJOR MATERIAL BASE	DISTANCIA MIN. AL BORDE "A"	DISTANCIA MIN. ENTRE EJES "B"	EXTRACCIÓN HORMIGÓN NO-FISURADO	CIZALLADURA HORMIGÓN NO-FISURADO
TNXA408080	8 x 80	10	8	90	70	TX30	8 - 8,5	100	60	100	141	307
TNXA408100	8 x 100	30	8	90	70	TX30	8 - 8,5	100	60	100	141	307
TNXA408120	8 x 120	50	8	90	70	TX30	8 - 8,5	100	60	100	141	307
TNXA410080	10 x 80	10	10	90	70	TX40	10 - 11	100	70	100	202	425
TNXA410100	10 x 100	30	10	90	70	TX40	10 - 11	100	70	100	202	425
TNXA410120	10 x 120	50	10	90	70	TX40	10 - 11	100	70	100	202	425
TNXA410140	10 x 140	70	10	90	70	TX40	10 - 11	100	70	100	202	425

T-NUX E

Cabeza hexagonal. Cincado. Homologado ETE

CÓDIGO	MXL	ESPEJOR MÁX. A FIJAR	Ø BROCA	PROFUNDIDAD MIN. DE TALADRO	PROFUNDIDAD MIN. DEL ANCLAJE	LLAVE DE INSTALACIÓN	Ø ELEMENTO A FIJAR	MÍN. ESPEJOR MATERIAL BASE	DISTANCIA MIN. AL BORDE "A"	DISTANCIA MIN. ENTRE EJES "B"	EXTRACCIÓN HORMIGÓN NO-FISURADO	CIZALLADURA HORMIGÓN NO-FISURADO
TNUXE08060	8 x 60	10	8	70	50	SW10/TX30	8 - 8,5	100	60	100	141	263
TNUXE08080	8 x 80	10	8	90	70	SW10/TX30	8 - 8,5	100	60	100	141	263
TNUXE08100	8 x 100	30	8	90	70	SW10/TX30	8 - 8,5	100	60	100	141	263
TNUXE08120	8 x 120	50	8	90	70	SW10/TX30	8 - 8,5	100	60	100	141	263
TNUXE10060	10 x 60	10	10	70	50	SW13/TX40	10 - 11	100	70	100	202	364
TNUXE10080	10 x 80	10	10	90	70	SW13/TX40	10 - 11	100	70	100	202	364
TNUXE10100	10 x 100	30	10	90	70	SW13/TX40	10 - 11	100	70	100	202	364
TNUXE10120	10 x 120	50	10	90	70	SW13/TX40	10 - 11	100	70	100	202	364
TNUXE10140	10 x 140	70	10	90	70	SW13/TX40	10 - 11	100	70	100	202	364
TNUXE10160	10 x 160	90	10	90	70	SW13/TX40	10 - 11	100	70	100	202	364
TNUXE10180	10 x 180	110	10	90	70	SW13/TX40	10 - 11	100	70	100	202	364
TNUXE10200	10 x 200	130	10	90	70	SW13/TX40	10 - 11	100	70	100	202	364
TNUXE10230	10 x 230	160	10	90	70	SW13/TX40	10 - 11	100	70	100	202	364

T-NUX E A4

Inoxidable A4. Cabeza hexagonal. Homologado ETE

CÓDIGO	MXL	ESPEJOR MÁX. A FIJAR	Ø BROCA	PROFUNDIDAD MIN. DE TALADRO	PROFUNDIDAD MIN. DEL ANCLAJE	LLAVE DE INSTALACIÓN	Ø ELEMENTO A FIJAR	MÍN. ESPEJOR MATERIAL BASE	DISTANCIA MIN. AL BORDE "A"	DISTANCIA MIN. ENTRE EJES "B"	EXTRACCIÓN HORMIGÓN NO-FISURADO	CIZALLADURA HORMIGÓN NO-FISURADO
TNXE408080	8 x 80	10	8	90	70	SW10/TX30	8 - 8,5	100	60	100	141	307
TNXE408100	8 x 100	30	8	90	70	SW10/TX30	8 - 8,5	100	60	100	141	307
TNXE410080	10 x 80	10	10	90	70	SW13/TX40	10 - 11	100	70	100	202	425
TNXE410100	10 x 100	30	10	90	70	SW13/TX40	10 - 11	100	70	100	202	425
TNXE410120	10 x 120	50	10	90	70	SW13/TX40	10 - 11	100	70	100	202	425
TNXE410140	10 x 140	70	10	90	70	SW13/TX40	10 - 11	100	70	100	202	425

T-NUX T

Cabeza Truss inviolable. Cincado. Homologado ETE

CÓDIGO	MXL	ESPEJOR MÁX. A FIJAR	Ø BROCA	PROFUNDIDAD MIN. DE TALADRO	PROFUNDIDAD MIN. DEL ANCLAJE	LLAVE DE INSTALACIÓN	Ø ELEMENTO A FIJAR	MÍN. ESPEJOR MATERIAL BASE	DISTANCIA MIN. AL BORDE "A"	DISTANCIA MIN. ENTRE EJES "B"	EXTRACCIÓN HORMIGÓN NO-FISURADO	CIZALLADURA HORMIGÓN NO-FISURADO
TNUXT10080	10 x 80	10	10	70	50	TX40	10 - 11	100	70	100	202	425
TNUXT10100	10 x 100	30	10	90	70	TX40	10 - 11	100	70	100	202	425
TNUXT10120	10 x 120	50	10	90	70	TX40	10 - 11	100	70	100	202	425
TNUXT10140	10 x 140	70	10	90	70	TX40	10 - 11	100	70	100	202	425
TNUXT10160	10 x 160	90	10	90	70	TX40	10 - 11	100	70	100	202	425

T-FUX E

Taco cabeza cilíndrica. Tornillo cabeza hexagonal. Cincado. Homologado ETE

CÓDIGO	MXL	ESPEJOR MÁX. A FIJAR	Ø BROCA	PROFUNDIDAD MIN. DE TALADRO	PROFUNDIDAD MIN. DEL ANCLAJE	LLAVE DE INSTALACIÓN	Ø ELEMENTO A FIJAR	MÍN. ESPEJOR MATERIAL BASE	DISTANCIA MIN. AL BORDE "A"	DISTANCIA MIN. ENTRE EJES "B"	EXTRACCIÓN HORMIGÓN NO-FISURADO	CIZALLADURA HORMIGÓN NO-FISURADO
TFUXE10080	10 x 80	10	10	90	70	SW13/TX40	10 - 11	100	70	100	202	425
TFUXE10100	10 x 100	30	10	90	70	SW13/TX40	10 - 11	100	70	100	202	425
TFUXE10120	10 x 120	50	10	90	70	SW13/TX40	10 - 11	100	70	100	202	425

TCA

Taco clavable poliamida 6.6

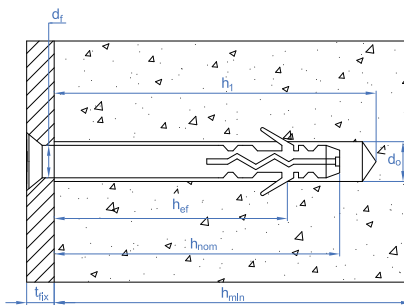

TC-6A

Taco de 6 alas con tornillo avellanado

CÓDIGO	MXL	ESPEJOR MÁX. A FIJAR	Ø BROCA	PROFUNDIDAD MIN. DE TALADRO	Nº HUELLA	EXTRACCIÓN HORMIGÓN NO-FISURADO	CIZALLADURA HORMIGÓN NO-FISURADO	EXTRACCIÓN LADRILLO MACIZO	EXTRACCIÓN LADRILLO HUECO
TC6A08080	8 x 80	15	8	70	TX30	64	37	37	18
TC6A08100	8 x 100	35	8	70	TX30	64	37	37	18

CÓDIGO	MXL	ESPESOR MÁX. A FIJAR	Ø BROCA	PROFUNDIDAD MÍN. DE TALADRO	Nº HUELLA	EXTRACCIÓN HORMIGÓN NO-FISURADO	CIZALLADURA HORMIGÓN NO-FISURADO	EXTRACCIÓN LADRILLO MACIZO	EXTRACCIÓN LADRILLO HUECO
TC6A08120	8 x 120	55	8	70	TX30	64	37	37	18
TC6A10100	10 x 100	25	10	80	TX40	109	55	53	26
TC6A10120	10 x 120	40	10	80	TX40	109	55	53	26
TC6A10140	10 x 140	60	10	80	TX40	109	55	53	26
TC6A10160	10 x 160	85	10	80	TX40	109	55	53	26
TC6A10200	10 x 200	125	10	80	TX40	109	55	53	26

TC-6E

Taco de 6 alas con tornillo hexagonal

CÓDIGO	MXL	ESPESOR MÁX. A FIJAR	Ø BROCA	PROFUNDIDAD MÍN. DE TALADRO	Nº HUELLA	EXTRACCIÓN HORMIGÓN NO-FISURADO	CIZALLADURA HORMIGÓN NO-FISURADO	EXTRACCIÓN LADRILLO MACIZO	EXTRACCIÓN LADRILLO HUECO
TC6E08080	8 x 80	15	8	70	10	64	37	37	18
TC6E08100	8 x 100	35	8	70	10	64	37	37	18
TC6E08120	8 x 120	55	8	70	10	64	37	37	18
TC6E10100	10 x 100	25	10	80	13	109	55	53	26
TC6E10120	10 x 120	40	10	80	13	109	55	53	26
TC6E10140	10 x 140	60	10	80	13	109	55	53	26
TC6E10160	10 x 160	85	10	80	13	109	55	53	26
TC6E10200	10 x 200	125	10	80	13	109	55	53	26

TC-2A

Taco de 2 alas con tornillo avellanado

CÓDIGO	MXL	ESPESOR MÁX. A FIJAR	Ø BROCA	PROFUNDIDAD MÍN. DE TALADRO	Nº HUELLA	EXTRACCIÓN HORMIGÓN NO-FISURADO	CIZALLADURA HORMIGÓN NO-FISURADO	EXTRACCIÓN LADRILLO MACIZO
TC2A06060	6 x 60	30	6	35	2	34	28	10
TC2A08060	8 x 60	20	8	45	3	34	37	19
TC2A08080	8 x 80	40	8	45	3	40	37	19
TC2A08100	8 x 100	60	8	45	3	40	37	19
TC2A08120	8 x 120	80	8	45	3	40	37	19
TC2A10065	10 x 65	20	10	50	4	45	55	22
TC2A10080	10 x 80	35	10	50	4	45	55	22
TC2A10100	10 x 100	55	10	50	4	45	55	22
TC2A10115	10 x 115	70	10	50	4	45	55	22
TC2A10135	10 x 135	90	10	50	4	45	55	22
TC2A10160	10 x 160	115	10	50	4	45	55	22

TC-SP

Taco clavable de alta expansión

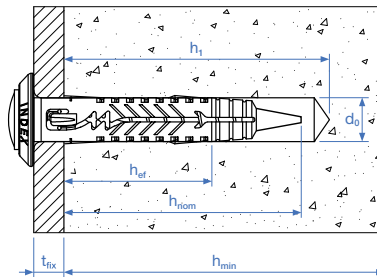

TC-SP

Taco con cabeza avellanada

CÓDIGO	MXL	ESPESOR MÁX. A FIJAR	Ø BROCA	PROFUNDIDAD MÍN. DE TALADRO	Nº HUELLA	EXTRACCIÓN HORMIGÓN NO-FISURADO	EXTRACCIÓN LADRILLO MACIZO
TCSP05027	5 x 27	5	5	25	-	17	5
TCSP06032	6 x 32	5	6	30	-	26	7
TCSP06040	6 x 40	10	6	30	-	26	7

TC

Taco clavable de poliamida 6.6, premontado con tornillo rosca-arpón

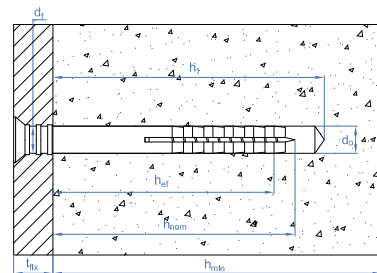

TC-CA

Taco con cabeza avellanada

CÓDIGO	MXL	ESPESOR MÁX. A FIJAR	Ø BROCA	PROFUNDIDAD MÍN. DE TALADRO	Nº HUELLA	EXTRACCIÓN HORMIGÓN NO-FISURADO	CIZALLADURA HORMIGÓN NO-FISURADO	EXTRACCIÓN LADRILLO MACIZO
TCCA05025	5 x 25	5	5	30	PZ2	13	20	3
TCCA05030	5 x 30	5	5	30	PZ2	13	20	3
TCCA05035	5 x 35	10	5	30	PZ2	13	20	3

CÓDIGO	MXL	ESPESOR MÁX. A FIJAR	Ø BROCA	PROFUNDIDAD MÍN. DE TALADRO	Nº HUELLA	EXTRACCIÓN HORMIGÓN NO-FISURADO	CIZALLADURA HORMIGÓN NO-FISURADO	EXTRACCIÓN LADRILLO MACIZO
TCCA05050	5 x 50	25	5	30	PZ2	13	20	3
TCCA06035	6 x 35	10	6	35	PZ2	18	26	4
TCCA06040	6 x 40	10	6	35	PZ2	18	26	4
TCCA06050	6 x 50	20	6	35	PZ2	18	26	4
TCCA06060	6 x 60	30	6	35	PZ2	18	26	4
TCCA06070	6 x 70	40	6	35	PZ2	18	26	4
TCCA06080	6 x 80	50	6	35	PZ2	18	26	4
TCCA08060	8 x 60	20	8	45	PZ3	29	30	7
TCCA08080	8 x 80	40	8	45	PZ3	29	30	7
TCCA08100	8 x 100	60	8	45	PZ3	29	30	7
TCCA08120	8 x 120	80	8	45	PZ3	29	30	7
TCCA08140	8 x 135	100	8	45	PZ3	29	30	7

TC-A2 Taco con cabeza avellanada y tornillo inoxidable A2

CÓDIGO	MXL	ESPESOR MÁX. A FIJAR	Ø BROCA	PROFUNDIDAD MÍN. DE TALADRO	Nº HUELLA	EXTRACCIÓN HORMIGÓN NO-FISURADO	CIZALLADURA HORMIGÓN NO-FISURADO	EXTRACCIÓN LADRILLO MACIZO
TCA205030	5 x 30	5	5	30	PZ2	13	20	3
TCA206040	6 x 40	10	6	35	PZ2	18	26	4
TCA206060	6 x 60	30	6	35	PZ2	18	26	4
TCA208060	8 x 60	20	8	45	PZ3	29	30	7
TCA208080	8 x 80	40	8	45	PZ3	29	30	7
TCA208100	8 x 100	60	8	45	PZ3	29	30	7

TC-CC Taco con cabeza cilíndrica

CÓDIGO	MXL	ESPESOR MÁX. A FIJAR	Ø BROCA	PROFUNDIDAD MÍN. DE TALADRO	Nº HUELLA	EXTRACCIÓN HORMIGÓN NO-FISURADO	CIZALLADURA HORMIGÓN NO-FISURADO	EXTRACCIÓN LADRILLO MACIZO
TCCC05025	5 x 25	5	5	30	PZ2	13	20	3
TCCC05030	5 x 30	5	5	30	PZ2	13	20	3
TCCC05035	5 x 35	10	5	30	PZ2	13	20	3
TCCC05050	5 x 50	25	5	30	PZ2	13	20	3
TCCC06035	6 x 35	10	6	35	PZ2	18	26	4
TCCC06040	6 x 40	15	6	35	PZ2	18	26	4
TCCC06050	6 x 50	25	6	35	PZ2	18	26	4
TCCC06060	6 x 60	35	6	35	PZ2	18	26	4
TCCC06070	6 x 70	45	6	35	PZ2	18	26	4
TCCC06080	6 x 80	55	6	35	PZ2	18	26	4
TCCC08060	8 x 60	20	8	45	PZ3	18	30	7
TCCC08080	8 x 80	40	8	45	PZ3	29	30	7
TCCC08100	8 x 100	60	8	45	PZ3	29	30	7
TCCC08120	8 x 120	80	8	45	PZ3	29	30	7
TCCC08140	8 x 135	100	8	45	PZ3	29	30	7

AIS Taco de fijación de paneles aislantes

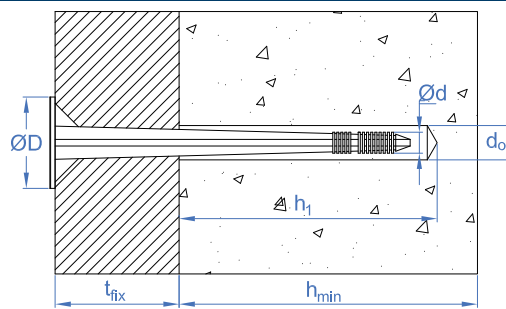

AIS-C Taco con clavo

CÓDIGO	MXL	MÉTRICA	LONGITUD	Ø BROCA	MÍN. ESPESOR MATERIAL BASE	PROFUNDIDAD MÍN. DE TALADRO	PROFUNDIDAD MÍN. DEL ANCLAJE	ESPESOR MÁX. A FIJAR	DISTANCIA MÍN. AL BORDE "A"	DISTANCIA MÍN. ENTRE EJES "B"	ØD(MM)	EXTRACCIÓN HORMIGÓN NO-FISURADO	EXTRACCIÓN LADRILLO HUECO	EXTRACCIÓN LADRILLO MACIZO	EXTRACCIÓN HORMIGÓN FISURADO
AISC10070	10 x 70	10	70	10	100	60	50	20	100	100	60	29	4	36	29
AISC10090	10 x 90	10	90	10	100	60	50	40	100	100	60	29	4	36	29
AISC10100	10 x 100	10	100	10	100	60	50	50	100	100	60	29	4	36	29
AISC10120	10 x 120	10	120	10	100	60	50	70	100	100	60	29	4	36	29
AISC10140	10 x 140	10	140	10	100	60	50	90	100	100	60	29	4	36	29
AISC10160	10 x 160	10	160	10	100	60	50	110	100	100	60	29	4	36	29
AISC10180	10 x 180	10	180	10	100	60	50	130	100	100	60	29	4	36	29
AISC10200	10 x 200	10	200	10	100	60	50	150	100	100	60	29	4	36	29
AISC10220	10 x 220	10	220	10	100	60	50	170	100	100	60	29	4	36	29
AISC10260	10 x 260	10	260	10	100	60	50	210	100	100	60	29	4	36	29

AIS-S

Clavo metálico con tapón plástico

CÓDIGO	MXL	MÉTRICA	LONGITUD	Ø BROCA	MÍN. ESPESOR MATERIAL BASE	PROFUNDIDAD MÍN. DE TALADRO	PROFUNDIDAD MÍN. DEL ANCLAJE	ESPEOR MÁX. A FIJAR	DISTANCIA MIN. AL BORDE "A"	DISTANCIA MIN. ENTRE EJES "B"	Ø(DMM)	EXTRACCIÓN HORMIGÓN NO-FISURADO	EXTRACCIÓN LADRILLO HUECO	EXTRACCIÓN LADRILLO MACIZO	EXTRACCIÓN HORMIGÓN FISURADO
AISS10070	10 x 70	10	70	10	100	60	50	20	100	100	60	20	4	23	20
AISS10090	10 x 90	10	90	10	100	60	50	40	100	100	60	20	4	23	20
AISS10100	10 x 100	10	100	10	100	60	50	50	100	100	60	20	4	23	20
AISS10120	10 x 120	10	120	10	100	60	50	70	100	100	60	20	4	23	20
AISS10140	10 x 140	10	140	10	100	60	50	90	100	100	60	20	4	23	20
AISS10160	10 x 160	10	160	10	100	60	50	110	100	100	60	20	4	23	20
AISS10180	10 x 180	10	180	10	100	60	50	130	100	100	60	20	4	23	20
AISS10200	10 x 200	10	200	10	100	60	50	150	100	100	60	20	4	23	20
AISS10220	10 x 220	10	220	10	100	60	50	170	100	100	60	20	4	23	20
AISS10260	10 x 260	10	260	10	100	60	50	210	100	100	60	20	4	23	20

AIS

Taco

CÓDIGO	MXL	ESPEOR MÁX. A FIJAR	Ø BROCA	PROFUNDIDAD MÍN. DE TALADRO	PROFUNDIDAD MÍN. DEL ANCLAJE	Ø ARANDELA	EXTRACCIÓN HORMIGÓN NO-FISURADO
AIS08080	8 x 80	50	8	30	30	35	1
AIS08100	8 x 100	70	8	30	30	35	1
AIS08120	8 x 120	90	8	30	30	35	1
AIS08140	8 x 140	110	8	30	30	35	1

AIS-R

Rosetón

CÓDIGO	MXL	Ø(DMM)	D
AISR140	Ø140	140	11

AIS-W

Rosetón para uso con tornillo

CÓDIGO	MXL	Ø(DMM)	D
AISW060	Ø60	60	6

AIS-M

Taco metálico

CÓDIGO	MXL	MÉTRICA	LONGITUD	Ø BROCA	MÍN. ESPESOR MATERIAL BASE	PROFUNDIDAD MÍN. DE TALADRO	PROFUNDIDAD MÍN. DEL ANCLAJE	ESPEOR MÁX. A FIJAR	DISTANCIA MIN. AL BORDE "A"	DISTANCIA MIN. ENTRE EJES "B"	Ø(DMM)
AISM08090	8 x 90	8	90	8	100	50	40	50	100	100	35
AISM08110	8 x 110	8	110	8	100	50	40	70	100	100	35
AISM08120	8 x 120	8	120	8	100	50	40	80	100	100	35
AISM08140	8 x 140	8	140	8	100	50	40	100	100	100	35
AISM08170	8 x 170	8	170	8	100	50	40	130	100	100	35
AISM08200	8 x 200	8	200	8	100	50	40	160	100	100	35
AISM08250	8 x 250	8	250	8	100	50	40	210	100	100	35
AISM08300	8 x 300	8	300	8	100	50	40	260	100	100	35

AIS-AM

Arandela para taco metálico

CÓDIGO	MXL	Ø(DMM)	L1	D
AISAM085	Ø85	85	0,5	9

TE

Anclaje espiral

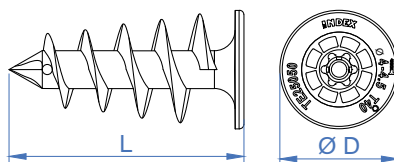

TE

CÓDIGO	MXL	LONGITUD	Ø(DMM)
TE25050	25 x 50	50	25
TE25090	25 x 90	90	25

TN4S

Taco de nylon anudable de 4 segmentos para todo tipo de materiales

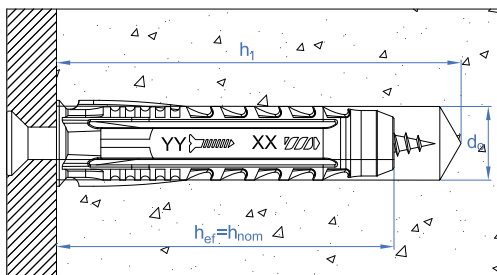

TN4S

Taco

CÓDIGO	MXL	Ø BROCA	PROFUNDIDAD MÍN. DE TALADRO	PROFUNDIDAD MÍN. DEL ANCLAJE	MÍN. ESPESOR MATERIAL BASE	EXTRACCIÓN HORMIGÓN NO-FISURADO	EXTRACCIÓN LADRILLO MACIZO	EXTRACCIÓN LADRILLO HUECO	MEDIDA TORNILLO
TN4S05	5 x 25	5	30	25	35	28	19	13	TPPO 2,5-4
TN4S06	6 x 30	6	40	30	45	61	48	39	TPPO 3,5-4
TN4S08	8 x 40	8	50	40	55	170	104	20	TPPO 4,5, TB 5-6
TN4S10	10 x 50	10	60	50	65	256	160	48	TB 6-8
TN4S12	12 x 60	12	70	60	75	394	104	54	TB 8-10
TN4S14	14 x 70	14	80	70	85	628	224	75	TB 10-12

TN4S-L

Taco largo

CÓDIGO	MXL	Ø BROCA	PROFUNDIDAD MÍN. DE TALADRO	PROFUNDIDAD MÍN. DEL ANCLAJE	MÍN. ESPESOR MATERIAL BASE	EXTRACCIÓN HORMIGÓN NO-FISURADO	EXTRACCIÓN LADRILLO MACIZO	EXTRACCIÓN LADRILLO HUECO	MEDIDA TORNILLO
TN4S06L	6 x 45	6	55	45	60	60	35	39	TPPO 3,5-4
TN4S08L	8 x 60	8	70	60	75	129	68	43	TPPO 4,5, TB 5-6
TN4S10L	10 x 80	10	90	80	95	0	210	46	TB 6-8

MEDU

Taco universal con collarín y forma de nudo

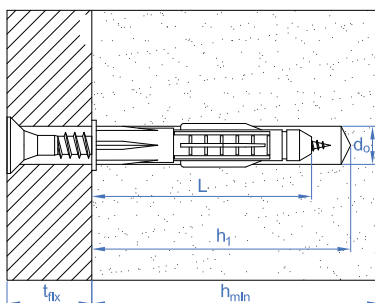

MEDU

Polipropileno

CÓDIGO	MXL	Ø BROCA	PROFUNDIDAD MÍN. DE TALADRO	MÍN. ESPESOR MATERIAL BASE	EXTRACCIÓN HORMIGÓN NO-FISURADO	EXTRACCIÓN LADRILLO MACIZO	EXTRACCIÓN LADRILLO HUECO
MEDUB06	6 x 35	6	45	65	8	5	4
MEDUB07	8 x 42	8	50	70	12	5	4
MEDUB08	8 x 50	8	60	80	24	5	4
MEDUB10	10 x 60	10	75	95	70	7	5

TACON

Taco de nylon

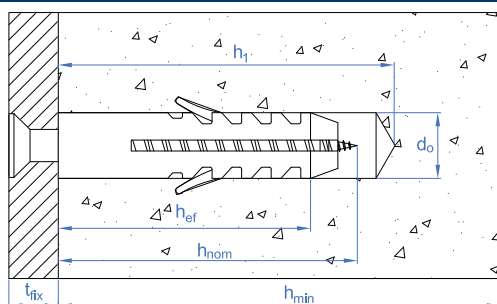

TACON/TACOL/TACOL-A

Taco

CÓDIGO	MXL	Ø BROCA	PROFUNDIDAD MÍN. DE TALADRO	PROFUNDIDAD MÍN. DEL ANCLAJE	MÍN. ESPESOR MATERIAL BASE	EXTRACCIÓN HORMIGÓN NO-FISURADO	EXTRACCIÓN LADRILLO MACIZO	MEDIDA TORNILLO
TACON04	4 x 20	4	25	20	30	6	4	TPPO 2,5-3
TACON05/TACOL05/	5 x 25	5	35	25	40	7	5	TPPO 2,5-4

CÓDIGO	MXL	Ø BROCA	PROFUNDIDAD MÍN. DE TALADRO	PROFUNDIDAD MÍN. DEL ANCLAJE	MÍN. ESPESOR MATERIAL BASE	EXTRACCIÓN HORMIGÓN NO-FISURADO	EXTRACCIÓN LADRILLO MACIZO	MEDIDA TORNILLO
TACON06/TACOL06/TACOLA06	6 x 30	6	40	30	45	10	5	TPPO 3,5-4
TACON07	7 x 30	7	45	30	45	11	6	TPPO 4-4,5
TACON08/TACOL08	8 x 40	8	50	40	55	12	11	TPPO 4,5, TB 5-6
TACON10/TACOL10	10 x 50	10	60	50	70	61	16	TB 6-8
TACON12/TACOL12	12 x 60	12	70	60	80	76	28	TB 8-10
TACON14	14 x 70	14	80	70	95	167	88	TB 10-12
TACON16	16 x 80	16	90	80	100	240	100	TB 12-14

IPA

Taco de nylon para ladrillos huecos y materiales macizos

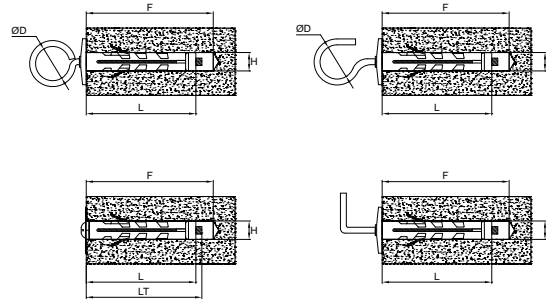

IPA-GR

Gancho recto

CÓDIGO	MXL	ESPEJOR MÁX. A FIJAR	Ø BROCA	PROFUNDIDAD MÍN. DE TALADRO	PROFUNDIDAD MÍN. DEL ANCLAJE	Ø ARANDELA	EXTRACCIÓN HORMIGÓN NO-FISURADO	EXTRACCIÓN LADRILLO MACIZO
IPAGR09	M4 x 40	-	9	45	40	20	8	8
IPAGR12	M5 x 45	-	12	50	45	25	12	12

IPA-GN

Gancho normal

CÓDIGO	MXL	ESPEJOR MÁX. A FIJAR	Ø BROCA	PROFUNDIDAD MÍN. DE TALADRO	PROFUNDIDAD MÍN. DEL ANCLAJE	Ø ARANDELA	EXTRACCIÓN HORMIGÓN NO-FISURADO	EXTRACCIÓN LADRILLO MACIZO
IPAGN09	M4 x 40	-	9	45	40	20	8	8
IPAGN12	M5 x 45	-	12	50	45	25	10	10

IPA-AR

Argolla

CÓDIGO	MXL	ESPEJOR MÁX. A FIJAR	Ø BROCA	PROFUNDIDAD MÍN. DE TALADRO	PROFUNDIDAD MÍN. DEL ANCLAJE	Ø ARANDELA	EXTRACCIÓN HORMIGÓN NO-FISURADO	EXTRACCIÓN LADRILLO MACIZO
IPAAR09	M4 x 40	-	9	45	40	20	8	8
IPAAR12	M5 x 45	-	12	50	45	25	10	10

IPA-TO

Tornillo

CÓDIGO	MXL	ESPEJOR MÁX. A FIJAR	Ø BROCA	PROFUNDIDAD MÍN. DE TALADRO	PROFUNDIDAD MÍN. DEL ANCLAJE	Ø ARANDELA	EXTRACCIÓN HORMIGÓN NO-FISURADO	EXTRACCIÓN LADRILLO MACIZO
IPATO09	M4 x 40	5	9	45	40	20	8	44
IPATO12	M5 x 45	5	12	50	45	25	12	56

TA-PL

Taco de plástico (polipropileno)

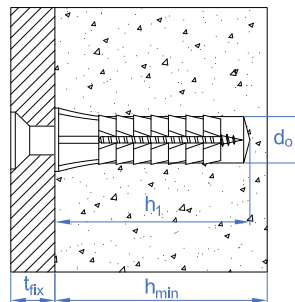

TA-PL

Taco de plástico, polipropileno

CÓDIGO	MXL	Ø BROCA	PROFUNDIDAD MÍN. DE TALADRO	MÍN. ESPESOR MATERIAL BASE	EXTRACCIÓN HORMIGÓN NO-FISURADO
TACOP05	5 x 21	5	30	35	5
TACOP06	6 x 22	6	30	35	5
TACOP07	7 x 23	7	30	35	6
TACOP08	8 x 27	8	35	40	9
TACOP09	9 x 30	9	35	40	9
TACOP10	10 x 35	10	40	45	13
TACOP11	10 x 43	10	50	55	15
TACOP12	12 x 45	12	50	55	17
TACOP14	14 x 48	14	55	60	28

BA-NO

Basculantes por gravedad para la fijación de elementos ligeros en falsos techos

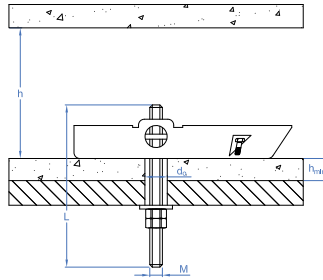

BA-ES

Espiga

CÓDIGO	MXL	MAX. ESPESOR CONJUNTO MATERIAL BASE Y ELEMENTO A FIJAR s	Ø BROCA	CAVIDAD MINIMA "H"	EXTRACCIÓN BOVEDILLA DE HORMIGÓN	EXTRACCIÓN CARTÓN YESO	EXTRACCIÓN ESCAYOLA
BAESM04	M4 x 100	74	14	70	10	5	5
BAESM05	M5 x 100	72	14	70	12	5	5
BAESM06	M6 x 100	68	16	75	13	6	6
BAESM08	M8 x 100	60	20	85	14	6	6

BA-GA

Gancho

CÓDIGO	MXL	MAX. ESPESOR CONJUNTO MATERIAL BASE Y ELEMENTO A FIJAR s	Ø BROCA	CAVIDAD MINIMA "H"	EXTRACCIÓN BOVEDILLA DE HORMIGÓN	EXTRACCIÓN CARTÓN YESO	EXTRACCIÓN ESCAYOLA
BAGAM04	M4 x 77	74	14	70	10	5	5
BAGAM05	M5 x 80	72	14	70	12	5	5
BAGAM06	M6 x 87	68	16	75	13	6	6
BAGAM08	M8 x 95	60	20	85	14	6	6

PA-LO

Palomilla con muelle

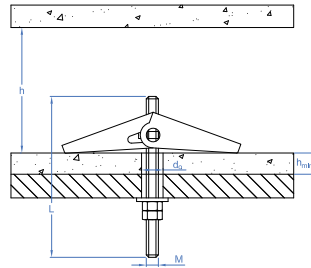

PA-ES

Espiga

CÓDIGO	MXL	MAX. ESPESOR CONJUNTO MATERIAL BASE Y ELEMENTO A FIJAR s	Ø BROCA	CAVIDAD MINIMA "H"	EXTRACCIÓN BOVEDILLA DE HORMIGÓN	EXTRACCIÓN CARTÓN YESO	EXTRACCIÓN ESCAYOLA
PAESM04	M4 x 100	75	12	26	10	5	5
PAESM05	M5 x 100	70	15	33	12	5	5
PAESM06	M6 x 100	66	18	37	13	6	6
PAESM08	M8 x 100	61	22	54	14	6	6

PA-GA

Gancho

CÓDIGO	MXL	MAX. ESPESOR CONJUNTO MATERIAL BASE Y ELEMENTO A FIJAR s	Ø BROCA	CAVIDAD MINIMA "H"	EXTRACCIÓN BOVEDILLA DE HORMIGÓN	EXTRACCIÓN CARTÓN YESO	EXTRACCIÓN ESCAYOLA
PAGAM04	M4 x 55	75	12	26	10	5	5
PAGAM05	M5 x 65	70	15	33	12	5	5
PAGAM06	M6 x 80	66	18	37	13	6	6
PAGAM08	M8 x 85	61	22	54	14	6	6

IN

Anclaje Indemoll para fijación en elementos huecos

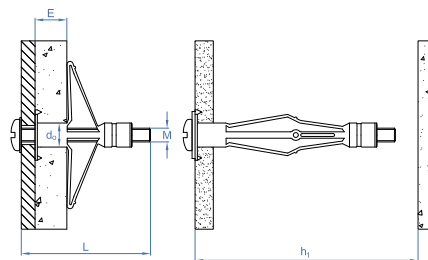

IN-CO

Con tornillo cabeza redonda

CÓDIGO	MXL	Ø BROCA	CAVIDAD MINIMA "H"	MÍN. ESPESOR MATERIAL BASE	ESPESOR MÁX. A FIJAR	EXTRACCIÓN CARTÓN YESO	EXTRACCIÓN ESCAYOLA
INCO421	M4 x 30	8	30	1-5	17 -hmin	20	20
INCO432	M4 x 41	8	41	3-10	22 -hmin	20	20

CÓDIGO	MXL	Ø BROCA	CAVIDAD MINIMA "H"	MÍN. ESPESOR MATERIAL BASE	ESPEOR MÁX. A FIJAR	EXTRACCIÓN CARTÓN YESO	EXTRACCIÓN ESCAYOLA
INCO438	M4 x 47	8	47	9-16	30 -hmin	20	20
INCO446	M4 x 53	8	53	15-22	33 -hmin	20	20
INCO459	M4 x 67	8	67	31-36	52 -hmin	20	20
INCO537	M5 x 46	10	46	5-14	26 -hmin	20	25
INCO552	M5 x 59	10	59	6-18	42 -hmin	20	30
INCO565	M5 x 72	10	72	16-33	55 -hmin	20	30
INCO580	M5 x 89	10	89	33-46	61 -hmin	20	30
INCO637	M6 x 46	12	46	5-13	25 -hmin	15	20
INCO652	M6 x 59	12	59	6-17	38 -hmin	20	25
INCO665	M6 x 72	12	72	14-32	49 -hmin	20	25
INCO680	M6 x 89	12	89	34-46	78 -hmin	20	25

IN-HE

Con tornillo cabeza hexagonal

CÓDIGO	MXL	Ø BROCA	CAVIDAD MINIMA "H"	MÍN. ESPESOR MATERIAL BASE	ESPEOR MÁX. A FIJAR	EXTRACCIÓN CARTÓN YESO	EXTRACCIÓN ESCAYOLA
INHE837	M8 x 45	14	45	5-13	25 -hmin	20	40
INHE855	M8 x 60	14	60	6-18	36 -hmin	20	40
INHE865	M8 x 73	14	73	17-33	47 -hmin	20	40

ANCLA

Taco de nylon para ladrillos huecos y placas de yeso

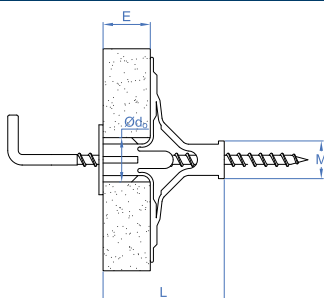

ANCLA

Taco de nylon para ladrillos huecos y placas de cartón yeso

CÓDIGO	MXL	Ø BROCA	MÍN. ESPESOR MATERIAL BASE	EXTRACCIÓN LADRILLO HUECO	EXTRACCIÓN CARTÓN YESO
ANCLA40	10 x 40	10	4-12	10	5
ANCLA47	10 x 47	10	15-19	10	5

TAPLA

Taco para placas de yeso laminado

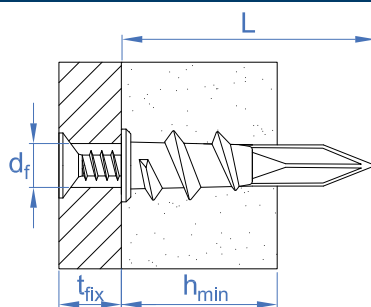

TAPLA NY

Taco de nylon

CÓDIGO	MXL	MÍN. ESPESOR MATERIAL BASE	VÁLIDO PARA	Nº HUELLA	EXTRACCIÓN CARTÓN YESO
TAPLANY	15 x 33	9-16	TPPO 4,5 x 40 / DIN-7981 4,2 x 38	PH3	8

TAPLA ME

Taco de Zamak con tornillo DIN 7981 4,2 x 32

CÓDIGO	MXL	MÍN. ESPESOR MATERIAL BASE	VÁLIDO PARA	Nº HUELLA	EXTRACCIÓN CARTÓN YESO
TAPLAME	13 x 32	9-16	DIN-7981 4,2 x 32	PH2/PH3	8

TAPLA ZK

Taco de Zamak

CÓDIGO	MXL	MÍN. ESPESOR MATERIAL BASE	VÁLIDO PARA	Nº HUELLA	EXTRACCIÓN CARTÓN YESO
TAPLAZK	13 x 37	9-16	TPPO 4,5 x 50 / DIN-7981 4,2 x 38	PZ3	8

AL

Alcayatas

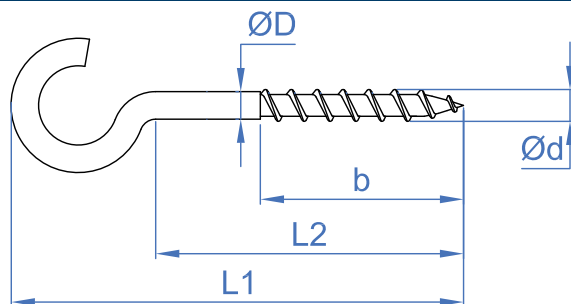

AL-HA

Hembrilla abierta

CODIGO	MXL	Ød	L1	B	L2	ØD
ALHA14025	2,6 x 18 x 7	2,6	18	7	10	2,1
ALHA16030	3,1 x 22 x 9	3,1	22	9	12	2,4
ALHA17040	3,5 x 26 x 10	3,5	26	10	14	2,7
ALHA18040	4,1 x 29 x 10	4,1	29	10	15	3,2
ALHA18050	4,1 x 34 x 12	4,1	34	12	20	3,2
ALHA19050	4,4 x 33 x 12	4,4	33	12	18	3,4
ALHA19060	4,4 x 39 x 15	4,4	39	15	22	3,4
ALHA19070	4,4 x 41 x 15	4,4	41	15	24	3,4
ALHA20050	5 x 35 x 12	5	35	12	19	3,9
ALHA20060	5 x 39 x 12	5	39	12	21	3,9
ALHA20070	5 x 44 x 14	5	44	14	26	3,9
ALHA20080	5 x 50 x 18	5	50	18	30	3,9
ALHA21070	5,6 x 43 x 14	5,6	43	14	23	4,4
ALHA21080	5,6 x 48 x 14	5,6	48	14	28	4,4
ALHA21090	5,6 x 56 x 14	5,6	56	14	32	4,4
ALHA21100	5,6 x 61 x 18	5,6	61	18	37	4,4
ALHA22110	6 x 69 x 24	6	69	24	43	4,7
ALHA22120	6 x 74 x 29	6	74	29	48	4,7
ALHA23130	6,3 x 82 x 35	6,3	82	35	55	5,2

AL-HA B

Hembrilla abierta roscada lacada blanca

CÓDIGO	MXL	Ød	L1	B	L2	ØD
ALHAB16030	3,1 x 22 x 9	3,1	22	9	12	2,4
ALHAB17040	3,5 x 26 x 10	3,5	26	10	14	2,7
ALHAB18050	4,1 x 34 x 12	4,1	34	12	20	3,2
ALHAB19060	4,4 x 39 x 15	4,4	39	15	22	3,4

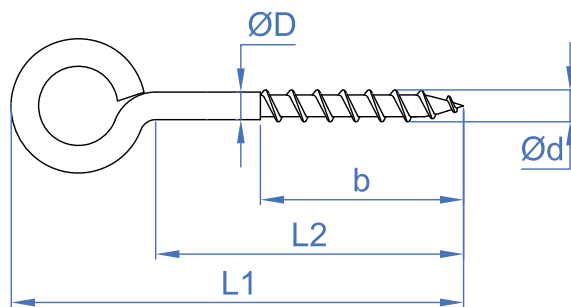

AL-HC

Hembrilla cerrada

CODIGO	MXL	Ød	L1	B	L2	ØD
ALHC14025	2,6 x 18 x 7	2,6	18	7	10	2,1
ALHC16030	3,1 x 22 x 9	3,1	22	9	12	2,4
ALHC17040	3,5 x 28 x 10	3,5	28	10	14	2,7
ALHC18040	4,1 x 30 x 10	4,1	30	10	15	3,2
ALHC18050	3,7 x 39 x 12	4,1	39	12	20	3,2
ALHC19050	4,4 x 35 x 12	4,4	35	12	18	3,4
ALHC19060	4,4 x 42 x 15	4,4	42	15	22	3,4
ALHC19070	4,4 x 44 x 15	4,4	44	15	24	3,4

CODIGO	MXL	Ød	L1	B	L2	ØD
ALHC20050	5 x 39 x 12	5	35	12	19	3,9
ALHC20060	5 x 41 x 12	5	39	12	21	3,9
ALHC20070	5 x 48 x 14	5	43,8	14	26	3,9
ALHC20080	5 x 54 x 18	5	50	18	30	3,9
ALHC21070	5,6 x 49 x 14	5,6	43	14	23	4,4
ALHC21080	5,6 x 54 x 14	5,6	48	14	28	4,4
ALHC21090	5,6 x 61 x 14	5,6	56	14	32	4,4
ALHC21100	5,6 x 66 x 18	5,6	62	18	37	4,4
ALHC22110	6 x 73 x 24	6	69	24	43	4,7
ALHC22120	6 x 81 x 29	6	75	29	48	4,7
ALHC23130	6,3 x 89 x 35	6,3	83	35	55	5,2

AL-HC B

Hembrilla cerrada roscada lacada blanca

CÓDIGO	MXL	Ød	L1	B	L2	ØD
ALHCB16030	3,1 x 22 x 9	3,1	22	9	12	2,4
ALHCB17040	3,5 x 28 x 10	3,5	28	10	14	2,7
ALHCB18050	3,7 x 39 x 12	3,7	39	12	20	3,2
ALHCB19060	4,4 x 42 x 15	4,4	42	15	22	3,4

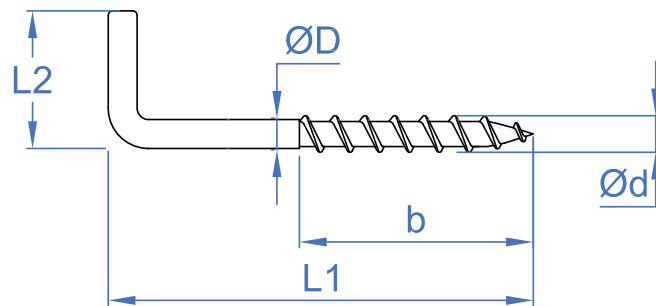

AL-RO

Alcayata roscada de hierro

CODIGO	MXL	Ød	L1	L2	B	ØD
ALRO14025	2,6 x 17 x 10	2,6	17	10	10	2
ALRO16030	3,1 x 20 x 10	3,1	20	10	12	2,4
ALRO17040	3,5 x 29 x 13	3,5	29	13	17	2,7
ALRO18040	3,7 x 28 x 14	3,7	28	14	17	2,9
ALRO18050	3,7 x 37 x 15	3,7	37	15	22	2,9
ALRO19050	4,4 x 37 x 15	4,4	37	15	22	3,4
ALRO19060	4,4 x 46 x 17	4,4	46	17	28	3,4
ALRO19070	4,4 x 55 x 18	4,4	55	18	33	3,4
ALRO20060	5 x 44 x 20	5	44	20	26	3,9
ALRO20070	5 x 53 x 20	5	53	20	32	3,9
ALRO20080	5 x 63 x 21	5	63	21	38	3,9
ALRO21080	5,6 x 60 x 22	5,6	60	22	36	4,4
ALRO21090	5,6 x 70 x 22	5,6	70	22	42	4,4
ALRO22100	6 x 79 x 23	6	79	23	47	4,7
ALRO22110	6 x 86 x 23	6	86	23	52	4,7
ALRO22120	6 x 97 x 25	6	97	25	58	4,7
ALRO23130	7,8 x 105 x 25	7,8	105	25	63	5,8

AL-RO B

Alcayata roscada lacada blanca

CÓDIGO	MXL	Ød	L1	L2	B	ØD
ALROB16030	3,1 x 20 x 10	3,1	20	10	10	2,4
ALROB17040	3,5 x 29 x 13	3,5	29	13	13	2,7
ALROB18050	3,7 x 37 x 15	3,7	37	15	18	2,9
ALROB19060	4,4 x 46 x 17	4,4	46	17	24	3,4

Parámetros punta-broca

			Ø 3.5	Ø 3.9	Ø 4.2	Ø 4.8	Ø 5.5	Ø 6.3
Fuerza máxima instalación	N		150	200	250	250	350	350
Velocidad taladrado	Acero	rpm	1.800 - 2500				1000 - 1800	
	Acero inox	rpm	1.000 - 1500				600 - 1000	
Par máximo	Nm		2.8	3.8	4.7	6.9	10.4	16.9



Taladro previo rosca-chapa

Medida	Espesor de chapa	Ø Broca núcleo		Medida	Espesor de chapa	Ø Broca núcleo	
		Aluminio	Acero-latón			Aluminio	Acero-latón
2,9 Nº4	0,4 - 0,6	2,20	2,25	4,8 Nº10	0,4 - 0,6	-	-
	0,6 - 1,0	2,20	2,40		0,6 - 1,0	3,70	3,80
	1,0 - 1,5	2,25	2,40		1,0 - 1,5	3,70	3,80
	1,5 - 2,5	2,40	2,50		1,5 - 2,5	3,80	3,90
	2,5 - 4,0	-	-		2,5 - 4,0	3,80	4,00
3,5 Nº6	0,4 - 0,6	2,70	2,70	5,5 Nº12	0,4 - 0,6	-	-
	0,6 - 1,0	2,70	2,80		0,6 - 1,0	4,30	4,40
	1,0 - 1,5	2,80	2,80		1,0 - 1,5	4,30	4,40
	1,5 - 2,5	2,80	2,90		1,5 - 2,5	4,40	4,50
	2,5 - 4,0	-	3,00		2,5 - 4,0	4,40	4,60
3,9 Nº7	0,4 - 0,6	-	-	6,3 Nº14	0,4 - 0,6	-	-
	0,6 - 1,0	3,00	3,10		0,6 - 1,0	5,00	5,10
	1,0 - 1,5	3,00	3,10		1,0 - 1,5	5,00	5,10
	1,5 - 2,5	3,10	3,20		1,5 - 2,5	5,10	5,20
	2,5 - 4,0	3,10	3,30		2,5 - 4,0	5,10	5,30
4,2 Nº8	0,4 - 0,6	-	-				
	0,6 - 1,0	3,20	3,30				
	1,0 - 1,5	3,20	3,30				
	1,5 - 2,5	3,30	3,40				
	2,5 - 4,0	3,30	3,50				



Tabla de selección de tornillos punta broca

TORNILLO	Ø ROSCA	ESPESOR A TALADRAR EN ACERO [mm]																		
AUTO	5,5	4,0																	12,0	
ABE ABR ABP RS	6,3	2,5													6,0					
	5,5	1,75										5,25								
	4,8	1,75										4,4								
	4,2	1,75										3,0								
	3,9	0,7		2,4																
	3,5	0,7		2,25																
ABA / ATA	6,3	2,5													6,0					
	5,5	1,75										5,0								
	4,8	1,75										4,0								
TAE	4,2	0,75		2,5																
BCP	4,2	0,7		2,0																
ARE	6,3	1,0		1,5																
	5,5	1,0		1,5																
	4,8	0,3		1,0																
PS	5,5	1,5										6,0								
PSL	5,5	6,0																	12,0	

0,00 0,25 0,50 0,75 1,00 1,25 1,50 1,75 2,00 2,25 2,50 2,75 3,00 3,25 3,50 3,75 4,00 4,25 4,50 4,75 5,00 5,25 5,50 5,75 6,00 6,5 7,0 7,5 8,0 8,5 9,0 9,5 10,0 10,5 11,0 11,5 12,0

TORNILLO	Ø ROSCA	ESPESOR A TALADRAR EN ALUMINIO [mm]																		
BIE	4,8	1,75										4,4								
	5,5	1,75										5,25								
	6,3	2,5										6,0								
BAUTO	5,5	4,0																	12,0	

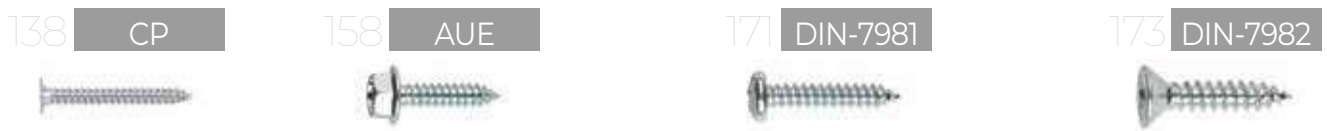
0,00 0,25 0,50 0,75 1,00 1,25 1,50 1,75 2,00 2,25 2,50 2,75 3,00 3,25 3,50 3,75 4,00 4,25 4,50 4,75 5,00 5,25 5,50 5,75 6,00 6,5 7,0 7,5 8,0 8,5 9,0 9,5 10,0 10,5 11,0 11,5 12,0

Espeor máximo a fijar

LONGITUD	ST 3,5	ST 3,9	ST 4,2	ST 4,8	ST 5,5	ST 6,3
9,5	2,85					
11	4,2					
13	6,2	5,8	4,3	3,7		
16	9,2	8,8	7,3	5,5		
19	12,1	11,7	10,3	8,7	8,7	7
22	15,1	14,7	13,3	11,7	11,7	10
25	18,1	17,7	16,3	14,7	14,7	13
32	25,1	24,5	23	21,5	21,5	20
38		30,5	29	27,5	27,5	26
45			36	34,5	34,5	33
50			41	39,5	39,5	38
60				49,5	49,5	48
63				52,5	52,5	51
73				62,5	62,5	61
75				64,5	64,5	63
80				69,5		68
90				79,5		78
100				89,5		88
110						98
120						108
130						118
140						128

* No válido para tornillo AUTO

AB-IA / AB-RA Abrazadera reforzada M8 abierta

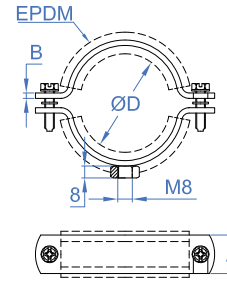
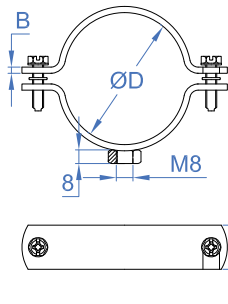

AB-RA / AB-IA Abrazadera reforzada M8 Abierta

CÓDIGO	ØD(MM)	ØD(°)	A X B	CARGA MÁXIMA
ABIA015 / ABRA015	12 - 16	1/4"	20 x 1,5	80
ABIA018 / ABRA018	15 - 19	3/8"	20 x 1,5	80
ABIA022 / ABRA022	20 - 25	1/2"	20 x 1,5	80
ABIA028 / ABRA028	26 - 30	3/4"	20 x 1,5	80
ABIA035 / ABRA035	32 - 36	1"	20 x 1,5	80
ABIA042 / ABRA042	38 - 43	1 1/4"	20 x 1,5	80
ABIA048 / ABRA048	47 - 51	1 1/2"	20 x 1,5	80
ABIA054 / ABRA054	53 - 58	-	20 x 1,5	80
ABIA060 / ABRA060	60 - 64	2"	20 x 1,5	80
ABIA075 / ABRA075	75 - 80	2 1/2"	20 x 1,5	80
ABIA090 / ABRA090	87 - 92	3"	20 x 1,5	80
ABIA100 / ABRA100	99 - 105	3 1/2"	20 x 1,5	80
ABIA110 / ABRA110	107 - 112	-	20 x 1,5	80
ABIA115 / ABRA115	113 - 118	4"	20 x 1,5	80
ABIA125 / ABRA125	125 - 130	4 1/2"	20 x 1,5	80

AB-IR Abrazadera isofónica M8 instalación rápida

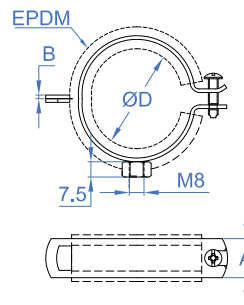

AB-IR Abrazadera isofónica M8 instalación rápida

CÓDIGO	ØD(MM)	ØD(°)	A X B	CARGA MÁXIMA
ABIR015	14 - 15	1/4"	19 x 1,25	60
ABIR018	16 - 19	3/8"	19 x 1,25	60
ABIR022	21 - 23	1/2"	19 x 1,25	60
ABIR028	26 - 28	3/4"	19 x 1,25	60
ABIR035	32 - 35	1"	19 x 1,25	60
ABIR040	40 - 43	1 1/4"	19 x 1,25	60
ABIR048	48 - 51	1 1/2"	19 x 1,25	60
ABIR054	52 - 56	-	19 x 1,25	60
ABIR060	57 - 60	2"	19 x 1,25	60

AB-RI / AB-RE

Abrazadera isofónica reforzada M8 + M10

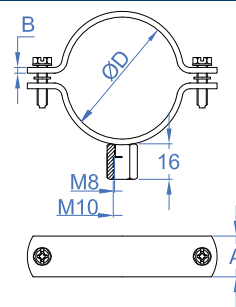
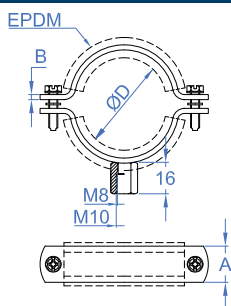

AB-RI / AB-RE

Cincada

CÓDIGO	ØD(MM)	ØD(")	A X B	CARGA MÁXIMA
ABRI018 / ABRE018	15 - 19	3/8"	18,5x1,35	80
ABRI022 / ABRE022	20 - 25	1/2"	18,5x1,35	80
ABRI028 / ABRE028	26 - 30	3/4"	18,5x1,35	80
ABRI035 / ABRE035	32 - 36	1"	18,5x1,35	80
ABRI040 / ABRE040	38 - 43	1 1/4"	18,5x1,35	80
ABRI048 / ABRE048	47 - 51	1 1/2"	18,5x1,35	80
ABRI054 / ABRE054	53 - 56	-	18,5x1,35	80
ABRI060 / ABRE060	60 - 64	2"	18,5x1,35	80
ABRI070 / ABRE070	68 - 72	-	18,5x1,35	80
ABRI075 / ABRE075	75 - 80	2 1/2"	18,5x1,75	150
ABRI083 / ABRE083	81 - 86	-	18,5x1,75	150
ABRI090 / ABRE090	87 - 92	3"	18,5x1,75	150
ABRI100 / ABRE100	99 - 105	3 1/2"	18,5x1,75	150
ABRI110 / ABRE110	107 - 112	-	18,5x1,75	150
ABRI115 / ABRE115	113 - 118	4"	18,5x2,3	200
ABRI125 / ABRE125	125 - 130	4 1/2"	18,5x2,3	200
ABRI133 / ABRE133	132 - 137	-	18,5x2,3	200
ABRI140 / ABRE140	138 - 142	5"	18,5x2,3	200
ABRI150 / ABRE150	148 - 152	-	18,5x2,3	200
ABRI160 / ABRE160	159 - 166	6"	18,5x2,3	200
ABRI180 / ABRE180	179 - 184	-	18,5x2,3	200
ABRI200 / ABRE200	199 - 212	-	18,5x2,3	200
ABRI220 / ABRE220	215 - 226	8"	18,5x2,3	200
ABRI250 / ABRE250	245 - 254	-	18,5x2,3	200
ABRI280 / ABRE280	278 - 284	-	18,5x2,3	200
ABRI300 / ABRE300	299 - 304	-	18,5x2,3	200
ABRI315 / ABRE315	314 - 319	-	18,5x2,3	200
ABRI355 / ABRE355	354 - 359	-	18,5x2,3	200

AB-RI V / AB-RE V

Cincada. Ventilación

CÓDIGO	ØD(MM)	ØD(")	A X B	CARGA MÁXIMA
ABRI250 / ABRE250	245 - 254	-	18,5x2,3	200
ABRI280 / ABRE280	278 - 284	-	18,5x2,3	200
ABRI300 / ABRE300	299 - 304	-	18,5x2,3	200
ABRI315 / ABRE315	314 - 319	-	18,5x2,3	200
ABRI355 / ABRE355	354 - 359	-	18,5x2,3	200
ABRI400 / ABRE400	399 - 404	-	18,5x2,3	200
ABRI450 / ABRE450	449 - 454	-	18,5x2,3	200
ABRI500 / ABRE500	499 - 504	-	18,5x2,3	200
ABRI560 / ABRE560	555 - 561	-	18,5x2,3	200
ABRI600 / ABRE600	599 - 604	-	18,5x2,3	200
ABRI630 / ABRE630	625 - 631	-	18,5x2,3	200
ABRI710 / ABRE710	705 - 711	-	18,5x2,3	200
ABRI800 / ABRE800	799 - 804	-	18,5x2,3	200
ABRI900 / ABRE900	899 - 904	-	18,5x2,3	200
ABRI910 / ABRE910	999 - 1.004	-	18,5x2,3	200
ABRI911 / ABRE911	1.115 - 1.121	-	18,5x2,3	200
ABRI912 / ABRE912	1.245 - 1.251	-	18,5x2,3	200

AB-RI A2 / AB-RI A4 Abrazadera isofónica reforzada M8 + M10



AB-RI A2 / AB-RI A4 Inoxidable A2

CÓDIGO	ØD(MM)	ØD(")	A X B	CARGA MÁXIMA
ABRIA2018 / ABRIA4018	15 - 18	3/8"	18,5X1,7	150
ABRIA2022 / ABRIA4022	20 - 24	1/2"	18,5X1,7	150
ABRIA2028 / ABRIA4028	26 - 30	3/4"	18,5X1,7	150
ABRIA2035 / ABRIA4035	32 - 36	1"	18,5X1,7	150
ABRIA2040 / ABRIA4040	36 - 42	1 1/4"	18,5X1,7	150
ABRIA2048 / ABRIA4048	47 - 50	1 1/2"	18,5X1,7	150
ABRIA2054 / ABRIA4054	51 - 55	-	18,5X1,7	150
ABRIA2060 / ABRIA4060	60 - 64	2"	18,5X1,7	150
ABRIA2075 / ABRIA4075	75 - 80	2 1/2"	18,5X1,7	150
ABRIA2090 / ABRIA4090	87 - 92	3"	18,5X1,7	150
ABRIA2110 / ABRIA4110	106 - 112	-	18,5X1,7	150
ABRIA2115 / ABRIA4115	114 - 119	4"	18,5X1,7	150
ABRIA2125 / ABRIA4125	124 - 131	4 1/2"	18,5X1,7	150
ABRIA2140 / ABRIA4140	133 - 140	5"	18,5X1,7	150
ABRIA2160 / ABRIA4160	159 - 163	6"	18,5X1,7	150

AB-RE A2 / AB-RE A4 Abrazadera reforzada M8 + M10



AB-RE A2 / AB-RE A4 Inoxidable A2

CÓDIGO	ØD(MM)	ØD(")	A X B	CARGA MÁXIMA
ABREA2018 / ABREA4018	15 - 18	3/8"	18,5X1,7	150
ABREA2022 / ABREA4022	20 - 24	1/2"	18,5X1,7	150
ABREA2028 / ABREA4028	26 - 30	3/4"	18,5X1,7	150
ABREA2035 / ABREA4035	32 - 36	1"	18,5X1,7	150
ABREA2040 / ABREA4040	36 - 42	1 1/4"	18,5X1,7	150
ABREA2048 / ABREA4048	47 - 50	1 1/2"	18,5X1,7	150
ABREA2054 / ABREA4054	51 - 55	-	18,5X1,7	150
ABREA2060 / ABREA4060	60 - 64	2"	18,5X1,7	150
ABREA2075 / ABREA4075	75 - 80	2 1/2"	18,5X1,7	150
ABREA2090 / ABREA4090	87 - 92	3"	18,5X1,7	150
ABREA2110 / ABREA4110	106 - 112	-	18,5X1,7	150
ABREA2115 / ABREA4115	114 - 119	4"	18,5X1,7	150
ABREA2125 / ABREA4125	124 - 131	4 1/2"	18,5X1,7	150
ABREA2140 / ABREA4140	133 - 140	5"	18,5X1,7	150
ABREA2160 / ABREA4160	159 - 163	6"	18,5X1,7	150
ABREA2200 / ABREA4200	199 - 212	-	18,5X1,7	150

AB-GA

Abrazadera gásmica M8 + M10 amarilla

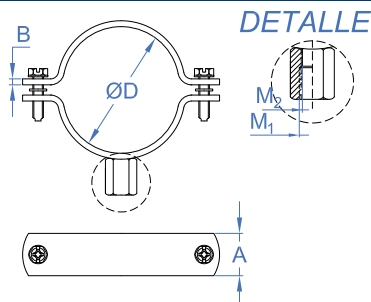

AB-GA

Abrazadera gásmica M8 + M10 amarilla

CÓDIGO	ØD(MM)	ØD(")	A X B	MÉTRICA	CARGA MÁXIMA
ABGA018	15 - 18	3/8"	20 x 2	M8	200
ABGA022	20 - 24	1/2"	20 x 2	M8	200
ABGA028	26 - 30	3/4"	20 x 2	M8	200
ABGA035	32 - 36	1"	20 x 2	M8	200
ABGA040	38 - 42	1 1/4"	20 x 2	M8	200
ABGA048	47 - 50	1 1/2"	20 x 2	M8	200
ABGA054	52 - 56	-	20 x 2	M8	200
ABGA060	60 - 64	2"	20 x 2	M8/M10	200
ABGA075	75 - 80	2 1/2"	20 x 2	M8/M10	200
ABGA090	85 - 90	3"	20 x 2	M8/M10	200
ABGA100	99 - 105	3 1/2"	20 x 2	M8/M10	200
ABGA110	107 - 112	-	20 x 2	M8/M10	200
ABGA115	113 - 118	4"	20 x 2	M8/M10	200
ABGA140	138 - 142	5"	20 x 2	M8/M10	200
ABGA160	159 - 166	6"	20 x 2	M8/M10	200

AB-M8

Abrazadera desagüe M8

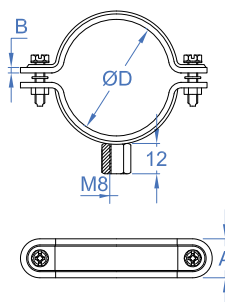

AB-M8

Abrazadera desagüe M8

CÓDIGO	ØD(MM)	ØD(")	A X B	CARGA MÁXIMA
ABM8050	49 - 54	-	28 x 0,8	100
ABM8063	60 - 65	-	28 x 0,8	100
ABM8075	75 - 80	-	28 x 0,8	100
ABM8090	88 - 92	-	28 x 0,8	100
ABM8110	108 - 113	-	28 x 0,8	100
ABM8125	124 - 130	-	28 x 0,8	100
ABM8160	159 - 165	-	28 x 0,8	100
ABM8200	199 - 203	-	28 x 0,8	100
ABM8250	249 - 254	-	28 x 0,8	100
ABM8315	314 - 319	-	28 x 0,8	100

AB-DE Z / AB-DE G Abrazadera desagüe de empotrar

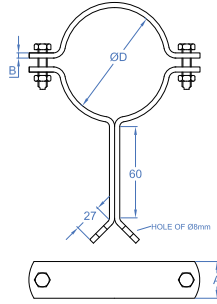

AB-DE Z / AB-DE G Zincada / Galvanizada

CÓDIGO	ØD(MM)	ØD(°)	A X B	CARGA MÁXIMA
ABDE075	75 - 80	2 1/2"	20 x 2,5	200
ABDE090	87 - 92	3"	20 x 2,5	200
ABDE110	107 - 112	-	20 x 2,5	200
ABDE125	125 - 130	4 1/2"	20 x 2,5	200
ABDE160	159 - 166	6"	20 x 2,5	200
ABDE200	199 - 212	-	20 x 2,5	200
ABDE250	245 - 254	-	20 x 2,5	200
ABDE315	314 - 319	-	20 x 2,5	200

AB-DP Z / AB-DP G Abrazadera desagüe con pie

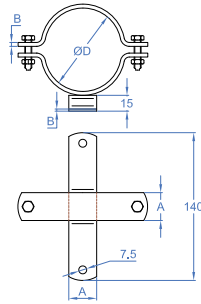

AB-DP Z / AB-DP G Zincada / Galvanizada

CÓDIGO	ØD(MM)	ØD(°)	A X B	CARGA MÁXIMA
ABDP075	75 - 80	2 1/2"	20 x 2	200
ABDP090	87 - 92	3"	20 x 2	200
ABDP110	107 - 112	-	20 x 2	200
ABDP125	125 - 130	4 1/2"	20 x 2	200
ABDP160	159 - 166	6"	20 x 2	200
ABDP200	199 - 212	-	20 x 2	200
ABDP250	245 - 254	-	20 x 2	200

AB-ZI

Abarcón

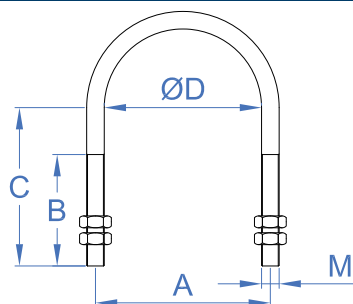

AB-ZI

Cincada

CÓDIGO	ØD(")	MÉTRICA	A X B X C	CARGA MÁXIMA
AZIM060250	1/4"	M6	20 / 14 / 20	250
AZIM060375	3/8"	M6	23,5 / 15 / 23	250
AZIM060500	1/2"	M6	27,5 / 17 / 25	250
AZIM060750	3/4"	M6	33 / 19 / 31	250
AZIM061000	1"	M6	39,5 / 24 / 39	250
AZIM061250	1 1/4"	M6	48,5 / 24 / 44	250
AZIM081500	1 1/2"	M8	56,5 / 26 / 48	350
AZIM082000	2"	M8	68,5 / 26 / 53	350
AZIM082250	2 1/4"	M8	83 / 35 / 63	350
AZIM082500	2 1/2"	M8	83 / 35 / 71	350
AZIM083000	3"	M8	99 / 35 / 76	350
AZIM083500	3 1/2"	M8	112 / 35 / 82	350
AZIM084000	4"	M8	125 / 35 / 87	350
AZIM084500	4 1/2"	M8	140 / 40 / 100	350
AZIM085000	5"	M8	152 / 40 / 105	350
AZIM086000	6"	M8	179 / 40 / 118	350
AZIM103000	3"	M10	100 / 45 / 66	350
AZIM103500	3 1/2"	M10	110 / 50 / 94	350
AZIM104000	4"	M10	125 / 55 / 97,5	350
AZIM105000	5"	M10	150 / 55 / 108	350
AZIM106000	6"	M10	170 / 55 / 125	350
AZIM108000	8"	M10	230 / 55 / 148	350

AB-SA

Soporte de abarcón

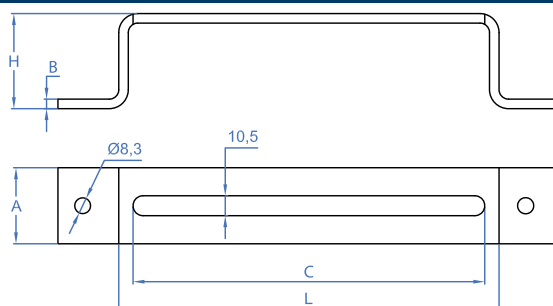

AB-SA

Soporte de abarcón

CÓDIGO	L	H	A X B	C
ABSA050100	100	50	40 x 5	85
ABSA050125	125	50	40 x 5	110
ABSA050200	200	50	40 x 5	185
ABSA050300	300	50	40 x 5	285
ABSA050400	400	50	40 x 5	385
ABSA050500	500	50	40 x 5	485
ABSA050600	600	50	40 x 5	585
ABSA100100	100	100	40 x 5	85
ABSA100125	125	100	40 x 5	110
ABSA100200	200	100	40 x 5	185
ABSA100300	300	100	40 x 5	285
ABSA100400	400	100	40 x 5	385
ABSA100500	500	100	40 x 6	485

AB-GP

Abrazadera de gran presión

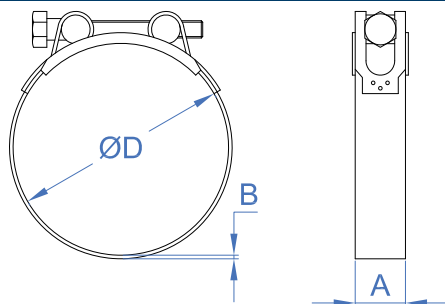

AB-GP

Abrazadera de gran presión

CÓDIGO	M X L	ØD(MM)	A X B
AGP023025	M5 x 35	23 - 25	18 X 0,6
AGP026028	M5 x 35	26 - 28	18 X 0,6
AGP029031	M5 x 35	29 - 31	18 X 0,6
AGP032035	M6 x 50	32 - 35	20 X 1
AGP036039	M6 x 50	36 - 39	20 X 1
AGP040043	M6 x 50	40 - 43	20 X 1
AGP044047	M6 x 50	44 - 47	20 X 1
AGP048051	M6 x 50	48 - 51	20 X 1
AGP052055	M6 x 50	52 - 55	20 X 1
AGP056059	M6 x 55	56 - 59	20 X 1
AGP060063	M6 x 55	60 - 63	20 X 1
AGP064067	M8 x 70	64 - 67	25 X 1,5
AGP068073	M8 x 70	68 - 73	25 X 1,5
AGP074079	M8 x 70	74 - 79	25 X 1,5
AGP080085	M8 x 70	80 - 85	25 X 1,5
AGP086091	M8 x 70	86 - 91	25 X 1,5
AGP092097	M8 x 70	92 - 97	25 X 1,5
AGP098103	M8 x 70	98 - 103	25 X 1,5
AGP104112	M8 x 80	104 - 112	25 X 1,5
AGP113121	M8 x 80	113 - 121	25 X 1,5
AGP122130	M8 x 80	122 - 130	25 X 1,5
AGP131139	M8 x 80	131 - 139	25 X 1,5
AGP140148	M8 x 80	140 - 148	25 X 1,5
AGP149161	M8 x 80	149 - 161	25 X 1,8
AGP162174	M8 x 80	162 - 174	25 X 1,8
AGP175187	M10 x 110	175-187	25 X 1,8
AGP188200	M10 x 110	188-200	25 X 1,8
AGP201213	M10 x 110	201-213	25 X 1,8
AGP214226	M10 x 110	214-226	25 X 1,8

AB-M6

Abrazadera M6

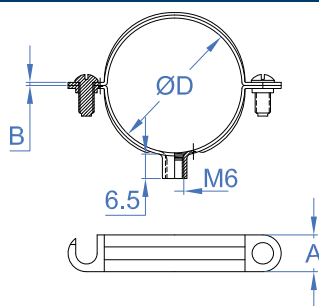

AB-M6 Z / AB-M6 Cincada

CÓDIGO	ØD(MM)	ØD(")	A X B	CARGA MÁXIMA
ABM6008 / ABMZ6008	8	-	10 x 1	70
ABM6010 / ABMZ6010	10	1/8"	10 x 1	70
ABM6012 / ABMZ6012	12	-	10 x 1	70
ABM6014 / ABMZ6014	14	1/4"	10 x 1	70
ABM6015 / ABMZ6015	15	-	10 x 1	70
ABM6016 / ABMZ6016	16	-	10 x 1	70

CÓDIGO	ØD(MM)	ØD(")	A X B	CARGA MÁXIMA
ABM6018 / ABMZ6018	18	3/8"	10 x 1	70
ABM6020 / ABMZ6020	20	-	10 x 1	70
ABM6022 / ABMZ6022	22	1/2"	10 x 1	70
ABM6025 / ABMZ6025	25	-	10 x 1	70
ABM6026 / ABMZ6026	26	3/4"	10 x 1	70
ABM6028 / ABMZ6028	28	-	10 x 1	70
ABM6032 / ABMZ6032	32	1"	10 x 1	70
ABM6035 / ABMZ6035	35	-	12 x 1,2	70
ABM6037 / ABMZ6037	37	-	12 x 1,2	100
ABM6040 / ABMZ6040	40	-	12 x 1,2	100
ABM6042 / ABMZ6042	42	1 1/4"	12 x 1,2	100
ABM6047 / ABMZ6047	47	1 1/2"	12 x 1,2	100
ABM6050 / ABMZ6050	50	-	12 x 1,2	100
ABM6054 / ABMZ6054	54	-	12 x 1,2	100
ABM6060 / ABMZ6060	60	2"	12 x 1,2	100
ABM6063 / ABMZ6063	63	-	12 x 1,2	100

AB-D6 Abrazadera doble M6

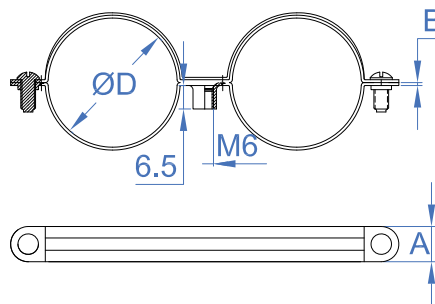

AB-D6 Z / AB-D6 Cincada

CÓDIGO	ØD(MM)	ØD(")	A X B	CARGA MÁXIMA
ABD6012 / ABDZ6012	12	1/8"	12 x 1	100
ABD6015 / ABDZ6015	15	1/4"	12 x 1,2	100
ABD6018 / ABDZ6018	18	3/8"	12 x 1,2	100
ABD6022 / ABDZ6022	22	1/2"	12 x 1,2	100
ABD6028 / ABDZ6028	28	3/4"	12 x 1,2	100

AB-M6 A2 Abrazadera M6

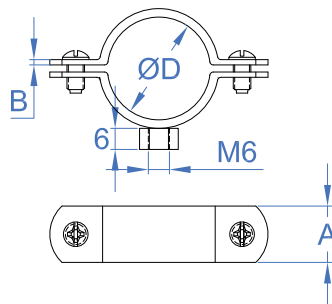

AB-M6 A2 Inoxidable A2

CÓDIGO	ØD(MM)	ØD(")	A X B	CARGA MÁXIMA
ABM6A2012	12	1/4"	16 x 1,5	70
ABM6A2015	14 - 15	-	16 x 1,5	70
ABM6A2018	16 - 18	3/8"	16 x 1,5	70
ABM6A2020	19 - 21	1/2"	16 x 1,5	70
ABM6A2022	22 - 24	-	16 x 1,5	70
ABM6A2028	25 - 30	3/4"	16 x 1,5	70

AB-6I

Abrazadera isofónica M6

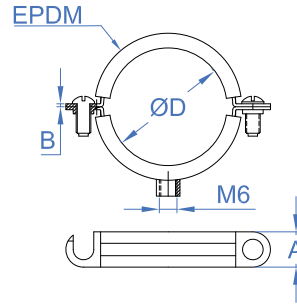

AB-6I

Abrazadera isofónica M6

CÓDIGO	ØD(MM)	ØD(ʹ)	A X B	CARGA MÁXIMA
AB6I012	12	1/8"	15 x 1,2	70
AB6I015	15	1/4"	15 x 1,2	70
AB6I016	16	-	15 x 1,2	70
AB6I018	18	3/8"	15 x 1,2	70
AB6I022	22	1/2"	15 x 1,2	70
AB6I026	26	-	15 x 1,2	70
AB6I028	28	3/4"	15 x 1,2	70
AB6I032	32	-	15 x 1,2	70
AB6I035	35	1"	15 x 1,2	70
AB6I042	42	1 1/4"	15 x 1,2	100
AB6I048	48	1 1/2"	15 x 1,2	100
AB6I054	54	-	15 x 1,2	100
AB6I060	60	2"	15 x 1,2	100

AB-DI

Abrazadera doble isofónica M6

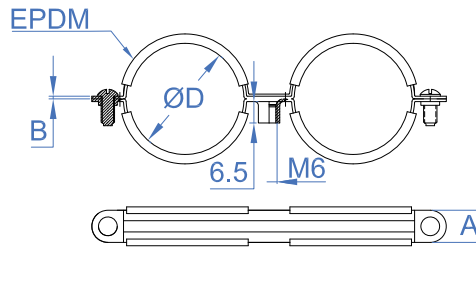

AB-DI

Abrazadera M6. Bicromatada

CÓDIGO	ØD(MM)	ØD(ʹ)	A X B	CARGA MÁXIMA
ABDI0012	12	1/8"	15 x 1	100
ABDI0015	15	1/4"	15 x 1,2	100
ABDI0018	18	3/8"	15 x 1,2	100
ABDI0022	22	1/2"	15 x 1,2	100
ABDI0028	28	3/4"	15 x 1,2	100

AB-M7

Abrazadera M6

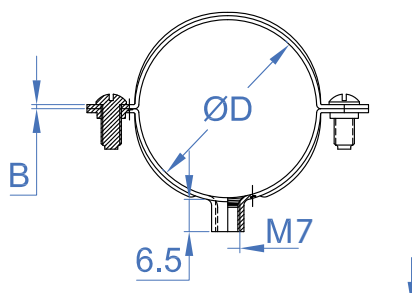

AB-M7 Z

Cincada

CÓDIGO	ØD(MM)	ØD(")	A X B	CARGA MÁXIMA
ABMZ7008	8	-	11 X 1	-
ABMZ7010	10	1/8"	11 X 1	-
ABMZ7012	12	-	11 X 1	-
ABMZ7014	14	1/4"	11 X 1	-
ABMZ7016	16	-	11 X 1	-
ABMZ7018	18	3/8"	11 X 1	-
ABMZ7020	20	-	11 X 1	-
ABMZ7022	22	1/2"	11 X 1	-
ABMZ7024	24	-	11 X 1	-
ABMZ7025	25	-	11 X 1	-
ABMZ7026	26	3/4"	11 X 1	-
ABMZ7028	28	-	11 X 1	-
ABMZ7032	32	1"	11 X 1	-
ABMZ7034	34	-	11 X 1	-
ABMZ7036	36	-	11 X 1	-
ABMZ7038	38	-	11 X 1	-
ABMZ7040	40	-	11 X 1	-
ABMZ7050	50	-	11 X 1	-
ABMZ7063	63	-	12 X 1,2	-

AB-D7

Abrazadera doble M6

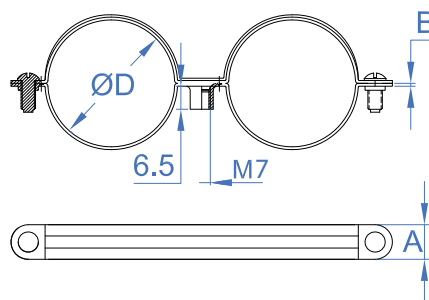

AB-D7 Z

Cincada

CÓDIGO	ØD(MM)	ØD(")	A X B	CARGA MÁXIMA
ABDZ70810	8-10	-	11 X 1	-
ABDZ71012	10-12	1/8"	11 X 1	-
ABDZ71214	12-14	-	11 X 1	-
ABDZ71416	14-16	-	11 X 1	-
ABDZ71618	16-18	3/8"	11 X 1	-
ABDZ71820	18-20	-	11 X 1	-
ABDZ72022	20-22	1/2"	11 X 1	-
ABDZ72224	22-24	-	11 X 1	-
ABDZ72628	26-28	3/4"	11 X 1	-

AB-7I

Abrazadera isofónica M6

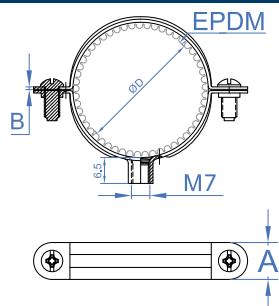

AB-7I Z

Abrazadera isofónica M6

CÓDIGO	ØD(MM)	ØD(")	A X B	CARGA MÁXIMA
AB7IZ010	10	-	11 X 1	-
AB7IZ012	12	-	11 X 1	-
AB7IZ014	14	-	11 X 1	-
AB7IZ016	16	-	11 X 1	-
AB7IZ018	18	-	11 X 1	-
AB7IZ020	20	-	11 X 1	-
AB7IZ022	22	-	11 X 1	-
AB7IZ024	24	-	11 X 1	-
AB7IZ026	26	-	11 X 1	-
AB7IZ028	28	-	11 X 1	-
AB7IZ032	32	-	11 X 1	-
AB7IZ034	34	-	11 X 1	-
AB7IZ036	36	-	12 X 1	-
AB7IZ038	38	-	12 X 1	-
AB7IZ040	40	-	12 X 1	-
AB7IZ050	50	-	12 X 1,2	-

AB-7ID

Abrazadera doble isofónica M6

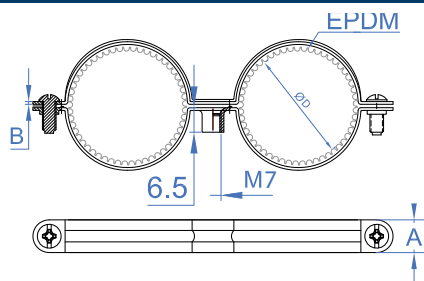

AB-7ID Z

Abrazadera M6. Bicromatada

CÓDIGO	ØD(MM)	ØD(")	A X B	CARGA MÁXIMA
AB7IDZ0810	08-10	1/8"	11 X 1	-
AB7IDZ1012	10-12	1/8"	11 X 1	-
AB7IDZ1214	12-14	1/4"	11 X 1	-
AB7IDZ1416	14-16	1/4"	11 X 1	-
AB7IDZ1618	16-18	3/8"	11 X 1	-
AB7IDZ1820	18-20	3/8"	11 X 1	-
AB7IDZ2022	20-22	1/2"	11 X 1	-
AB7IDZ2224	22-24	1/2"	11 X 1	-
AB7IDZ2628	26-28	3/4"	11 X 1	-

AB-PI

Grapa 1 pie

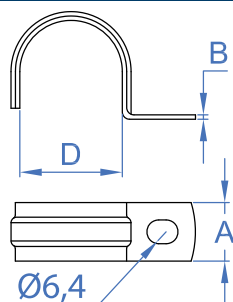

AB-PI

Abrazadera de un pie

CÓDIGO	Ø(D)(MM)	Ø(D)(")	A X B	CARGA MÁXIMA
ABPI006	6	-	12 x 1	30
ABPI008	8	-	12 x 1	30
ABPI010	10	1/8"	12 x 1	30
ABPI012	12	-	12 x 1	30
ABPI014	14	1/4"	15 x 1	30
ABPI016	16	-	15 x 1	30
ABPI018	18	3/8"	15 x 1	30
ABPI020	20	-	15 x 1	30
ABPI022	22	1/2"	15 x 1,2	30
ABPI025	25	-	15 x 1,2	30
ABPI026	26	3/4"	15 x 1,2	30
ABPI028	28	-	15 x 1,2	30
ABPI032	32	1"	15 x 1,2	30
ABPI040	40	-	15 x 1,2	30
ABPI042	42	1 1/4"	15 x 1,2	30
ABPI047	47	1 1/2"	15 x 1,2	30
ABPI050	50	-	15 x 1,2	30
ABPI063	63	2"	15 x 1,2	30

AB-PU

Grapa puente

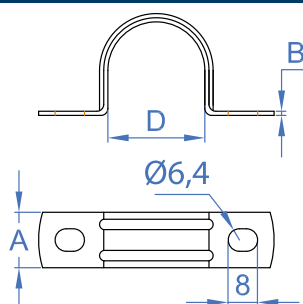

AB-PU

Abrazadera grapa puente

CÓDIGO	Ø(D)(MM)	Ø(D)(")	A X B	CARGA MÁXIMA
ABPU016	16	-	12 x 1,2	75
ABPU018	18	3/8"	12 x 1,2	75
ABPU020	20	-	12 x 1,2	75
ABPU022	22	1/2"	15 x 1,2	75
ABPU025	25	-	15 x 1,2	75
ABPU028	28	3/4"	15 x 1,2	75
ABPU032	32	1"	15 x 1,2	75
ABPU037	37	-	18 x 1,2	75
ABPU040	40	1 1/4"	18 x 1,2	75
ABPU050	50	1 1/2"	18 x 1,2	75
ABPU063	63	2"	18 x 1,2	75

AB-IP

Grapa puente isofónica para montaje

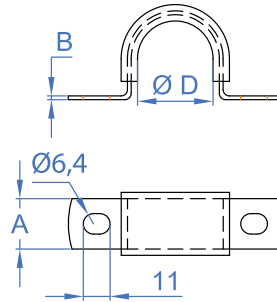

AB-IP

Abrazadera puente isofónica para montaje

CÓDIGO	ØD(MM)	ØD(")	A X B
ABIP015	15	1/4"	20 x 1,5
ABIP018	18	3/8"	20 x 1,5
ABIP022	22	1/2"	20 x 1,5
ABIP026	26	3/4"	20 x 1,5
ABIP028	28	-	20 x 1,5
ABIP035	35	1"	20 x 1,5
ABIP042	42	1 1/4"	20 x 1,5
ABIP048	48	1 1/2"	20 x 1,5
ABIP054	54	-	20 x 1,5
ABIP060	60	2"	20 x 1,5
ABIP067	67	-	20 x 1,5
ABIP075	75	2 1/2"	20 x 1,5
ABIP090	90	3"	20 x 1,5

AB-SI

Soporte para grapa puente isofónica

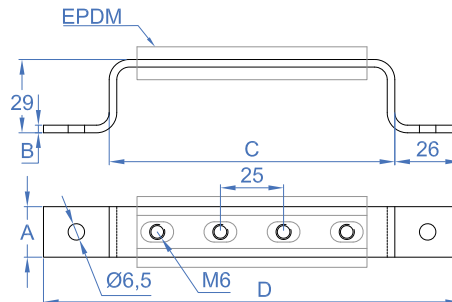

AB-SI

Soporte para grapa puente isofónica

CÓDIGO	A X B	C	D	Nº AGUJEROS
ABSI003	20 x 3	88	140	3
ABSI004	20 x 3	113	165	4
ABSI005	20 x 3	138	190	5
ABSI006	20 x 3	163	215	6
ABSI007	20 x 3	188	240	7
ABSI008	20 x 3	213	265	8
ABSI009	20 x 3	238	290	9
ABSI010	20 x 3	263	315	10
ABSI011	20 x 3	288	340	11
ABSI012	20 x 3	313	365	12
ABSI013	20 x 3	338	390	13
ABSI014	20 x 3	363	415	14
ABSI015	20 x 3	388	440	15
ABSI016	20 x 3	413	465	16
ABSI017	20 x 3	438	490	17
ABSI018	20 x 3	463	515	18
ABSI019	20 x 3	488	540	19
ABSI020	20 x 3	513	565	20
ABSI021	20 x 3	538	590	21
ABSI022	20 x 3	563	615	22
ABSI025	20 x 3	638	690	25

AB-SF

Abrazadera sin fin

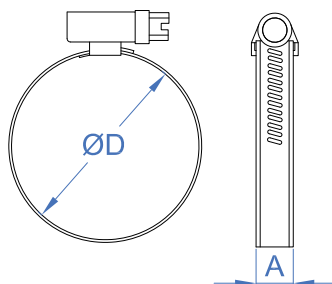

AB-SF

Cincada

CÓDIGO	ØD(MM)	ØD(")	AXB	PAR DE APRIETE
ASF008016	8-16	5/16"- 5/8"	9 x 0,7	4,5
ASF012022	12-22	1/2"- 7/8"	9 x 0,7	4,5
ASF016027	16 - 27	5/8"- 1 1/16"	9 x 0,7	4,5
ASF020032	20 - 32	3/4"- 1 1/4"	9 x 0,7	4,5
ASF025040	25 - 40	1"- 1 5/8"	9 x 0,7	4,5
ASF030045	30 - 45	1 3/16"- 1 3/4"	9 x 0,8	4,5
ASF035050	35 - 50	1 3/8"- 2"	9 x 0,8	4,5
ASF040060	40 - 60	1 5/8"- 2 3/8"	9 x 0,8	4,5
ASF050070	50 - 70	2"- 2 3/4"	9 x 0,8	4,5
ASF060080	60 - 80	2 3/8"- 3 1/8"	9 x 0,8	4,5
ASF070090	70 - 90	2 3/4"- 3 1/2"	9 x 0,8	4,5
ASF080100	80 - 100	3 1/8"- 4"	9 x 0,8	4,5
ASF090110	90 - 110	3 1/2"- 4 3/8"	9 x 0,8	4,5
ASF100120	100 - 120	4"- 4 3/4"	9 x 0,8	4,5
ASF110130	110 - 130	4 3/8"- 5 1/8"	9 x 0,8	4,5
ASF120140	120 - 140	4 3/4"- 5 1/2"	9 x 0,8	4,5
ASF130150	130 - 150	5 1/8"- 5 7/8"	9 x 0,8	4,5

AB-SF A2

Inoxidable A2

CÓDIGO	ØD(MM)	ØD(")	AXB	PAR DE APRIETE
ASF2010016	10-16	5/16"- 5/8"	9 x 0,7	4
ASF2012020	12-20	1/2"- 7/8"	9 x 0,7	4
ASF2016027	16 - 27	5/8"- 1 1/16"	9 x 0,7	4
ASF2020032	20 - 32	3/4"- 1 1/4"	9 x 0,7	4
ASF2025040	25 - 40	1"- 1 5/8"	9 x 0,7	4
ASF2032050	32 - 50	1 3/8"- 2"	9 x 0,7	4
ASF2040060	40 - 60	1 5/8"- 2 3/8"	9 x 0,7	4
ASF2050070	50 - 70	2"- 2 3/4"	9 x 0,7	4
ASF2060080	60 - 80	2 3/8"- 3 1/8"	9 x 0,7	4
ASF2070090	70 - 90	2 3/4"- 3 1/2"	9 x 0,7	4
ASF2080100	80 - 100	3 1/8"- 4"	9 x 0,7	4
ASF2090110	90 - 110	3 1/2"- 4 3/8"	9 x 0,7	4
ASF2100120	100 - 120	4"- 4 3/4"	9 x 0,7	4
ASF2110130	110 - 130	4 3/8"- 5 1/8"	9 x 0,7	4
ASF2120140	120 - 140	4 3/4"- 5 1/2"	9 x 0,7	4
ASF2130150	130 - 150	5 1/8"- 5 7/8"	9 x 0,7	4

CI-PE

Cinta perforada

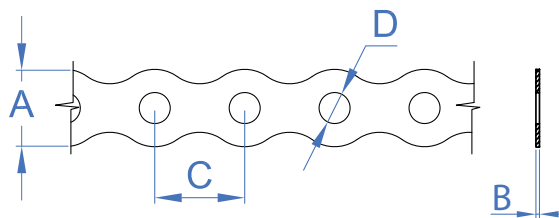

CI-PE

Cinta perforada curva. ATLANTIS C2-M

CÓDIGO	AXB	c	D
CIPE1208	12 x 0,8	14	5
CIPE1708	17 x 0,8	20	7

CI-PE A2

Cinta perforada curva. Inoxidable A2

CÓDIGO	AXB	c	D
CIPEA21708	17 x 0,8	20	7

CI-PR

Cinta perforada recta ATLANTIS C2-M

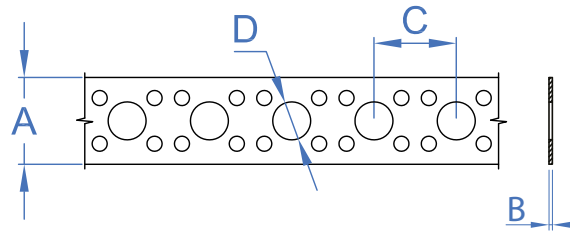

CI-PR

Cinta perforada recta ATLANTIS C2-M

CÓDIGO	A X B	c	D
CIPR1908	19 x 0,8	18	8,3
CIPR1208	12 x 0,8	12	6,2

AB-CR

Abrazadera cromada M6

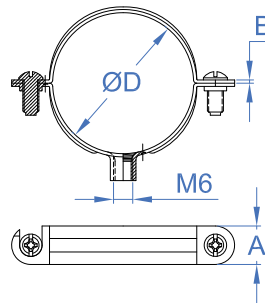

AB-CR

Abrazadera cromada M6

CÓDIGO	ØD(MM)	ØD(°)	A X B	CARGA MÁXIMA
ABCR010	10	1/8"	12 x 1,2	70
ABCR012	12	1/4"	12 x 1,2	70

AB-BU

Abrazadera butano

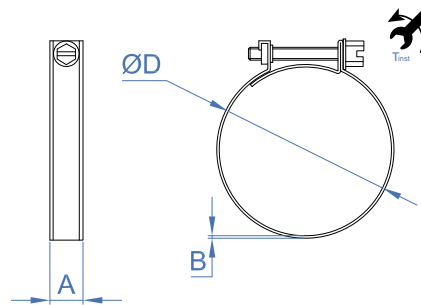

AB-BU

Abrazadera butano

CÓDIGO	ØD(MM)	ØD(°)	A X B	PAR DE APRIETE
ABBU1315	13-15	1/2" - 9/16"	9 x 0,6	2
ABBU1618	16-18	5/8" - 11/16"	9 x 0,6	2
ABBU1921	19-21	3/4" - 13/16"	9 x 0,6	2

AB-GM

Abrazadera gásmica con tirafondo amarilla

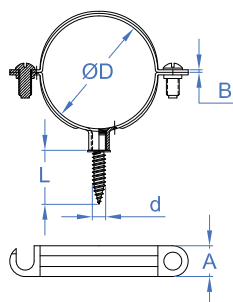

AB-GM

Abrazadera gásmica amarilla M6 con tirafondo

CÓDIGO	ØD(MM)	ØD(")	A X B	CARGA MÁXIMA
ABGM012	12	1/8"	12 x 1,2	70
ABGM015	15	1/4"	12 x 1,2	70
ABGM018	18	3/8"	12 x 1,2	70
ABGM022	22	1/2"	12 x 1,2	70
ABGM028	28	3/4"	12 x 1,2	70
ABGM035	35	1"	12 x 1,2	70

AB-GS

Abrazadera gásmica negra M6 con tirafondo

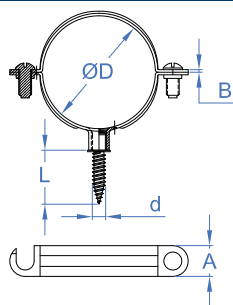

AB-GS

Abrazadera gásmica negra M6 con tirafondo

CÓDIGO	ØD(MM)	ØD(")	A X B	CARGA MÁXIMA
ABGS010	10	1/8"	12 x 1,2	70
ABGS012	12	-	12 x 1,2	70
ABGS015	15	1/4"	12 x 1,2	70
ABGS018	18	3/8"	12 x 1,2	70
ABGS022	22	1/2"	12 x 1,2	70
ABGS028	28	3/4"	12 x 1,2	70
ABGS035	35	1"	12 x 1,2	70
ABGS042	42	1 1/4"	12 x 1,2	70
ABGS054	54	-	12 x 1,2	70

AB-GD

Abrazadera gásmica negra doble M6 con tirafondo

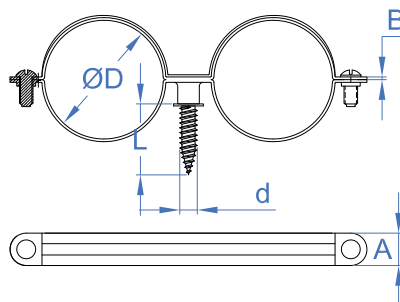

AB-GD

Abrazadera gásmica negra doble M6 con tirafondo

CÓDIGO	ØD(MM)	ØD(")	A X B	CARGA MÁXIMA
ABGD012	12	1/8"	12 x 1,2	100
ABGD015	15	1/4"	12 x 1,2	100
ABGD018	18	3/8"	12 x 1,2	100
ABGD022	22	1/2"	12 x 1,2	100
ABGD028	28	3/4"	12 x 1,2	100

AB-PE

Abrazadera colgante pera

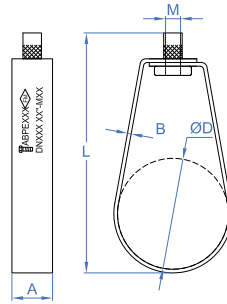

AB-PE

Abrazadera colgante pera

CÓDIGO	ØD(MM)	ØD(")	A X B	LONGITUD	MEDIDA TORNILLO	CARGA MÁXIMA
ABPE028	DN 20	3/4"	21 x 1	72	M10 (3/8")	154
ABPE035	DN 25	1"	21 x 1	78	M10 (3/8")	186
ABPE040	DN 32	1 1/4"	21 x 1	88	M10 (3/8")	195
ABPE048	DN 40	1 1/2"	21 x 1,2	95	M10 (3/8")	236
ABPE060	DN 50	2"	21 x 1,2	105	M10 (3/8")	288
ABPE075	DN 65	2 1/2"	21 x 1,2	125	M10 (3/8")	426
ABPE090	DN 80	3"	21 x 1,2	140	M10 (3/8")	481
ABPE100	DN 90	3 1/2"	21 x 1,2	160	M10 (3/8")	569
ABPE115	DN 100	4"	21 x 2	173	M10 (3/8")	669
ABPE140	DN 125	5"	30 x 2	209	M12 (1/2")	907
ABPE160	DN 150	6"	30 x 2,5	249	M12 (1/2")	1186
ABPE220	DN 200	8"	35 x 2,5	309	M12 (1/2")	1723

AB-CH

Abrazadera desagüe M8

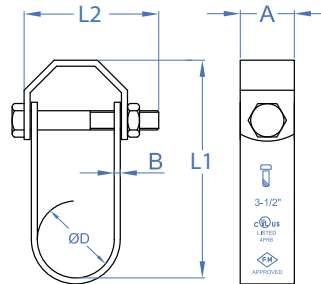

AB-CH

Abrazadera desagüe M8

CÓDIGO	ØD(MM)	ØD(")	A X B	L1	L2	CARGA MÁXIMA
ABCH00034	28	3/4"	22,5 x 2,5	82,5	50	-
ABCH01000	35	1"	22,5 x 2,5	99	57	-
ABCH01014	42	1 1/4"	22,5 x 2,5	106	70	-
ABCH01012	48	1 1/2"	22,5 x 2,5	107	75	-
ABCH02000	60	2"	25,5 x 2,5	126	90	-
ABCH02012	75	2 1/2"	26,0 x 3,0	156	110	-
ABCH03000	90	3"	26,0 x 3,0	169	115	-
ABCH04000	115	4"	30,0 x 4,0	200	15	-
ABCH05000	140	5"	32,0 x 4,5	231	200	-
ABCH06000	160	6"	36,5 x 4,5	260	225	-
ABCH08000	220	8"	42,5 x 4,5	329	280	-
ABCH10000	275	10"	44,5 x 6,0	381	360	-
ABCH12000	325	12"	50,0 x 6,0	457	410	-
ABCH14000	355	14"	50,0 x 6,0	514	465	-
ABCH16000	405	16"	64,0 x 6,0	560	520	-

AB-IN

Clip simple de polipropileno con casquillo de latón M6

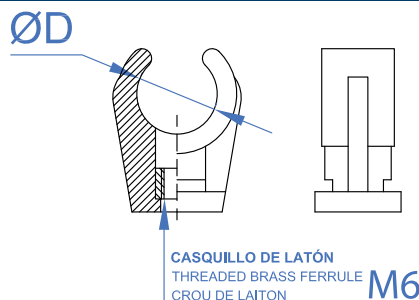

AB-IN

Clip simple de polipropileno con casquillo de latón M6

CÓDIGO	ØD(MM)	ØD(")	VÁLIDO PARA	CARGA MÁXIMA
ABIN012	12	1/4"	Carril 20/10	-
ABIN014	14-15	3/8"	Carril 20/10	-
ABIN016	16-18	-	Carril 20/10	-
ABIN020	20-22	-	Carril 20/10	-
ABIN025	25	-	Carril 20/10	-
ABIN028	28	3/4"	Carril 20/10	-
ABIN032	32	-	Carril 20/10	-
ABIN035	35	-	Carril 20/10	-

AB-ID

Clip doble de polipropileno con casquillo de latón M6

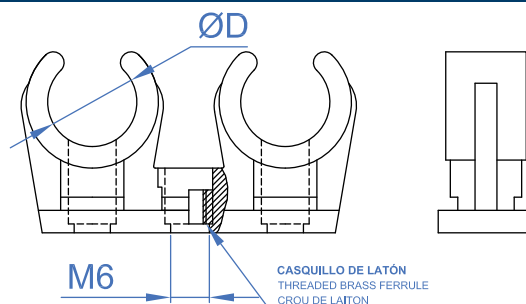

AB-ID

Clip doble de nylon (poliamida 6.6) con casquillo de latón M6

CÓDIGO	ØD(MM)	ØD(")	VÁLIDO PARA	CARGA MÁXIMA
ABID012	12	1/4"	Carril 20/10	-
ABID014	14-15	3/8"	Carril 20/10	-
ABID016	16-18	-	Carril 20/10	-
ABID020	20-22	-	Carril 20/10	-
ABID028	28	3/4"	Carril 20/10	-

AB-GU

Abrazadera guía simple con pre-rosca M6

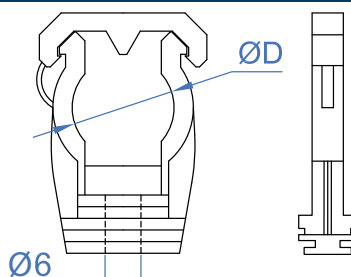

AB-GU

Abrazadera guía gris simple con pre-rosca M6

CÓDIGO	ØD(MM)	ØD(")	VÁLIDO PARA	CARGA MÁXIMA
ABGUG12	12	1/4"	20/10 27/18 28/30	-
ABGUG15	15	3/8"	20/10 27/18 28/30	-
ABGUG18	18	-	20/10 27/18 28/30	-
ABGUG20	20	-	20/10 27/18 28/30	-
ABGUG22	22	1/2"	20/10 27/18 28/30	-
ABGUG25	25	-	20/10 27/18 28/30	-
ABGUG28	28	-	20/10 27/18 28/30	-
ABGUG32	32	1"	20/10 27/18 28/30	-
ABGUG40	40	-	20/10 27/18 28/30	-
ABGUG50	50	-	20/10 27/18 28/30	-

AB-MUG

Abrazadera multidímetro

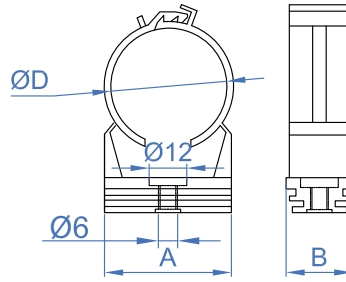

AB-MUG

Abrazadera multiusos

CÓDIGO	ØD(MM)	Ød(*)	A X B	VÁLIDO PARA	CARGA MÁXIMA
ABMUG12	12	-	17 x 20	20/10 27/18 28/30	-
ABMUG15	15	-	21 x 20	20/10 27/18 28/30	-
ABMUG18	18	-	25 x 20	20/10 27/18 28/30	-
ABMUG22	22	-	30 x 20	20/10 27/18 28/30	-
ABMUG26	26	-	33 x 20	20/10 27/18 28/30	-
ABMUG32	32	-	38 x 20	20/10 27/18 28/30	-
ABMUG40	40	-	46 x 20	20/10 27/18 28/30	-
ABMUG48	42	-	56 x 20	20/10 27/18 28/30	-

AB-PR

Abrazadera a presión con pre-rosca M6

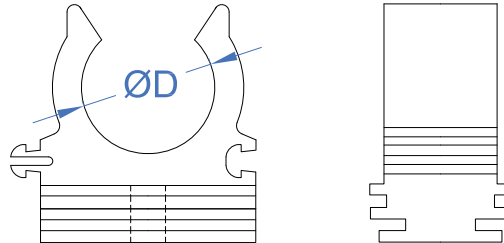

AB-PR

Gris

CÓDIGO	ØD(MM)	Ød(*)	VÁLIDO PARA	CARGA MÁXIMA
ABPRG12	12	1/4"	20/10 27/18 28/30	-
ABPRG15	15-18	3/8"	20/10 27/18 28/30	-
ABPRG20	20-22	-	20/10 27/18 28/30	-
ABPRG25	25-28	1/2"	20/10 27/18 28/30	-
ABPRG32	32-35	-	20/10 27/18 28/30	-
ABPRG40	40	-	20/10 27/18 28/30	-
ABPRG50	50	3/4"	20/10 27/18 28/30	-

AB-MS

Abrazadera multitubo + taco. Simple

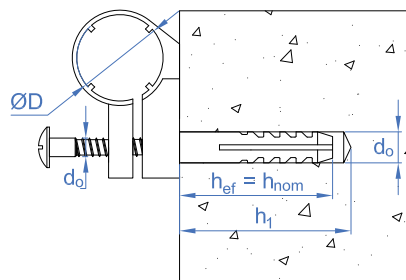

AB-MS

Abrazadera multitubo + taco. Simple

CÓDIGO	ØD(MM)	Ø BROCA	PROFUNDIDAD MÍN. DE TALADRO	PROFUNDIDAD MIN. DEL#ANCLAJE	EXTRACCIÓN#HORMIGÓN NO-FISURADO	EXTRACCIÓN#LADRILLO HUECO	MEDIDA TORNILLO
ABMS10	10	5	30	20	9	5	3,5x35
ABMS12	12	5	30	20	9	5	3,5x35
ABMS14	14	6	35	25	15	8	4x45
ABMS16	16	6	35	25	15	8	4x45
ABMS18	18	8	45	30	16	12	4,5x50
ABMS20	20	8	45	30	16	12	4,5x50
ABMS22	22	8	45	30	16	12	4,5x50
ABMS26	26	10	50	40	30	15	6x60
ABMS28	28	10	50	40	30	15	6,5x60

AB-MD

Abrazadera multitubo + taco. Doble

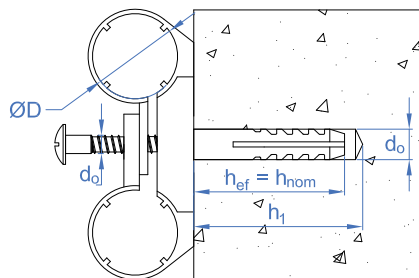

AB-MD

Abrazadera multitubo + taco. Doble

CÓDIGO	ØD(MM)	Ø BROCA	PROFUNDIDAD MÍN. DE TALADRO	PROFUNDIDAD MÍN. DEL ANCLAJE	EXTRACCIÓN HORMIGÓN NO-FISURADO	EXTRACCIÓN LADRILLO HUECO	MEDIDA TORNILLO
ABMD10	10	8	60	30	16	12	4,5x50
ABMD12	12	8	60	30	16	12	4,5x50
ABMD14	14	8	60	30	16	12	4,5x50
ABMD16	16	8	60	30	16	12	4,5x50
ABMD18	18	10	70	40	30	15	6x60
ABMD20	20	10	70	40	30	15	6x60
ABMD22	22	10	70	40	30	15	6x60
ABMD26	26	10	70	40	30	15	6x60
ABMD28	28	10	70	40	30	15	6x60

AB-T

Taco para fijación de tubo INDEXring

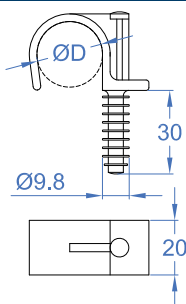

AB-TS

Simple

CÓDIGO	ØD(MM)	ØD(")	CARGA MÁXIMA
ABTS014	14 - 15	-	-
ABTS016	16 - 17	3/8"	-
ABTS018	18 - 19	-	-
ABTS020	20 - 21	1/2"	-
ABTS022	22 - 23	-	-
ABTS025	25 - 26	3/4"	-
ABTS028	28 - 29	-	-
ABTS032	30 - 32	-	-

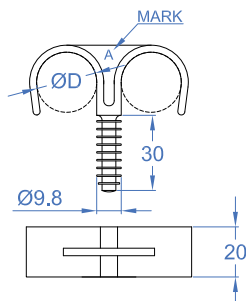

AB-TD

Doble

CÓDIGO	ØD(MM)	ØD(")	CARGA MÁXIMA
ABTD016	15 - 16	3/8"	-
ABTD018	18 - 19	-	-
ABTD020	20 - 21	1/2"	-
ABTD022	22 - 23	-	-
ABTD025	25 - 26	3/4"	-
ABTD028	28 - 29	-	-

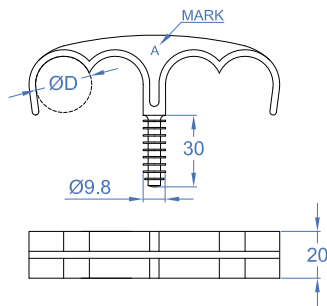

AB-TC

Cuádruple

CÓDIGO	ØD(MM)	ØD(")	CARGA MÁXIMA
ABTC020	20 - 21	1/2"	-
ABTC025	25 - 26	3/4"	-

SU

Sistemas de fijación rápida en viga

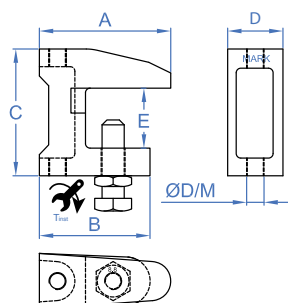

SU-MO

Mordaza para viga

CODIGO	A	B	C	D	E	PAR DE APRIETE	LLAVE DE INSTALACIÓN (SW)	ØD (MM)	MEDIDA TORNILLO
SUMOP09	38	35	37	18	20	10	13	PASANTE Ø9	M8 x 35
SUMOP11	44	41	42	21	20	15	17	PASANTE Ø11	M10 x 40
SUMOP13	58	48	54	24	25	15	17	PASANTE Ø13	M10 x 50
SUMOM06	38	35	37	18	20	10	13	ROSCADO M6	M6 x 35
SUMOM08	38	35	37	18	20	10	13	ROSCADO M8	M8 x 35
SUMOM10	44	41	42	21	20	15	17	ROSCADO M10	M10 x 40
SUMOM12	58	48	54	24	25	15	17	ROSCADO M12	M10 x 50

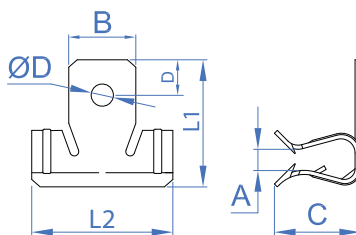

SU-CL

Clip de suspensión

CODIGO	A	B	C	D	L1	L2	ØD(MM)
SUCL02	1,5 - 4	13	14	10	28	28	6.3
SUCL04	4 - 10	19	23	10	34	40	6.3
SUCL10	10 - 15	19	23	10	40	40	6.3
SUCL15	15 - 20	19	23	10	40	40	6.3

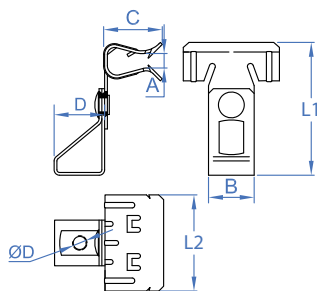

SU-VA

Clip varilla

CODIGO	A	B	C	D	L1	L2	ØD (MM)
SUVA0602	1,5 - 4	19	14	21	50	28	M6
SUVA0604	4 - 10	19	23	21	54	40	M6
SUVA0610	10 - 15	19	23	21	60	40	M6
SUVA0615	15 - 20	19	23	21	60	40	M6
SUVA0804	1,5 - 4	19	14	21	50	28	M8
SUVA0810	4 - 10	19	23	21	54	40	M8
SUVA0815	10 - 15	19	23	21	60	40	M8
SUVA0802	15 - 20	19	23	21	60	40	M8

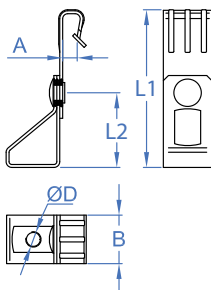

SU-CU

Clip de cuelgue

CODIGO	A	B	L1	L2	ØD (MM)
SUCU0602	1,5 - 5	19	65	30	M6
SUCU0605	5 - 7	19	65	30	M6
SUCU0606	3 - 7	19	80	30	M6
SUCU0607	7 - 10	19	95	30	M6

SU-AB

Clip de viga para abrazadera

CÓDIGO	ESPEJOR MÁX. A FIJAR	ANCHO MAX. DE VIGA	ØD(MM)	H1	H3	MEDIDA TORNILLO
SUAB0603	3 - 7	36,5	M6	30	36,5	M6x9
SUAB0607	7 - 13	36,5	M6	36	36,5	M6x9
SUAB0614	14 - 20	36,5	M6	43	36,5	M6x9

SU-CA

Clip de viga para cable

CÓDIGO	ESPEJOR MÁX. A FIJAR	ØD(MM)	GROSOR
SUCA0602	1 - 4	6-7	0,6
SUCA0604	4 - 7,5	6-7	0,6
SUCA0607	7,5 - 12	6-7	0,6
SUCA0802	1 - 4	8-9	0,6
SUCA0804	4 - 7,5	8-9	0,6
SUCA0807	7,5 - 12	8-9	0,6
SUCA1002	1 - 4	10-11	0,6
SUCA1004	4 - 7,5	10-11	0,6
SUCA1007	7,5 - 12	10-11	0,6
SUCA1202	1 - 4	12-14	0,6
SUCA1204	4 - 7,5	12-14	0,6
SUCA1207	7,5 - 12	12-14	0,6
SUCA1502	1 - 4	15-18	0,6
SUCA1504	4 - 7,5	15-18	0,6
SUCA1507	7,5 - 12	15-18	0,6
SUCA1902	1 - 4	19-24	0,6
SUCA1904	4 - 7,5	19-24	0,6
SUCA1907	7,5 - 12	19-24	0,6
SUCA2502	1 - 4	25-30	0,6
SUCA2504	4 - 7,5	25-30	0,6
SUCA2507	7,5 - 12	25-30	0,6

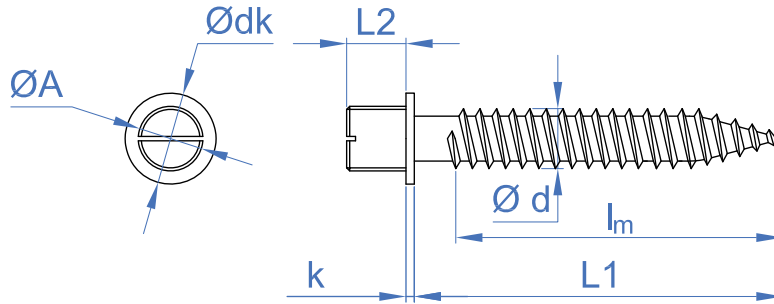

AB-TA

Cincado. Ranurado

CODIGO	METRICA	ØD	L1	L2	K	ØDK	LONGITUD DE ROSCA
ABTA0630	M6	5	30	6	1	8	30
ABTA0640	M6	5	40	6	1	8	40
ABTA0650	M6	5	50	6	1	8	50
ABTA0730	M7	6	22	6	1	9,5	-
ABTA0740	M7	6	32	6	1	9,5	-
ABTA0750	M7	6	42	6	1	9,5	-
ABTA0760	M7	6	52	6	1	9,5	-
ABTA0770	M7	6	62	6	1	9,5	-
ABTA0780	M7	6	72	6	1	9,5	-
ABTA0840	M8	6	40	7,5	1,4	8,5	40
ABTA0860	M8	6	60	7,5	1,4	8,5	60
ABTA0880	M8	6	80	7,5	1,4	8,5	45
ABTA1050	M10	8	50	9	1,7	12	50
ABTA1070	M10	8	70	9	1,7	12	45
ABTA1090	M10	8	90	9	1,7	12	45

AB-TA B

Bicromatado. Ranurado

CODIGO	METRICA	ØD	L1	L2	K	ØDK	LONGITUD DE ROSCA
ABTAB0630	M6	5	30	6	1	8	30
ABTAB0640	M6	5	40	6	1	8	40
ABTAB0650	M6	5	50	6	1	8	50

AB-TA A2

Inoxidable A2. Ranurado

CODIGO	METRICA	ØD	L1	L2	K	ØDK	LONGITUD DE ROSCA
ABTA20630	M6	5	30	7	1,2	7,8	30

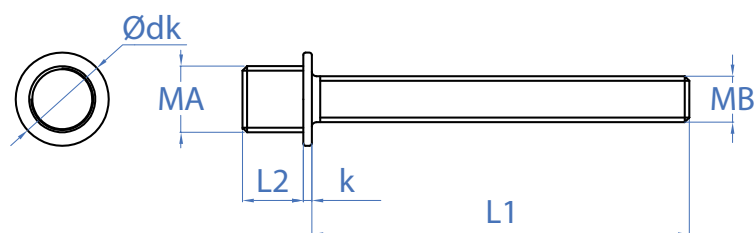

AB-TR

Tornillo doble para abrazaderas

CODIGO	METRICA	L1	L2	K	ØDK
ABTR05030	M7	30	6	1	9
ABTR05040	M7	40	6	1	9
ABTR05050	M7	50	6	1	9
ABTR05060	M7	60	6	1	9
ABTR06040	M7	40	6	1	9
ABTR06050	M7	50	6	1	9
ABTR06060	M7	60	6	1	9

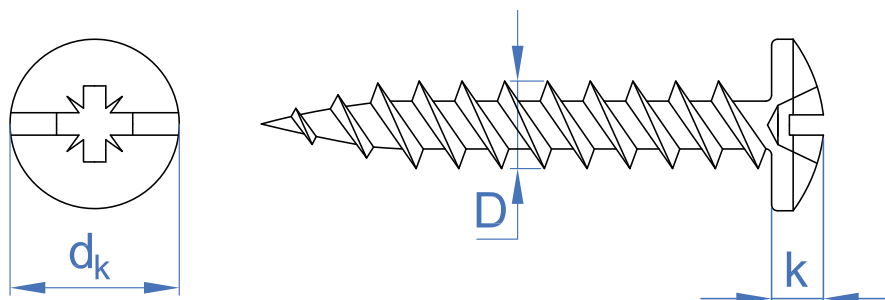

AB-TG

Tirafondo grapa. Huella combi

CODIGO	LONGITUD	LLAVE DE INSTALACION	ØDK	K	ØD(MM)Ø90
ABTG4530	30	PZ2	10	3	4,5
ABTG4535	35	PZ2	10	3	4,5
ABTG4540	40	PZ2	10	3	4,5
ABTG5030	30	PZ3	12	3	5
ABTG5040	40	PZ3	12	3	5

ES-DR

Espárrago de doble rosca

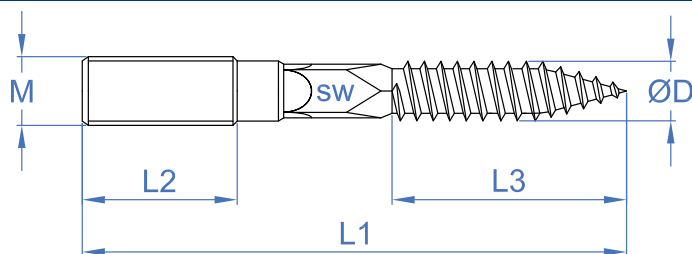

ES-DR

Cincado. Tx

CODIGO	METRICA	LONGITUD	ØD(MM)	LLAVE DE INSTALACIÓN (SW)	L1	L2	L3
ESDR06040	M6	40	6	-	40	12	24
ESDR06050	M6	50	6	-	50	16	28,5
ESDR06060	M6	60	6	-	60	18	34,5
ESDR06070	M6	70	6	-	70	26	34,5
ESDR06080	M6	80	6	-	80	34	34,5
ESDR08050	M8	50	7	-	50	13	29,5
ESDR08060	M8	60	7	-	60	15	37,5
ESDR08070	M8	70	7	-	70	25	37,5
ESDR08080	M8	80	7	6	80	28,5	37,5
ESDR08090	M8	90	7	6	90	28,5	48,5
ESDR08100	M8	100	7	6	100	33,5	48,5
ESDR08110	M8	110	7	6	110	42,5	48,5
ESDR08120	M8	120	7	6	120	50	48,5
ESDR08130	M8	130	7	6	130	50	48,5
ESDR10080	M10	80	8	8	80	18	46,5
ESDR10100	M10	100	9	8	100	24	57
ESDR10110	M10	110	9	8	110	38	57
ESDR10120	M10	120	9	8	120	45	57
ESDR10130	M10	130	9	8	130	50	57
ESDR10140	M10	140	9	8	140	50	57
ESDR10150	M10	150	9	8	150	50	57
ESDR10180	M10	180	9	8	180	50	57
ESDR10200	M10	200	9	8	200	50	57

ES-DA2

Inoxidable A2. Tx

CODIGO	METRICA	LONGITUD	ØD(MM)	LLAVE DE INSTALACIÓN (SW)	L1	L2	L3
ESDA208060	M8	60	7	6	60	20	30
ESDA210060	M10	60	9	8	60	20	30

GAMA DE ELEMENTOS DE SOPORTACIÓN

CÓDIGO	DESCRIPCION	MATERIAL	RECUBRIMIENTO
GPZ201010	Carril 20 x 10 x 1	A	Z
GPZ250808	Carril 25 x 8 x 0,80	A	Z
GPG271812	Carril 27 x 18 x 1,25	A	Z
GPG283018	Carril 28 x 30 x 1,80	A	Z
GPG384020	Carril 38 x 40 x 2,00	A	Z
GPG351312	Carril 35 x 12 x 1,20	A	Z
GPG402015	Carril 40 x 20 x 1,50	A	Z
GPI271812	Carril 27 x 18 x 1,25	A2	Z
GPI283015	Carril 28 x 30 x 1,50	A	Z
GPP271812	Carril 27 x 18 x 1,25	A	Z
GPV251120	Carril 25 x 11 x 2,00	PVC	Z
GPO357510	Guía Omega perforada/lisa cincada	A	Z
GPO351515		A	Z
GLO357510		A	Z
GLO351515		A	Z
SPZ271820	Soporte 27 x 18 x 1,20 x 200	A	Z
SPZ271830	Soporte 27 x 18 x 1,20 x 300		
SPZ384020	Soporte 38 x 40 x 2,00 x 200		
SPZ384025	Soporte 38 x 40 x 2,00 x 250		
SPZ384030	Soporte 38 x 40 x 2,00 x 300		
SPZ384035	Soporte 38 x 40 x 2,00 x 350		
SPZ384040	Soporte 38 x 40 x 2,00 x 400		
SPZ384050	Soporte 38 x 40 x 2,00 x 500		
SPZ384060	Soporte 38 x 40 x 2,00 x 600		
SPV2718	Soporte vertical		
SPH2718	Soporte horizontal	A	Z
SPH3840		A	Z
SPGH2718	Soporte horizontal carriles	A	Z
SPGH3840		A	Z
TG230620	Tope tornillo guía perforada	A	Z
TG230820		A	Z
TG230830		A	Z
TG340830		A	Z
TG41030		A	Z
TUG201006	Tuerca guía perforada	A	Z
TUG201008		A	Z
TUG271808		A	Z
TUG271810		A	Z
TUGRA2706	Tuerca guía con arandela fijación rápida	A	Z
TUGRA2708		A	Z
TUGRA3808		A	Z
TUGRA3810		A	Z
TGR230620	Tope-tornillo guía de fijación rápida	A	Z
TGR230820		A	Z
TGR230830		A	Z
TGR340830		A	Z
TGR341030		A	Z
EMZ45	Escuadras cincadas e inoxidables	A	Z
EMZ90		A	Z
EMZ00		A	Z
EMI45		A2	Z
EMI90		A	Z
EMIO0		A	Z
PGZ2718	Puente guía cincado e inoxidable	A	Z
PGZ2830		A	Z
PGZ3840		A	Z
PGI2718		A2	Z
PGI2830		A	Z
PGI3840	Placa de unión para perfiles	A	Z
PUZ2718		A	Z
PUZ3840	A	Z	
SOTP2718	Tapón plástico para soportación	EPDM	Z
SOTP2830			
SOTP3840			
SOTP4121			
SOTP4141			
SOPG27	Cubierta de goma para soportación	EPDM	Z
SOPG38			
SOPG41			

CÓDIGO	DESCRIPCION	MATERIAL	RECUBRIMIENTO		
GPX412115	Carril 41 x 21 x 1,50	A	Z		
GPX412120	Carril 41 x 21 x 2,00				
GPX412125	Carril 41 x 21 x 2,50				
GPX414115	Carril 41 x 41 x 1,50				
GPX414120	Carril 41 x 41 x 2,00				
GPX414125	Carril 41 x 41 x 2,50				
GPX2M412120	Carril 41 x 21 x 2,00				
GPX2M414120	Carril 41 x 41 x 2,00				
SPX412115	Soporte 41 x 21 x 2,50 x 150			A	Z
SPX412130	Soporte 41 x 21 x 2,50 x 300				
SPX412145	Soporte 41 x 21 x 2,50 x 450				
SPX414115	Soporte 41 x 41 x 2,50 x 150				
SPX414130	Soporte 41 x 41 x 2,50 x 300				
SPX414145	Soporte 41 x 41 x 2,50 x 450				
SPX414160	Soporte 41 x 41 x 2,50 x 600				
SPX414175	Soporte 41 x 41 x 2,50 x 750				
SPX414110	Soporte 41 x 41 x 2,50 x 1000				
SPGH3840	Soporte horizontal	A	Z		
PRX01	Soporte regulable para perfil INDETRUT	A	Z		
SPRXH4121	Soporte base rectangular U INDETRUT	A	Z		
SPRXV4121		A	Z		
SPUX412100	Soporte base U INDETRUT	A	Z		
SPUX412145		A	Z		
ABGX4121	Abrazadera guía perforada INDETRUT	A	Z		
EMPX4121	Empalme para perfiles INDETRUT	A	Z		
RESX300	Refuerzo soportes INDETRUT	A	Z		
RESX550		A	Z		
RTX01	Soporte rotula INDETRUT	A	Z		
EMX9002	Escuadras cincadas INDETRUT	A	Z		
EMX9004					
EMX4502					
EMX1302	Puente guía INDETRUT	A	Z		
PGX4121					
PGX4141					
UNEX412103	Unión escuadra/placa T INDETRUT	A	Z		
UNPX42101					
UNPX42102					
UNPX42103					
UNPX42104					
UNTX412104					
SCRX090	Escuadra reforzada INDETRUT	A	Z		
TUGX08	Tuerca guía perforada	A	Z		
TUGX10	Tuerca guía con muelle INDETRUT	A	Z		
TUGXMU08					
TUGXMU10	Tope-tornillo guía INDETRUT	A	Z		
TGX0840					
TGX0860					
TGX1040					
TGX1060	Tuerca fijación rápida INDETRUT	A	Z		
TURX08					
TURX10					
TURX12	Tuerca INDETRUT con arandela de fijación rápida	A	Z		
TURXA08					
TURXA10					
TGRX0830	Tope guía INDETRUT de fijación rápida	A	Z		
TGRX0860					
TGRX1030					
TGRX1060	Patín de expansion	A	Z		
PAEXM08					
PAEXM10	Tapón plástico para soportación	EPDM	Z		
SOTP4121					
SOTP4141					
SOPG41	Cubierta de goma para soportación	EPDM	Z		

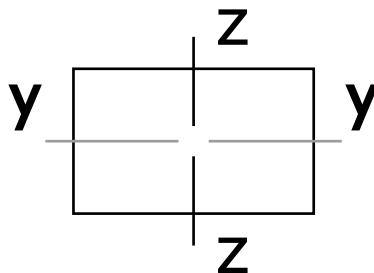
ASPECTOS GEOMÉTRICOS

CÓDIGO	SECCIÓN	PESO	ÁREA	MOMENTO INERCIA (I _y)	MOMENTO INERCIA (I _z)	MÓDULO RESISTENTE (W _y)	MÓDULO RESISTENTE (W _z)
	[mm x mm]	[Kg/m]	[cm ²]	[cm ⁴]	[cm ⁴]	[cm ³]	[cm ³]
GPZ201010	20 x 10	0.31	0.44	0.06	0.25	0.10	0.25
GPZ250808	25 x 8	0.26	0.35	0.03	0.30	0.06	0.24
GPG271812	27 x 18	0.66	0.84	0.37	0.97	0.34	0.71
GPG283018	28 x 30	1.25	1.60	1.79	2.10	1.03	1.50
GPG384020	38 x 40	2.00	2.55	5.39	6.18	2.39	3.25
GPG402015	40 x 20	0.94	1.30	0.71	3.10	0.57	1.55
GPP271812	27 x 18	0.66	0.84	0.37	0.97	0.34	0.71
GPI271812	27 x 18	0.66	0.79	0.36	0.90	0.33	0.67
GPI283015	28 x 30	1.25	1.37	1.54	1.82	0.89	1.30
GPX412115	41 x 21	1.21	1.41	0.89	3.58	0.70	1.75
GPX412120	41 x 21	1.55	1.99	0.95	4.44	0.75	2.17
GPX412125	41 x 21	1.71	2.28	1.32	5.54	1.03	2.70
GPX414115	41 X 41	1.65	2.42	4.88	5.99	2.05	2.92
GPX414120	41 x 41	2.09	2.65	5.84	7.62	2.46	3.72
GPX414125	41 x 41	2.53	3.28	7.08	9.25	2.98	4.51
GPX2M412120	41 x 21	1.55	1.99	0.95	4.44	0.75	2.17
GPX2M414120	41 x 41	2.09	2.65	5.84	7.62	2.46	3.72
SPZ271820	27 x 18	1,2	0.84	0.37	0.97	0.34	0.71
SPZ271830	27 x 18	1,2	0.84	0.37	0.97	0.34	0.71
SPZ384020	38 x 40	2,4	2.55	5.39	6.18	2.39	3.25
SPZ384025	38 x 40	2,4	2.55	5.39	6.18	2.39	3.25
SPZ384030	38 x 40	2,4	2.55	5.39	6.18	2.39	3.25
SPZ384035	38 x 40	2,4	2.55	5.39	6.18	2.39	3.25
SPZ384040	38 x 40	2,4	2.55	5.39	6.18	2.39	3.25
SPZ384050	38 x 40	2,4	2.55	5.39	6.18	2.39	3.25
SPZ384060	38 x 40	2,4	2.55	5.39	6.18	2.39	3.25
SPX412115	41 x 21	1,88	2.28	1.32	5.54	1.03	2.70
SPX412130	41 x 21	1,88	2.28	1.32	5.54	1.03	2.70
SPX412145	41 x 21	1,88	2.28	1.32	5.54	1.03	2.70
SPX414115	41 x 41	2,7	3.28	7.08	9.25	2.98	4.51
SPX414130	41 x 41	2,7	3.28	7.08	9.25	2.98	4.51
SPX414145	41 x 41	2,7	3.28	7.08	9.25	2.98	4.51
SPX414160	41 x 41	2,7	3.28	7.08	9.25	2.98	4.51
SPX414175	41 x 41	2,7	3.28	7.08	9.25	2.98	4.51
SPX414110	41 x 41	2,7	3.28	7.08	9.25	2.98	4.51

RED COMERCIAL ESPAÑA

ÁLAVA

Mikel Paredes
mparedes@indexfix.com
Tfno. 679 559 519

ALBACETE

Antonio Álvarez
a.alvarezmegias@gmail.com
Tfno. 678 537 861

ALICANTE

Valentín Ramos
representacionesvalentin@gmail.com
Tfno. 606 305 980
Maxi Flores
Tfno. 647 447 793

ALMERÍA

José María Pérez Capel
representaciones@perezcapel.com
Tfno. 683 353 495

ANDORRA

Pere Soro
peresoro@gmail.com
Tfno. 609 363 693

ASTURIAS

Asier Saenz
asaenz@indexfix.com
Tfno. 941 272 131

ÁVILA

Vicente Beltrán
vicentebeltran@telefonica.net
Tfno. 609 616 926

BADAJOS

Adrián Apellaniz
aapellaniz@indexfix.com
Tfno. 941 272 131

BALEARES

Antonio Forteza
repforpa@gmail.com
Tfno. 636 973 665
Agustín Forteza
repforteza@gmail.com
Tfno. 660 725 880

BARCELONA - TARRAGONA

Roger Rosell
rrosell@indexfix.com
Tfno. 618 361 743

BURGOS

Óscar Aliende
oaliende@indexfix.com
Tfno. 629 777 206

CÁCERES

Adrián Apellaniz
aapellaniz@indexfix.com
Tfno. 941 272 131

CÁDIZ

José Antonio Prieto
prietocadiz@yahoo.es
Tfno. 667 552 000

CANARIAS

Alfredo Carrancio Sosa
accarrancio@indexfix.com
Tfno. 600 462 930

CANTABRIA

Mikel Paredes
mparedes@indexfix.com
Tfno. 679 559 519

CASTELLÓN

Francisco Blasco
representacionesblasco@gmail.com
Tfno. 639 672 267

CEUTA

Luis Fernando Reguera
luis@representacionesreguera.com
Tfno. 696 416 886

CIUDAD REAL

Vicente Beltrán
vicentebeltran@telefonica.net
Tfno. 609 616 926

CÓRDOBA

Adrián Apellaniz
aapellaniz@indexfix.com
Tfno. 941 272 131

CUENCA

Vicente Beltrán
vicentebeltran@telefonica.net
Tfno. 609 616 926

GERONA

David Mejías
lunadarepres@gmail.com
Tfno. 622 453 509

GRANADA

Ismael Marco
ismaelmarcorios@gmail.com
Tfno. 670 242 337
Armando Ríos
Tfno. 670 453 269

GUADALAJARA

Vicente Beltrán
vicentebeltran@telefonica.net
Tfno. 609 616 926

GUIPÚZCOA

Koldo Balda González
baldas@yahoo.es
Tfno. 629 476 660

HUELVA

Jose M^o Castillo
jmcastilloq@yahoo.es
Tfno. 667 769 427

HUESCA

Fernando Gonzalo
fgonzalo@fgms.es
Tfno. 609 879 313

JAEN

Ismael Marco
ismaelmarcorios@gmail.com
Tfno. 670 242 337
Armando Ríos
Tfno. 670 453 269

LA CORUÑA

Carlos Seoane
cseoane@indexfix.com
Tfno. 618 614 872

LA RIOJA

Álvaro Bartolomé
abartolome@indexfix.com
Tfno. 608 278 355

LEÓN

Francisco Viñuela
pacovinelaleon@hotmail.com
Tfno. 670 597 272

LLEIDA

Pere Soro
peresoro@gmail.com
Tfno. 609 363 693

LUGO

Carlos Seoane
cseoane@indexfix.com
Tfno. 618 614 872

MADRID

Sergio de Miguel
sdemiguel@indexfix.com
Tfno. 608 566 769
Álvar Martín
amartin@indexfix.com
Tfno. 630 175 362
Cristina Conde
cconde@indexfix.com
Tfno. 638 547 099
Francisco Hernandez
fhernandez@indexfix.com
Tfno. 747 449 280

MÁLAGA

Antonio J. Martín
repmartin@hotmail.com
Tfno. 610 701 604
Enrique Martín
Tfno. 667 574 316

MELILLA

Enrique Martín
repmartin@hotmail.com
Tfno. 667 574 316

MURCIA

Facundo Cuenca e Hijos, S.L.
info@facundocuenca.com
Tfno. 968 898 167

NAVARRA

Eduardo Pellejero
epellejero@telefonica.net
Tfno. 658 842 592

ORENSE

Carlos Seoane
cseoane@indexfix.com
Tfno. 618 614 872

PALENCIA

Óscar Aliende
oaliende@indexfix.com
Tfno. 629 777 206

PONTEVEDRA

Carlos Seoane
cseoane@indexfix.com
Tfno. 618 614 872

SALAMANCA

Javier Vecino
javiervecino@hotmail.com
Tfno. 609 811 878

SEGOVIA

Vicente Beltrán
vicentebeltran@telefonica.net
Tfno. 609 616 926

SEVILLA

José Antonio Bonilla
jabonilla@jabonilla.es
Tfno. 607 433 102

SORIA

Comercial Arrieta C.B.
gorka_arrieta@yahoo.es
Tfno. 619 416 914

TERUEL

Fernando Gonzalo
fgonzalo@fgms.es
Tfno. 609 879 313

TOLEDO

Vicente Beltrán
vicentebeltran@telefonica.net
Tfno. 609 616 926

VALENCIA

Francisco Blasco
representacionesblasco@gmail.com
Tfno. 639 672 267

VALLADOLID

Javier Vecino
javiervecino@hotmail.com
Tfno. 609 811 878

VIZCAYA

Mikel Paredes
mparedes@indexfix.com
Tfno. 679 559 519

ZAMORA

Francisco Viñuela
pacovinelaleon@hotmail.com
Tfno. 670 597 272

ZARAGOZA

Fernando Gonzalo
fgonzalo@fgms.es
Tfno. 609 879 313

PRESENCIA INTERNACIONAL



FRANCIA - Aquitania, Languedoc-Rosellón, Lemosín, Mediodía-Pirineos
Thierry Nouvel - T-Nouvel
t-nouvel@indexfix.com
+ 33 (0) 608.578.114

FRANCIA - Auvernia, Borgoña, Ródano-Alpes
Sales-up
Martin Broizart
m.broizat@directfab.fr
+ 33 (0) 665.493.382

FRANCIA - Bretaña, Países del Loira
Rodolphe Hirn
rhirn@indexfix.com
+ 33 (0) 676.282.469

FRANCIA - Isla de Francia
Geoffroy Ehlinger
gehlinger@indexfix.com
+ 33 (0) 675.474.552

FRANCIA - Córcega
Franck Platerier
franck.platerier@sdpro.fr
+ 33 (0) 7 85 42 10 28

FRANCIA - DOM TOM
Jacques Vergé
jverge@indexfix.com
+ 33 (0) 468.691.968

FRANCIA - PACA
Jean Vivien
contact.sdpro@free.fr
+33 (0) 607.853.297

FRANCIA - ESTE
Frederic Koenig
fred.koenig@outlook.fr
+ 33 (0) 633454230

FRANCIA - NORTE Y NORMANDÍA
Eric Ducrocq
educrocq@ixsaw.com
+ 33 (0) 6 85 52 13 05

ALEMANIA
Dieter Fernandez
dfernandez@indexfix.com
+ 49 (0) 171 27 64 898

ITALIA (Campania)
Sansone Rappresentanza
sansonerappresentanza@gmail.com
+39 3925804863

RUMANÍA
Dacian Lupu
dlupu@indexfix.com
+ 40 775 197 970

SENEGAL / COSTA DE MARFIL
BENIN / CAMERÚN / GABÓN / CONGO
Jacques Vergé
jverge@indexfix.com
+ 33 (0) 468.691.968

MARRUECOS
NOUMAREP
Brahim Nouçair
noucair@indexfix.com
+ 212 (0) 122.230.21.27

PORTUGAL
Marco Sousa
marcosousa@indexfix.com
+ 351 913.908.536

GRECIA
M.I. SASSON & CO O.E.
msaso@indexfix.com
+ 30 6932 406 106

ALEMANIA
ARABIA SAUDITA
ARGELIA
AUSTRALIA
AUSTRIA
BANGLADESH
BÉLGICA
BENÍN
BOLIVIA
BOSNIA
BULGARIA
CAMERÚN
CHIPRE
COLOMBIA
CONGO
COSTA DE MARFIL
CROACIA
CUBA
DINAMARCA
EGIPTO
EMIRATOS ÁRABES
ESCOCIA
ESLOVENIA
ESTADOS UNIDOS
ESTONIA
FINLANDIA
FRANCIA
GABÓN
GRECIA
GUAYANA FRANCESA
GUINEA ECUATORIAL
HOLANDA
HONDURAS
HUNGRÍA
INDIA
INDONESIA
INGLATERRA
IRÁN
IRLANDA
IRLANDA DEL NORTE
ISLA GUADALUPE
ISLANDIA
ISRAEL
ITALIA
KOSOVO
KUWAIT
LETONIA
LÍBANO
LITUANIA
LUXEMBURGO
MACEDONIA
MADAGASCAR
MALTA
MARRUECOS
MARTINICA
MAURICIO
MÉXICO
MONTENEGRO
NORUEGA
NUEVA CALEDONIA
OMÁN
PAKISTÁN
PANAMÁ
PERÚ
POLINESIA FRANCESA
POLONIA
PORTUGAL
QATAR
REPUBLICA CHECA
REPUBLICA DOMINICANA
REPUBLICA ESLOVACA
REUNIÓN
RUMANIA
RUSIA
SENEGAL
SERBIA
SINGAPUR
SUECIA
SUIZA
TAILANDIA
TÚNEZ
TURQUÍA
UCRANIA
URUGUAY

A photograph of a brown cardboard box in a warehouse. The box is the central focus, with the 'INDEX' logo and slogan 'A PERFECT FIXING' printed on it in blue. The background is a blurred warehouse interior with a worker in a blue uniform on the left and overhead lights.

INDEX[®]
A PERFECT FIXING

CONDICIONES DE VENTA ESPAÑA

PORTES

Los portes serán pagados a partir de 250€ netos para los envíos a la península y Baleares. En este caso, nos reservamos el derecho a remitir las mercancías por nuestra habitual agencia de transportes.

En el caso de que los portes sean debidos y salvo indicación expresa por parte del cliente, las mercancías las enviaremos por nuestra habitual agencia de transportes.

Rogamos procedan a verificar el estado de la mercancía a su recepción y formulen ante el transportista las reservas que en su caso procedan, comunicándonos las posibles objeciones de inmediato.

La recepción de la mercancía, supone la aceptación de las condiciones generales de venta de INDEX A Perfect Fixing.

El importe mínimo de pedido es de 100€. Por cuestiones derivadas de costos y, en el caso de aceptarse un pedido de importe inferior, se cargarán 10€ en concepto de gastos de gestión.

CONDICIONES DE PAGO

Forma de pago: Giro bancario domiciliado a 60 días máximo.

Si las letras no están domiciliadas, INDEX A Perfect Fixing, en ningún caso se hará cargo de los posibles gastos de devolución.

Los documentos de pago, deberán ser remitidos en un plazo máximo de 30 días posteriores a la fecha de la factura.

Los documentos de pago que no respeten los vencimientos reflejados en nuestra factura, ocasionarán un cargo por aplazamiento del 1% mensual.

Nuestro sistema informático retendrá automáticamente los pedidos si se produjese algún impago o demora en la recepción de documentos de pago.

PLAZO DE ENTREGA

Salvo acuerdo expreso por nuestra Central, los plazos de entrega indicados por nuestros representantes son a título orientativo.

El retraso de los plazos de entrega o fechas previstas no dará lugar a penalización.

AGOSTO Y DICIEMBRE

Los vencimientos que se atiendan en estos meses, no tendrán cargos ni abonos. Si el vencimiento se fracciona al 50% entre el mes anterior y posterior, no se aplicarán cargos ni abonos.

Si el vencimiento se adelanta al mes anterior, se abonará en factura un 1% de descuento en concepto de pago adelantado.

Si el vencimiento se aplaza al mes siguiente, se cargará en factura un 1% en concepto de gastos financiero.

DEVOLUCIÓN DE MATERIAL

No se admitirán devoluciones de material transcurridos 15 días desde la fecha de entrega.

Si la devolución se produce por motivos no imputables a INDEX A Perfect Fixing el cliente la enviará a portes pagados. Adicionalmente se le cargará el coste que se origine en concepto de reempaquetado, así como los del transporte del envío inicial. En total el recargo supondrá un 20% aproximado del valor de la mercancía.

El importe de la mercancía devuelta o abono, será descontado de la factura de origen y se le notificará al cliente.

No se admitirán devoluciones de material a portes debidos, si no vienen por nuestras agencias habituales de transporte.

Para cualquier cuestión derivada de la venta efectuada por INDEX A Perfect Fixing (Técnicas Expansivas, S.L.), serán competentes los Juzgados y Tribunales de la ciudad de Logroño. Los precios de esta tarifa, no incluyen el IVA. INDEX A Perfect Fixing se reserva el derecho a cambiar precios, envasados o artículos en stock sin previo aviso.

INDEX A Perfect Fixing, a razón de sus necesidades de producción, se reserva el derecho a modificar sin previo aviso el diseño, las características o prestaciones de sus productos. Las imágenes de este catálogo, son ilustraciones informativas sin ningún valor contractual, pudiendo no coincidir con el modelo original.

Ref	pag	Ref	pag	Ref	pag	Ref	pag	Ref	pag		
6921108020	226	AACGA10	71	ABAI519042	255	ABDP125	257	ABE186312	155	ABEBO10	332
6921108050	226	AACGA12	71	ABAI519054	255	ABDP160	257	ABE186313	155	ABEBO13	332
6921108070	226	AACTO06	71	ABAI519060	255	ABDP200	257	ABE186314	155	ABEI4213	154
9758ZM05	326	AACTO08	71	ABAI519064	255	ABDP250	257	ABE186319	155	ABEI4216	154
9758ZM06	326	AACTO10	71	ABAI519067	255	ABDZ6012	265	ABE186325	155	ABEI4219	154
9758ZM08	326	AACTO12	71	ABAI519076	255	ABDZ6015	265	ABE186332	155	ABEI4813	154
9758ZM10	326	AACTO16	71	ABAI519080	255	ABDZ6018	265	ABE186338	155	ABEI4816	154
9758ZM12	326	AB61012	266	ABAI519114	255	ABDZ6022	265	ABE186350	155	ABEI4819	154
9758ZM14	326	AB61015	266	ABAI530027	255	ABDZ6028	265	ABE186363	155	ABEI4825	154
9758ZM16	326	AB61016	266	ABAI530034	255	ABDZ70810	267	ABE186375	155	ABEI4832	154
9758ZM18	326	AB61018	266	ABAI530042	255	ABDZ71012	267	ABE186380	155	ABEI5519	154
9758ZM20	326	AB61022	266	ABAI530049	255	ABDZ71214	267	ABE186390	155	ABEI5522	154
9758ZM22	326	AB61026	266	ABAI530054	255	ABDZ71416	267	ABE255522	155	ABEI5525	154
9758ZM24	326	AB61028	266	ABAI530060	255	ABDZ71618	267	ABE255525	155	ABEI6319	154
9758ZM27	326	AB61032	266	ABAI530076	255	ABDZ71820	267	ABE256310	155	ABEI6325	154
9758ZM30	326	AB61035	266	ABAI530089	255	ABDZ72022	267	ABE256311	155	ABERM06006	332
9758ZM33	326	AB61042	266	ABAI530108	255	ABDZ72224	267	ABE256312	155	ABERM08010	332
9758ZM36	326	AB61048	266	ABAI530114	255	ABDZ72628	267	ABE256313	155	ABERM08015	332
975A2M04	326	AB61054	266	ABAI540049	255	ABE144219	155	ABE256314	155	ABFC09	332
975A2M05	326	AB61060	266	ABAI540060	255	ABE144225	155	ABE256325	155	ABFC14	332
975A2M06	326	AB71DZ0810	268	ABAI540089	255	ABE144816	155	ABE256332	155	ABFC19	332
975A2M08	326	AB71DZ1012	268	ABAI540114	255	ABE144819	155	ABE256338	155	ABFP25	331
975A2M10	326	AB71DZ1214	268	ABAI540133	255	ABE144819CP	155	ABE256350	155	ABFP32	331
975A2M12	326	AB71DZ1416	268	ABAI540140	255	ABE144825	155	ABE256363	155	ABGA018	256
975A2M14	326	AB71DZ1618	268	ABAI540159	255	ABE144832	155	ABE256380	155	ABGA022	256
975A2M16	326	AB71DZ1820	268	ABAI540168	255	ABE144838	155	ABE256390	155	ABGA028	256
975A2M18	326	AB71DZ2022	268	ABAI540219	255	ABE145522	155	ABE3509	154	ABGA035	256
975A2M20	326	AB71DZ2224	268	ABBU1315	274	ABE145532	155	ABE3513	154	ABGA040	256
975A2M22	326	AB71DZ2628	268	ABBU1618	274	ABE164219	155	ABE3516	154	ABGA048	256
975A2M24	326	AB71Z010	268	ABBU1921	274	ABE164816	155	ABE3519	154	ABGA054	256
975A2M27	326	AB71Z012	268	ABCH00034	278	ABE164819	155	ABE4213	154	ABGA060	256
975A2M30	326	AB71Z014	268	ABCH01000	278	ABE164819CP	155	ABE4216	154	ABGA075	256
975A2M33	326	AB71Z016	268	ABCH01012	278	ABE164825	155	ABE4219	154	ABGA090	256
975A2M36	326	AB71Z018	268	ABCH01014	278	ABE164832	155	ABE4225	154	ABGA100	256
975ZM04	326	AB71Z020	268	ABCH02000	278	ABE164838	155	ABE4232	154	ABGA110	256
975ZM05	326	AB71Z022	268	ABCH02012	278	ABE165519	155	ABE4238	154	ABGA115	256
975ZM06	326	AB71Z024	268	ABCH03000	278	ABE165522	155	ABE4813	154	ABGA140	256
975ZM08	326	AB71Z026	268	ABCH04000	278	ABE165522CP	155	ABE4816	154	ABGA160	256
975ZM10	326	AB71Z028	268	ABCH05000	278	ABE165525	155	ABE4819	154	ABGD012	275
975ZM12	326	AB71Z032	268	ABCH06000	278	ABE165532	155	ABE4825	154	ABGD015	275
975ZM14	326	AB71Z034	268	ABCH08000	278	ABE165538	155	ABE4832	154	ABGD018	275
975ZM16	326	AB71Z036	268	ABCH10000	278	ABE165550	155	ABE4838	154	ABGD022	275
975ZM18	326	AB71Z038	268	ABCH12000	278	ABE165563	155	ABE5519	154	ABGD028	275
975ZM20	326	AB71Z040	268	ABCH14000	278	ABE165575	155	ABE5522	154	ABGM012	274
975ZM22	326	AB71Z050	268	ABCH16000	278	ABE166310	155	ABE5525	154	ABGM015	274
975ZM24	326	ABA4832	169	ABCIK125	279	ABE166311	155	ABE5532	154	ABCM018	274
975ZM27	326	ABA4838	169	ABCIK130	279	ABE166312	155	ABE5538	154	ABCM022	274
975ZM2M06	327	ABA4845	169	ABCR010	273	ABE166313	155	ABE5550	154	ABCM028	274
975ZM30	326	ABA4850	169	ABCR012	273	ABE166314	155	ABE5563	154	ABCM035	274
975ZM33	326	ABA5538	169	ABD6012	265	ABE166319	155	ABE5575	154	ABCS010	275
975ZM36	326	ABA5545	169	ABD6015	265	ABE166325	155	ABE6310	154	ABCS012	275
AACAR06	71	ABA5555	169	ABD6018	265	ABE166325CP	155	ABE6311	154	ABCS015	275
AACAR08	71	ABA5565	169	ABD6022	265	ABE166332	155	ABE6312	154	ABCS018	275
AACAR10	71	ABA6360	169	ABD6028	265	ABE166338	155	ABE6313	154	ABCS022	275
AACAR12	71	ABA6370	169	ABDE075	257	ABE166350	155	ABE6314	154	ABCS028	275
AACCA06	71	ABA6385	169	ABDE090	257	ABE166363	155	ABE6315	154	ABCS035	275
AACCA08	71	ABAI513010	255	ABDE110	257	ABE166375	155	ABE6316	154	ABCS042	275
AACCA10	71	ABAI513012	255	ABDE125	257	ABE166380	155	ABE6318	154	ABCS054	275
AACCA12	71	ABAI513015	255	ABDE160	257	ABE166390	155	ABE6319	154	ABCUG15	291
AACCA16	71	ABAI513018	255	ABDE200	257	ABE184819	155	ABE6320	154	ABCUG18	291
AACCI06	71	ABAI513022	255	ABDE250	257	ABE184825	155	ABE6322	154	ABCUG20	291
AACCI08	71	ABAI513028	255	ABDE315	257	ABE184838	155	ABE6324	154	ABCUG22	291
AACCI10	71	ABAI519010	255	ABDI0012	266	ABE185522	155	ABE6325	154	ABCUG25	291
AACCI12	71	ABAI519012	255	ABDI0015	266	ABE185525	155	ABE6332	154	ABCUG28	291
AACES06	71	ABAI519015	255	ABDI0018	266	ABE185532	155	ABE6338	154	ABCUG32	291
AACES08	71	ABAI519017	255	ABDI0022	266	ABE185538	155	ABE6350	154	ABCUG40	291
AACES10	71	ABAI519018	255	ABDI0028	266	ABE185550	155	ABE6363	154	ABCUG50	291
AACES12	71	ABAI519022	255	ABDP075	257	ABE185563	155	ABE6375	154	ABGX4121	308
AACGA06	71	ABAI519028	255	ABDP090	257	ABE186310	155	ABE6380	154	ABIA015	249
AACGA08	71	ABAI519035	255	ABDP110	257	ABE186311	155	ABE6390	154	ABIA018	249

Ref	pag	Ref	pag	Ref	pag	Ref	pag	Ref	pag
ABIA022	249	ABM6018	264	ABMZ6035	264	ABPE140	278	ABR3532	164
ABIA028	249	ABM6020	264	ABMZ6037	264	ABPE160	278	ABR3913	164
ABIA035	249	ABM6022	264	ABMZ6040	264	ABPE220	278	ABR3916	164
ABIA042	249	ABM6025	264	ABMZ6042	264	ABPI006	269	ABR3919	164
ABIA048	249	ABM6026	264	ABMZ6047	264	ABPI008	269	ABR3925	164
ABIA054	249	ABM6028	264	ABMZ6050	264	ABPI010	269	ABR3932	164
ABIA060	249	ABM6032	264	ABMZ6054	264	ABPI012	269	ABR4213	164
ABIA075	249	ABM6035	264	ABMZ6060	264	ABPI014	269	ABR4213BLE	165
ABIA090	249	ABM6037	264	ABMZ6063	264	ABPI016	269	ABR4216	164
ABIA100	249	ABM6040	264	ABMZ7008	267	ABPI018	269	ABR4216BLE	165
ABIA110	249	ABM6042	264	ABMZ7010	267	ABPI020	269	ABR4219	164
ABIA115	249	ABM6047	264	ABMZ7012	267	ABPI022	269	ABR4219BLE	165
ABIA125	249	ABM6050	264	ABMZ7014	267	ABPI025	269	ABR4222	164
ABICP060	254	ABM6054	264	ABMZ7016	267	ABPI026	269	ABR4225	164
ABICP075	254	ABM6060	264	ABMZ7018	267	ABPI028	269	ABR4232	164
ABICP090	254	ABM6063	264	ABMZ7020	267	ABPI032	269	ABR4238	164
ABICP110	254	ABM6A2012	265	ABMZ7022	267	ABPI040	269	ABR4250	164
ABICP140	254	ABM6A2015	265	ABMZ7024	267	ABPI042	269	ABR4810	164
ABICP160	254	ABM6A2018	265	ABMZ7025	267	ABPI047	269	ABR4811	164
ABICP220	254	ABM6A2020	265	ABMZ7026	267	ABPI050	269	ABR4812	164
ABICP270	254	ABM6A2022	265	ABMZ7028	267	ABPI063	269	ABR4813	164
ABICP315	254	ABM6A2028	265	ABMZ7032	267	ABPID016	150	ABR4816	164
ABID012	290	ABM8050	256	ABMZ7034	267	ABPID020	150	ABR4819	164
ABID014	290	ABM8063	256	ABMZ7036	267	ABPID025	150	ABR4822	164
ABID016	290	ABM8075	256	ABMZ7038	267	ABPID032	150	ABR4825	164
ABID020	290	ABM8090	256	ABMZ7040	267	ABPMT720	330	ABR4825BLE	165
ABID028	290	ABM8110	256	ABMZ7050	267	ABPMT730	330	ABR4832	164
ABIN012	290	ABM8125	256	ABMZ7063	267	ABPMT740	330	ABR4838	164
ABIN014	290	ABM8160	256	ABP3509	167	ABPRG15	292	ABR4845	164
ABIN016	290	ABM8200	256	ABP3511	167	ABPRG20	292	ABR4850	164
ABIN020	290	ABM8250	256	ABP3513	167	ABPRG25	292	ABR4860	164
ABIN025	290	ABM8315	256	ABP3516	167	ABPRG32	292	ABR4880	164
ABIN028	290	ABMD10	292	ABP3519	167	ABPRG40	292	ABR4890	164
ABIN032	290	ABMD12	292	ABP3522	167	ABPRG50	292	ABR5519	164
ABIN035	290	ABMD14	292	ABP3525	167	ABPT3513	168	ABR5522	164
ABIP015	270	ABMD16	292	ABP3913	167	ABPT3516	168	ABR5525	164
ABIP018	270	ABMD18	292	ABP3916	167	ABPT3519	168	ABR5532	164
ABIP022	270	ABMD20	292	ABP3919	167	ABPT3913	168	ABR5538	164
ABIP026	270	ABMD22	292	ABP3922	167	ABPT3916	168	ABR5545	164
ABIP028	270	ABMD26	292	ABP3925	167	ABPT4213	168	ABR5560	164
ABIP035	270	ABMD28	292	ABP3932	167	ABPT4216	168	ABR5573	164
ABIP042	270	ABMS10	292	ABP3938	167	ABPT4219	168	ABRA015	248
ABIP048	270	ABMS12	292	ABP4213	167	ABPT4225	168	ABRA018	248
ABIP054	270	ABMS14	292	ABP4216	167	ABPT4232	168	ABRA022	248
ABIP060	270	ABMS16	292	ABP4219	167	ABPT4819	168	ABRA028	248
ABIP067	270	ABMS18	292	ABP4222	167	ABPT4825	168	ABRA035	248
ABIP075	270	ABMS20	292	ABP4225	167	ABPT4832	168	ABRA042	248
ABIP090	270	ABMS22	292	ABP4232	167	ABPT4838	168	ABRA048	248
ABIR015	249	ABMS26	292	ABP4238	167	ABPT4850	168	ABRA054	248
ABIR018	249	ABMS28	292	ABP4813	167	ABPU016	269	ABRA060	248
ABIR022	249	ABMUG15	291	ABP4816	167	ABPU018	269	ABRA075	248
ABIR028	249	ABMUG18	291	ABP4819	167	ABPU020	269	ABRA090	248
ABIR035	249	ABMUG22	291	ABP4825	167	ABPU022	269	ABRA100	248
ABIR040	249	ABMUG26	291	ABP4832	167	ABPU025	269	ABRA110	248
ABIR048	249	ABMUG32	291	ABP4838	167	ABPU028	269	ABRA115	248
ABIR054	249	ABMUG40	291	ABP4850	167	ABPU032	269	ABRA125	248
ABIR060	249	ABMUG48	291	ABP5519	167	ABPU037	269	ABRA23509	165
ABITD015	273	ABMZ6008	264	ABP5525	167	ABPU040	269	ABRA23513	165
ABITD018	273	ABMZ6010	264	ABP5532	167	ABPU050	269	ABRA23519	165
ABITD022	273	ABMZ6012	264	ABP5538	167	ABPU063	269	ABRA24213	165
ABITS015	273	ABMZ6014	264	ABP5550	167	ABR3509	164	ABRA24216	165
ABITS018	273	ABMZ6015	264	ABPE028	278	ABR3509BLE	165	ABRA24219	165
ABITS022	273	ABMZ6016	264	ABPE035	278	ABR3511	164	ABRA24225	165
ABITS028	273	ABMZ6018	264	ABPE040	278	ABR3513	164	ABRA24816	165
ABM6008	264	ABMZ6020	264	ABPE048	278	ABR3513BLE	165	ABRA24819	165
ABM6010	264	ABMZ6022	264	ABPE060	278	ABR3516	164	ABRA24825	165
ABM6012	264	ABMZ6025	264	ABPE075	278	ABR3516BLE	165	ABRA24832	165
ABM6014	264	ABMZ6026	264	ABPE090	278	ABR3519	164	ABRA24838	165
ABM6015	264	ABMZ6028	264	ABPE100	278	ABR3522	164	ABRA24850	165
ABM6016	264	ABMZ6032	264	ABPE115	278	ABR3525	164	ABRC3509	166

Ref	pag	Ref	pag	Ref	pag	Ref	pag	Ref	pag		
ABREA2035	251	ABRIA2022	253	ABRT4890	166	ABTG4540	330	ACHTI0L	61	AFPGI44828	199
ABREA2040	251	ABRIA2028	253	ABRT5519	166	ABTG5030	330	ACHTI1C	61	AFPGI44835	199
ABREA2048	251	ABRIA2035	253	ABRT5525	166	ABTG5040	330	ACHTI1L	61	AFRDI44819	198
ABREA2054	251	ABRIA2040	253	ABRT5532	166	ABTO06015	270	ACHTI2C	61	AFRDI44828	198
ABREA2060	251	ABRIA2048	253	ABRT5538	166	ABTR05030	330	ACHTI2L	61	AFRDI44835	198
ABREA2075	251	ABRIA2054	253	ABRT5560	166	ABTR05040	330	ACHTI4C	61	AFRTI44819	197
ABREA2090	251	ABRIA2060	253	ABRT5573	166	ABTR05050	330	ACHTI4L	61	AFRTI44828	197
ABREA2110	251	ABRIA2075	253	ABSA050100	259	ABTR05060	330	ACHTI6C	61	AFRTI44835	197
ABREA2115	251	ABRIA2090	253	ABSA050125	259	ABTR06040	330	ACHTI6L	61	AFVEI44819	198
ABREA2125	251	ABRIA2110	253	ABSA050200	259	ABTR06050	330	ACHT20C	61	AFVEI44828	198
ABREA2140	251	ABRIA2115	253	ABSA050300	259	ABTR06060	330	ACHT25C	61	AFVEI44835	198
ABREA2160	251	ABRIA2125	253	ABSA050400	259	ABTS014	293	ACHT8808C	62	AFZNI44819	197
ABREA2200	251	ABRIA2140	253	ABSA050500	259	ABTS016	293	ACHT8808E	62	AFZNI44828	197
ABREA4018	251	ABRIA2160	253	ABSA050600	259	ABTS018	293	ACHT8808L	62	AFZNI44835	197
ABREA4022	251	ABRIA4018	253	ABSA100100	259	ABTS020	293	ACHT8810C	62	AGP023025	259
ABREA4028	251	ABRIA4022	253	ABSA100125	259	ABTS022	293	ACHT8810E	62	AGP026028	259
ABREA4035	251	ABRIA4028	253	ABSA100200	259	ABTS025	293	ACHT8810L	62	AGP029031	259
ABREA4040	251	ABRIA4035	253	ABSA100300	259	ABTS028	293	ACHT8812C	62	AGP032035	259
ABREA4048	251	ABRIA4040	253	ABSA100400	259	ABTS032	293	ACHT8812L	62	AGP036039	259
ABREA4054	251	ABRIA4048	253	ABSA100500	259	ACHA08C	65	ACHT8816C	62	AGP040043	259
ABREA4060	251	ABRIA4054	253	ABSI003	270	ACHA09C	65	ACHT8816L	62	AGP044047	259
ABREA4075	251	ABRIA4060	253	ABSI004	270	ACHA10C	65	ACHT8820C	62	AGP048051	259
ABREA4090	251	ABRIA4075	253	ABSI005	270	ACHA11C	65	ACHTA208C	61	AGP052055	259
ABREA4110	251	ABRIA4090	253	ABSI006	270	ACHA12C	65	ACHTA208L	61	AGP056059	259
ABREA4115	251	ABRIA4110	253	ABSI007	270	ACHA14C	65	ACHTA209C	61	AGP060063	259
ABREA4125	251	ABRIA4115	253	ABSI008	270	ACHA16C	65	ACHTA209L	61	AGP064067	259
ABREA4140	251	ABRIA4125	253	ABSI009	270	ACHAA208C	65	ACHTA210C	61	AGP068073	259
ABREA4160	251	ABRIA4140	253	ABSI010	270	ACHAA210C	65	ACHTA210L	61	AGP074079	259
ABREA4200	251	ABRIA4160	253	ABSI011	270	ACHAA212C	65	ACHTA211C	61	AGP080085	259
ABRI018	252	ABRID016	254	ABSI012	270	ACHAFO08C	65	ACHTA211L	61	AGP086091	259
ABRI022	252	ABRID020	254	ABSI013	270	ACHAFO10C	65	ACHTA212C	61	AGP092097	259
ABRI028	252	ABRID025	254	ABSI014	270	ACHAFO12C	65	ACHTA212L	61	AGP098103	259
ABRI035	252	ABRID032	254	ABSI015	270	ACHE08C	63	ACHTA214C	61	AGP104112	259
ABRI040	252	ABRID040	254	ABSI016	270	ACHE09C	63	ACHTA214L	61	AGP113121	259
ABRI048	252	ABRID050	254	ABSI017	270	ACHE10C	63	ACHTA216C	61	AGP122130	259
ABRI054	252	ABRID063	254	ABSI018	270	ACHE10L	63	ACHTA216L	61	AGP131139	259
ABRI060	252	ABRID075	254	ABSI019	270	ACHE11C	63	ACHTA220C	61	AGP140148	259
ABRI070	252	ABRID090	254	ABSI020	270	ACHE11L	63	ACHTPI08C	62	AGP149161	259
ABRI075	252	ABRID110	254	ABSI021	270	ACHE12C	63	ACHTPI08L	62	AGP162174	259
ABRI083	252	ABRID125	254	ABSI022	270	ACHE12L	63	ACHTPI10C	62	AH06060	46
ABRI090	252	ABRID140	254	ABSI025	270	ACHE14C	63	ACHTPI10L	62	AH06070	46
ABRI100	252	ABRID160	254	ABTA0630	329	ACHE14L	63	ACHTPI12C	62	AH06080	46
ABRI110	252	ABRT3509	166	ABTA0640	329	ACHG08C	64	ACHTPI12L	62	AH06090	46
ABRI115	252	ABRT3513	166	ABTA0650	329	ACHG09C	64	ACHTPL08C	62	AH06100	46
ABRI125	252	ABRT3516	166	ABTA0730	329	ACHG10C	64	ACHTPL08L	62	AH06110	46
ABRI133	252	ABRT3519	166	ABTA0740	329	ACHG11C	64	ACHTPL10C	62	AH06120	46
ABRI140	252	ABRT3913	166	ABTA0750	329	ACHG12C	64	ACHTPL10L	62	AH06130	46
ABRI150	252	ABRT3916	166	ABTA0760	329	ACHG14C	64	ACHTPL12C	62	AH06140	46
ABRI160	252	ABRT3919	166	ABTA0770	329	ACHG16C	64	ACHTPL12L	62	AH06150	46
ABRI180	252	ABRT3925	166	ABTA0780	329	ACHGA208C	64	ADUTC47	140	AH06160	46
ABRI200	252	ABRT4213	166	ABTA0840	329	ACHGA210C	64	ADUTC60	140	AH06170	46
ABRI220	252	ABRT4216	166	ABTA0860	329	ACHGA212C	64	AFAZI44819	198	AH06180	46
ABRI250	252	ABRT4219	166	ABTA0880	329	ACHGEI0	64	AFAZI44828	198	AH08060	46
ABRI280	252	ABRT4225	166	ABTA1050	329	ACHGEI2	64	AFAZI44835	198	AH08075	46
ABRI300	252	ABRT4232	166	ABTA1070	329	ACHGFO08C	64	AFBLI44819	199	AH08090	46
ABRI315	252	ABRT4238	166	ABTA1090	329	ACHGFO10C	64	AFBLI44828	199	AH08100	46
ABRI355	252	ABRT4250	166	ABTA20630	330	ACHGFO12C	64	AFBLI44835	199	AH08115	46
ABRI400	252	ABRT4810	166	ABTAB0630	329	ACHINB08C	63	AFGRI44819	199	AH08120	46
ABRI450	252	ABRT4811	166	ABTAB0640	329	ACHINB08L	63	AFGRI44828	199	AH08130	46
ABRI500	252	ABRT4812	166	ABTAB0650	329	ACHINB10C	63	AFGRI44835	199	AH08155	46
ABRI560	252	ABRT4813	166	ABTC020	293	ACHINBI0L	63	AFMCI44819	198	AH10070	46
ABRI600	252	ABRT4816	166	ABTC025	293	ACHINN08C	63	AFMCI44828	198	AH10080	46
ABRI630	252	ABRT4819	166	ABTD016	293	ACHINN08L	63	AFMCI44835	198	AH10090	46
ABRI710	252	ABRT4825	166	ABTD018	293	ACHINN10C	63	AFMDI44819	198	AH10100	46
ABRI800	252	ABRT4832	166	ABTD020	293	ACHINN10L	63	AFMDI44828	198	AH10120	46
ABRI900	252	ABRT4838	166	ABTD022	293	ACHT08C	61	AFMDI44835	198	AH10140	46
ABRI910	252	ABRT4845	166	ABTD025	293	ACHT08L	61	AFNEI44819	199	AH10150	46
ABRI911	252	ABRT4850	166	ABTD028	293	ACHT09C	61	AFNEI44828	199	AH10160	46
ABRI912	252	ABRT4860	166	ABTG4530	330	ACHT09L	61	AFNEI44835	199	AH10170	46
ABRIA2018	253	ABRT4880	166	ABTG4535	330	ACHTI0C	61	AFPGI44819	199	AH10210	46

Ref	pag	Ref	pag	Ref	pag	Ref	pag	Ref	pag	Ref	pag
AH10230	46	AHICA0855	74	ALHA23130	205	AM06100	49	ANFA2323	76	APAT10115	44
AH12090	46	AHICA1065	74	ALHAB16030	205	AM06110	49	ANFA2330	76	APAT10135	44
AH12100	46	AHICA1275	74	ALHAB17040	205	AM06120	49	ANFA2335	76	APAT10165	44
AH12110	46	AHICA1690	74	ALHAB18050	205	AM06130	49	ANFA5114	76	APAT10185	44
AH12120	46	AHIC10645	74	ALHAB19060	205	AM06140	49	ANFA5116	76	APAT12100	44
AH12130	46	AHIC10855	74	ALHC14025	204	AM06150	49	ANFA5120	76	APAT12110	44
AH12140	46	AHIC11065	74	ALHC16030	204	AM06160	49	ANFA5124	76	APAT12120	44
AH12160	46	AHIGA0645	74	ALHC17040	204	AM06170	49	ANFATA37B	76	APAT12130	44
AH12180	46	AHIGA0855	74	ALHC18040	204	AM06180	49	ANFATA70B	76	APAT12150	44
AH12200	46	AHIGA1065	74	ALHC18050	204	AM08050	49	ANFAZ5021	76	APAT12180	44
AH12220	46	AHIGA1275	74	ALHC19050	204	AM08060	49	AP08050	43	APAT12200	44
AH12250	46	AHIGA1690	74	ALHC19060	204	AM08065	49	AP08075	43	APAT16145	44
AH14120	46	AHITO0645	74	ALHC19070	204	AM08075	49	AP08095	43	APAT16175	44
AH14145	46	AHITO0855	74	ALHC20050	204	AM08090	49	AP08115	43	APAT16220	44
AH14170	46	AHITO1065	74	ALHC20060	204	AM08115	49	API0090	43	APAT20170	44
AH14220	46	AHITO1275	74	ALHC20070	204	AM08120	49	API0105	43	APAT20200	44
AH14250	46	AHITO1690	74	ALHC20080	204	AM08130	49	API0115	43	APEN71	220
AH16125	46	AIS08080	108	ALHC21070	204	AM08155	49	API0135	43	APEN91	220
AH16145	46	AIS08100	108	ALHC21080	204	AM10065	49	API0165	43	APFL801020	219
AH16170	46	AIS08120	108	ALHC21090	204	AM10070	49	API0185	43	APFUZ100	219
AH16220	46	AIS08140	108	ALHC21100	204	AM10080	49	API2080	43	APG06060	45
AH16250	46	AISAM085	109	ALHC22110	204	AM10090	49	API2100	43	APG06070	45
AH16280	46	AIS10070	108	ALHC22120	204	AM10100	49	API2110	43	APG06100	45
AH20170	46	AISC10090	108	ALHC23130	204	AM10120	49	API2120	43	APG08050	45
AH20220	46	AISC10100	108	ALHCB16030	204	AM10140	49	API2130	43	APG08060	45
AH20270	46	AISC10120	108	ALHCB17040	204	AM10150	49	API2150	43	APG08075	45
AHAT06060	47	AISC10140	108	ALHCB18050	204	AM10160	49	API2180	43	APG08095	45
AHAT06080	47	AISC10160	108	ALHCB19060	204	AM10170	49	API2200	43	APG08115	45
AHAT06100	47	AISC10180	108	ALPL45060	202	AM10210	49	API6145	43	APG10070	45
AHAT08060	47	AISC10200	108	ALPL45080	202	AM10230	49	API6175	43	APG10090	45
AHAT08075	47	AISC10220	108	ALPL45100	202	AM12075	49	API6220	43	APG10105	45
AHAT08090	47	AISC10260	108	ALPL50120	202	AM12080	49	API6250	43	APG10115	45
AHAT08115	47	AISM08090	109	ALRE20015	202	AM12090	49	AP20170	43	APG10135	45
AHAT08130	47	AISM08110	109	ALRE25020	202	AM12100	49	AP20200	43	APG10165	45
AHAT08155	47	AISM08120	109	ALRE25025	202	AM12110	49	AP24205	43	APG10185	45
AHAT10070	47	AISM08140	109	ALRE25030	202	AM12120	49	AP24235	43	APG12080	45
AHAT10080	47	AISM08170	109	ALRE35040	202	AM12140	49	APA408075	43	APG12110	45
AHAT10090	47	AISM08200	109	ALRE35050	202	AM12160	49	APA408095	43	APG12130	45
AHAT10100	47	AISM08250	109	ALRE40060	202	AM12180	49	APA408115	43	APG12150	45
AHAT10120	47	AISM08300	109	ALRE40070	202	AM12220	49	APA408135	43	APG12180	45
AHAT10140	47	AISR140	108	ALRE40080	202	AM12250	49	APA410090	43	APG12200	45
AHAT10150	47	AISS10070	108	ALRO14025	203	AM14080	49	APA410105	43	APG16125	45
AHAT10160	47	AISS10090	108	ALRO16030	203	AM14100	49	APA410115	43	APG16145	45
AHAT10170	47	AISS10100	108	ALRO17040	203	AM14120	49	APA410135	43	APG16175	45
AHAT10210	47	AISS10120	108	ALRO18040	203	AM14145	49	APA410165	43	APG16220	45
AHAT12090	47	AISS10140	108	ALRO18050	203	AM14170	49	APA410185	43	APG20170	45
AHAT12100	47	AISS10160	108	ALRO19050	203	AM14220	49	APA412110	43	APG20200	45
AHAT12110	47	AISS10180	108	ALRO19060	203	AM14250	49	APA412120	43	APPD100	219
AHAT12130	47	AISS10200	108	ALRO19070	203	AM16090	49	APA412130	43	APPG070	219
AHAT12140	47	AISS10220	108	ALRO20060	203	AM16110	49	APA412150	43	APPG100	219
AHAT12160	47	AISS10260	108	ALRO20070	203	AM16125	49	APA412180	43	APPT071	220
AHAT12180	47	AISW060	109	ALRO20080	203	AM16145	49	APA412200	43	APPT091	220
AHAT12200	47	ALHA14025	205	ALRO21080	203	AM16170	49	APA416125	43	APPT101	220
AHAT12220	47	ALHA16030	205	ALRO21090	203	AM16220	49	APA416145	43	APSB71	220
AHAT12250	47	ALHA17040	205	ALRO22100	203	AM16250	49	APA416175	43	APSB91	220
AHAT16125	47	ALHA18040	205	ALRO22110	203	AM16280	49	APA416190	43	APUEZ200	220
AHAT16145	47	ALHA18050	205	ALRO22120	203	AM20120	49	APA416220	43	APX08050	44
AHAT16170	47	ALHA19050	205	ALRO23130	203	AM20170	49	APA420200	43	APX08075	44
AHAT16220	47	ALHA19060	205	ALROB16030	203	AM20220	49	APA420240	43	APX08080	44
AHAT16250	47	ALHA19070	205	ALROB17040	203	AM20270	49	APA420285	43	APX08095	44
AHAT16280	47	ALHA20050	205	ALROB18050	203	AM24180	49	APAR070	219	APX08115	44
AHAT20170	47	ALHA20060	205	ALROB19060	203	AM24260	49	APAR150	219	APX10090	44
AHAT20220	47	ALHA20070	205	AM06045	49	ANCLA40	116	APAT071	219	APX10105	44
AHAT20270	47	ALHA20080	205	AM06055	49	ANCLA47	116	APAT08075	44	APX10115	44
AHIAR0645	74	ALHA21070	205	AM06060	49	ANCU06040	70	APAT08095	44	APX10135	44
AHIAR0855	74	ALHA21080	205	AM06065	49	ANCU06070	70	APAT08115	44	APX10165	44
AHIAR1065	74	ALHA21090	205	AM06070	49	ANFA2309	76	APAT091	219	APX10185	44
AHIAR1275	74	ALHA21100	205	AM06080	49	ANFA2312	76	APAT10090	44	APX12080	44
AHIAR1690	74	ALHA22110	205	AM06085	49	ANFA2316	76	APAT101	219	APX12100	44
AHICA0645	74	ALHA22120	205	AM06090	49	ANFA2319	76	APAT10105	44	APX12110	44

Ref	pag	Ref	pag	Ref	pag	Ref	pag	Ref	pag	Ref	pag
APX12120	44	ASF2012020	271	AUE186350	159	AZAMG08	73	BB48200	286	BIE164825	157
APX12130	44	ASF2016027	271	AUE186360	159	AZAMG10	73	BB48250	286	BIE165525	157
APX12150	44	ASF2020032	271	AUE186380	159	AZAMG12	73	BB48290	286	BIE165532	157
APX12180	44	ASF2025040	271	AUE256325	159	AZAMGFO06	73	BB48370	286	BIE165538	157
APX12200	44	ASF2032050	271	AUE6310	158	AZAMGFO08	73	BB48430	286	BIE165550	157
APX12220	44	ASF2040060	271	AUE6311	158	AZAMGFO10	73	BB76150	286	BIE165558	157
APX12255	44	ASF2050070	271	AUE6312	158	AZAMGFO12	73	BB76200	286	BIE165565	157
APX16145	44	ASF2060080	271	AUE6313	158	AZAMT06	72	BB76290	286	BIE165580	157
APX16175	44	ASF2070090	271	AUE6314	158	AZAMT08	72	BB76370	286	BIE166325	157
APX16220	44	ASF2080100	271	AUE6315	158	AZAMT10	72	BB76450	286	BIE4825	157
APX16250	44	ASF2090110	271	AUE6319	158	AZAMT12	72	BB76540	286	BIE5525	157
APX20170	44	ASF2100120	271	AUE6325	158	AZAMT16	72	BB88770	286	BIE5532	157
APX20200	44	ASF2110130	271	AUE6332	158	AZIM060250	258	BBANA19	290	BIE5538	157
ARANE14	161	ASF2120140	271	AUE6340	158	AZIM060375	258	BBANA27	290	BIE5550	157
ARANE16	161	ASF2130150	271	AUE6350	158	AZIM060500	258	BBANE19	290	BIE5558	157
ARANE18	161	ASFIR03	272	AUE6360	158	AZIM060750	258	BBANE27	290	BIE5565	157
ARANE25	161	ASFIR30	272	AUE6380	158	AZIM061000	258	BC25100AM	287	BIE5580	157
ARE164816	156	ASFIRCA	272	AUENI166325	159	AZIM061250	258	BC25100AZ	288	BIE6325	157
ARE164819	156	ATA4832	169	AUTO16510	157	AZIM081500	258	BC25100GR	287	BN12100	285
ARE165522	156	ATA4838	169	AUTO16532	157	AZIM082000	258	BC25100MA	287	BN12225	285
ARE166320	156	ATA4845	169	AUTO16538	157	AZIM082250	258	BC25100RO	288	BN12500	285
ARE166325	156	ATA4850	169	AUTO16550	157	AZIM082500	258	BC25100VE	287	BN12720	285
ARE166332	156	ATA5538	169	AUTO16560	157	AZIM083000	258	BC36140AM	287	BN12850	285
ARE166338	156	ATA5545	169	AUTO16580	157	AZIM083500	258	BC36140AZ	288	BN25080	285
ARE166350	156	ATA5550	169	AUTO510	157	AZIM084000	258	BC36140GR	287	BN25100	285
ARE4816	156	ATA5555	169	AUTO532	157	AZIM084500	258	BC36140MA	287	BN25140	285
ARE4819	156	ATA5565	169	AUTO538	157	AZIM085000	258	BC36140RO	288	BN25160	285
ARE5522	156	ATA6310	169	AUTO550	157	AZIM086000	258	BC36140VE	287	BN25200	285
ARE6320	156	ATA6350	169	AUTO560	157	AZIM103000	258	BC36200AM	287	BN36140	285
ARE6325	156	ATA6360	169	AUTO580	157	AZIM103500	258	BC36200AZ	288	BN36200	285
ARE6332	156	ATA6370	169	AVC08120	75	AZIM104000	258	BC36200GR	287	BN36250	285
ARE6338	156	ATA6385	169	AVC08150	75	AZIM105000	258	BC36200MA	287	BN36300	285
ARE6350	156	ATAPO08AR	162	AVC10120	75	AZIM106000	258	BC36200RO	288	BN36370	285
ARE6363	156	ATAPO08BO	162	AVC10150	75	AZIM108000	258	BC36200VE	287	BN48120	285
ARE6380	156	ATAPO08BP	162	AVC10180	75	BAESM04	112	BC48200AM	287	BN48160	285
ARENII66325	156	ATAPO08BS	162	AVR08120	75	BAESM05	112	BC48200AZ	288	BN48180	285
ARFOM06Z	328	ATAPO08GM	162	AVR08150	75	BAESM06	112	BC48200GR	287	BN48200	285
ARFOM08Z	328	ATAPO08NE	162	AVR10120	75	BAESM08	112	BC48200MA	287	BN48250	285
ARFOM10Z	328	ATAPO08PC	162	AVR10150	75	BAGAM04	112	BC48200RO	288	BN48290	285
ARFOM12Z	328	ATAPO08RC	162	AVR10180	75	BAGAM05	112	BC48200VE	287	BN48370	285
ARFOM16Z	328	ATAPO08RT	162	AZA2060500	258	BAGAM06	112	BC48290AM	287	BN48430	285
ARINO14	161	ATAPO08RX	162	AZA2060750	258	BAGAM08	112	BC48290AZ	288	BN76150	285
ARINO16	161	ATAPO08VN	162	AZA2061000	258	BAUTO165510	158	BC48290GR	287	BN76200	285
ARINO18	161	ATAPO10AR	162	AZA2061250	258	BAUTO165540	158	BC48290MA	287	BN76290	285
ARINO25	161	ATAPO10BO	162	AZA2081500	258	BAUTO165550	158	BC48290RO	288	BN76370	285
ARINOM30	161	ATAPO10BP	162	AZA2082000	258	BAUTO165565	158	BC48290VE	287	BN76450	285
ARPAR25	161	ATAPO10BS	162	AZA2082500	258	BAUTO165580	158	BCPA24214	170	BN76540	285
ARPARA225	161	ATAPO10GM	162	AZA2083000	258	BAUTO5510	158	BCPA24223	170	BN88770	285
ARSP08	318	ATAPO10NE	162	AZA2104000	258	BAUTO5540	158	BCPB4214	170	BNDT25100	288
ARSP10	318	ATAPO10PC	162	AZA2106000	258	BAUTO5550	158	BCPB4223	170	BNDT36150	288
ARSS10	318	ATAPO10RC	162	AZA2108000	258	BAUTO5565	158	BCPN4214	170	BNDT36200	288
ARSS12	318	ATAPO10RT	162	AZAMA06	73	BAUTO5580	158	BCPN4223	170	BNDT48200	288
ASF008016	271	ATAPO10RX	162	AZAMA08	73	BB12100	286	BCPZ4214	170	BNDT48300	288
ASF012022	271	ATAPO10VN	162	AZAMA10	73	BB12225	286	BCPZ4214BL	170	BNDT48370	288
ASF016027	271	AUE166319	159	AZAMA12	73	BB12500	286	BCPZ4223	170	BNDT76370	288
ASF020032	271	AUE166325	159	AZAMAF006	73	BB12720	286	BCPZ4223BL	170	BOCA006	242
ASF025040	271	AUE166332	159	AZAMAF008	73	BB12850	286	BHDS06010	240	BOCA007	242
ASF030045	271	AUE166340	159	AZAMAF010	73	BB25080	286	BHDS06160	240	BOCA008	242
ASF035050	271	AUE166350	159	AZAMAF012	73	BB25100	286	BHDS06210	240	BOCA010	242
ASF040060	271	AUE166360	159	AZAMC06	72	BB25140	286	BHDS08110	240	BOCA013	242
ASF050070	271	AUE166380	159	AZAMC08	72	BB25160	286	BHDS08160	240	BOCA055	242
ASF060080	271	AUE186310	159	AZAMC10	72	BB25200	286	BHDS08210	240	BPL02616	289
ASF070090	271	AUE186311	159	AZAMC12	72	BB36140	286	BHDS10160	240	BZ1251M04	235
ASF080100	271	AUE186312	159	AZAMC16	72	BB36200	286	BHDS10210	240	BZ1251M05	235
ASF090110	271	AUE186313	159	AZAME06	72	BB36250	286	BHDS12160	240	BZ1251M06	235
ASF100120	271	AUE186314	159	AZAME08	72	BB36300	286	BHDS12210	240	BZ1251M08	235
ASF110130	271	AUE186315	159	AZAME10	72	BB36370	286	BHDS16210	240	BZ1251M10	235
ASF120140	271	AUE186325	159	AZAME12	72	BB48120	286	BHDS16310	240	BZ1252M03	235
ASF130150	271	AUE186332	159	AZAME16	72	BB48160	286	BID25110	289	BZ1252M04	235
ASF2010016	271	AUE186340	159	AZAMG06	73	BB48180	286	BID25210	289	BZ1252M05	235

Ref	pag	Ref	pag	Ref	pag	Ref	pag	Ref	pag	Ref	pag
BZ125ZM06	235	BZ3Z06025	223	BZ934ZM03	232	BZABR4845	164	BZALHCB1740	204	BZASF025040	271
BZ125ZM08	235	BZ3Z06030	223	BZ934ZM04	232	BZABR4850	164	BZALHCB1850	204	BZBAESM04	112
BZ125ZM10	235	BZ3Z06040	223	BZ934ZM05	232	BZABR4860	164	BZALHCB1960	204	BZBAESM05	112
BZ125ZM12	235	BZ3Z06050	223	BZ934ZM06	232	BZACHA08C	65	BZALHCT04	103	BZBAESM06	112
BZ12703	237	BZ3Z06060	223	BZ934ZM08	232	BZACHAI0C	65	BZALHCT05	103	BZBAGAM04	112
BZ12704	237	BZ3Z06070	223	BZ934ZM10	232	BZACHAI2C	65	BZALHCT06	103	BZBAGAM05	112
BZ12705	237	BZ3Z08016	223	BZ934ZM12	232	BZACHG08C	64	BZALHCT08	103	BZBAGAM06	112
BZ12706	237	BZ3Z08020	223	BZ985IM04	233	BZACHGI0C	64	BZALHCTS05	101	BZBB25100	286
BZ12708	237	BZ3Z08025	223	BZ985IM05	233	BZACHGI2C	64	BZALHCTS06	101	BZBB25160	286
BZ12710	237	BZ3Z08030	223	BZ985IM06	233	BZACHINB08C	63	BZALHCTS08	101	BZBB25200	286
BZ12712	237	BZ3Z08040	223	BZ985IM08	233	BZACHINB10C	63	BZALPL45060	202	BZBB36140	286
BZ158704	234	BZ3Z08050	223	BZ985IM10	233	BZACHT08C	61	BZALPL45080	202	BZBB36200	286
BZ158705	234	BZ3Z08060	223	BZABE144819	155	BZACHT08L	61	BZALPL45100	202	BZBB36300	286
BZ158706	234	BZ3Z08070	223	BZABE144825	155	BZACHT10C	61	BZALPL50120	202	BZBB48160	286
BZ158708	234	BZ3Z08080	223	BZABE164819	155	BZACHT10L	61	BZALRE20015	202	BZBB48200	286
BZ158710	234	BZ3Z10030	223	BZABE165522	155	BZACHT12C	61	BZALRE25020	202	BZBB48290	286
BZ158712	234	BZ3Z10040	223	BZABE165525	155	BZACHT12L	61	BZALRE25025	202	BZBB48370	286
BZ3104010	224	BZ3Z10050	223	BZABE165532	155	BZACHTA208C	61	BZALRE25030	202	BZBN25100	285
BZ3104016	224	BZ603905020	228	BZABE165538	155	BZACHTA208L	61	BZALRE35040	202	BZBN25160	285
BZ3104020	224	BZ603905030	228	BZABE165550	155	BZACHTA210C	61	BZALRE35050	202	BZBN25200	285
BZ3104030	224	BZ603905040	228	BZABE166325	155	BZACHTA210L	61	BZALRE40060	202	BZBN36140	285
BZ3104040	224	BZ603905050	228	BZABE166332	155	BZAGP023025	259	BZALRE40070	202	BZBN36200	285
BZ3105010	224	BZ603906016	228	BZABE166338	155	BZAGP029031	259	BZALRE40080	202	BZBN36300	285
BZ3105016	224	BZ603906020	228	BZABE3509	154	BZAGP040043	259	BZALRO14025	203	BZBN48160	285
BZ3105020	224	BZ603906030	228	BZABE3513	154	BZALHA14025	205	BZALRO16030	203	BZBN48200	285
BZ3105030	224	BZ603906040	228	BZABE4213	154	BZALHA16030	205	BZALRO17040	203	BZBN48290	285
BZ3105040	224	BZ603906050	228	BZABE4216	154	BZALHA17040	205	BZALRO18040	203	BZBN48370	285
BZ3105050	224	BZ603906060	228	BZABE4219	154	BZALHA18040	205	BZALRO18050	203	BZBOCA008	242
BZ3106016	224	BZ603906070	228	BZABE4225	154	BZALHA18050	205	BZALRO19050	203	BZBOCA010	242
BZ3106020	224	BZ603906080	228	BZABE4813	154	BZALHA19050	205	BZALRO19060	203	BZCFBL	208
BZ3106025	224	BZ603908025	228	BZABE4816	154	BZALHA19060	205	BZALRO19070	203	BZGDZ03	130
BZ3106030	224	BZ603908030	228	BZABE4819	154	BZALHA19070	205	BZALRO20060	203	BZGDZ04	130
BZ3106040	224	BZ603908040	228	BZABE4825	154	BZALHA20060	205	BZALRO20070	203	BZGDZ05	130
BZ3106050	224	BZ603908050	228	BZABE4832	154	BZALHA20070	205	BZALRO21080	203	BZGDZ06	130
BZ3108016	224	BZ603908060	228	BZABE4838	154	BZALHA20080	205	BZALRO21090	203	BZGMZ08012	208
BZ3108020	224	BZ603908070	228	BZABE5519	154	BZALHA21080	205	BZALRO22100	203	BZGMZ10016	208
BZ3108025	224	BZ603908080	228	BZABE5522	154	BZALHA21090	205	BZALRO22110	203	BZGMZ12020	208
BZ3108030	224	BZ603908090	228	BZABE5525	154	BZALHA21100	205	BZALRO22120	203	BZGMZ15026	208
BZ3108040	224	BZ603910025	228	BZABE5532	154	BZALHA22110	205	BZALRO23130	203	BZGMZ17030	208
BZ3108050	224	BZ603910030	228	BZABE5538	154	BZALHA22120	205	BZALROB1630	203	BZGMZ19035	208
BZ3108060	224	BZ603910040	228	BZABE5550	154	BZALHA23130	205	BZALROB1740	203	BZGRB001	295
BZ3110020	224	BZ603910050	228	BZABE6325	154	BZALHAB1630	205	BZALROB1850	203	BZGRB010	295
BZ3110030	224	BZ902103	236	BZABE6332	154	BZALHAB1740	205	BZALROB1960	203	BZGRB050	295
BZ3110040	224	BZ902104	236	BZABE6338	154	BZALHAB1850	205	BZALROT04	103	BZGRB060	295
BZ3Z04008	223	BZ902105	236	BZABE6350	154	BZALHAB1960	205	BZALROT05	103	BZGRB070	295
BZ3Z04010	223	BZ902106	236	BZABP3513	167	BZALHAT04	103	BZALROT06	103	BZGRB080	295
BZ3Z04012	223	BZ902108	236	BZABP3516	167	BZALHAT05	103	BZALROT08	103	BZGRB090	295
BZ3Z04016	223	BZ902110	236	BZABP4219	167	BZALHAT06	103	BZALROTS05	101	BZGRB100	295
BZ3Z04020	223	BZ902112	236	BZABP4225	167	BZALHAT08	103	BZALROTS06	101	BZGRB120	295
BZ3Z04025	223	BZ90211M04	236	BZABP4232	167	BZALHATS05	101	BZALROTS08	101	BZGRZ05	129
BZ3Z04030	223	BZ90211M05	236	BZABPI016	269	BZALHATS06	101	BZAM06060	49	BZGRZ06	129
BZ3Z04035	223	BZ90211M06	236	BZABPI018	269	BZALHATS08	101	BZAM06080	49	BZGRZ08	129
BZ3Z04040	223	BZ90211M08	236	BZABPI020	269	BZALHC14025	204	BZAM08050	49	BZGRZ10	129
BZ3Z04045	223	BZ90211M10	236	BZABPI022	269	BZALHC16030	204	BZAM08075	49	BZHARM03026	206
BZ3Z04050	223	BZ93106030	225	BZABPI025	269	BZALHC17040	204	BZAM08090	49	BZHARM04035	206
BZ3Z04060	223	BZ93106040	225	BZABPI028	269	BZALHC18040	204	BZAM10070	49	BZHARM05037	206
BZ3Z05010	223	BZ93106050	225	BZABPI032	269	BZALHC18050	204	BZAM10090	49	BZHARM06050	206
BZ3Z05012	223	BZ93106060	225	BZABR3509	164	BZALHC19050	204	BZAM10120	49	BZHARM08060	206
BZ3Z05015	223	BZ93106070	225	BZABR3513	164	BZALHC19060	204	BZAM12090	49	BZHCRM03026	206
BZ3Z05016	223	BZ93108030	225	BZABR3516	164	BZALHC19070	204	BZAM12110	49	BZHCRM04035	206
BZ3Z05020	223	BZ93108040	225	BZABR4213	164	BZALHC20060	204	BZAM12140	49	BZHCRM05037	206
BZ3Z05025	223	BZ93108050	225	BZABR4216	164	BZALHC20070	204	BZANCLA40	116	BZHCRM06050	206
BZ3Z05030	223	BZ93108060	225	BZABR4219	164	BZALHC20080	204	BZANCLA47	116	BZHCRM08060	206
BZ3Z05035	223	BZ93108070	225	BZABR4225	164	BZALHC21080	204	BZARANE14	161	BZHCRM10065	206
BZ3Z05040	223	BZ93108080	225	BZABR4232	164	BZALHC21090	204	BZARANE16	161	BZHENOM06	68
BZ3Z05045	223	BZ9341M04	232	BZABR4816	164	BZALHC21100	204	BZARANE18	161	BZHENOM08	68
BZ3Z05050	223	BZ9341M05	232	BZABR4819	164	BZALHC22110	204	BZASF008016	271	BZHENOM10	68
BZ3Z05060	223	BZ9341M06	232	BZABR4825	164	BZALHC22120	204	BZASF012022	271	BZINCO432	114
BZ3Z06016	223	BZ9341M08	232	BZABR4832	164	BZALHC23130	204	BZASF016027	271	BZINCO438	114
BZ3Z06020	223	BZ9341M10	232	BZABR4838	164	BZALHCB1630	204	BZASF020032	271	BZINCO537	114

Ref	pag	Ref	pag	Ref	pag	Ref	pag	Ref	pag		
BZINCO552	114	BZRENO3208	118	BZT9850510Z	230	BZTNXA08120	95	BZTPTPADPI	243	BZTXZP35035	181
BZINCO565	114	BZRENO3210	118	BZT9850520Z	230	BZTNXA10080	95	BZTPTPADRO	243	BZTXZP35040	181
BZINCO637	114	BZRENO4008	118	BZT9850525Z	230	BZTNXA10100	95	BZTPTPADSA	243	BZTXZP35050	181
BZINCO652	114	BZRENO4010	118	BZT9850530Z	230	BZTNXA10120	95	BZTRA6050	75	BZTXZP40025	181
BZINVN7060	196	BZRENO4012	118	BZT9850540Z	230	BZTNXE08080	95	BZTRA6060	75	BZTXZP40030	181
BZINVN7070	196	BZRENO4016	118	BZT9850610Z	230	BZTNXE08100	95	BZTRA6080	75	BZTXZP40035	181
BZINVN7080	196	BZRENO4810	118	BZT9850616Z	230	BZTNXE08120	95	BZTRA8070	75	BZTXZP40040	181
BZINVZ7060	195	BZRENO4812	118	BZT9850620Z	230	BZTNXE10080	95	BZTRA8090	75	BZTXZP40045	181
BZINVZ7070	195	BZRENO4816	118	BZT9850625Z	230	BZTNXE10100	95	BZTRA8110	75	BZTXZP40050	181
BZINVZ7080	195	BZRENO4820	118	BZT9850630Z	230	BZTNXE10120	95	BZTRA8130	75	BZTXZP40060	181
BZMAE0630	327	BZRENO4824	118	BZT9850640Z	230	BZTPPO25016	189	BZTRA8150	75	BZTXZP45030	181
BZMAE0825	327	BZSJJ20403	124	BZT9850650Z	230	BZTPPO25020	189	BZTRREPVO550	197	BZTXZP45035	181
BZMAE1030	327	BZSJJ20505	124	BZT9850660Z	230	BZTPPO25025	189	BZTRREPVO750	197	BZTXZP45040	181
BZMEDUB06	102	BZSJJ20506	124	BZTABRIBL8	289	BZTPPO30016	189	BZTREZ05050	197	BZTXZP45045	181
BZMEDUB08	102	BZSJJ20608	124	BZTABRINE8	289	BZTPPO30020	189	BZTREZ07050	197	BZTXZP45050	181
BZMEDUB10	102	BZSVCBL	209	BZTACON04	104	BZTPPO30025	189	BZTSGA06	126	BZTXZP45060	181
BZMI08075	48	BZSVCMA	209	BZTACON05	104	BZTPPO30030	189	BZTUMAM03	238	BZTXZP45070	181
BZMI10090	48	BZSVNB01	209	BZTACON06	104	BZTPPO35016	189	BZTUMAM04	238	BZTXZP50030	181
BZPACC15015	207	BZSVNB02	209	BZTACON08	104	BZTPPO35020	189	BZTUMAM05	238	BZTXZP50035	181
BZPACC15020	207	BZSVNM01	209	BZTACON10	104	BZTPPO35025	189	BZTUMAM06	238	BZTXZP50040	181
BZPACC15025	207	BZSVNM02	209	BZTACON12	104	BZTPPO35030	189	BZTUMAM08	238	BZTXZP50050	181
BZPACC20025	207	BZT8135009	172	BZTALAM06	69	BZTPPO35035	189	BZTUMAM10	238	BZTXZP50060	181
BZPACC20030	207	BZT8135013	172	BZTALAM08	69	BZTPPO35040	189	BZTUMAM12	238	BZTXZP50070	181
BZPACC20035	207	BZT8135016	172	BZTALAM10	69	BZTPPO35050	189	BZTXA250050	183	BZTXZP50080	181
BZPACC20040	207	BZT8135019	172	BZTAME06032	70	BZTPPO40016	189	BZTXA250060	183	BZTXZP60050	181
BZPACC20045	207	BZT8139013	172	BZTAME08038	70	BZTPPO40020	189	BZTXA250070	183	BZTXZP60060	181
BZPACC20050	207	BZT8139016	172	BZTAME08060	70	BZTPPO40025	189	BZTXBP30016	180	BZTXZP60070	181
BZPACP22520	207	BZT8139019	172	BZTAME10060	70	BZTPPO40030	189	BZTXBP30020	180	BZTXZP60080	181
BZPACP22525	207	BZT8139025	172	BZTAPLAME	116	BZTPPO40035	189	BZTXBP30025	180	BZZ98503	233
BZPACP22530	207	BZT8139032	172	BZTAPLANY	116	BZTPPO40040	189	BZTXBP30030	180	BZZ98504	233
BZPACP25040	207	BZT8142009	172	BZTB05030	194	BZTPPO40045	189	BZTXBP35016	180	BZZ98505	233
BZPACP25050	207	BZT8142013	172	BZTB05040	194	BZTPPO40050	189	BZTXBP35020	180	BZZ98506	233
BZPACP29060	207	BZT8142016	172	BZTB05050	194	BZTPPO40060	189	BZTXBP35025	180	BZZ98508	233
BZPACP29070	207	BZT8142019	172	BZTB06030	194	BZTPPO45030	189	BZTXBP35030	180	BZZ98510	233
BZPACP34040	207	BZT8142025	172	BZTB06040	194	BZTPPO45035	189	BZTXBP35035	180	BZZ98512	233
BZPACP34050	207	BZT8142032	172	BZTB06050	194	BZTPPO45040	189	BZTXBP35040	180	CABA004	112
BZPACP34060	207	BZT8142038	172	BZTB06060	194	BZTPPO45045	189	BZTXBP35050	180	CABA005	112
BZPACP34070	207	BZT8148016	172	BZTB06070	194	BZTPPO45050	189	BZTXBP40025	180	CABA006	112
BZPACX11010	208	BZT8148019	172	BZTB06080	194	BZTPPO45060	189	BZTXBP40030	180	CABA008	112
BZPACX13012	208	BZT8148025	172	BZTB07050	194	BZTPPO45070	189	BZTXBP40035	180	CABT47	140
BZPACX13020	208	BZT8148032	172	BZTB07060	194	BZTPPO50030	189	BZTXBP40040	180	CABT60	140
BZPACX15016	208	BZT8148038	172	BZTB07070	194	BZTPPO50035	189	BZTXBP40045	180	CAPA004	113
BZPACX15025	208	BZT8148050	172	BZTB08040	194	BZTPPO50040	189	BZTXBP40050	180	CAPA005	113
BZPACX18030	208	BZT8148060	172	BZTB08050	194	BZTPPO50050	189	BZTXBP40060	180	CAPA006	113
BZPAESM04	113	BZT8155025	172	BZTB08060	194	BZTPPO50060	189	BZTXBP45030	180	CAPA008	113
BZPAESM05	113	BZT8155032	172	BZTB08070	194	BZTPPO50070	189	BZTXBP45035	180	CAQU008	83
BZPAESM06	113	BZT8155038	172	BZTB08080	194	BZTPPO50080	189	BZTXBP45040	180	CAQU010	83
BZPAGAM04	113	BZT8155050	172	BZTB08090	194	BZTPPO50100	189	BZTXBP45045	180	CAQU012	83
BZPAGAM05	113	BZT8242019	173	BZTB08100	194	BZTPPO60040	189	BZTXBP45050	180	CAQU016	83
BZPAGAM06	113	BZT8242025	173	BZTB10050	194	BZTPPO60050	189	BZTXBP45060	180	CAQU020	83
BZPL35025	136	BZT8248025	173	BZTB10060	194	BZTPPO60060	189	BZTXBP45070	180	CAQU024	83
BZPL35035	136	BZT8248038	173	BZTB10080	194	BZTPPO60070	189	BZTXBP50030	180	CAQU030	83
BZPL35045	136	BZT9650410Z	231	BZTBTS10	101	BZTPPO60080	189	BZTXBP50035	180	CFBL	208
BZPUPHCL01	240	BZT9650420Z	231	BZTCCA05030	99	BZTPPO60090	189	BZTXBP50040	180	CIPE1208	272
BZPUPHCL02	240	BZT9650430Z	231	BZTCCA05050	99	BZTPPO60100	189	BZTXBP50050	180	CIPE1708	272
BZPUPHCL03	240	BZT9650510Z	231	BZTCCA06040	99	BZTPPOT04	103	BZTXBP50060	180	CIPEA21708	272
BZPUPOCL01	241	BZT9650520Z	231	BZTCCA06050	99	BZTPPOT05	103	BZTXBP50070	180	CIPR1208	273
BZPUPOCL02	241	BZT9650525Z	231	BZTCCA06060	99	BZTPPOT06	103	BZTXBP50080	180	CIPR1908	273
BZPUPOCL03	241	BZT9650530Z	231	BZTCCA06070	99	BZTPPOT08	103	BZTXBP60050	180	CKBB12225	286
BZPUTOT01	240	BZT9650620Z	231	BZTCCA08060	99	BZTPPOTS05	101	BZTXBP60060	180	CKBB25080	286
BZPUTOT02	240	BZT9650630Z	231	BZTCCA08080	99	BZTPPOTS06	101	BZTXBP60070	180	CKBB25100	286
BZRECA4010	119	BZT9650640Z	231	BZTCCA08100	99	BZTPPOTS08	101	BZTXBP60080	180	CKBB25140	286
BZRECA4012	119	BZT9850306Z	230	BZTCCA08120	99	BZTPPADBE	243	BZTXBP30016	181	CKBB25160	286
BZRECA4016	119	BZT9850310Z	230	BZTN4505	100	BZTPTPADBL	243	BZTXZP30020	181	CKBB25200	286
BZRECA4810	119	BZT9850316Z	230	BZTN4506	100	BZTPTPADCA	243	BZTXZP30025	181	CKBB36140	286
BZRECA4812	119	BZT9850320Z	230	BZTN4508	100	BZTPTPADCE	243	BZTXZP30030	181	CKBB36200	286
BZRECA4814	119	BZT9850330Z	230	BZTN4510	100	BZTPTPADGR	243	BZTXZP35016	181	CKBB36300	286
BZRECA4816	119	BZT9850416Z	230	BZTN4512	100	BZTPTPADHA	243	BZTXZP35020	181	CKBB36370	286
BZRECA4818	119	BZT9850420Z	230	BZTNXA08080	95	BZTPTPADNE	243	BZTXZP35025	181	CKBB48120	286
BZREFL4835	120	BZT9850430Z	230	BZTNXA08100	95	BZTPTPADNO	243	BZTXZP35030	181	CKBB48160	286

Ref	pag	Ref	pag	Ref	pag	Ref	pag	Ref	pag		
CKBB48180	286	CMTENSOTO	133	D1271M08	237	D603910110	228	D692108012	226	D91205010	227
CKBB48200	286	CMTENSOVE	133	D1271M10	237	D603910120	228	D692108016	226	D91205012	227
CKBB48250	286	CMUNAAGUJ	132	D1271M12	237	D603910130	228	D692108020	226	D91205016	227
CKBB48290	286	COAR08060	254	D158704	234	D603910140	228	D692108025	226	D91205020	227
CKBB48370	286	COARI0060	254	D158705	234	D603910150	228	D692108030	226	D91205025	227
CKBB76200	286	COKS08060	338	D158706	234	D603910160	228	D692108035	226	D91205030	227
CKBB76290	286	COSOI5400	338	D158708	234	D603910180	228	D692108040	226	D91205035	227
CKBB76370	286	COSOI5450	338	D158710	234	D603910200	228	D692108050	226	D91205040	227
CKBC25100AZ	288	COSOI5500	338	D158712	234	D603910203	228	D692108060	226	D91205045	227
CKBC25100MA	287	COSO20400	338	D158714	234	D603910205	228	D692110020	226	D91205050	227
CKBC25100RO	288	COSO20450	338	D158716	234	D603912040	228	D692110025	226	D91206010	227
CKBC25100VE	287	COSO20500	338	D603905016	228	D603912045	228	D692110030	226	D91206012	227
CKBC36140AZ	288	CPAC300453	138	D603905020	228	D603912050	228	D692110035	226	D91206016	227
CKBC36140MA	287	CPAC300703	138	D603905025	228	D603912060	228	D692110040	226	D91206020	227
CKBC36140RO	288	CPGV012	138	D603905030	228	D603912070	228	D692110050	226	D91206025	227
CKBC36140VE	287	CPGV030	138	D603905035	228	D603912080	228	D692112025	226	D91206030	227
CKBC36200AZ	288	CPMV020	138	D603905040	228	D603912100	228	D692112030	226	D91206035	227
CKBC36200MA	287	CPMV045	138	D603905045	228	D603912120	228	D692112035	226	D91206040	227
CKBC36200RO	288	CPMV090	138	D603905050	228	D603912140	228	D692112040	226	D91206045	227
CKBC36200VE	287	CPMV150	138	D603905060	228	D603912160	228	D692112045	226	D91206050	227
CKBC48200AZ	288	CPPA023	138	D603905070	228	D603912180	228	D692112050	226	D91206060	227
CKBC48200MA	287	CPPA075	138	D603905080	228	D603912200	228	D692112060	226	D91208010	227
CKBC48200RO	288	CPPAI50	138	D603906016	228	D603912220	228	D692304	234	D91208012	227
CKBC48200VE	287	CSB0104010	318	D603906020	228	D603912240	228	D692305	234	D91208016	227
CKBC48290AZ	288	CSB0108010	318	D603906025	228	D603912260	228	D692306	234	D91208020	227
CKBC48290MA	287	D12503	235	D603906030	228	D603912280	228	D692308	234	D91208025	227
CKBC48290RO	288	D12504	235	D603906035	228	D603912300	228	D692310	234	D91208030	227
CKBC48290VE	287	D12505	235	D603906040	228	D603108016	229	D692312	234	D91208035	227
CKBN12225	285	D12506	235	D603906045	228	D60810035	229	D692314	234	D91208040	227
CKBN25080	285	D12508	235	D603906050	228	D60810040	229	D692316	234	D91208045	227
CKBN25100	285	D12510	235	D603906060	228	D60810045	229	D69231M08	234	D91208050	227
CKBN25140	285	D12512	235	D603906070	228	D60810050	229	D69231M10	234	D91208060	227
CKBN25160	285	D12514	235	D603906080	228	D60810060	229	D69231M12	234	D91208070	227
CKBN25200	285	D12516	235	D603906090	228	D60811040	229	D902103	236	D91208080	227
CKBN36140	285	D12518	235	D603906100	228	D60811045	229	D902104	236	D91210016	227
CKBN36200	285	D12520	235	D603906110	228	D60811050	229	D902105	236	D91210020	227
CKBN36300	285	D12522	235	D603906120	228	D60811060	229	D902106	236	D91210025	227
CKBN36370	285	D12524	235	D603906130	228	D60811070	229	D902108	236	D91210030	227
CKBN48120	285	D12527	235	D603906140	228	D60811080	229	D902110	236	D91210035	227
CKBN48160	285	D12530	235	D603906150	228	D60811090	229	D902112	236	D91210040	227
CKBN48180	285	D12533	235	D603908016	228	D60812040	229	D902114	236	D91210045	227
CKBN48200	285	D12536	235	D603908020	228	D60812045	229	D902116	236	D91210050	227
CKBN48250	285	D1251M04	235	D603908025	228	D60812050	229	D902118	236	D91210060	227
CKBN48290	285	D1251M05	235	D603908030	228	D60812060	229	D902120	236	D91210070	227
CKBN48370	285	D1251M06	235	D603908035	228	D60812070	229	D902122	236	D91210080	227
CKBN76200	285	D1251M08	235	D603908040	228	D60812080	229	D902124	236	D91210090	227
CKBN76290	285	D1251M10	235	D603908045	228	D60812090	229	D90211M04	236	D91210100	227
CKBN76370	285	D1251M12	235	D603908050	228	D60812100	229	D90211M05	236	D91210200	227
CKTACOBRI06	289	D1251M14	235	D603908060	228	D6798A03	238	D90211M06	236	D91212025	227
CKTACOBRI08	289	D1251M16	235	D603908070	228	D6798A04	238	D90211M08	236	D91212030	227
CKTACOBRI09	289	D1251M18	235	D603908080	228	D6798A05	238	D90211M10	236	D91212035	227
CKTACOBRI08	289	D1251M20	235	D603908090	228	D6798A06	238	D90211M12	236	D91212040	227
CMBRPOS33	132	D1251M22	235	D603908100	228	D6798A08	238	D90211M14	236	D91212045	227
CMBRPOS40	132	D1251M24	235	D603908110	228	D6798A10	238	D90211M16	236	D91212050	227
CMBRPOS42	132	D12703	237	D603908120	228	D6798A12	238	D90211M18	236	D91212060	227
CMBRPOS48	132	D12704	237	D603908130	228	D6798A14	238	D90211M20	236	D91212070	227
CMBRPOS50	132	D12705	237	D603908140	228	D6798A16	238	D90211M22	236	D91212080	227
CMBRPOS60	132	D12706	237	D603908150	228	D692105010	226	D90211M24	236	D91212090	227
CMBRTEN48	132	D12708	237	D603910020	228	D692105012	226	D91204008	227	D91212100	227
CMTAPON33	132	D12710	237	D603910025	228	D692105016	226	D91204010	227	D91212110	227
CMTAPON40	132	D12712	237	D603910030	228	D692105020	226	D91204012	227	D91212120	227
CMTAPON42	132	D12714	237	D603910035	228	D692105025	226	D91204016	227	D931806030	225
CMTAPON48	132	D12716	237	D603910040	228	D692105030	226	D91204020	227	D931806035	225
CMTAPON50	132	D12718	237	D603910045	228	D692106010	226	D91204025	227	D931806040	225
CMTAPON60	132	D12720	237	D603910050	228	D692106012	226	D91204030	227	D931806045	225
CMTAPOS33	132	D12722	237	D603910060	228	D692106016	226	D91204035	227	D931806050	225
CMTAPOS40	132	D12724	237	D603910070	228	D692106020	226	D91204040	227	D931806060	225
CMTAPOS42	132	D12727	237	D603910080	228	D692106025	226	D91204045	227	D931806070	225
CMTAPOS48	132	D12730	237	D603910090	228	D692106030	226	D91204050	227	D931806080	225
CMTENSOAL	133	D12736	237	D603910100	228	D692106035	226	D91205008	227	D931808035	225

Ref	pag	Ref	pag	Ref	pag	Ref	pag	Ref	pag		
D931808040	225	D931818140	225	D93310045	222	D9331M04016	224	D9331M18040	224	EKMACFTL	342
D931808045	225	D931818150	225	D93310050	222	D9331M04020	224	D9331M18050	224	EKMACFTP	342
D931808050	225	D931820060	225	D93310060	222	D9331M04025	224	D9331M18060	224	EKMACILU	342
D931808060	225	D931820070	225	D93310070	222	D9331M04030	224	D9331M18070	224	EKMULAC	340
D931808070	225	D931820080	225	D93310080	222	D9331M04035	224	D9331M18080	224	EKMULAV08	341
D931808080	225	D931820090	225	D93310090	222	D9331M04040	224	D9331M18090	224	EKMULAV10	341
D931808090	225	D931820100	225	D93310100	222	D9331M05010	224	D9331M18100	224	EKMULCAL	341
D931808100	225	D931820110	225	D93312020	222	D9331M05016	224	D93403	232	EKMULCAN	340
D931808110	225	D931820120	225	D93312025	222	D9331M05020	224	D93404	232	EKMULCIS	341
D931808120	225	D931820130	225	D93312030	222	D9331M05025	224	D93405	232	EKMULFAE	340
D931808130	225	D931820140	225	D93312035	222	D9331M05030	224	D93406	232	EKMULFAL	343
D931808140	225	D931820150	225	D93312040	222	D9331M05035	224	D93408	232	EKMULFAP	343
D931808150	225	D93304008	222	D93312045	222	D9331M05040	224	D93410	232	EKMULRAD	341
D931810035	225	D93304010	222	D93312050	222	D9331M05050	224	D93412	232	EKMULROB	342
D931810040	225	D93304012	222	D93312060	222	D9331M06010	224	D93414	232	EKMULTEN	340
D931810045	225	D93304016	222	D93312070	222	D9331M06016	224	D93416	232	EKMULTOL	340
D931810050	225	D93304020	222	D93312080	222	D9331M06020	224	D93418	232	EKMULWCB	341
D931810060	225	D93304025	222	D93312090	222	D9331M06025	224	D93420	232	EM100	303
D931810070	225	D93304030	222	D93312100	222	D9331M06030	224	D93422	232	EM145	303
D931810080	225	D93304035	222	D93312110	222	D9331M06035	224	D93424	232	EM190	303
D931810090	225	D93304040	222	D93312120	222	D9331M06040	224	D93427	232	EMPTC45	140
D931810100	225	D93304045	222	D93314030	222	D9331M06050	224	D93430	232	EMPTC47	140
D931810110	225	D93304050	222	D93314035	222	D9331M08016	224	D93433	232	EMPTC60	140
D931810120	225	D93304060	222	D93314040	222	D9331M08020	224	D93436	232	EMPX4121	307
D931810130	225	D93305010	222	D93314045	222	D9331M08025	224	D9341M04	232	EMPS4115	310
D931810140	225	D93305012	222	D93314050	222	D9331M08030	224	D9341M05	232	EMX1302	306
D931810150	225	D93305016	222	D93314060	222	D9331M08035	224	D9341M06	232	EMX4502	306
D931812040	225	D93305020	222	D93314070	222	D9331M08040	224	D9341M08	232	EMX9002	306
D931812045	225	D93305025	222	D93314080	222	D9331M08050	224	D9341M10	232	EMX9004	306
D931812050	225	D93305030	222	D93314090	222	D9331M08060	224	D9341M12	232	EMZ00	303
D931812060	225	D93305035	222	D93314100	222	D9331M08070	224	D9341M14	232	EMZ45	303
D931812070	225	D93305040	222	D93314110	222	D9331M08080	224	D9341M16	232	EMZ90	303
D931812080	225	D93305045	222	D93314120	222	D9331M08090	224	D9341M18	232	EPS6072	75
D931812090	225	D93305050	222	D93316030	222	D9331M08100	224	D9341M20	232	EPS6092	75
D931812100	225	D93305060	222	D93316035	222	D9331M10020	224	D9341M22	232	EPS6112	75
D931812110	225	D93305070	222	D93316040	222	D9331M10025	224	D9341M24	232	EPS6132	75
D931812120	225	D93306010	222	D93316045	222	D9331M10030	224	D9851M04	233	EPS6152	75
D931812130	225	D93306012	222	D93316050	222	D9331M10035	224	D9851M05	233	EPS6182	75
D931812140	225	D93306016	222	D93316060	222	D9331M10040	224	D9851M06	233	EQ8808110	83
D931812150	225	D93306020	222	D93316070	222	D9331M10050	224	D9851M08	233	EQ8810130	83
D931814050	225	D93306025	222	D93316080	222	D9331M10060	224	D9851M10	233	EQ8812160	83
D931814060	225	D93306030	222	D93316090	222	D9331M10070	224	D9851M12	233	EQ8816190	83
D931814070	225	D93306035	222	D93316100	222	D9331M10080	224	D9851M14	233	EQ8820260	83
D931814080	225	D93306040	222	D93316110	222	D9331M10090	224	D9851M16	233	EQ8824300	83
D931814090	225	D93306045	222	D93316120	222	D9331M10100	224	D9851M18	233	EQA208110	83
D931814100	225	D93306050	222	D93318030	222	D9331M12020	224	D9851M20	233	EQA210130	83
D931814110	225	D93306060	222	D93318035	222	D9331M12030	224	D9851M22	233	EQA212160	83
D931814120	225	D93306065	222	D93318040	222	D9331M12040	224	D9851M24	233	EQA216190	83
D931814130	225	D93306070	222	D93318045	222	D9331M12050	224	DOMTA10	51	EQA220260	83
D931814140	225	D93308016	222	D93318050	222	D9331M12060	224	DOMTA20	51	EQA224300	83
D931814150	225	D93308020	222	D93318060	222	D9331M12070	224	DZ98503	233	EQA230330	83
D931816050	225	D93308025	222	D93318070	222	D9331M12080	224	DZ98504	233	EQA408110	83
D931816060	225	D93308030	222	D93318080	222	D9331M12090	224	DZ98505	233	EQA410130	83
D931816070	225	D93308035	222	D93318090	222	D9331M12100	224	DZ98506	233	EQA412160	83
D931816080	225	D93308040	222	D93318100	222	D9331M14030	224	DZ98508	233	EQA416190	83
D931816090	225	D93308045	222	D93318110	222	D9331M14040	224	DZ98510	233	EQA420260	83
D931816100	225	D93308050	222	D93318120	222	D9331M14050	224	DZ98512	233	EQA424300	83
D931816110	225	D93308060	222	D93320030	222	D9331M14060	224	DZ98514	233	EQA430330	83
D931816120	225	D93308070	222	D93320035	222	D9331M14070	224	DZ98516	233	EQAC08110	83
D931816130	225	D93308080	222	D93320040	222	D9331M14080	224	DZ98518	233	EQAC10130	83
D931816140	225	D93308090	222	D93320045	222	D9331M14100	224	DZ98520	233	EQAC10190	83
D931816150	225	D93308100	222	D93320050	222	D9331M16030	224	DZ98522	233	EQAC12160	83
D931818060	225	D93308110	222	D93320060	222	D9331M16040	224	DZ98524	233	EQAC12220	83
D931818070	225	D93308120	222	D93320070	222	D9331M16050	224	DZ98527	233	EQAC16190	83
D931818080	225	D93310016	222	D93320080	222	D9331M16060	224	DZ98530	233	EQAC16250	83
D931818090	225	D93310020	222	D93320090	222	D9331M16070	224	EKHUEFTL	343	EQAC20260	83
D931818100	225	D93310025	222	D93320100	222	D9331M16080	224	EKHUEFTL	343	EQAC20350	83
D931818110	225	D93310030	222	D93320110	222	D9331M16090	224	EKHUEFTP	342	EQAC24300	83
D931818120	225	D93310035	222	D93320120	222	D9331M16100	224	EKHUEILLU	342	EQAC24380	83
D931818130	225	D93310040	222	D9331M04010	224	D9331M18030	224	EKMFACTG	343	EQAC30330	83

Ref	pag	Ref	pag	Ref	pag	Ref	pag	Ref	pag		
ESDA208060	331	EVMA414	128	FPCL0827	145	GIA412	131	GRBL020	295	HEI665115	58
ESDA210060	331	EVMA416	128	FPCL0832	145	GIA414	131	GRBL030	295	HEI665125	58
ESDR06040	331	EVMA420	128	FPCL0838	145	GIA416	131	GRBL040	295	HEI665150	58
ESDR06050	331	EVMA424	128	FPCL0844	145	GIZ05	130	GRBL050	295	HEI665180	58
ESDR06060	331	EXHBM06	69	FPCL0851	145	GIZ06	130	GRBL060	295	HEI665200	58
ESDR06070	331	EXHBM08	69	FPCL0857	145	GIZ08	130	GRBL070	295	HE65032	58
ESDR06080	331	EXHBM08C	69	FPCL0864	145	GIZ10	130	GRBL080	295	HE65045	58
ESDR08050	331	EXHBM10	69	FPCL0870	145	GIZ11	130	GRBL090	295	HE65057	58
ESDR08060	331	EXHBM10C	69	FPCL2212	146	GIZ12	130	GRBL100	295	HE65070	58
ESDR08070	331	EXHBM12	69	FPCL2712	146	GIZ14	130	GRBL120	295	HE65080	58
ESDR08080	331	EXHBM12C	69	FPCL3212	146	GIZ16	130	GRBL140	295	HE65100	58
ESDR08090	331	EXHBM16	69	FPCL3712	146	GIZ20	130	GRNATTV	295	HE65115	58
ESDR08100	331	EXHBM20	69	FPCL4212	146	GIZ22	130	GRNE060	295	HE65125	58
ESDR08110	331	FG60BAT	151	FPCL4712	146	GIZ25	130	GRNE070	295	HE65150	58
ESDR08120	331	FG60CAR	151	FPCLD2212	147	GIZ28	130	GRNE080	295	HE65180	58
ESDR08130	331	FG60GAS	151	FPCLD2712	147	GIZ32	130	GRNE090	295	HE65200	58
ESDR10080	331	FG60GUN	148	FPCLD3212	147	GIZ36	130	GRNE100	295	HEA4M06	67
ESDR10100	331	FG60GUNEL	148	FPCLD3712	147	GLO351515	301	GRNE120	295	HEA4M08	67
ESDR10110	331	FGABRA15	150	FPCLD4212	147	GLO357510	301	GRZ05	129	HEA4M10	67
ESDR10120	331	FGABRA20	150	FPCLD4712	147	GMA030	310	GRZ06	129	HEA4M12	67
ESDR10130	331	FGABRA25	150	FPCR0812	146	GMA035	310	GRZ08	129	HEA4M16	67
ESDR10140	331	FGARAM25	149	FPCR0822	146	GMA040	310	GRZ10	129	HEA4M20	67
ESDR10150	331	FGARAM25EP	149	FPCR0827	146	GMZ08012	208	GRZ11	129	HEC4M06	67
ESDR10180	331	FGBASEGR	150	FPCR0827	146	GMZ10016	208	GRZ12	129	HEC4M08	67
ESDR10200	331	FGBASENE	150	FPCR0812	146	GMZ12020	208	GRZ14	129	HEC4M10	67
ESTRINV40N	196	FGCAEL	151	FPCR0827	146	GMZ15026	208	GRZ16	129	HEC4M12	67
ESTRINV40Z	196	FGCL15	149	FPCR0812	146	GMZ17030	208	GRZ18	129	HECLOM06	67
EVH06	128	FGCL20	149	FPCR0812	146	GMZ19035	208	GRZ20	129	HECLOM08	67
EVH08	128	FGCL25	149	FPP3VE	144	GPG271812	300	GRZ22	129	HECLOM10	67
EVH10	128	FGCL30	149	FPP4AM	144	GPG283018	300	GRZ25	129	HECLOM12	67
EVH12	128	FGCL35	149	FPP5RO	144	GPG351312	300	GRZ28	129	HECLOM12D	67
EVH14	128	FGCL40	149	FPP1081613	146	GPG384020	300	GRZ32	129	HECLOM16	67
EVH16	128	FGCLCAR40	151	FPPISCL08	147	GPG402015	300	GRZ36	129	HEHCM08	68
EVH18	128	FGCLH15	149	FPPISCL12	147	GPI271812	300	GRZ38	129	HEHCM10	68
EVH20	128	FGCLH17	149	FPPISCM12	147	GPI283015	300	GRZ42	129	HEHCM12	68
EVH22	128	FGCLH19	149	FPPISCT12	147	GPI384020	300	GRZ45	129	HEHCSDS08	68
EVH24	128	FGCLH22	149	FPPISPL08	147	GPO351515	301	GRZ50	129	HEHCSDS10	68
EVH27	128	FGCLH27	149	GAFOM06Z	329	GPO357510	301	GRZ56	129	HEHCSDS12	68
EVH30	128	FGCLH32	149	GAFOM08Z	329	GPP271812	300	GRZ63	129	HEHOM06	67
EVH36	128	FGIMAN	151	GAFOM10Z	329	GPV251120	300	GSTC040080	316	HEHOM08	67
EVH42	128	FGPLET	150	GAFOM12Z	329	GPVD4162012	311	GSTC080120	316	HEHOM10	67
EVH48	128	FI63110	160	GAFOM16Z	329	GPX2M412120	304	GSTU040055	316	HEHOM12	67
EVHA406	128	FI63115	160	GDA402	130	GPX2M414120	304	GSZ0325	131	HEHOM12D	67
EVHA408	128	FI63120	160	GDA403	130	GPX412115	304	GSZ0435	131	HEHOM16	67
EVHA410	128	FI63125	160	GDA404	130	GPX412120	304	GSZ0545	131	HEHOM20	67
EVHA412	128	FI63130	160	GDA405	130	GPX412125	304	GSZ0655	131	HEHOSDS06	68
EVHA414	128	FI63150	160	GDA406	130	GPX414115	304	GSZ0765	131	HEHOSDS08	68
EVHA416	128	FI63160	160	GDA408	130	GPX414120	304	GSZ0875	131	HEHOSDS10	68
EVHA420	128	FICAAB080	294	GDA410	130	GPX414125	304	GSZ1010	131	HEHOSDS12	68
EVHA424	128	FICAAB119	294	GDA412	130	GPXS4115012	310	HARM03026	206	HENOM06	68
EVM06	128	FICACL13	294	GDA415	130	GPXS4115125	310	HARM04035	206	HENOM08	68
EVM08	128	FICACL26	294	GDZ03	130	GPXS4115187	310	HARM05037	206	HENOM10	68
EVM10	128	FICAPD160	294	GDZ04	130	GPXS4115250	310	HARM06050	206	HENOM12	68
EVM12	128	FICAPS080	294	GDZ05	130	GPXS4115362	310	HARM08060	206	HENOM16	68
EVM14	128	FP08GUN	144	GDZ06	130	GPZ201010	300	HCM06	69	HENOM20	68
EVM16	128	FP12GUN	144	GDZ08	130	GPZ250808	300	HCM08	69	HENSM08	68
EVM18	128	FPAM0837	145	GDZ10	130	GRA404	129	HCM10	69	HENSM10	68
EVM20	128	FPAM0851	145	GDZ12	130	GRA405	129	HCRM03026	206	HENSM12	68
EVM22	128	FPAP085166	145	GDZ13	130	GRA406	129	HCRM04035	206	HENSM16	68
EVM24	128	FPC303708	145	GDZ15	130	GRA408	129	HCRM05037	206	HOCRM647	139
EVM27	128	FPC304708	145	GDZ18	130	GRA410	129	HCRM06050	206	HOCRM660	139
EVM30	128	FPCG0816	145	GDZ20	130	GRA412	129	HCRM08060	206	HOCUM647	139
EVM33	128	FPCG0819	145	GDZ24	130	GRA414	129	HCRM10065	206	HP75072	57
EVM36	128	FPCG1612	146	GESPM08ZE	329	GRA416	129	HCRM12075	206	HP75092	57
EVM42	128	FPCG1912	146	GESPM10ZE	329	GRA419	129	HEI665032	58	HP75112	57
EVM48	128	FPCGD1612	146	GIA404	131	GRA425	129	HEI665045	58	HP75132	57
EVMA406	128	FPCGD1912	146	GIA405	131	GRBL001	295	HEI665057	58	HP75152	57
EVMA408	128	FPCL0816	145	GIA406	131	GRBL002	295	HEI665070	58	HP75182	57
EVMA410	128	FPCL0819	145	GIA408	131	GRBL003	295	HEI665080	58	HPZ75072	57
EVMA412	128	FPCL0825	145	GIA410	131	GRBL010	295	HEI665100	58	HPZ75092	57

Ref	pag	Ref	pag	Ref	pag	Ref	pag	Ref	pag		
HPZ75112	57	IPACA08	105	LSABG6108	266	LSABPRG25	292	LSASF008016	271	LSPAGAM05	113
HPZ75132	57	IPAGN09	105	LSABG61022	266	LSABPU016	269	LSASF012022	271	LSPAGAM06	113
HPZ75152	57	IPAGN12	105	LSABG61028	266	LSABPU018	269	LSASF016027	271	LSTALAM06	69
HPZ75182	57	IPAGR09	105	LSABD6012	265	LSABPU020	269	LSASF020032	271	LSTALAM08	69
HPZ75212	57	IPAGR12	105	LSABD6015	265	LSABPU022	269	LSASF025040	271	LSTALAM10	69
HR75072	57	IPATO09	105	LSABD6018	265	LSABPU025	269	LSASF030045	271	LSTCCA05025	99
HR75092	57	IPATO12	105	LSABD6022	265	LSABPU028	269	LSASF035050	271	LSTCCA05030	99
HR75112	57	KCGPD0130	320	LSABD6028	265	LSABPU032	269	LSASF040060	271	LSTCCA05035	99
HR75132	57	KCGPD0135	320	LSABDI0012	266	LSABPU037	269	LSASF050070	271	LSTCCA05050	99
INCO421	114	KCGPD0140	320	LSABDI0015	266	LSABPU040	269	LSBAESM04	112	LSTCCA06035	99
INCO432	114	KCGPD01AM	320	LSABDI0018	266	LSABPU050	269	LSBAESM05	112	LSTCCA06040	99
INCO438	114	KCGPX0230	319	LSABDI0022	266	LSABPU063	269	LSBAESM06	112	LSTCCA06050	99
INCO446	114	KCGPX0235	319	LSABGAT022	256	LSABRETO22	250	LSBAGAM04	112	LSTCCA06060	99
INCO459	114	KCGPX0240	319	LSABGAT028	256	LSABRETO28	250	LSBAGAM05	112	LSTCCA06070	99
INCO537	114	KCGPX02AM	319	LSABGAT035	256	LSABRETO35	250	LSBAGAM06	112	LSTCCA08060	99
INCO552	114	KCGPX0330	319	LSABGAT040	256	LSABRETO40	250	LSCABA004	112	LSTCCA08080	99
INCO565	114	KCGPX0335	319	LSABGAT048	256	LSABRETO48	250	LSCABA005	112	LSTCCC05025	98
INCO580	114	KCGPX0340	319	LSABGAT060	256	LSABRETO60	250	LSCABA006	112	LSTCCC05030	98
INCO637	114	KCGPX03AM	319	LSABGAT075	256	LSABRETO75	250	LSCAPA004	113	LSTCCC05035	98
INCO652	114	KCP2SA0230	319	LSABGAT090	256	LSABRETO90	250	LSCAPA005	113	LSTCCC05050	98
INCO665	114	KCP2SA0235	319	LSABGAT110	256	LSABRETT10	250	LSCAPA006	113	LSTCCC06035	98
INCO680	114	KCP2SA0240	319	LSABGS015	275	LSABRETT25	250	LSESDR06080	331	LSTCCC06040	98
INHE837	114	KCP2SA02AM	319	LSABGS018	275	LSABRIT022	252	LSESDR08060	331	LSTCCC06050	98
INHE855	114	KCP2SA0330	319	LSABGS022	275	LSABRIT028	252	LSESDR08080	331	LSTCCC06060	98
INHE865	114	KCP2SA0335	319	LSABGUG15	291	LSABRIT035	252	LSESDR08100	331	LSTCCC06070	98
INPINZANI	115	KCP2SA0340	319	LSABGUG18	291	LSABRIT040	252	LSESDR08120	331	LSTCCC08060	98
INPISANIN	115	KCP2SA03AM	319	LSABGUG20	291	LSABRIT048	252	LSESDR10080	331	LSTCCC08080	98
INSI421	114	KCP2SC0230	319	LSABGUG22	291	LSABRIT060	252	LSESDR10100	331	LSTNXA08080	95
INSI432	114	KCP2SC0235	319	LSABGUG25	291	LSABRIT075	252	LSESDR10120	331	LSTNXA08100	95
INSI438	114	KCP2SC0240	319	LSABGUG28	291	LSABRIT090	252	LSHENOM06	68	LSTNXA08120	95
INSI537	114	KCP2SC02AM	319	LSABGUG32	291	LSABRIT110	252	LSHENOM08	68	LSTNXA10080	95
INSI552	114	KCP2SC0330	319	LSABGUG40	291	LSABTA0630	329	LSHENOM10	68	LSTNXA10100	95
INSI565	114	KCP2SC0335	319	LSABGUG50	291	LSABTA0640	329	LSHP75072	57	LSTNXE08080	95
INSI637	114	KCP2SC0340	319	LSABID012	290	LSABTA0650	329	LSHP75092	57	LSTNXE08100	95
INSI652	114	KCP2SC03AM	319	LSABID014	290	LSABTA0840	329	LSHP75112	57	LSTNXE08120	95
INSI665	114	KCP2SD0130	319	LSABID016	290	LSABTA0860	329	LSHP75132	57	LSTNXE10080	95
INSI865	114	KCP2SD0135	319	LSABID020	290	LSABTAB0630	329	LSINCO432	114	LSTNXE10100	95
INVA27050	196	KCP2SD0140	319	LSABID028	290	LSABTAB0640	329	LSINCO438	114	LSVRSE06030	327
INVA27060	196	KCP2SD01AM	319	LSABIN012	290	LSABTAB0650	329	LSINCO446	114	MABM6018	139
INVA27070	196	KFRSC3050	310	LSABIN014	290	LSABTD018	293	LSINCO537	114	MAE0620	327
INVA27080	196	KFSAU10160	315	LSABIN016	290	LSABTD022	293	LSINCO552	114	MAE0630	327
INVN6040	196	KFSAU10200	315	LSABIN020	290	LSABTS018	293	LSINCO637	114	MAE0825	327
INVN6050	196	KFSFIM08	312	LSABIN028	290	LSABTS022	293	LSINCO652	114	MAEI030	327
INVN6060	196	KFSFLM08	312	LSABM6012	264	LSACHA08C	65	LSMAE0630	327	MAEI235	327
INVN6070	196	KFSMAI0200	315	LSABM6014	264	LSACHA10C	65	LSMAE0825	327	MAEI650	327
INVN7030	196	KFSMAI0250	315	LSABM6016	264	LSACHG08C	64	LSMAEI030	327	MAE2060	327
INVN7040	196	KFSMAI2300	315	LSABM6018	264	LSACHG10C	64	LSMAR0420	328	MAMH0610	328
INVN7050	196	KFSMAI2350	315	LSABM6022	264	LSACHT08C	61	LSMAR0630	328	MAMH0620	328
INVN7060	196	KFSRV10250	315	LSABM6028	264	LSACHT08L	61	LSMAR0830	328	MAMH0630	328
INVN7070	196	KFSRV12350	315	LSABM6032	264	LSACHT10C	61	LSMARI030	328	MAMH0640	328
INVN7080	196	KITINPIN01	115	LSABM6040	264	LSACHT10L	61	LSMIO8075	48	MAMH0650	328
INVN7090	196	KTGPX0230	320	LSABM8090	256	LSACHT12C	61	LSMIO8090	48	MAR0420	328
INVZ6040	195	KTGPX0235	320	LSABM8110	256	LSACHT12L	61	LSMII0070	48	MAR0620	328
INVZ6050	195	KTGPX0240	320	LSABM8125	256	LSACHT16C	61	LSMII0090	48	MAR0630	328
INVZ6060	195	KTGPX02AM	320	LSABM8160	256	LSACHTA208C	61	LSMII0120	48	MAR0825	328
INVZ6070	195	KTGPX0330	320	LSABMUG15	291	LSACHTA208L	61	LSMII2110	48	MAR0830	328
INVZ7030	195	KTGPX0335	320	LSABMUG18	291	LSACHTA210C	61	LSMIA408075	48	MAR1030	328
INVZ7040	195	KTGPX0340	320	LSABMUG22	291	LSACHTA210L	61	LSMIA410090	48	MARI235	328
INVZ7050	195	KTGPX03AM	320	LSABMUG26	291	LSACHTA212C	61	LSMIA412110	48	MARI650	328
INVZ7060	195	KTPSE0230	320	LSABMUG32	291	LSACHTA212L	61	LSMOES06070	82	MAR5322	328
INVZ7070	195	KTPSE0235	320	LSABPI016	269	LSAH06060	46	LSMOES08110	82	MARI0830	328
INVZ7080	195	KTPSE0240	320	LSABPI018	269	LSAH08060	46	LSMOES10115	82	MARI1030	328
INVZ7090	195	KTPSE02AM	320	LSABPI020	269	LSAH08075	46	LSMOES12110	82	MEDUB06	102
INVZ7105	195	KTPSE0330	320	LSABPI022	269	LSAH08090	46	LSMOTN12050	82	MEDUB07	102
INVZ7120	195	KTPSE0335	320	LSABPI025	269	LSAH10070	46	LSMOTN15085	82	MEDUB08	102
INVZ7140	195	KTPSE0340	320	LSABPI028	269	LSAH10090	46	LSMOTN20085	82	MEDUB10	102
INVZ7165	195	KTPSE03AM	320	LSABPI032	269	LSAH10120	46	LSPAESM04	113	MI06045	48
INVZ7205	195	LSAB61012	266	LSABPI040	269	LSAH12090	46	LSPAESM05	113	MI06060	48
IPAAR09	105	LSAB61015	266	LSABPRG15	292	LSAH12110	46	LSPAESM06	113	MI06080	48
IPAAR12	105	LSAB61016	266	LSABPRG20	292	LSAH16125	46	LSPAGAM04	113	MI06120	48

Ref	pag	Ref	pag	Ref	pag	Ref	pag	Ref	pag	Ref	pag
MI06140	48	MOPISPUR6	82	NBP4838	168	P70TPNG	177	PLCAZ4216	137	PTBRI0035	218
MI06160	48	MOPISSI	82	NBP4850	168	P903510	178	PLCAZ4219	137	PTBRI3355	218
MI06170	48	MOPISTO	82	NBR3509	165	P904017	178	PLCAZ4225	137	PTM18040	218
MI06180	48	MOPS300	79	NBR3513	165	PACC15015	207	PLCAZ4232	137	PTET169845	218
MI08050	48	MOPS300EP	79	NBR3516	165	PACC15020	207	PLCAZ4241	137	PTOB05015	218
MI08075	48	MOPS410	79	NBR3519	165	PACCI5025	207	PLCAZ4251	137	PTOB06015	218
MI08090	48	MOPSP300	79	NBR4213	165	PACC20025	207	PLEP35025	136	PTOB08015	218
MI08115	48	MOPSP410	79	NBR4216	165	PACC20030	207	PLEP35035	136	PTOBI0015	218
MI10070	48	MOPU300	79	NBR4219	165	PACC20035	207	PLRA3925	137	PTOBI2020	218
MI10090	48	MOPU410	79	NBR4225	165	PACC20040	207	PLRA3935	137	PTTT030716	218
MI10120	48	MOPUR30385	81	NBR4232	165	PACC20045	207	PLRA3945	137	PTTT111430	218
MI10150	48	MOPUR30585	81	NBR4238	165	PACC20050	207	PLRA3955	137	PTUN12038	218
MI12075	48	MOPURE600	81	NBR4816	165	PACCP22520	207	PLRA4835	137	PTUN16038	218
MI12090	48	MORCANU	82	NBR4819	165	PACCP22525	207	PLTR3525	137	PTUN20060	218
MI12110	48	MORCAPU	82	NBR4825	165	PACCP22530	207	PLTR3535	137	PTUN20080	218
MI12140	48	MORCEPKIT	82	NBR4832	165	PACCP25040	207	PLTR3545	137	PTUN24060	218
MI16090	48	MOTL16330	82	NBR4838	165	PACPP25050	207	PMO1012	316	PTUN24080	218
MI16145	48	MOTM12100	82	NBR4845	165	PACP29050	207	PMOL1012	316	PUCA01	92
MI16170	48	MOTM16100	82	NBR4850	165	PACP29060	207	PRX01	305	PUCL500	91
MI20120	48	MOTM22100	82	NUXSM0841	314	PACP29070	207	PSI655060	159	PUCUC01	241
MI20170	48	MOTN12050	82	OMEM06	139	PACP34030	207	PSI655082	159	PUCUC02	241
MI20220	48	MOTN12080	82	PI00KOMIO	178	PACP34040	207	PSI655098	159	PUCUC03	241
MIA406045	48	MOTN15085	82	PI00VEK	178	PACP34050	207	PSI655115	159	PUCUL01	241
MIA406060	48	MOTN15130	82	PI00VEK10	178	PACP34060	207	PSI955195	160	PUCUL02	241
MIA406080	48	MOTN20085	82	PI00VEK13	178	PACP34070	207	PSI955230	160	PUCUL03	241
MIA408050	48	MOTRO08	82	PI03925Z	176	PACP34080	207	P555060	159	PUEP750	91
MIA408075	48	MOTRO10	82	PI03930Z	176	PAESM04	113	P555082	159	PUF750	91
MIA408090	48	MOTRO12	82	PI03938Z	176	PAESM05	113	P555098	159	PUFP750	90
MIA408115	48	MOV300	80	PI03945Z	176	PAESM06	113	P555115	159	PUOXBITC10	241
MIA410070	48	MOV410	80	P204316Z	176	PAESM08	113	P555130	159	PUOXBITC15	241
MIA410090	48	MOV5300	80	P204319Z	176	PAEXM08	254	P555150	159	PUOXBITC20	241
MIA410120	48	MOV5410	80	P204322Z	176	PAEXM10	254	P555180	159	PUOXBITC25	241
MIA410150	48	MQB04	131	P204325	176	PAGAM04	113	P555200	159	PUOXBITC30	241
MIA412075	48	MQB05	131	P204325Z	176	PAGAM05	113	P555230	159	PUOXBITC40	241
MIA412090	48	MQB06	131	P204330	176	PAGAM06	113	PSAA0400	311	PUOXBITL10	241
MIA412110	48	MQB07	131	P204330Z	176	PAGAM08	113	PSAA1250	311	PUOXBITL15	241
MIA412140	48	MQB08	131	P204338	176	PCU0005	140	PSAA1875	311	PUOXBITL20	241
MIA416090	48	MQB09	131	P204338Z	176	PCU0006	140	PSAA2500	311	PUOXBITL25	241
MIA416145	48	MQB10	131	P204345	176	PFA4M0800	332	PSAA3625	311	PUOXBITL30	241
MIA416170	48	MQB11	131	P204345Z	176	PFA4M0810	332	PSAAV0150	311	PUOXBITL40	241
MIA420120	48	MQB12	131	P204355	176	PFA4M1000	332	PSAUN200	311	PUPHC01	240
MIA420170	48	MQB14	131	P204355Z	176	PFZNM0800	332	PSEA601250	311	PUPHC02	240
MIA420220	48	MQB15	131	P304825	176	PFZNM0810	332	PSEA601875	311	PUPHC03	240
MLMULT01	211	MQBS04	131	P304838	176	PFZNM1000	332	PSEA602500	311	PUPHL01	240
MLMULT201	211	MQBS06	131	P403913Z	177	PCI2718	303	PSEA603625	311	PUPHL02	240
MLMULT301	211	MQBS07	131	P403916	176	PCI2830	303	PSEC410125	312	PUPHL03	240
MLPLAT01	211	MQBS08	131	P403916Z	177	PCI3840	303	PSEC410200	312	PUPI01	92
MLPLAT201	211	MQBS09	131	P403919	176	PGSA26	310	PSEC411250	312	PUPI02	92
MLPLAT301	211	MQBS10	131	P403919Z	177	PGX4121	308	PSEC411875	312	PUPM014	242
MLTBOP101	210	MQBS11	131	P403925	176	PGX4141	308	PSEC412500	312	PUPOC01	241
MLTPPOP101	210	MQBS12	131	P403925Z	177	PGZ2718	303	PSEC413625	312	PUPOC02	241
MLTPPOT101	211	MSCAHT	88	P403932	176	PGZ2830	303	PSECUN200	312	PUPOC03	241
MLTPPOT201	211	MSCATP	88	P403932Z	177	PGZ3840	303	PSEUN060200	312	PUPOL01	241
MLTPPOT301	211	MSPRB290	85	P403938	176	PL35019	136	PSL1655075	160	PUPOL02	241
MOBOMBA	82	MSPRC290	85	P403938Z	177	PL35025	136	PSL1655085	160	PUPOL03	241
MOES06070	82	MSPRM290	85	P50M413Z	177	PL35035	136	PSL1655105	160	PUSC750	89
MOES08110	82	MSPRN290	85	P50M416	177	PL35045	136	PSL1655130	160	PUSP750	89
MOES10115	82	MSSF290	85	P50M416Z	177	PL35055	136	PSL1655150	160	PUTC750	90
MOES12110	82	MSTR290	85	P50M419	177	PL39025	136	PSL1955255	160	PUTO010	240
MOH300	80	NBP3513	168	P50M419Z	177	PL39035	136	PSL1955285	160	PUTO015	240
MOH410	80	NBP3516	168	P50M425	177	PL39045	136	PSL55075	160	PUTO020	240
MOHW300	80	NBP3519	168	P50M425Z	177	PL39055	136	PSL55085	160	PUTO025	240
MOHW410	80	NBP3525	168	P50M432	177	PL42070	136	PSL55105	160	PUTO030	240
MOP300	79	NBP4216	168	P50M432Z	177	PL42080	136	PSL55130	160	PUTO040	240
MOP410	79	NBP4219	168	P50M438	177	PL48090	136	PSL55150	160	PUTP750	89
MOPC185	82	NBP4225	168	P704855	177	PL48100	136	PSL55175	160	PUTPR750	90
MOPISNEU	82	NBP4232	168	P704865	177	PL48110	136	PSL55200	160	PUZ2718	303
MOPISP3385	82	NBP4238	168	P704880	177	PL48120	136	PSL55230	160	PUZ3840	303
MOPISP3585	82	NBP4825	168	P704895	177	PL48130	136	PSL55240	160	RAFEM145	335
MOPISPR	82	NBP4832	168	P70TPBL	177	PLCAZ4213	137	PSL55280	160	RAFEM175	335

Ref	pag	Ref	pag	Ref	pag	Ref	pag	Ref	pag	Ref	pag
RAFIN00	334	RENO4016	118	SATEB0860	337	SIPRM280	87	SLPT10070	59	SUAB0607	323
RAFRE095	334	RENO4018	118	SATEB1080	337	SIPRN280	87	SLPT10080	59	SUAB0614	323
RAPE5032	335	RENO4020	118	SAWH06070	337	SIPRSB280	87	SLPT10100	59	SUCA0602	323
RARAY032	335	RENO4025	118	SAWHM06060	337	SIPRST280	87	SLPT10110	59	SUCA0604	323
RAROI00	335	RENO4030	118	SAWL05080	336	SIPRT280	87	SLPT12080	59	SUCA0607	323
RATRG095	334	RENO4035	118	SAWZ05080	336	SIUNIB280	87	SLPT12090	59	SUCA0802	323
RATRI095	334	RENO4806	118	SCAS3317DR	215	SIUNIG280	87	SLPT12100	59	SUCA0804	323
RECA4008	119	RENO4808	118	SCAS3317IZ	215	SIUNIM280	87	SLPT12120	59	SUCA0807	323
RECA4010	119	RENO4810	118	SCCDZ402575	216	SIUNIT280	87	SLPT16100	59	SUCA1002	323
RECA4012	119	RENO4810BL	119	SCCE200404	215	SIUNSB280	88	SLPT16120	59	SUCA1004	323
RECA4016	119	RENO4810NE	120	SCCI303030	216	SIUNST280	88	SLPT16140	59	SUCA1007	323
RECA4810	119	RENO4812	118	SCCI404040	216	SJA42103	124	SLPT16160	59	SUCA1202	323
RECA4812	119	RENO4812BL	119	SCCI606060	216	SJA42305	124	SLPT18110	59	SUCA1204	323
RECA4814	119	RENO4812NE	120	SCED050503	214	SJA42606	124	SLPT18120	59	SUCA1207	323
RECA4816	119	RENO4814	118	SCED060604	214	SJA43008	124	SLPT18140	59	SUCA1502	323
RECA4818	119	RENO4814BL	119	SCED070705	214	SJA43410	124	SLPT18150	59	SUCA1504	323
REFL4012	120	RENO4814NE	120	SCED090904	214	SJA43611	124	SLPT18170	59	SUCA1507	323
REFL4014	120	RENO4816	118	SCED090906	214	SJA44444	124	SLPT18200	59	SUCA1902	323
REFL4016	120	RENO4816BL	119	SCEDI01009	214	SJA45016	124	SLPT24140	59	SUCA1904	323
REFL4018	120	RENO4816NE	120	SCEI040402	214	SJA45418	124	SLPT24170	59	SUCA1907	323
REFL4020	120	RENO4818	118	SCEI040404	214	SJA46122	124	SLPT24200	59	SUCA2502	323
REFL4025	120	RENO4820	118	SCEI040406	214	SJA46525	124	SLPT24220	59	SUCA2504	323
REFL4814	120	RENO4822	118	SCEI050504	214	SJO0502	124	SLPT28170	59	SUCA2507	323
REFL4816	120	RENO4824	118	SCEI060604	214	SJO0503	124	SLPT28200	59	SUCL02	322
REFL4818	120	RENO4826	118	SCEI060606	214	SJO0604	124	SLPT28240	59	SUCL04	322
REFL4824	120	RENO4828	118	SCEI060608	214	SJO0605	124	SOPG27	308	SUCL10	322
REFL4830	120	RENO4830	118	SCEI070704	214	SJO0606	124	SOPG38	308	SUCL15	322
REFL4835	120	RENO4835	118	SCEI080808	214	SJPD0402	125	SOPG41	308	SUCU0602	323
REFL4840	120	RENO6008	118	SCEI101004	214	SJPD0403	125	SOTP2718	304	SUCU0605	323
REFL4845	120	RENO6010	118	SCEI101010	214	SJPD0504	125	SOTP2830	304	SUCU0606	323
REFL4850	120	RENO6012	118	SCEM081240	216	SJPD0605	125	SOTP3840	304	SUCU0607	323
REIN3206	119	RENO6016	118	SCEM101640	216	SJPD0606	125	SOTP4121	304	SUMOM06	322
REIN3208	119	RENO6018	118	SCER302525	217	SJPD0808	125	SOTP4141	304	SUMOM08	322
REIN3212	119	RENO6025	118	SCER392822	217	SJPDA40403	125	SOUO04110	214	SUMOM10	322
REIN3215	119	RESX300	305	SCGA100404	215	SJPDA40504	125	SOUO06100	214	SUMOM12	322
REIN4008	119	RESX550	305	SCGEZ704025	217	SJPDA40605	125	SOUO07125	214	SUMOP09	322
REIN4010	119	RETE5220	318	SCLCZ354030	217	SJPDA40606	125	SOUO08120	214	SUMOP11	322
REIN4012	119	RMEX01	122	SCLD040606	214	SJPS0402	125	SOUO10140	214	SUMOP13	322
REIN4016	119	RMMA01	122	SCLD060806	214	SJPS0403	125	SOUR30140DR	214	SUSTC47090	141
REIN4810	119	RMPA01	122	SCMX020214	217	SJPS0504	125	SOUR30140IZ	214	SUSTC47180	141
REIN4812	119	RSA23509	169	SCMX030314	217	SJPS0605	125	SPGH2718	302	SUSTC47240	141
REIN4816	119	RSA24213	169	SCMX040415	217	SJPS0606	125	SPGH3840	302	SUSTC47300	141
REIN4818	119	RSA24216	169	SCMX050515	217	SJPSA40403	125	SPH2718	302	SUSTC47400	141
REIN4820	119	RSA24219	169	SCMX060618	217	SJPSA40504	125	SPH3840	302	SUVA0602	322
RENO3206	118	RSA24816	169	SCMX070718	217	SJPSA40605	125	SPRXH4121	304	SUVA0604	322
RENO3208	118	RSA24819	169	SCOB020214	216	SJPSA40606	125	SPRXV4121	304	SUVA0610	322
RENO3208BL	119	RSA24825	169	SCOB030314	216	SJZ0403	124	SPUX412100	305	SUVA0615	322
RENO3208NE	120	RSZ3509	169	SCOB040415	216	SJZ0505	124	SPUX412145	305	SUVA0802	322
RENO3210	118	RSZ3513	169	SCOB050515	216	SJZ0506	124	SPV2718	301	SUVA0804	322
RENO3210BL	119	RSZ3516	169	SCOB060618	216	SJZ0608	124	SPV3840	301	SUVA0810	322
RENO3210NE	120	RSZ4213	169	SCOB070718	216	SJZ0810	124	SPX412115	304	SUVA0815	322
RENO3212	118	RSZ4216	169	SCOB090920	216	SJZ0811	124	SPX412130	304	SVCBL	209
RENO3212BL	119	RSZ4219	169	SCOB101020	216	SJZ1013	124	SPX412145	304	SVCMA	209
RENO3212NE	120	RSZ4225	169	SCOB121222	216	SJZ1014	124	SPX414110	304	SVNB01	209
RENO3214	118	RSZ4232	169	SCOZ151525	216	SJZ1216	124	SPX414115	304	SVNB02	209
RENO3216	118	RSZ4813	169	SCPD107530	217	SJZ1220	124	SPX414130	304	SVNM01	209
RENO3218	118	RSZ4816	169	SCPD128035	217	SJZ1422	124	SPX414145	304	SVNM02	209
RENO4006	118	RSZ4819	169	SCREZ357565	217	SJZ1426	124	SPX414160	304	T0840304Z	229
RENO4008	118	RSZ4825	169	SCRFO70605	215	SJZ1630	124	SPX414175	304	T0840306Z	229
RENO4008BL	119	RSZ4832	169	SCRFO70705	215	SJZ1634	124	SPZ271820	301	T0840308Z	229
RENO4008NE	120	RSZ4838	169	SCRFO90906	215	SJZ1640	124	SPZ271830	301	T0840310Z	229
RENO4010	118	RTX01	307	SCRFI01009	215	SJZ1845	124	SPZ384020	301	T0840312Z	229
RENO4010BL	119	SACI06080	337	SCRFI15106	215	SJZ2050	124	SPZ384025	301	T0840316Z	229
RENO4010NE	120	SAIL06080	336	SCRGO90505	215	SLPC10070	59	SPZ384030	301	T0840320Z	229
RENO4012	118	SALH08100	336	SCRGO90508	215	SLPC10080	59	SPZ384035	301	T0840325Z	229
RENO4012BL	119	SALH10120	336	SCRX090	307	SLPC10100	59	SPZ384040	301	T0840330Z	229
RENO4012NE	120	SALN08100	336	SEACRB280	88	SLPC12100	59	SPZ384050	301	T0840335Z	229
RENO4014	118	SALN10120	336	SEACRG280	88	SLPC16100	59	SPZ384060	301	T0840340Z	229
RENO4014BL	119	SATFA0865	337	SIPRB280	87	SLPC16120	59	STR1680	316	T0840406Z	229
RENO4014NE	120	SATEA1075	337	SIPRG280	87	SLPC18120	59	SUAB0603	323	T0840408Z	229

Ref	pag	Ref	pag	Ref	pag	Ref	pag	Ref	pag	Ref	pag
T0840410Z	229	T8142070	172	T8239016	173	T9630640Z	231	T9850550Z	230	TB05050	194
T0840412Z	229	T8142080	172	T8239019	173	T9630650Z	231	T9850608Z	230	TB05060	194
T0840416Z	229	T8142090	172	T8239022	173	T9630660Z	231	T9850610Z	230	TB06025	194
T0840420Z	229	T814213BLE	171	T8239025	173	T9650306Z	231	T9850612Z	230	TB06030	194
T0840425Z	229	T814225BLE	171	T8239032	173	T9650308Z	231	T9850616Z	230	TB06035	194
T0840435Z	229	T8148009	172	T8239038	173	T9650310Z	231	T9850620Z	230	TB06040	194
T0840445Z	229	T8148013	172	T8239045	173	T9650312Z	231	T9850625Z	230	TB06045	194
T0840450Z	229	T8148016	172	T8239050	173	T9650316Z	231	T9850630Z	230	TB06050	194
T0840460Z	229	T8148019	172	T8242013	173	T9650320Z	231	T9850635Z	230	TB06060	194
T0840470Z	229	T8148022	172	T8242016	173	T9650325Z	231	T9850640Z	230	TB06070	194
T0840506Z	229	T8148025	172	T8242019	173	T9650408Z	231	T9850650Z	230	TB06080	194
T0840508Z	229	T8148032	172	T8242022	173	T9650410Z	231	T9850660Z	230	TB06090	194
T0840510Z	229	T8148038	172	T8242025	173	T9650412Z	231	TACB166025	317	TB06100	194
T0840512Z	229	T8148045	172	T8242032	173	T9650416Z	231	TACN165525	317	TB06110	194
T0840516Z	229	T8148050	172	T8242038	173	T9650420Z	231	TACOB166025	289	TB06120	194
T0840520Z	229	T8148060	172	T8242045	173	T9650425Z	231	TACOB166025	289	TB07030	194
T0840525Z	229	T8148070	172	T8242050	173	T9650430Z	231	TACOB166025	289	TB07040	194
T0840530Z	229	T8148080	172	T8242060	173	T9650435Z	231	TACOB166025	289	TB07050	194
T0840535Z	229	T8148090	172	T8242070	173	T9650440Z	231	TACOB166025	289	TB07060	194
T0840540Z	229	T8148100	172	T8248013	173	T9650450Z	231	TACOL05	104	TB07070	194
T0840545Z	229	T8148110	172	T8248016	173	T9650510Z	231	TACOL06	104	TB07080	194
T0840550Z	229	T8148120	172	T8248019	173	T9650512Z	231	TACOL08	104	TB07090	194
T0840560Z	229	T8155013	172	T8248022	173	T9650516Z	231	TACOL10	104	TB07100	194
T0840608Z	229	T8155016	172	T8248025	173	T9650520Z	231	TACOL12	104	TB07120	194
T0840610Z	229	T8155019	172	T8248032	173	T9650525Z	231	TACOLA06	104	TB08030	194
T0840616Z	229	T8155022	172	T8248038	173	T9650530Z	231	TACON04	104	TB08040	194
T0840620Z	229	T8155025	172	T8248045	173	T9650535Z	231	TACON05	104	TB08045	194
T0840625Z	229	T8155032	172	T8248050	173	T9650540Z	231	TACON06	104	TB08050	194
T0840630Z	229	T8155038	172	T8248060	173	T9650550Z	231	TACON07	104	TB08060	194
T0840635Z	229	T8155045	172	T8248070	173	T9650560Z	231	TACON08	104	TB08070	194
T0840640Z	229	T8155050	172	T8255013	173	T9650610Z	231	TACON10	104	TB08080	194
T0840645Z	229	T8155060	172	T8255016	173	T9650612Z	231	TACON12	104	TB08090	194
T0840650Z	229	T8155070	172	T8255019	173	T9650616Z	231	TACON14	104	TB08100	194
T0840660Z	229	T8155080	172	T8255022	173	T9650620Z	231	TACON16	104	TB08110	194
T8129006	172	T8155090	172	T8255025	173	T9650625Z	231	TACOP05	105	TB08120	194
T8129009	172	T8155100	172	T8255032	173	T9650630Z	231	TACOP06	105	TB08130	194
T8129013	172	T8155110	172	T8255038	173	T9650635Z	231	TACOP07	105	TB08140	194
T8129016	172	T8155120	172	T8255045	173	T9650640Z	231	TACOP08	105	TB08150	194
T8129019	172	T8163016	172	T8255050	173	T9650650Z	231	TACOP09	105	TB08160	194
T8129022	172	T8163019	172	T8255060	173	T9650660Z	231	TACOP10	105	TB08180	194
T8129025	172	T8163022	172	T8255070	173	T9850306Z	230	TACOP11	105	TB08200	194
T8135006	172	T8163025	172	T8263025	173	T9850308Z	230	TACOP12	105	TB10040	194
T8135009	172	T8163032	172	T8263032	173	T9850310Z	230	TACOP14	105	TB10050	194
T8135013	172	T8163038	172	T8263038	173	T9850312Z	230	TAEN4213	171	TB10060	194
T8135016	172	T8163045	172	T8263045	173	T9850316Z	230	TAEN4216	171	TB10070	194
T8135019	172	T8163050	172	T8263050	173	T9850320Z	230	TAEN4219	171	TB10080	194
T8135025	172	T8163060	172	T8263060	173	T9850325Z	230	TAEN4225	171	TB10090	194
T8135032	172	T8163070	172	T8263070	173	T9850330Z	230	TAEN4232	171	TB10100	194
T813509BLE	171	T8163080	172	T9630410Z	231	T9850406Z	230	TAEZ4213	171	TB10110	194
T8139009	172	T8163090	172	T9630412Z	231	T9850408Z	230	TAEZ4216	171	TB10120	194
T8139013	172	T8163100	172	T9630416Z	231	T9850410Z	230	TAEZ4219	171	TB10130	194
T8139016	172	T8163110	172	T9630420Z	231	T9850412Z	230	TAEZ4225	171	TB10140	194
T8139019	172	T8163120	172	T9630430Z	231	T9850416Z	230	TAEZ4232	171	TB10150	194
T8139022	172	T8229006	173	T9630440Z	231	T9850420Z	230	TALA532	69	TB10160	194
T8139025	172	T8229009	173	T9630450Z	231	T9850425Z	230	TALAM04	69	TB10180	194
T8139032	172	T8229013	173	T9630510Z	231	T9850430Z	230	TALAM05	69	TB10200	194
T8139038	172	T8229016	173	T9630512Z	231	T9850435Z	230	TALAM06	69	TB12060	194
T8139045	172	T8229019	173	T9630516Z	231	T9850440Z	230	TALAM08	69	TB12070	194
T8139050	172	T8229022	173	T9630520Z	231	T9850450Z	230	TALAM10	69	TB12080	194
T8142009	172	T8229025	173	T9630525Z	231	T9850506Z	230	TALAM12	69	TB12090	194
T8142013	172	T8235009	173	T9630530Z	231	T9850508Z	230	TAME05030	70	TB12100	194
T8142016	172	T8235013	173	T9630540Z	231	T9850510Z	230	TAME06032	70	TB12120	194
T8142019	172	T8235016	173	T9630550Z	231	T9850512Z	230	TAME08038	70	TB12130	194
T8142022	172	T8235019	173	T9630560Z	231	T9850516Z	230	TAME08060	70	TB12140	194
T8142025	172	T8235022	173	T9630610Z	231	T9850520Z	230	TAME10060	70	TB12150	194
T8142032	172	T8235025	173	T9630612Z	231	T9850525Z	230	TAPLAME	116	TB12160	194
T8142038	172	T8235032	173	T9630616Z	231	T9850530Z	230	TAPLANK	116	TB12180	194
T8142045	172	T8235038	173	T9630620Z	231	T9850535Z	230	TAPLAZYK	116	TB12200	194
T8142050	172	T8239009	173	T9630625Z	231	T9850540Z	230	TB05030	194	TB12220	194
T8142060	172	T8239013	173	T9630630Z	231	T9850545Z	230	TB05040	194	TB12240	194

Ref	pag	Ref	pag	Ref	pag	Ref	pag	Ref	pag		
TBI2260	194	TCCC05025	98	TECBT80120	185	TEXBP45060	180	TEXBT50030	182	TEXZP35030	181
TBI4100	194	TCCC05030	98	TECBT80140	185	TEXBP45070	180	TEXBT50035	182	TEXZP35035	181
TBA206040	195	TCCC05035	98	TECBT80160	185	TEXBP45080	180	TEXBT50040	182	TEXZP35040	181
TBA206050	195	TCCC05050	98	TECBT80180	185	TEXBP50025	180	TEXBT50045	182	TEXZP35045	181
TBA206060	195	TCCC06035	98	TECBT80200	185	TEXBP50030	180	TEXBT50050	182	TEXZP35050	181
TBA206070	195	TCCC06040	98	TECBT80220	185	TEXBP50035	180	TEXBT50060	182	TEXZP40012	181
TBA208050	195	TCCC06050	98	TECBT80240	185	TEXBP50040	180	TEXBT50070	182	TEXZP40015	181
TBA208060	195	TCCC06060	98	TECBT80260	185	TEXBP50045	180	TEXBT50080	182	TEXZP40016	181
TBA208070	195	TCCC06070	98	TECBT80280	185	TEXBP50050	180	TEXBT50090	182	TEXZP40020	181
TBA208080	195	TCCC06080	98	TECBT80300	185	TEXBP50060	180	TEXBT50100	182	TEXZP40025	181
TBA2I0080	195	TCCC08060	98	TEGA25	282	TEXBP50070	180	TEXBT50120	182	TEXZP40030	181
TBR06050	195	TCCC08080	98	TEGA33	282	TEXBP50080	180	TEXBT60040	182	TEXZP40035	181
TBR06060	195	TCCC08100	98	TEGR2530	282	TEXBP50090	180	TEXBT60045	182	TEXZP40040	181
TBR06070	195	TCCC08120	98	TEM025	282	TEXBP50100	180	TEXBT60050	182	TEXZP40045	181
TBR08050	195	TCCC08140	98	TEM033	282	TEXBP50110	180	TEXBT60060	182	TEXZP40050	181
TBR08060	195	TCMA05022	70	TEPE2530	282	TEXBP50120	180	TEXBT60070	182	TEXZP40055	181
TBR08070	195	TCMA06030	70	TEXA250050	183	TEXBP60040	180	TEXBT60080	182	TEXZP40060	181
TBR08080	195	TCMA06040	70	TEXA250060	183	TEXBP60045	180	TEXBT60090	182	TEXZP40070	181
TBR10060	195	TCMA06050	70	TEXA250070	183	TEXBP60050	180	TEXBT60100	182	TEXZP40080	181
TBR10080	195	TCPA24213	175	TEXABM06	185	TEXBP60060	180	TEXBT60110	182	TEXZP45016	181
TC2A06060	97	TCPA24222	175	TEXABM08	185	TEXBP60070	180	TEXBT60120	182	TEXZP45020	181
TC2A08060	97	TCPA24232	175	TEXABM10	185	TEXBP60080	180	TEXBT60130	182	TEXZP45025	181
TC2A08080	97	TCPB4213	175	TEXABM10	185	TEXBP60090	180	TEXBT60140	182	TEXZP45030	181
TC2A08100	97	TCPB4222	175	TEXBP25012	180	TEXBP60100	180	TEXBT60150	182	TEXZP45035	181
TC2A08120	97	TCPB4232	175	TEXBP25016	180	TEXBP60110	180	TEXBT60160	182	TEXZP45040	181
TC2A10065	97	TCPN4213	175	TEXBP25020	180	TEXBP60120	180	TEXBT60180	182	TEXZP45045	181
TC2A10080	97	TCPN4222	175	TEXBP25025	180	TEXBT10080	182	TEXBT60200	182	TEXZP45050	181
TC2A10100	97	TCPN4232	175	TEXBP30010	180	TEXBT10100	182	TEXBT60220	182	TEXZP45060	181
TC2A10115	97	TCZ4213	175	TEXBP30012	180	TEXBT10120	182	TEXBT60240	182	TEXZP45070	181
TC2A10135	97	TCZ4222	175	TEXBP30015	180	TEXBT10140	182	TEXBT60260	182	TEXZP45080	181
TC2A10160	97	TCZ4232	175	TEXBP30016	180	TEXBT10160	182	TEXBT60280	182	TEXZP50025	181
TC6A08080	97	TCSOI4075	76	TEXBP30020	180	TEXBT10180	182	TEXBT60300	182	TEXZP50030	181
TC6A08100	97	TCSOI4100	76	TEXBP30025	180	TEXBT10200	182	TEXBT80080	182	TEXZP50035	181
TC6A08120	97	TCSOI4130	76	TEXBP30030	180	TEXBT10220	182	TEXBT80100	182	TEXZP50040	181
TC6A10100	97	TCSOI4160	76	TEXBP30035	180	TEXBT10240	182	TEXBT80120	182	TEXZP50045	181
TC6A10120	97	TCSOI6140	76	TEXBP30040	180	TEXBT30016	182	TEXBT80140	182	TEXZP50050	181
TC6A10140	97	TCSOI6160	76	TEXBP30045	180	TEXBT30020	182	TEXBT80160	182	TEXZP50060	181
TC6A10160	97	TCSOI6200	76	TEXBP35010	180	TEXBT30025	182	TEXBT80180	182	TEXZP50070	181
TC6A10200	97	TCSOI6240	76	TEXBP35012	180	TEXBT30030	182	TEXBT80200	182	TEXZP50080	181
TC6E08080	97	TCSP05027	98	TEXBP35015	180	TEXBT30035	182	TEXBT80220	182	TEXZP50090	181
TC6E08100	97	TCSP06032	98	TEXBP35016	180	TEXBT30040	182	TEXBT80240	182	TEXZP50100	181
TC6E08120	97	TCSP06040	98	TEXBP35020	180	TEXBT35012	182	TEXBT80260	182	TEXZP50110	181
TC6E10100	97	TCSP06032	98	TEXBP35025	180	TEXBT35016	182	TEXBT80280	182	TEXZP50120	181
TC6E10120	97	TCSP06032	98	TEXBP35030	180	TEXBT35020	182	TEXBT80300	182	TEXZP60040	181
TC6E10140	97	TCSP06040	98	TEXBP35035	180	TEXBT35025	182	TEXBT80320	182	TEXZP60045	181
TC6E10160	97	TDR2572025	162	TEXBP35040	180	TEXBT35030	182	TEXBT80340	182	TEXZP60050	181
TC6E10200	97	TDR2572032	162	TEXBP35045	180	TEXBT35035	182	TEXBT80360	182	TEXZP60060	181
TCA205030	98	TDR2572038	162	TEXBP35050	180	TEXBT35040	182	TEXBT80380	182	TEXZP60070	181
TCA206040	98	TE25050	109	TEXBP40012	180	TEXBT35045	182	TEXBT80400	182	TEXZP60080	181
TCA206060	98	TE25090	109	TEXBP40015	180	TEXBT35050	182	TEXZP25010	181	TEXZP60090	181
TCA208060	98	TECBT10100	185	TEXBP40016	180	TEXBT40016	182	TEXZP25012	181	TEXZP60100	181
TCA208080	98	TECBT10120	185	TEXBP40020	180	TEXBT40020	182	TEXZP25016	181	TEXZP60110	181
TCA208100	98	TECBT10140	185	TEXBP40025	180	TEXBT40025	182	TEXZP25020	181	TEXZP60120	181
TCCA05025	99	TECBT10160	185	TEXBP40030	180	TEXBT40030	182	TEXZP25025	181	TEXZT30016	183
TCCA05030	99	TECBT10180	185	TEXBP40035	180	TEXBT40035	182	TEXZP30010	181	TEXZT30020	183
TCCA05035	99	TECBT10200	185	TEXBP40040	180	TEXBT40040	182	TEXZP30012	181	TEXZT30025	183
TCCA05050	99	TECBT10220	185	TEXBP40045	180	TEXBT40045	182	TEXZP30015	181	TEXZT30030	183
TCCA06035	99	TECBT10240	185	TEXBP40050	180	TEXBT40050	182	TEXZP30016	181	TEXZT30035	183
TCCA06040	99	TECBT10260	185	TEXBP40055	180	TEXBT40055	182	TEXZP30020	181	TEXZT30040	183
TCCA06050	99	TECBT10280	185	TEXBP40060	180	TEXBT40060	182	TEXZP30025	181	TEXZT35012	183
TCCA06060	99	TECBT10300	185	TEXBP40070	180	TEXBT40070	182	TEXZP30030	181	TEXZT35016	183
TCCA06070	99	TECBT60080	185	TEXBP40080	180	TEXBT45025	182	TEXZP30035	181	TEXZT35020	183
TCCA06080	99	TECBT60100	185	TEXBP45016	180	TEXBT45030	182	TEXZP30040	181	TEXZT35025	183
TCCA08060	99	TECBT60120	185	TEXBP45020	180	TEXBT45035	182	TEXZP30045	181	TEXZT35030	183
TCCA08080	99	TECBT60140	185	TEXBP45025	180	TEXBT45040	182	TEXZP35010	181	TEXZT35035	183
TCCA08100	99	TECBT60160	185	TEXBP45030	180	TEXBT45045	182	TEXZP35012	181	TEXZT35040	183
TCCA08120	99	TECBT60180	185	TEXBP45035	180	TEXBT45050	182	TEXZP35015	181	TEXZT35045	183
TCCA08140	99	TECBT60200	185	TEXBP45040	180	TEXBT45060	182	TEXZP35016	181	TEXZT35050	183
TCCAEP5030	99	TECBT80080	185	TEXBP45045	180	TEXBT45070	182	TEXZP35020	181	TEXZT40016	183
TCCAEP6040	99	TECBT80100	185	TEXBP45050	180	TEXBT45080	182	TEXZP35025	181	TEXZT40020	183

Ref	pag	Ref	pag	Ref	pag	Ref	pag	Ref	pag
TEXZT40025	183	TFE10100	55	THA08060	53	TN4S06L	102	TPA240030	193
TEXZT40030	183	TFE10120	55	THA08080	53	TN4S08	100	TPA240040	193
TEXZT40035	183	TFE10140	55	THA08100	53	TN4S08EP	100	TPA240050	193
TEXZT40040	183	TFE12080	55	THA08120	53	TN4S08L	102	TPA245030	193
TEXZT40045	183	TFE12090	55	THA10100	53	TN4S10	100	TPA245050	193
TEXZT40050	183	TFE12110	55	THA10120	53	TN4S10EP	100	TPA250050	193
TEXZT40055	183	TFE12130	55	THE05040	53	TN4S10L	102	TPA250070	193
TEXZT40060	183	TFE12150	55	THE05050	53	TN4S12	100	TPAP352000	314
TEXZT40070	183	TFE14080	55	THE05060	53	TN4S14	100	TPAR251500	314
TEXZT45030	183	TFE14100	55	THE05080	53	TN4SA06	102	TPBLANC	57
TEXZT45035	183	TFE14120	55	THE05100	53	TN4SA06EP	102	TPCR042BL	243
TEXZT45040	183	TFE14130	55	THE06040	53	TNUX08060	96	TPCR042NE	243
TEXZT45050	183	TFE14140	55	THE06050	53	TNUX08080	96	TPCR048BL	243
TEXZT45060	183	TFE14160	55	THE06060	53	TNUX08100	96	TPCR048NE	243
TEXZT45070	183	TFE16100	55	THE06070	53	TNUX08120	96	TPCR055BL	243
TEXZT45080	183	TFE16150	55	THE06080	53	TNUX10060	96	TPCR055NE	243
TEXZT50030	183	TFE18100	55	THE06100	53	TNUX10080	96	TPMARRO	57
TEXZT50035	183	TFE18130	55	THE06120	53	TNUX10100	96	TPMTBL06	51
TEXZT50040	183	TFE18160	55	THE08055	53	TNUX10120	96	TPMTBL08	51
TEXZT50045	183	TFE18180	55	THE08060	53	TNUX10140	96	TPMTBL10	51
TEXZT50050	183	TFE18200	55	THE08070	53	TNUXA08060	95	TPMTBL12	51
TEXZT50060	183	TFE18200	55	THE08080	53	TNUXA08080	95	TPMTBL16	51
TEXZT50070	183	TFE18200	55	THE08090	53	TNUXA08100	95	TPMTNE06	51
TEXZT50080	183	TFE18200	55	THE08100	53	TNUXA08120	95	TPMTNE08	51
TEXZT50090	183	TFE18200	55	THE08110	53	TNUXA10060	95	TPMTNE10	51
TEXZT50100	183	TFE18200	55	THE08120	53	TNUXA10080	95	TPMTNE12	51
TEXZT60050	183	TFE18200	55	THE08140	53	TNUXA10100	95	TPMTNE16	51
TEXZT60060	183	TFE18200	55	THE10060	53	TNUXA10120	95	TPPO25010	188
TEXZT60070	183	TFE18200	55	THE10070	53	TNUXA10140	95	TPPO25012	188
TEXZT60080	183	TFE18200	55	THE10080	53	TNUXA10160	95	TPPO25016	188
TEXZT60090	183	TFE18200	55	THE10090	53	TNUXA10180	95	TPPO25020	188
TEXZT60100	183	TFE18200	55	THE10100	53	TNUXA10200	95	TPPO25025	188
TEXZT60110	183	TFE18200	55	THE10120	53	TNUXA10230	95	TPPO25025	188
TEXZT60120	183	TFE18200	55	THE10140	53	TNUXE08060	95	TPPO30012	188
TEXZT60130	183	TFE18200	55	THE12080	53	TNUXE08080	95	TPPO30016	188
TEXZT60140	183	TFE18200	55	THE12090	53	TNUXE08100	95	TPPO30020	188
TEXZT60150	183	TFE18200	55	THE12110	53	TNUXE08120	95	TPPO30025	188
TEXZT60160	183	TFE18200	55	THE12130	53	TNUXE08100	95	TPPO30030	188
TEXZT60180	183	TFE18200	55	THE12150	53	TNUXE08120	95	TPPO30030	188
TEXZT60200	183	TFE18200	55	THE14080	53	TNUXE10060	95	TPPO30040	188
TEXZT60220	183	TFE18200	55	THE14080	53	TNUXE10080	95	TPPO30040	188
TEXZT60240	183	TFE18200	55	THE14100	53	TNUXE10100	95	TPPO30012	188
TEXZT60260	183	TFE18200	55	THE14120	53	TNUXE10120	95	TPPO30016	188
TEXZT60280	183	TFE18200	55	THE14130	53	TNUXE10140	95	TPPO30020	188
TEXZT60300	183	TFE18200	55	THE14140	53	TNUXE10160	95	TPPO30025	188
TFE05040	55	TFE18200	55	THE14160	53	TNUXE10180	95	TPPO30030	188
TFE05050	55	TFE18200	55	THE16100	53	TNUXE10200	95	TPPO30040	188
TFE05060	55	TFE18200	55	THE16150	53	TNUXE10230	95	TPPO30012	188
TFE05080	55	TFE18200	55	THE18100	53	TNUXE10200	95	TPPO30016	188
TFE05100	55	TFE18200	55	THE18130	53	TNUXE10230	95	TPPO30020	188
TFE06040	55	TFE18200	55	THE18160	53	TNUXE10260	95	TPPO30025	188
TFE06050	55	TFE18200	55	THE18180	53	TNUXE10290	95	TPPO30030	188
TFE06060	55	TFE18200	55	THE18200	53	TNUXE10320	95	TPPO30030	188
TFE06070	55	TFE18200	55	THP05040	54	TNUXE10350	95	TPPO30040	188
TFE06080	55	TFE18200	55	THP05060	54	TNUXE10380	95	TPPO30040	188
TFE06100	55	TFE18200	55	THP06040	54	TNUXE10410	95	TPPO30050	188
TFE06120	55	TFE18200	55	THP06050	54	TNUXE10440	95	TPPO30012	188
TFE08055	55	TFE18200	55	THP06060	54	TNUXE10470	95	TPPO30016	188
TFE08060	55	TFE18200	55	THP06080	54	TNUXE10500	95	TPPO30020	188
TFE08070	55	TFE18200	55	THP06100	54	TNUXE10530	95	TPPO30025	188
TFE08080	55	TFE18200	55	THP08060	54	TNUXE10560	95	TPPO30030	188
TFE08090	55	TFE18200	55	THP08080	54	TNUXE10590	95	TPPO30030	188
TFE08100	55	TFE18200	55	THP08100	54	TNUXE10620	95	TPPO30040	188
TFE08110	55	TFE18200	55	THP08120	54	TNUXE10650	95	TPPO30040	188
TFE08120	55	TFE18200	55	THP08140	54	TNUXE10680	95	TPPO30050	188
TFE08140	55	TFE18200	55	THP08160	54	TNUXE10710	95	TPPO30012	188
TFE10060	55	TFE18200	55	THP08180	54	TNUXE10740	95	TPPO30016	188
TFE10070	55	TFE18200	55	THP08200	54	TNUXE10770	95	TPPO30020	188
TFE10080	55	TFE18200	55	THP08220	54	TNUXE10800	95	TPPO30025	188
TFE10090	55	TFE18200	55	THP08240	54	TNUXE10830	95	TPPO30030	188
		TFE18200	55	THP08260	54	TNUXE10860	95	TPPO30030	188
		TFE18200	55	THP08280	54	TNUXE10890	95	TPPO30040	188
		TFE18200	55	THP08300	54	TNUXE10920	95	TPPO30040	188
		TFE18200	55	THP08320	54	TNUXE10950	95	TPPO30050	188
		TFE18200	55	THP08340	54	TNUXE10980	95	TPPO30012	188
		TFE18200	55	THP08360	54	TNUXE11010	95	TPPO30016	188
		TFE18200	55	THP08380	54	TNUXE11040	95	TPPO30020	188
		TFE18200	55	THP08400	54	TNUXE11070	95	TPPO30025	188
		TFE18200	55	THP08420	54	TNUXE11100	95	TPPO30030	188
		TFE18200	55	THP08440	54	TNUXE11130	95	TPPO30030	188
		TFE18200	55	THP08460	54	TNUXE11160	95	TPPO30040	188
		TFE18200	55	THP08480	54	TNUXE11190	95	TPPO30040	188
		TFE18200	55	THP08500	54	TNUXE11220	95	TPPO30050	188
		TFE18200	55	THP08520	54	TNUXE11250	95	TPPO30012	188
		TFE18200	55	THP08540	54	TNUXE11280	95	TPPO30016	188
		TFE18200	55	THP08560	54	TNUXE11310	95	TPPO30020	188
		TFE18200	55	THP08580	54	TNUXE11340	95	TPPO30025	188
		TFE18200	55	THP08600	54	TNUXE11370	95	TPPO30030	188
		TFE18200	55	THP08620	54	TNUXE11400	95	TPPO30030	188
		TFE18200	55	THP08640	54	TNUXE11430	95	TPPO30040	188
		TFE18200	55	THP08660	54	TNUXE11460	95	TPPO30040	188
		TFE18200	55	THP08680	54	TNUXE11490	95	TPPO30050	188
		TFE18200	55	THP08700	54	TNUXE11520	95	TPPO30012	188
		TFE18200	55	THP08720	54	TNUXE11550	95	TPPO30016	188
		TFE18200	55	THP08740	54	TNUXE11580	95	TPPO30020	188
		TFE18200	55	THP08760	54	TNUXE11610	95	TPPO30025	188
		TFE18200	55	THP08780	54	TNUXE11640	95	TPPO30030	188
		TFE18200	55	THP08800	54	TNUXE11670	95	TPPO30030	188
		TFE18200	55	THP08820	54	TNUXE11700	95	TPPO30040	188
		TFE18200	55	THP08840	54	TNUXE11730	95	TPPO30040	188
		TFE18200	55	THP08860	54	TNUXE11760	95	TPPO30050	188
		TFE18200	55	THP08880	54	TNUXE11790	95	TPPO30012	188
		TFE18200	55	THP08900	54	TNUXE11820	95	TPPO30016	188
		TFE18200	55	THP08920	54	TNUXE11850	95	TPPO30020	188
		TFE18200	55	THP08940	54	TNUXE11880	95	TPPO30025	188
		TFE18200	55	THP08960	54	TNUXE11910	95	TPPO30030	188
		TFE18200	55	THP08980	54	TNUXE11940	95	TPPO30030	188
		TFE18200	55	THP09000	54	TNUXE11970	95	TPPO30040	188
		TFE18200	55	THP09020	54	TNUXE12000	95	TPPO30040	188
		TFE18200	55	THP09040	54	TNUXE12030	95	TPPO30050	188
		TFE18200	55	THP09060	54	TNUXE12060	95	TPPO30012	188
		TFE18200	55	THP09080	54	TNUXE12090	95	TPPO30016	188
		TFE18200	55	THP09100	54	TNUXE12120	95	TPPO30020	188
		TFE18200	55	THP09120	54	TNUXE12150	95	TPPO30025	188
		TFE18200	55	THP09140	54	TNUXE12180	95	TPPO30030	188
		TFE18200	55	THP09160	54	TNUXE12210	95	TPPO30030	188
		TFE18200	55	THP09180	54	TNUXE12240	95	TPPO30040	188
		TFE18200	55	THP09200	54	TNUXE12270	95	TPPO30040	188
		TFE18200	55	THP09220	54	TNUXE12300	95	TPPO30050	188
		TFE18200	55	THP09240	54	TNUXE12330	95	TPPO30012	188
		TFE18200	55	THP09260	54	TNUXE12360	95	TPPO30016	188
		TFE18200	55	THP09280	54	TNUXE12390	95	TPPO30020	188
		TFE18200	55	THP09300	54	TNUXE12420	95	TPPO30025	188
		TFE18200	55	THP09320	54	TNUXE12450	95	TPPO30030	188
		TFE18200	55	THP09340	54	TNUXE12480	95	TPPO30030	188
		TFE18200	55	THP09360	54	TNUXE12510	95	TPPO30040	188

Ref	pag	Ref	pag	Ref	pag	Ref	pag	Ref	pag	Ref	pag
TPPOZ50050	190	TPTPADHA	243	TRPO45020	193	TSVS30	127	VABE165532	155	VABR4238	164
TPPOZ50060	190	TPTPADNE	243	TRPO45025	193	TSVS36	127	VABE165538	155	VABR4250	164
TPPOZ50070	190	TPTPADNO	243	TRPO45030	193	TUG201006	302	VABE165550	155	VABR4813	164
TPPOZ50080	190	TPTPADPI	243	TRPO45035	193	TUG201008	302	VABE166325	155	VABR4816	164
TPPOZ50090	190	TPTPADRO	243	TRPO45040	193	TUG271808	302	VABE166332	155	VABR4819	164
TPPOZ50100	190	TPTPADSA	243	TRPO45045	193	TUG271810	302	VABE166338	155	VABR4822	164
TPPOZ50120	190	TRI3200200	141	TRPO50020	193	TUGRA2706	303	VABE3509	154	VABR4825	164
TPPOZ60040	190	TRI3300300	141	TRPO50030	193	TUGRA2708	303	VABE3513	154	VABR4832	164
TPPOZ60050	190	TRI3400400	141	TRPO50040	193	TUGRA3808	303	VABE4213	154	VABR4838	164
TPPOZ60060	190	TRI3500500	141	TRPO50050	193	TUGRA3810	303	VABE4216	154	VABR4845	164
TPPOZ60070	190	TRI3600600	141	TRPX5412515	314	TUCX08	306	VABE4219	154	VABR4850	164
TPPOZ60080	190	TRI5200200	141	TSAA05	126	TUGX10	306	VABE4225	154	VABR4860	164
TPPOZ60090	190	TRI5300300	141	TSAA06	126	TUCXMU08	306	VABE4232	154	VABR4880	164
TPPOZ60100	190	TRI5400400	141	TSAA08	126	TUCXMU10	306	VABE4813	154	VABR5532	164
TPPOZ60110	190	TRI5500500	141	TSAA10	126	TUMAM03	238	VABE4816	154	VACHA08C	65
TPTO30025	192	TRI5600600	141	TSAA12	126	TUMAM04	238	VABE4819	154	VACHA10C	65
TPTO30030	192	TRA6050	75	TSAA14	126	TUMAM05	238	VABE4825	154	VACHG08C	64
TPTO30515	192	TRA6060	75	TSAA16	126	TUMAM06	238	VABE4832	154	VACHG10C	64
TPTO35017	192	TRA6080	75	TSAA20	126	TUMAM08	238	VABE4838	154	VACHT08C	61
TPTO35020	192	TRA8070	75	TSAA22	126	TUMAM10	238	VABE5519	154	VACHT08L	61
TPTO35025	192	TRA8090	75	TSAA24	126	TUMAM12	238	VABE5522	154	VACHT10C	61
TPTO35030	192	TRA8110	75	TSAA30	126	TUMAM14	238	VABE5525	154	VACHTI0L	61
TPTO35040	192	TRA8130	75	TSAA36	126	TUMAM16	238	VABE5532	154	VACHTI2C	61
TPTO35050	192	TRA8150	75	TSAAA405	126	TURX08	306	VABE5538	154	VACHTI2L	61
TPTO40020	192	TRAV0411	121	TSAAA406	126	TURX10	306	VABE5550	154	VACHTI6C	61
TPTO40025	192	TRAV0513	121	TSAAA408	126	TURX12	306	VABE5563	154	VACHTA208C	61
TPTO40030	192	TRAV0616	121	TSAAA410	126	TURXA08	306	VABE6319	154	VACHTA208L	61
TPTO40035	192	TRAV0819	121	TSAAA412	126	TURXA10	306	VABE6325	154	VACHTA210C	61
TPTO40040	192	TRAV1021	121	TSGA05	126	TURXA208	313	VABE6332	154	VACHTA210L	61
TPTO40045	192	TRBL200200	141	TSGA06	126	TWA06060	51	VABE6338	154	VACHTA212C	61
TPTO40050	192	TRBL300300	141	TSGA08	126	TXE06040	54	VABE6350	154	VACHTA212L	61
TPTO40060	192	TRBL400400	141	TSGA10	126	TXE06060	54	VABE6363	154	VALHA14025	205
TPTO40070	192	TRBL500500	141	TSGA12	126	TXE08070	54	VABP3513	167	VALHA16030	205
TPTO45030	192	TRBL600600	141	TSGA14	126	TXE08080	54	VABP3516	167	VALHA17040	205
TPTO45035	192	TRCA0310	121	TSGA16	126	TXE08090	54	VABP3519	167	VALHA18040	205
TPTO45040	192	TRCA0410	121	TSGA20	126	TXE08105	54	VABP3525	167	VALHA18050	205
TPTO45045	192	TRCA0411	121	TSGA22	126	TXE10070	54	VABP3913	167	VALHA19050	205
TPTO45050	192	TRCA0512	121	TSGA24	126	TXE10090	54	VABP3916	167	VALHA19060	205
TPTO45060	192	TRCA0515	121	TSGA30	126	TXE10100	54	VABP3919	167	VALHA19070	205
TPTO45070	192	TRCA0614	121	TSGA36	126	TXE10120	54	VABP3925	167	VALHA20050	205
TPTO50030	192	TRCA0616	121	TSGAA405	126	TXE12080	54	VABP3938	167	VALHA20060	205
TPTO50035	192	TRCA0816	121	TSGAA406	126	TXE12110	54	VABP4213	167	VALHA20070	205
TPTO50040	192	TRCA0818	121	TSGAA410	126	TZN812909	171	VABP4216	167	VALHA20080	205
TPTO50045	192	TRCA1017	121	TSGAA412	126	TZN813513	171	VABP4219	167	VALHA21070	205
TPTO50050	192	TRCA1022	121	TSGG05	127	TZN813516	171	VABP4225	167	VALHA21080	205
TPTO50060	192	TRCA1223	121	TSGG06	127	TZN813519	171	VABP4232	167	VALHA21090	205
TPTO50070	192	TRCR0410	121	TSGG08	127	TZN813525	171	VABP4238	167	VALHA21100	205
TPTO50080	192	TRCR0511	121	TSGG10	127	TZN814216	171	VABP4816	167	VALHA22110	205
TPTO50090	192	TRCR0614	121	TSGG12	127	TZN814219	171	VABP4819	167	VALHA22120	205
TPTO50100	192	TRCR0815	121	TSGG14	127	TZN814225	171	VABP4825	167	VALHA23130	205
TPTO50120	192	TRCR1019	121	TSGG16	127	TZN814232	171	VABP4832	167	VALHAB16030	205
TPTO60060	192	TREP05050	197	TSGG20	127	TZN814238	171	VABP4838	167	VALHAB17040	205
TPTO60070	192	TREP07050	197	TSGG22	127	TZN814816	171	VABP5532	167	VALHAB18050	205
TPTO60080	192	TREZ05050	197	TSGG24	127	TZN814819	171	VABR3509	164	VALHAB19060	205
TPTO60090	192	TREZ07050	197	TSGG30	127	TZN814822	171	VABR3511	164	VALHC14025	204
TPTO60100	192	TRPO30016	193	TSGG36	127	TZN814825	171	VABR3513	164	VALHC16030	204
TPTO60110	192	TRPO30020	193	TSGGA405	127	TZN814838	171	VABR3516	164	VALHC17040	204
TPTO60120	192	TRPO35016	193	TSGGA406	127	TZN814850	171	VABR3519	164	VALHC18040	204
TPTO60130	192	TRPO35020	193	TSGGA408	127	UNCO3220	308	VABR3525	164	VALHC18050	204
TPTO60140	192	TRPO35025	193	TSGGA410	127	UNEX412103	307	VABR3913	164	VALHC19050	204
TPTO60150	192	TRPO35030	193	TSGGA412	127	UNPX412101	307	VABR3916	164	VALHC19060	204
TPTO60160	192	TRPO35035	193	TSVS06	127	UNPX412102	307	VABR3919	164	VALHC19070	204
TPTO60180	192	TRPO40016	193	TSVS08	127	UNPX412103	307	VABR3925	164	VALHC20050	204
TPTO60200	192	TRPO40020	193	TSVS10	127	UNPX412104	307	VABR3932	164	VALHC20060	204
TPTO60220	192	TRPO40025	193	TSVS12	127	UNTX412104	308	VABR4213	164	VALHC20070	204
TPTPADBE	243	TRPO40030	193	TSVS14	127	VABE144819	155	VABR4216	164	VALHC20080	204
TPTPADBL	243	TRPO40035	193	TSVS16	127	VABE144825	155	VABR4219	164	VALHC21070	204
TPTPADCA	243	TRPO40040	193	TSVS20	127	VABE164819	155	VABR4222	164	VALHC21080	204
TPTPADCE	243	TRPO40050	193	TSVS22	127	VABE165522	155	VABR4225	164	VALHC21090	204
TPTPADGR	243	TRPO45016	193	TSVS24	127	VABE165525	155	VABR4232	164	VALHC21100	204

Ref	pag	Ref	pag	Ref	pag	Ref	pag	Ref	pag	Ref	pag
VALHC22110	204	VDI2706	237	VD91206040	227	VD93310040	223	VINCO432	114	VRENO4810	118
VALHC22120	204	VDI2708	237	VD91206050	227	VD93310050	223	VINCO438	114	VRENO4812	118
VALHC23130	204	VDI2710	237	VD91206060	227	VD93310060	223	VINCO446	114	VRENO4814	118
VALRE25020	202	VDI2712	237	VD91208010	227	VD93310070	223	VINCO537	114	VRENO4816	118
VALRE25030	202	VDI58704	234	VD91208016	227	VD93310080	223	VINCO552	114	VRENO4818	118
VALRE35040	202	VDI58705	234	VD91208020	227	VD93312030	223	VINCO637	114	VRENO4820	118
VALRE35050	202	VDI58706	234	VD91208030	227	VD93312040	223	VINCO652	114	VRENO4822	118
VALRE40060	202	VDI58708	234	VD91208040	227	VD93312050	223	VINVN7060	196	VRENO4824	118
VALRE40070	202	VDI58710	234	VD91208050	227	VD93312060	223	VINVN7070	196	VRENO4830	118
VALRE40080	202	VDI58712	234	VD91208060	227	VD93312070	223	VINVZ7060	195	VRENO4835	118
VALRO14025	203	VD603905020	228	VD93106030	225	VD93312080	223	VINVZ7070	195	VRSE06020	327
VALRO16030	203	VD603905030	228	VD93106040	225	VD933104010	224	VMAE0630	327	VRSE06030	327
VALRO17040	203	VD603905040	228	VD93106050	225	VD933104016	224	VMAE0825	327	VRSE08020	327
VALRO18040	203	VD603905050	228	VD93106060	225	VD933104020	224	VMAEI030	327	VRSE08030	327
VALRO18050	203	VD603906016	228	VD93106070	225	VD933104030	224	VMAR0420	328	VRSEI0030	327
VALRO19050	203	VD603906020	228	VD93108030	225	VD933104040	224	VMAR0630	328	VRSEI2030	327
VALRO19060	203	VD603906030	228	VD93108040	225	VD933105010	224	VMAR0830	328	VSVCLB	209
VALRO19070	203	VD603906040	228	VD93108050	225	VD933105016	224	VMAR1030	328	VSVCMMA	209
VALRO20060	203	VD603906050	228	VD93108060	225	VD933105020	224	VMI08075	48	VSVNB01	209
VALRO20070	203	VD603906060	228	VD93108070	225	VD933105030	224	VMI08090	48	VSVNB02	209
VALRO20080	203	VD603906070	228	VD93108080	225	VD933105040	224	VMI10070	48	VSVNM01	209
VALRO21080	203	VD603906080	228	VD93110040	225	VD933105050	224	VMI10090	48	VSVNM02	209
VALRO21090	203	VD603908025	228	VD93110050	225	VD933106010	224	VMI10120	48	VT8135009	172
VALRO22100	203	VD603908030	228	VD93110060	225	VD933106016	224	VMI12110	48	VT8135013	172
VALRO22110	203	VD603908040	228	VD93110070	225	VD933106020	224	VMIA408075	48	VT8135016	172
VALRO22120	203	VD603908050	228	VD93110080	225	VD933106025	224	VMIA410090	48	VT8135019	172
VALRO23130	203	VD603908060	228	VD93112050	225	VD933106030	224	VMIA412110	48	VT8135025	172
VALROB16030	203	VD603908070	228	VD93112060	225	VD933106040	224	VMPF050	220	VT8139009	172
VALROB17040	203	VD603908080	228	VD93112070	225	VD933106050	224	VPAC15015	207	VT8139013	172
VALROB18050	203	VD603908090	228	VD93112080	225	VD933108016	224	VPACC15020	207	VT8139016	172
VALROB19060	203	VD603908100	228	VD93304008	223	VD933108020	224	VPACC15025	207	VT8139019	172
VAM06060	49	VD603910025	228	VD93304010	223	VD933108025	224	VPACC20025	207	VT8139022	172
VAM08075	49	VD603910030	228	VD93304012	223	VD933108030	224	VPACC20030	207	VT8139025	172
VAM08090	49	VD603910040	228	VD93304016	223	VD933108040	224	VPACC20035	207	VT8142009	172
VAM10070	49	VD603910050	228	VD93304020	223	VD933108050	224	VPACC20040	207	VT8142013	172
VAM10090	49	VD603910060	228	VD93304025	223	VD933108060	224	VPACC20045	207	VT8142016	172
VAM10120	49	VD603910070	228	VD93304030	223	VD93310020	224	VPACC20050	207	VT8142019	172
VAM12090	49	VD603910080	228	VD93304040	223	VD93310030	224	VPAESM04	113	VT8142022	172
VAM12110	49	VD902103	236	VD93304050	223	VD933110040	224	VPAESM05	113	VT8142025	172
VARANE14	161	VD902104	236	VD93304060	223	VD933110050	224	VPAESM06	113	VT8142032	172
VARANE16	161	VD902105	236	VD93305010	223	VD933110060	224	VPAGAM04	113	VT8142038	172
VARANE18	161	VD902106	236	VD93305012	223	VD93403	232	VPAGAM05	113	VT8142050	172
VARANE25	161	VD902108	236	VD93305016	223	VD93404	232	VPAGAM06	113	VT8148009	172
VBAESM04	112	VD902110	236	VD93305020	223	VD93405	232	VPL35025	136	VT8148013	172
VBAESM05	112	VD902112	236	VD93305025	223	VD93406	232	VPL35035	136	VT8148016	172
VBAESM06	112	VD90211M04	236	VD93305030	223	VD93408	232	VPL35045	136	VT8148019	172
VBAGAM04	112	VD90211M05	236	VD93305040	223	VD93410	232	VRECA4010	119	VT8148025	172
VBAGAM05	112	VD90211M06	236	VD93305050	223	VD93412	232	VRECA4012	119	VT8148032	172
VBAGAM06	112	VD90211M08	236	VD93305060	223	VD9341M04	232	VRECA4016	119	VT8148038	172
VCABA004	112	VD90211M10	236	VD93305070	223	VD9341M05	232	VRECA4810	119	VT8148045	172
VCABA005	112	VD91204010	227	VD93306016	223	VD9341M06	232	VRECA4812	119	VT8148050	172
VCABA006	112	VD91204012	227	VD93306020	223	VD9341M08	232	VRECA4814	119	VT8148060	172
VCAPA004	113	VD91204020	227	VD93306025	223	VD9341M10	232	VRECA4816	119	VT8148070	172
VCAPA005	113	VD91204030	227	VD93306030	223	VD9851M04	233	VRECA4818	119	VT8148080	172
VCAPA006	113	VD91204040	227	VD93306040	223	VD9851M05	233	VREFL4835	120	VT8155019	172
VCFBL	208	VD91204050	227	VD93306050	223	VD9851M06	233	VRENO3206	118	VT8155025	172
VDI2503	235	VD91205010	227	VD93306060	223	VD9851M08	233	VRENO3208	118	VT8155032	172
VDI2504	235	VD91205012	227	VD93306070	223	VD9851M10	233	VRENO3210	118	VT8155038	172
VDI2505	235	VD91205016	227	VD93308016	223	VDZ98503	233	VRENO3212	118	VT8235009	173
VDI2506	235	VD91205020	227	VD93308020	223	VDZ98504	233	VRENO3214	118	VT8235013	173
VDI2508	235	VD91205025	227	VD93308025	223	VDZ98505	233	VRENO3218	118	VT8235016	173
VDI2510	235	VD91205030	227	VD93308030	223	VDZ98506	233	VRENO4006	118	VT8235019	173
VDI2512	235	VD91205040	227	VD93308040	223	VDZ98508	233	VRENO4008	118	VT8235025	173
VDI251M04	235	VD91205050	227	VD93308050	223	VDZ98510	233	VRENO4010	118	VT8239016	173
VDI251M05	235	VD91206010	227	VD93308060	223	VDZ98512	233	VRENO4012	118	VT8239019	173
VDI251M06	235	VD91206012	227	VD93308070	223	VGMZ10016	208	VRENO4014	118	VT8239022	173
VDI251M08	235	VD91206016	227	VD93308080	223	VGMZ15026	208	VRENO4016	118	VT8239025	173
VDI251M10	235	VD91206020	227	VD93308100	223	VGMZ19035	208	VRENO4018	118	VT8242016	173
VDI2704	237	VD91206025	227	VD93310020	223	VHENOM06	68	VRENO4020	118	VT8242019	173
VDI2705	237	VD91206030	227	VD93310030	223	VHENOM08	68	VRENO4808	118	VT8242025	173

Ref	pag	Ref	pag	Ref	pag	Ref	pag	Ref	pag
VT8242032	173	VTB10090	194	VTEXZP40030	181	VTPPO30020	189	VTPT050060	192
VT8248019	173	VTB10100	194	VTEXZP40035	181	VTPPO30025	189	VTPT050070	192
VT8248025	173	VTBTS08	101	VTEXZP40040	181	VTPPO30030	189	VTPT050080	192
VT8248032	173	VTBTS10	101	VTEXZP40045	181	VTPPO30040	189	VTPT050090	192
VT8248038	173	VTBTS12	101	VTEXZP40050	181	VTPPO35016	189	VTPT060060	192
VT8255032	173	VTCCA05025	99	VTEXZP40060	181	VTPPO35020	189	VTPT060070	192
VT8255038	173	VTCCA05030	99	VTEXZP45030	181	VTPPO35025	189	VTPT060080	192
VT9650306Z	231	VTCCA05035	99	VTEXZP45035	181	VTPPO35030	189	VTREP05050	197
VT9650310Z	231	VTCCA05050	99	VTEXZP45040	181	VTPPO35035	189	VTREP07050	197
VT9650408Z	231	VTCCA06035	99	VTEXZP45045	181	VTPPO35040	189	VTREZ05050	197
VT9650410Z	231	VTCCA06040	99	VTEXZP45050	181	VTPPO35050	189	VTREZ07050	197
VT9650416Z	231	VTCCA06050	99	VTEXZP45060	181	VTPPO40016	189	VTUMAM03	238
VT9650420Z	231	VTCCA06060	99	VTEXZP45070	181	VTPPO40020	189	VTUMAM04	238
VT9650425Z	231	VTCCA06070	99	VTEXZP50030	181	VTPPO40025	189	VTUMAM05	238
VT9650430Z	231	VTCCA08060	99	VTEXZP50035	181	VTPPO40030	189	VTUMAM06	238
VT9650510Z	231	VTCCA08080	99	VTEXZP50040	181	VTPPO40035	189	VTUMAM08	238
VT9650516Z	231	VTEXA250050	183	VTEXZP50045	181	VTPPO40040	189	VTUMAM10	238
VT9650520Z	231	VTEXA250060	183	VTEXZP50050	181	VTPPO40045	189	VTUMAM12	238
VT9650530Z	231	VTEXA250070	183	VTEXZP50060	181	VTPPO40050	189	ZP06C40	72
VT9650540Z	231	VTEXBP30016	180	VTEXZP50070	181	VTPPO40060	189	ZP08C15	72
VT9650610Z	231	VTEXBP30020	180	VTEXZP50080	181	VTPPO45030	189	ZP08C45	72
VT9650616Z	231	VTEXBP30025	180	VTEXZP60050	181	VTPPO45035	189	ZPI0C50	72
VT9650620Z	231	VTEXBP30030	180	VTEXZP60060	181	VTPPO45040	189	ZPI0C80	72
VT9650630Z	231	VTEXBP30040	180	VTEXZP60070	181	VTPPO45045	189	ZPI2C15	72
VT9850306Z	230	VTEXBP35016	180	VTEXZP60080	181	VTPPO45050	189	ZPI2C65	72
VT9850310Z	230	VTEXBP35020	180	VTNUXA08080	95	VTPPO45060	189	ZT06L10	72
VT9850316Z	230	VTEXBP35025	180	VTNUXA08100	95	VTPPO45070	189	ZT06L30	72
VT9850320Z	230	VTEXBP35030	180	VTNUXAI0080	95	VTPPO50030	189	ZT08L15	72
VT9850330Z	230	VTEXBP35035	180	VTNUXAI0100	95	VTPPO50035	189	ZT08L35	72
VT9850406Z	230	VTEXBP35040	180	VTNUXE08080	95	VTPPO50040	189	ZT08L45	72
VT9850408Z	230	VTEXBP35050	180	VTNUXE08100	95	VTPPO50050	189	ZT10L10	72
VT9850410Z	230	VTEXBP40025	180	VTNUXE10080	95	VTPPO50060	189	ZT10L30	72
VT9850416Z	230	VTEXBP40030	180	VTNUXE10100	95	VTPPO50070	189	ZT10L50	72
VT9850420Z	230	VTEXBP40035	180	VTPOZ30025	191	VTPPO50080	189	ZT10L80	72
VT9850506Z	230	VTEXBP40040	180	VTPOZ30030	191	VTPPO50090	189	ZT12L15	72
VT9850510Z	230	VTEXBP40045	180	VTPOZ35016	191	VTPPO60040	189	ZT12L45	72
VT9850512Z	230	VTEXBP40050	180	VTPOZ35020	191	VTPPO60050	189	ZT12L65	72
VT9850516Z	230	VTEXBP40060	180	VTPOZ35025	191	VTPPO60060	189		
VT9850520Z	230	VTEXBP45030	180	VTPOZ35030	191	VTPPO60070	189		
VT9850530Z	230	VTEXBP45035	180	VTPOZ35035	191	VTPPO60080	189		
VT9850540Z	230	VTEXBP45040	180	VTPOZ35040	191	VTPPOTS05	101		
VT9850550Z	230	VTEXBP45045	180	VTPOZ35050	191	VTPPOTS06	101		
VT9850610Z	230	VTEXBP45050	180	VTPOZ40016	191	VTPPOTS08	101		
VT9850612Z	230	VTEXBP45060	180	VTPOZ40020	191	VTPT030025	192		
VT9850616Z	230	VTEXBP45070	180	VTPOZ40025	191	VTPT030030	192		
VT9850620Z	230	VTEXBP50030	180	VTPOZ40030	191	VTPT035015	192		
VT9850630Z	230	VTEXBP50035	180	VTPOZ40035	191	VTPT035020	192		
VT9850640Z	230	VTEXBP50040	180	VTPOZ40040	191	VTPT035025	192		
VT9850650Z	230	VTEXBP50050	180	VTPOZ40045	191	VTPT035030	192		
VT9850660Z	230	VTEXBP50060	180	VTPOZ40050	191	VTPT035040	192		
VTALAM06	69	VTEXBP50070	180	VTPOZ40060	191	VTPT035050	192		
VTALAM08	69	VTEXBP50080	180	VTPOZ45030	191	VTPT040020	192		
VTALAM10	69	VTEXBP50090	180	VTPOZ45035	191	VTPT040025	192		
VTB05040	194	VTEXBP60050	180	VTPOZ45040	191	VTPT040030	192		
VTB05050	194	VTEXBP60060	180	VTPOZ45045	191	VTPT040035	192		
VTB06040	194	VTEXBP60070	180	VTPOZ45050	191	VTPT040040	192		
VTB06050	194	VTEXBP60080	180	VTPOZ45060	191	VTPT040045	192		
VTB06060	194	VTEXZP30016	181	VTPOZ45070	191	VTPT040050	192		
VTB07050	194	VTEXZP30020	181	VTPOZ50030	191	VTPT040060	192		
VTB07060	194	VTEXZP30025	181	VTPOZ50035	191	VTPT045030	192		
VTB07070	194	VTEXZP30030	181	VTPOZ50040	191	VTPT045035	192		
VTB07080	194	VTEXZP30040	181	VTPOZ50050	191	VTPT045040	192		
VTB08050	194	VTEXZP35016	181	VTPOZ50060	191	VTPT045045	192		
VTB08060	194	VTEXZP35020	181	VTPOZ50070	191	VTPT045050	192		
VTB08070	194	VTEXZP35025	181	VTPOZ50080	191	VTPT045060	192		
VTB08080	194	VTEXZP35030	181	VTPOZ50090	191	VTPT045070	192		
VTB08090	194	VTEXZP35035	181	VTPOZ60060	191	VTPT050030	192		
VTB08100	194	VTEXZP35040	181	VTPOZ60070	191	VTPT050035	192		
VTB10070	194	VTEXZP35050	181	VTPOZ60080	191	VTPT050040	192		
VTB10080	194	VTEXZP40025	181	VTPPO30016	189	VTPT050050	192		



Handwriting practice area consisting of 20 horizontal dotted lines.

A series of horizontal dotted lines for taking notes.

A
PERFECT
FIXING

CATINDEX23



Técnicas Expansivas S.L.

P. I. La Portalada II, C/ Segador, 13
26006 · Logroño (La Rioja) · SPAIN

T. (+34) 941.272.131 · E. info@indexfix.com
www.indexfix.com